



IDCT 533

Industrial Pressure Transmitter with IO-Link Interface

Stainless Steel Sensor

accuracy according to IEC 60770:
standart: $\leq \pm 0.35\%$ FSO
option: $\leq \pm 0.25\%$ FSO

Nominal pressure

from 0 ... 100 mbar up to 0 ... 400 bar

Digital output signals

- IO-Link according to specification V 1.1
- Data transfer 38.4 kBaud
- Smart sensor profile

Special characteristic

- ▶ perfect thermal behaviour
- ▶ excellent long term stability

Optional versions

- ▶ pressure port
G 1/2" flush up to 40 bar
- ▶ welded sensor
- ▶ customer specific versions

IO-Link is a digital interface for sensors and actuators, which is worldwide standardized by IEC 61131-9. IO-Link does not have a bus topology, but it is a powerful point-to-point communication, where the device can be parametrized and the measured values transferred. The integration to the master is easy by using the IODD-file.

The sensor technology of the IDCT 533 is the same as those of the proven pressure transmitter DMP 331 / DMP 333, whereby the IDCT 533 is suitable for almost every industrial application, if medium is compatible with stainless steel 316L.

The modular concept of the pressure transmitter allows customized electrical or mechanical connections, so it is easy to adapt the IDCT 533 to different conditions on-site.

Preferred areas of use are



Plant and Machine Engineering



Energy Industry



IO-Link

Input pressure range													
Nominal pressure gauge	[bar]	-1...0	0,10	0,16	0,25	0,40	0,60	1	1,6	2,5	4	6	
Nominal pressure abs.	[bar]	-	-	-	-	0,40	0,60	1	1,6	2,5	4	6	
Overpressure	[bar]	5	0,5	1	1	2	5	5	10	10	20	40	
Burst pressure ≥	[bar]	7,5	1,5	1,5	1,5	3	7,5	7,5	15	15	25	50	
Nominal pressure gauge / abs.	[bar]	10	16	25	40	60	100	160	250	400			
Overpressure	[bar]	40	80	80	105	210	600	600	1000	1000			
Burst pressure ≥	[bar]	50	120	120	210	420	1000	1000	1250	1250			
Vacuum resistance		P _N ≥ 1 bar: unlimited vacuum resistance					P _N < 1 bar: on request						
Output signal / Supply													
Standard		IO-Link (measured value transmission) V _S = 18 ... 30 V _{DC} SIO (switching output)											
IO-Link		V 1.1 / Slave / Smart Sensor Profile											
Data transfer		COM 2 38,4 kBaud											
Mode		SIO / IO-Link											
Standard		IEC 61131-9											
Performance													
Accuracy ¹		standard for P _N ≥ 0.4 bar: ≤ ± 0.35 % FSO standard for P _N < 0.4 bar: ≤ ± 0.5 % FSO option for P _N ≥ 0.4 bar: ≤ ± 0.25 % FSO											
Switching current (SIO-Mode)		max. 200 mA											
switchingfrequency		max. 200 Hz											
Switching cycles		> 100 x 10 ⁶											
Long term stability		≤ ± 0.1 % FSO / year at reference conditions											
Turn-on time		SIO-Modus: ca. 20 ms											
Response time		SIO-Modus: < 4 ms											
Measuring rate		400 Hz											
¹ accuracy according to IEC 60770 – limit point adjustment (non-linearity, hysteresis, repeatability)													
Thermal effects (Offset and Span)													
Nominal pressure P _N	[bar]	-1 ... 0				< 0.40				≥ 0.40			
Tolerance band	[% FSO]	≤ ± 0.75				≤ ± 1				≤ ± 0.75			
in compensated range	[°C]	-20 ... 85				0 ... 70				-20 ... 85			
Permissible temperatures													
Permissible temperatures		medium: -25 ... 125 °C				electronics / environment: -25 ... 85 °C				storage: -40 ... 85 °C			
Electrical protection													
Short-circuit protection		permanent											
Reverse polarity protection		no damage, but also no function											
Electromagnetic compatibility		emission and immunity according to EN 61326											
Mechanical stability													
Vibration		10 g RMS (25 ... 2000 Hz) according to DIN EN 60068-2-6											
Shock		500 g / 1 msec according to DIN EN 60068-2-27											
Materials													
Pressure port / housing		stainless steel 1.4404 (316 L)											
Seals (media wetted)		standard: FKM options: EPDM welded version ² (for P _N ≤ 40 bar) others on request											
Diaphragm		stainless steel 1.4435 (316 L)											
Media wetted parts		pressure port, seal, diaphragm											
² welded version only with pressure ports according to EN 837, P _N ≤ 40 bar													
Miscellaneous													
Current consumption		< 20 mA											
Weight		approx. 140 g											
Installation position		any ³											
Protection class		IP 67											
Operational life		> 100 x 10 ⁶ pressure cycles											
CE-conformity		EMC Directive: 2014/30/EU					Pressure Equipment Directive: 2014/68/EU (module A) ⁴						
³ Pressure transmitters are calibrated in a vertical position with the pressure connection down. If this position is changed on installation there can be slight deviations in the zero point for pressure ranges P _N ≤ 1 bar.													
⁴ This directive is only valid for devices with maximum permissible overpressure > 200 bar													

IDCT 533

Industrial Pressure Transmitter with IO Link interface

Technical Data

Wiring diagrams

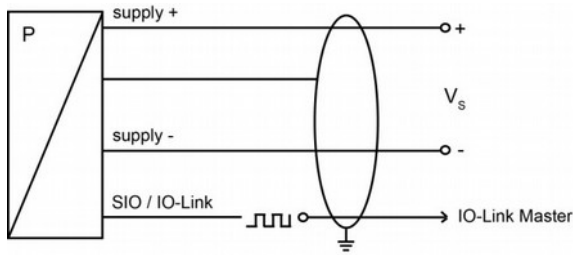

Pin configuration

Electrical connection	M12x1 / metal (4-pin)	cable colour (IEC 60757)
Supply +	1	wh (white)
Supply -	3	bn (brown)
SIO / IO Link	4	gn (green)
Shield	housing	gnye (green-yellow)

Electrical connections (dimensions in mm)

standard

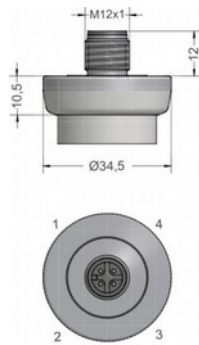

M12x1 4-pin (IP 67)

option

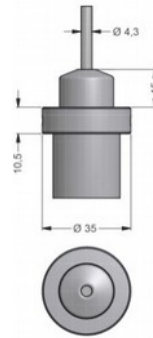

cable outlet with PVC cable (IP 67)⁵

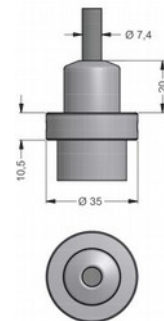

cable outlet, cable with ventilation tube (IP 68)⁶

⁵ standard: 2 m PVC cable without ventilation tube (permissible temperature: -5 ... 70°C)

⁶ different cable types and lengths available, permissible temperature depends on kind of cable

Mechanische Anschlüsse (Maße in mm)

standard

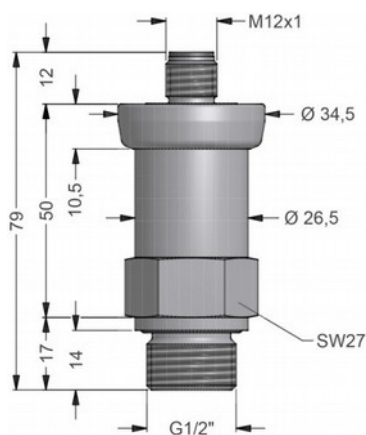

G1/2" DIN 3852 with M12x1

IDCT 533

Industrial Pressure Transmitter with IO Link interface

Technical Data

Mechanical connections (dimensions in mm)

option

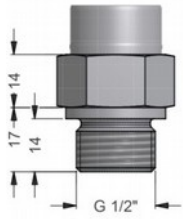

G1/4" DIN 3852

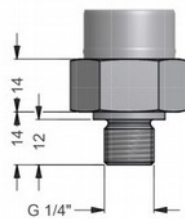

G1/2" DIN 3852 open port,
 $P_N \leq 40$ bar

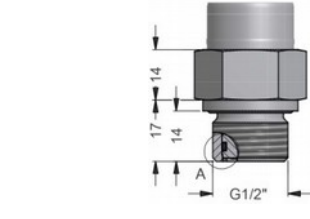
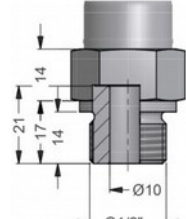

G1/2" DIN 3852
with flush sensor, $P_N \leq 40$ bar

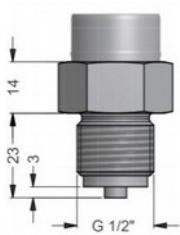

G1/2" EN 837

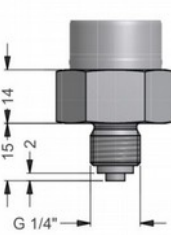
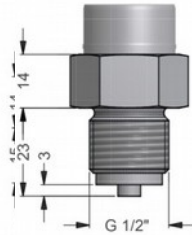

G1/4" EN 837

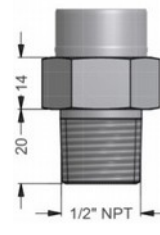

1/2" NPT

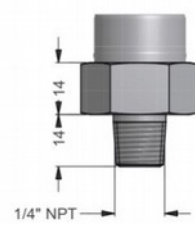

1/4" NPT

metric threads and other versions on request

Ordering code IDCT 533
IDCT 533

Pressure									
gauge	D	C	2						
absolute ¹	D	C	3						
Input									
[bar]									
0.1 ¹	1	0	0	0					
0.16 ¹	1	6	0	0					
0.25 ¹	2	5	0	0					
0.4	4	0	0	0					
0.6	6	0	0	0					
1	1	0	0	1					
1.6	1	6	0	1					
2.5	2	5	0	1					
4	4	0	0	1					
6	6	0	0	1					
10	1	0	0	2					
16	1	6	0	2					
25	2	5	0	2					
40	4	0	0	2					
60	6	0	0	2					
100	1	0	0	3					
160	1	6	0	3					
250	2	5	0	3					
400	4	0	0	3					
-1 ... 0	X	1	0	2					
customer	9	9	9	9					consult
Output									
IO-Link / SIO									IO
Accuracy									
standard for P _N ≥ 0.4 bar	0.35 %								3
standard for P _N < 0.4 bar	0.5 %								5
option for P _N ≥ 0.4 bar	0.25 %								2
customer									9
Electrical connection									
Male plug M12x1 (4-pin) / metal									M 1 7
Cable outlet with PVC cable ²									T A 0
Cable outlet (IP68) ³									T R 0
customer									9 9 9
Mechanical connection									
G1/2" DIN 3852									1 0 0
G1/2" EN 837									2 0 0
G1/4" DIN 3852									3 0 0
G1/4" EN 837									4 0 0
G1/2" DIN 3852 with flush sensor ⁴									F 0 0
G1/2" DIN 3852 open pressure port ⁴									H 0 0
1/2" NPT									N 0 0
1/4" NPT									N 4 0
customer									9 9 9
Seals									
FKM									1
EPDM									3
without (welded version) ⁵									2
customer									9
Special version									
standard									0 0 0
customer									9 9 9
									consult

¹ absolute pressure possible from 0.4 bar

² standard: 2 m PVC cable without ventilation tube (permissible temperature: -5 ... 70°C), others on request

³ cable with ventilation tube (code TR0 = PVC cable), different cable types and lengths available, price without cable

⁴ not possible for nominal pressure P_N > 40 bar

⁵ welded version only with pressure ports according to EN 837, possible for P_N ≤ 40 bar