

# Operating manual Electronic Suspending Balance

## Logbook Regular maintenance and care

### **KERN CH**

Version 3.5  
07/2016  
GB



**CH-BA-e-1635**



# KERN CH

Version 3.5 07/2016

## Operating instructions / Logbook Electronic Suspending Balance

### Contents

1.	Technical data	3
1.1	Dimensions	4
2.	General Safety Instructions	5
2.1	Duties of the owner-operator	5
2.2	Organizational measures	5
2.3	Environmental conditions	5
2.4	Pay attention to the instructions in the Operation Manual	6
2.5	Proper use	6
2.6	Improper Use	6
2.7	Warranty	6
2.8	Safe working	7
2.9	Monitoring of Test Resources	7
2.10	Testing upon acceptance	7
2.11	Initial Commissioning	7
2.12	Shutdown and storage	7
3.	The suspended balance at a glance	8
3.1	Overview	8
3.2	Overview visual displays and keyboard	10
3.3	Label	11
4.	Commissioning	12
4.1	Unpacking	12
4.2	Scope of delivery	12
4.3	Checking the original dimensions	13
4.4	Battery operation	13
5.	Operation	14
5.1	Safety instructions	14
5.2	Loading the suspended balance	16
5.3	Turn on/off	18
5.4	Taring	18
5.5	Weighing	18
5.6	Switch-over weighing unit	19
5.7	Functions	19
6.	Menu	21
7.	Adjustment	22
8.	Cleaning, Maintenance and Disposal	23
8.1	Cleaning and Disposal	23
8.2	Regular maintenance and care	24
8.3	Checklist „Regular maintenance“	26
9.	Enclosure	29
9.1	Checklist „Enhanced maintenance“ (General revision)	29
10.	Declaration of conformity	30

## 1. Technical data

<b>KERN</b>	<b>CH 15K20</b>	<b>CH 50K50</b>	<b>CH 50K100</b>
Readability (d)	20 g	50 g	100 g
Weighing range (max)	15 kg	50 kg	50 kg
Taring range (subtractive)	15 kg	50 kg	50 kg
Reproducibility	20 g	50 g	100 g
Linearity	± 40 g	± 100 g	± 200 g
Recommended adjustment weight, not added (class)	10 kg (M3)	20 kg (M3)	20 kg (M3)
Stabilization time	2 s		
Precision	0.5 % of max.		
Warm-up time	10 min		
Units	kg, lb, N		
Auto off	3 min		
Allowable ambient temperature	5...+ 35 °C		
Ambient humidity (max)	80 %		
Battery (in series)	1 x 9 V Block Operating time 20 h		
Display	Digit height 11 mm		
Housing size W x D x H	90 mm x 30 mm x 176.5 mm		
Housing material	Synthetic material		
Material Hook	Stainlees steel		
Net weight	250 g		

## 1.1 Dimensions

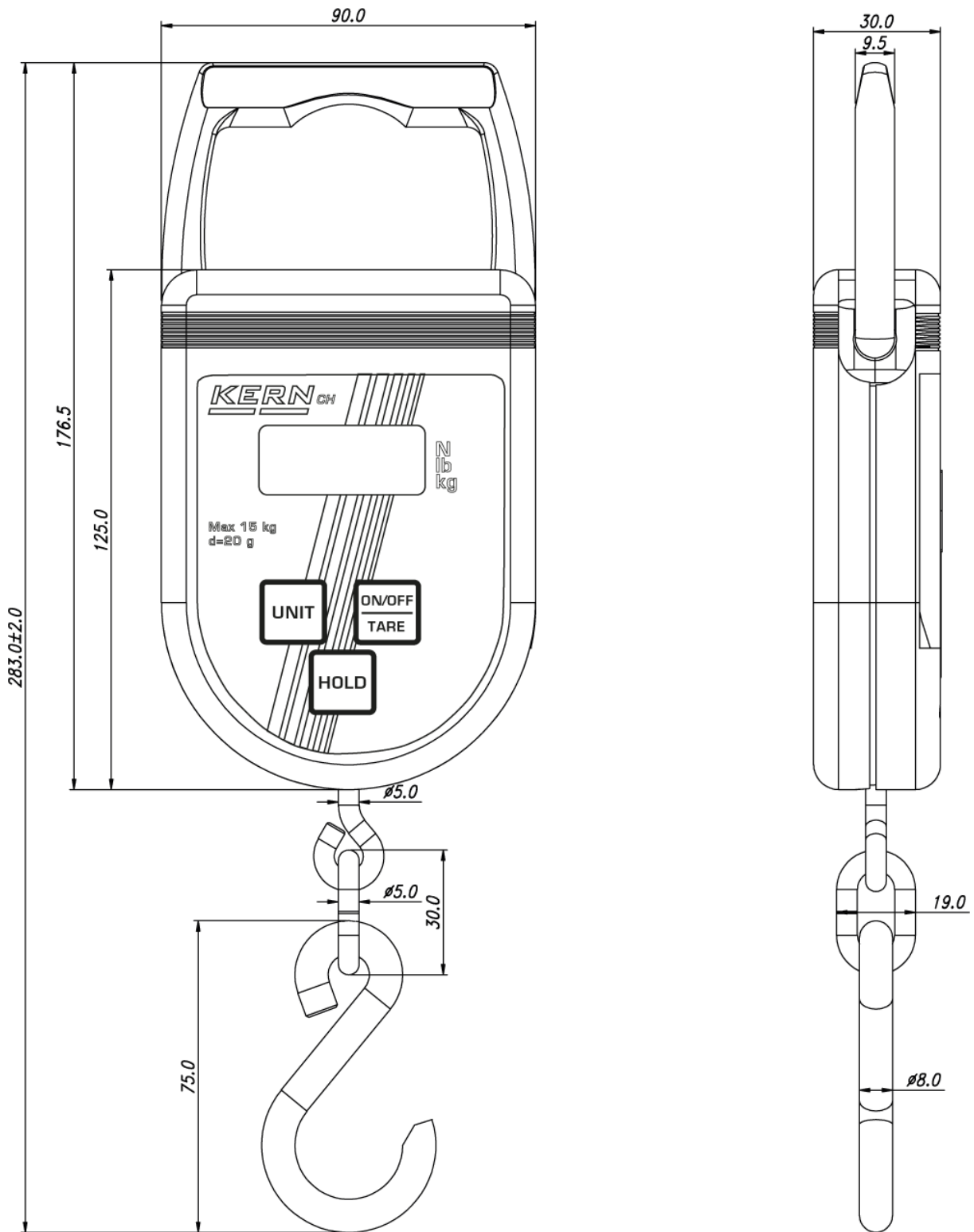

## **2. General Safety Instructions**

### **2.1 Duties of the owner-operator**

**Follow national accident prevention regulations and all operator health and safety at work and operating regulations.**

- The balance may only be used for the proposed purpose. Any type of use which is not specified in these operating instructions, will be considered as improper use. The customer is solely responsible for material damage and injury of persons resulting from an improper use, Messrs. KERN & Sohn will not be liable under any circumstance.  
Messrs. KERN & Sohn cannot be held liable, if the suspended balance is modified or used improperly and if damage is resulting from such use.
- Inspect and service suspended balance and load suspension device regularly (see chap. 8.3).
- Log the test result and keep it in the logbook.

### **2.2 Organizational measures**

- Only trained and instructed staff may operate the balance.
- Make sure that the operating instructions are kept nearby the operation site of the suspended balance.
- Assembly, commissioning and maintenance should only be carried out by trained specialists.
- Weight-bearing components must not be replaced

### **2.3 Environmental conditions**

- Never operate suspended balance in spaces exposed to explosion hazards. The serial version is not explosion protected.
- Operate the suspended balance only under environmental conditions as specified in these operating instructions (especially in chapter 1 „Technical data“).
- Do not expose the suspended balance to strong humidity. Non-permitted condensation (condensation of air humidity on the appliance) may occur if a cold appliance is taken to a considerably warmer environment. In this case, acclimatize the disconnected appliance for ca. 2 hours at room temperature.
- Do not use suspended balance in environments exposed to corrosion hazards.
- Protect the suspended balance against high humidity, vapours and dust.
- Major display deviations (incorrect weighing results) may be experienced should electromagnetic fields (e.g. due to mobile phones or radio equipment), static electricity accumulations or instable power supply occur. Change location or remove source of interference.

## 2.4 Pay attention to the instructions in the Operation Manual



⇒ Carefully read this operation manual before setup and commissioning, even if you are already familiar with KERN balances.

## 2.5 Proper use

The balance you purchased is intended to determine the weighing value of material to be weighed. It is intended to be used as a “non-automatic” balance, i.e. the material to be weighed is suspended on the load receptor only vertically, manually, carefully and without jerks. As soon as a stable weighing value is reached the weighing value can be read.

- Use the suspended balance only for lifting and weighing of freely movable loads.
- Danger of injury due to improper use. Not allowed are e.g.:
  - Exceeding the allowed nominal load of crane, suspended balance or any type of load attachment devices
  - Conveying persons,
  - Pulling loads over an inclined surface,
  - Tearing-off, pulling or towing loads.
- Modifications or reconstructions of the suspended balance are not allowed.

## 2.6 Improper Use

Do not use balance for dynamic weighing. In the event that small quantities are removed or added to the material to be weighed, incorrect weighing results can be displayed due to the “stability compensation”. (Example: Slowly draining fluids from a container suspended on the balance.) Do not leave permanent load suspended on the balance. This may damage the measuring system as well as safety-relevant parts.

- ⇒ Make sure that never persons or objects are under the load which could be injured or damaged!
- ⇒ The balance is not suitable for weighing persons!
- ⇒ The balance does not correspond to the law of medical products (MPG).

The balance may only be used according to the described conditions. Other areas of use must be released by KERN in writing.

## 2.7 Warranty

Warranty claims shall be voided in case

- Our conditions in the operation manual are ignored
- The appliance is used outside the described uses
- The appliance is modified or opened
- Mechanical damage and damage caused by media, liquids,
- Natural wear and tear
- The appliance is improperly set up or incorrectly electrically connected
- The measuring system is overloaded

## **2.8 Safe working**

- Do not stand under swinging loads, see chap. 5.1.

## **2.9 Monitoring of Test Resources**

In the framework of quality assurance the measuring-related properties of the balance and, if applicable, the testing weight, must be checked regularly. The responsible user must define a suitable interval as well as type and scope of this test. Information is available on KERN's home page ([www.kern-sohn.com](http://www.kern-sohn.com)) with regard to the monitoring of balance test substances and the test weights required for this. In KERN's accredited DKD calibration laboratory test weights and balances may be calibrated (return to the national standard) fast and at moderate cost.

## **2.10 Testing upon acceptance**

Inspect packaging immediately upon receipt and inspect device when unpacking, see chap. 4.1. in the event of any evident damage.

## **2.11 Initial Commissioning**

In order to obtain exact results with the electronic balances, your balance must have reached the operating temperature (see warming up time chap. 1).

During this warming up time the balance must be connected to the power supply (mains, accumulator or battery).

The accuracy of the balance depends on the local acceleration of gravity.

Strictly observe hints in chapter Adjustment.

For checking original dimensions, s. chap. 4.3

## **2.12 Shutdown and storage**

- Switch off suspended balance and remove batteries
- Do not store suspended balance outdoors.

### 3. The suspended balance at a glance

#### 3.1 Overview

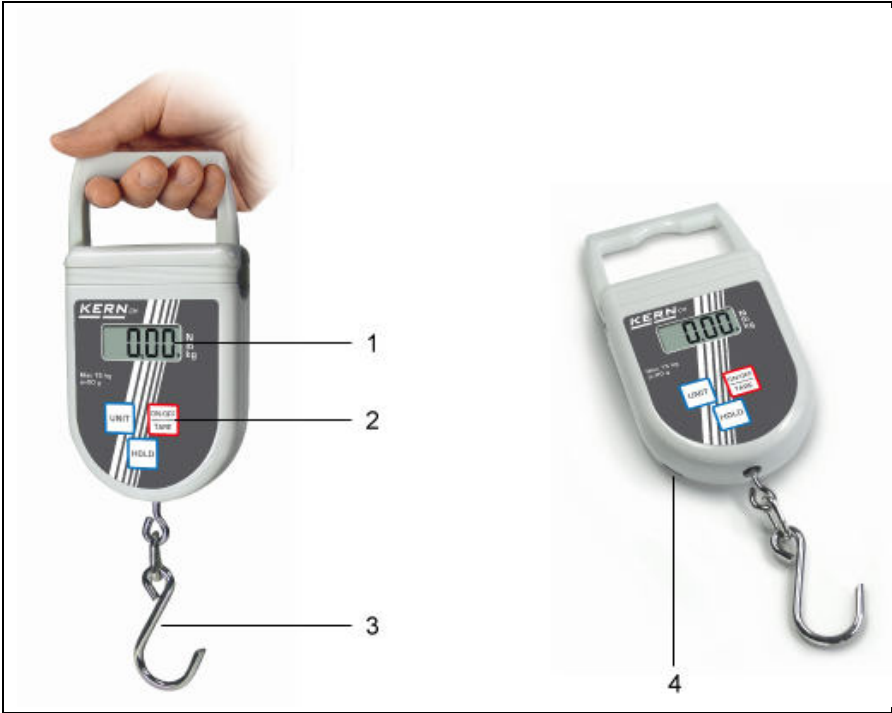

- 1 Display
- 2 Keyboard
- 3 Hooks
- 4 Tape measure



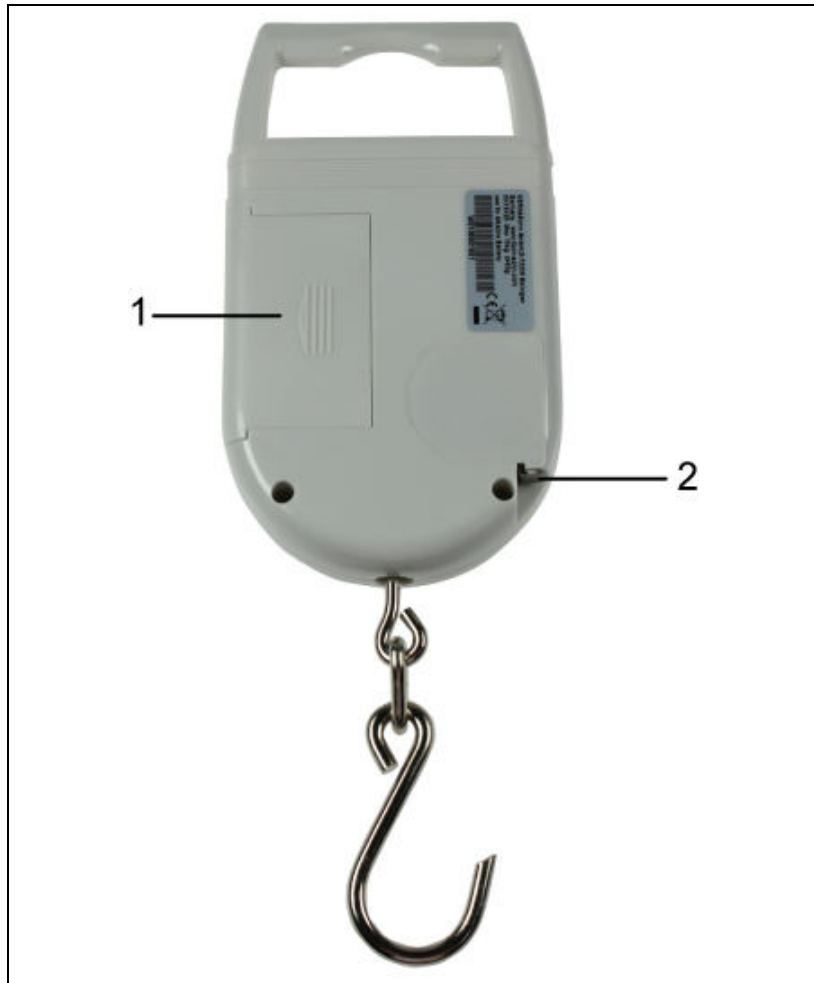

- 1 Battery compartment
- 2 Tape measure

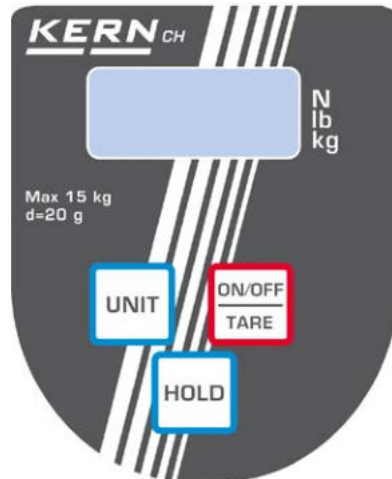

### 3.2 Overview visual displays and keyboard



#### Displays:

▶ <b>kg</b>	The current measuring unit is kilogram	
▶ <b>lb</b>	The current measuring unit is pound	
▶ <b>N</b>	The current measuring unit is Newton	
▲	Indicates the weight value depending on the active setting H1-H6 (see chap. 5.7).	
	H1-H4:	Data-Hold function
	H5	Animal weighing function
	H6	Peak value function
<b>LO</b>	Capacity of batteries exhausted	
<b>E</b>	Overload	

#### Keyboard:

Key	Description	Description of function
	<b>ON/OFF</b> button	<ul style="list-style-type: none"> <li>• Switch on balance</li> <li>• Switch off balance (hold button)</li> <li>• Taring</li> <li>• Scroll forward in menu</li> </ul>
	<b>UNIT</b> -button	Switch over weighing unit (kg→lb→N)
	<b>HOLD</b> button	<ul style="list-style-type: none"> <li>• Set weight display</li> <li>• Display average value for animal weighing</li> <li>• Confirm menu setting</li> </ul>

### 3.3 Label



- ⇒ Do not stand or go under suspended loads.
- ⇒ Do not use on building site.
- ⇒ Keep an eye on suspended loads.



- ⇒ Do not exceed nominal rated load of balance.

(example)





- ⇒ The product conforms to the requirements of the German Equipment and Product Safety Act.

## 4. Commissioning

	<b>+</b> Always observe chapter 2 „General Safety Instructions“!
---	--

### 4.1 Unpacking

 <b>SAFETY INSTRUCTIONS</b> for protection against break	<b>Once delivered and unpacked, suspended balance will not be taken back.</b>
	The suspended balance is sealed by KERN. ⇒ Removal from packaging is also sealed. <b>+</b> Broken seal obliges to purchase.  Fig.: Seal
	Thanks for your comprehension. Your KERN Quality assurance team

### 4.2 Scope of delivery

Remove balance and accessories from packaging, remove packaging material. Verify that there has been no damage and that all packing items are present.

- Suspended balance, see chap. 3.0
- Hook (stainless steel)
- Batteries (1 x 9 V block)
- Operating instructions / logbook

### 4.3 Checking the original dimensions

- ⇒ Enter the original dimensions shown on the production data sheet in the grey boxes of checklist chap. 8.3.
- ⇒ Check original dimension of suspended balance; for implementation see chap. 8.3 „Regular Maintenance“
- ⇒ Enter all data (date, tester, results) in the first line under „Inspection before first use“ in the checklist (see chapter 8.3)

 <b>CAUTION</b>	If the dimensions of your first safety inspection do not match those of KERN, the balance must not be put into operation. In this case please contact a service partner authorised by Messrs. KERN.
---	---

### 4.4 Battery operation



Push out battery cover on the rear side of the balance in arrow direction. Insert V block battery. Reinsert the battery cover. If the batteries are empty, in the balance display appears “LO”. Press **ON/OFF/TARE** -key and replace the batteries immediately. In order to save the battery, the balance switches automatically off after 4 minutes without weighing. This auto-off function can be deactivated in the menu (see chap. 6).

# 5. Operation



	<p>Keep balance only by hand, see fig. (do not use a crane or alike).</p>
--	---

## 5.1 Safety instructions

	<p><b>Risk of injury due to falling loads!</b> <b>DANGER</b></p>
--	--



(example)

- ⇒ Take great care when operating the crane and follow the general rules for crane operation.
- ⇒ Check all parts (hook, carabines, rings, rope slings, cables, chains etc.) for excessive wear or damage
- ⇒ Work only with appropriate speed
- ⇒ Always avoid vibrations and horizontal forces. Avoid any kind of shock, torsion and oscillating (e.g. caused by inclined suspending)
- ⇒ Do not use the suspended balance for conveying loads.
  
- ⇒ Do not stand or go under suspended loads.
  
- ⇒ Do not use on building site.
  
- ⇒ Keep an eye on suspended loads.
  
- ⇒ Do not exceed nominal rated load of suspended balance or any kind of attachment device on the suspended balance.

## **5.2 Loading the suspended balance**

For good weighing results observe the following, illustrations see next page:

- ⇒ Do not suspend the balance on load attachment devices. Use only when keeping by hand.
- ⇒ Do not pull or push the load or the loaded balance.
- ⇒ Do not pull the hook horizontally.

### **Loading the balance**

1. Position the hook of the suspended balance over the load.
2. Suspend and lift the load. (directly on the hook)





**Keep balance only by hand!**



**Do not push or pull**

**Do not pull the hook horizontally**

### 5.3 Turn on/off

#### Start-up

- ⇒ Press the **ON/OFF/TARE**-key. The display lights up and the balance carries out a selftest. The selftest is completed when the weight value 0.0 appears on the display.

#### Switching Off

- ⇒ Press the **ON/OFF/TARE**-key for a long time.

### 5.4 Taring

- ⇒ Suspend preload.  
Press the **ON/OFF/TARE**-button, the zero display appears. The weight of the container is now internally saved.



- ⇒ Weigh the material, the net weight will be indicated.
- ⇒ After removing the preload weight appears as negative display.
- ⇒ To delete the tare value, remove load from the suspended balance and press the **TARE** button.

### 5.5 Weighing

- ⇒ Load the suspended balance.  
The weight value will be displayed at once.



#### Overload warning

Overloading exceeding the stated maximum load (max) of the balance, minus a possibly existing tare load, must be strictly avoided. This could cause damage to the balance.

Exceeding the maximum load is indicated by the display „E“. Unload balance or reduce preload.

## 5.6 Switch-over weighing unit

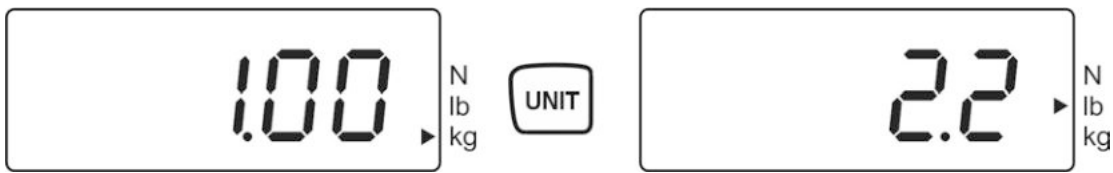

The next measuring unit will be displayed **kg**→**lb**→**N** after each press of the **UNIT** button.

The ► indicator shows the active unit.

## 5.7 Functions

With help of the **Hold**-key the following functions can be activated:

Adjustment	Function	
H1	Data-Hold function 1 Weighing value frozen for 5 sec. after pressing the <b>Hold</b> -key	+ see chap. 5.7.1
H2	Data-Hold function 2 The weighing value will be frozen after pressing the <b>Hold</b> -key until another key is actuated	
H3	Data-Hold function 3 The weighing value is automatically frozen for 5 sec.	
H4	Data-Hold function 4 The weighing value is automatically frozen after reaching a stable value until a key will be actuated	
H5	Animal weighing function	+ see chap. 5.7.2
H6	Peak value function	+ see chap. 5.7.3

### 5.7.1 Data-Hold function

- ⇒ Switch on the balance, keep the **HOLD**-button pressed until the current setting „Hx“ (H1 – H6) appears.
- ⇒ Press **ON/OFF/TARE**-button repeatedly until the desired setting „H1-H4“ is displayed.
- ⇒ Confirm setting with the **HOLD** button.
- ⇒ Suspend the material to be weighed
- ⇒ The weight value is fixed and displayed depending on the setting (H1 – H4) (see chap. 5.7), represented by the [▲] in the upper left.

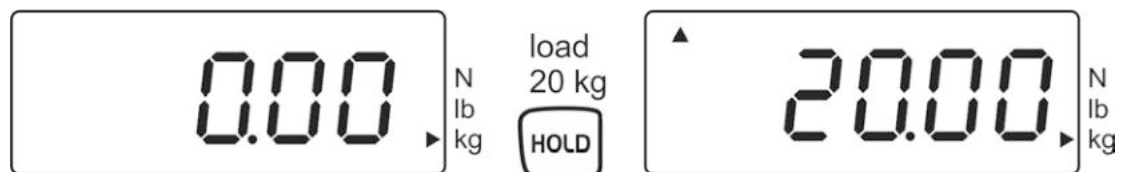

### 5.7.2 Animal weighing function

This function is suitable for busy weighing procedures. The result is a mean value formed by 16 weighing values.

- ⇒ Switch on balance using the **ON/OFF/TARE**-button
- ⇒ Press the **HOLD**-button and keep it pressed until „H x“ in the display appears
- ⇒ Press the **ON/OFF/TARE**-button until „H5“ in the display appears.
- ⇒ Save the setting by shortly pressing the **HOLD**-button
- ⇒ Press the **HOLD**-button anew
- ⇒ Upside left in the display a [▲] starts flashing.
- ⇒ Suspend a load
- ⇒ As long as the [▲] flashes, the weighing values are recorded.
- ⇒ After that the average weighing value of the recorded weighing values is recorded.

### 5.7.3 Peak value function

This function displays the highest load value (peak value) of a weighing.  
Measuring frequency: 200ms

#### Attention:



**Never exceed the maximum permitted load of the peak value on the balance (!!Danger of breaking!!).**

- Switch on balance using the **ON/OFF/TARE**-button
- Press the **HOLD**-button and keep it pressed until „H x“ in the display appears
- Press the **ON/OFF/TARE** until „H6“ in the display appears
- Save the setting by shortly pressing the **HOLD**-button
- Suspend a load
- The peak value function is displayed by a [▲] upside left

A negative value [-] is displayed as soon as the balance is relieved

## 6. Menu

- ⇒ When the balance is switched off, press the **HOLD**-key and keep it pressed
- ⇒ Do not release the **HOLD**-key. Press also the **ON/OFF/TARE**-key and keep it pressed
- ⇒ Keep the **ON/OFF/TARE**-key pressed, however release the **HOLD**-key
- ⇒ Press **HOLD**-key anew
- ⇒ Keep both keys pressed until in the display “tr” appears
- ⇒ Release both keys. The balance is situated in the menu.
- ⇒ Using the **ON/OFF/TARE** button you can select between the following functions:
  - **tr** (Zero tracking): **ON/OFF**
  - **AF** (Auto off): **ON/OFF**
  - **rST** (reset to factory settings): **YES/NO**
- ⇒ Press the **HOLD** button to confirm the selected function
- ⇒ In the display appears the current setting „**ON**“ or „**OFF**“ resp. „**YES**“ or „**NO**“. You can select between „**ON**“ or „**OFF**“ and/or „**YES**“ or „**NO**“ with the **ON/OFF/TARE**-button. Confirm your selection with the **HOLD**-key. After a short period the balance returns automatically to weighing mode.

## 7. Adjustment

As the acceleration value due to gravity is not the same at every location on earth, each balance must be coordinated - in compliance with the underlying physical weighing principle - to the existing acceleration due to gravity at its place of location (only if the balance has not already been adjusted to the location in the factory). This adjustment process must be carried out for the first commissioning, after each change of location as well as in case of fluctuating environment temperature. To receive accurate measuring values it is also recommended to adjust the balance periodically in weighing operation.

Observe stable environmental conditions. A warming up time of approx. 1 minute is recommended for stabilization.

Prepare adjustment weight, for details see chap. 1 „Technical data“.

⇒ Switch on balance



⇒ Press **Unit** button and hold down (approx. 3 sec) until „CAL“ is displayed.



⇒ Wait until the weight value of the required adjustment weight (e.g. 10 kg, see chap. 1) is displayed.



⇒ Attach adjustment weight, a short time later „F“ will appear.



⇒ After adjustment the balance automatically returns to weighing mode.  
An adjusting error or incorrect adjusting weight will be indicated by the error message; repeat adjustment procedure

## 8. Cleaning, Maintenance and Disposal

 <p><b>Danger</b></p>	<p><b>Risk of injury and risk of material damage!</b> <b>The suspended balance is part of the lifting gear!</b> <b>For a safe operation please observe the following:</b></p> <ul style="list-style-type: none"><li>⇒ Have carried out a regular maintenance by trained specialized staff</li><li>⇒ Carry out regular maintenance and servicing, see chap. 8.3.</li><li>⇒ Have the parts exchanged only by trained specialized staff.</li><li>⇒ If there arose discrepancies with the safety checklist, the balance must not more be put into operation.</li><li>⇒ Do not repair the suspended balance yourself. Repair may only be carried out by service partners authorized by Messrs. KERN.</li></ul>
--	---

### 8.1 Cleaning and Disposal

 <p><b>CAUTION</b></p>	<p><b>Damage to suspended balance!</b></p> <ul style="list-style-type: none"><li>⇒ Do not use industrial solutions or chemicals (e.g. acid → embrittlement).</li></ul>
--	--

- ⇒ Clean the keyboard and the display with a soft cloth soaked in mild window cleaning agent.
- ⇒ Disposal of packaging and appliance must be carried out by operator according to valid national or regional law of the location where the appliance is used.

## **8.2 Regular maintenance and care**

- ▲ The regular 3-month maintenance may only be carried out by an expert with competent knowledge of working with suspended balances. Thereby the national regulations for prevention of accidents as well as the working, operation and safety regulations of the owner-operator.
- ▲ To check the dimensions only use suitable test devices.
- ▲ The regular 12-month maintenance must only be carried out by trained specialized staff (KERN customer service).
- ▲ The results of the maintenance must be written down in the checklist (chap. 8.3).
- ▲ The additional results of the extended maintenance have to be entered in the checklist (chapter 9.1).
- ▲ The load suspension device is to be cleaned before inspection, see chap. 8.1.



## Regular maintenance:

<b>Prior to each usage</b>	<ul style="list-style-type: none"><li>▪ Check for fault-free operation of the attachment devices</li></ul>
<b>Initial start-up, every 3 months or definitely after 12 500 weighing processes</b>	<ul style="list-style-type: none"><li>▪ Check all dimensions, see checklist chap. 8.3</li><li>▪ Check the attachment device (handle grip) for wear and tear, such as e.g. plastic deformation, mechanical damage (unevenness), notches, striation, cracks, corrosion, thread damage and torsions.</li><li>▪ Remove balance from use immediately if a reading exceeds the permitted deviation from the original reading (see checklist, chap. 8.3) or any other fault is identified.</li><li>▪ All repairs and replacement parts (e.g. hook) must be documented by the service partner (see list, chap. 9.1).</li></ul>
<b>Every 12 months or in any case after 50 000 weighings</b>	<ul style="list-style-type: none"><li>▪ If the enhanced maintenance has to be carried out by trained staff (KERN customer service). At this general revision all load carrying parts must be checked for gaps with magnetic powder</li><li>▪ Plastic parts such as handle must be visually inspected</li></ul>
<b>Every 10 years or anyway after 500 000 weighings</b>	<ul style="list-style-type: none"><li>▪ Replace the crane balance entirely</li></ul>

### Note

During the revision watch out for wear and tear according to the following drawings (chap. 8.3).

**Rejection criteria:** Load suspension devices may no longer be used when e.g.

- + Deviations are identified during the inspections specified for servicing.
- + The type or load rating plate is missing.
- + Load suspension devices known to have been overloaded or subject to other harmful influences may no longer be used and/or may be re-used only after inspection.

### 8.3 Checklist „Regular maintenance“

Original dimensions suspended balance*, serial no.: ..... Capacity .....								
<b>Total scale</b>		<b>Hooks</b>						
d (mm)	e (mm)	f (mm)	g (mm)	h (mm)	i (mm)	Wear and tear	Angle $\alpha$ (°)	
<b>Date</b> .....		<b>Tester</b> .....						

\*These data can be found in the document attached to the balance. Please keep this document always available.

	Total scale	Hooks							Optical test				Date	Tester
	d	e	f	g	h	i	$\alpha$	Wear (see cross-hatched areas)	No deformation, wear or cracks					
									handle	hook	chain link	other parts		
Max. admitted variation	1%	1%	5%	5%	5%	5%	10°							
Revision prior to first use														
3 months/12 500 x														
6 months/25 000 x														
9 months/37 500 x														
<b>12 months/50 000 x</b>														
15 months/62 500 x														
18 months/75 000 x														
21 months/87 500 x														

	Total scale		Hooks							Optical test				Date	Tester
	d	Safety fastening	e	f	g	h	i	α	Wear (see cross-hatched areas)	No deformation, wear or cracks					
										handle	hook	chain link	other parts		
Max. admitted variation	1%	Perfect working order	1%	5 %	5 %	5 %	5 %	10 °							
Revision prior to first use															
<b>24 months/100 000 x</b>															
27 months/112,500 x															
30 months/125 000 x															
33 months/137 500 x															
<b>36 months/150 000 x</b>															
39 months/162 500 x															
21 months/87 500 x															
42 months/175 000 x															
45 months/187 500 x															
<b>48 months/200 000</b>															
51 months/212 500 x															
54 months/225 000 x															
57 months/237 500 x															
<b>60 months/250 000x</b>	➔ All load carrying parts have to be exchanged by a service partner authorised by KERN.														

**bold letters** = this maintenance work has to be carried out by a service partner authorized by KERN.

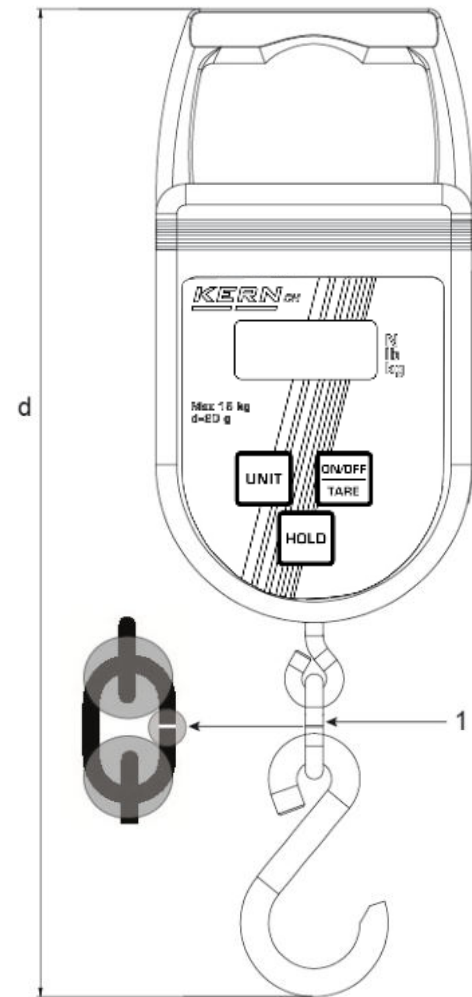
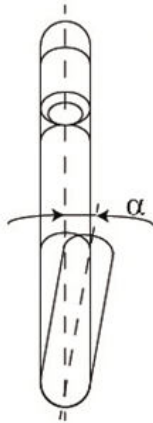
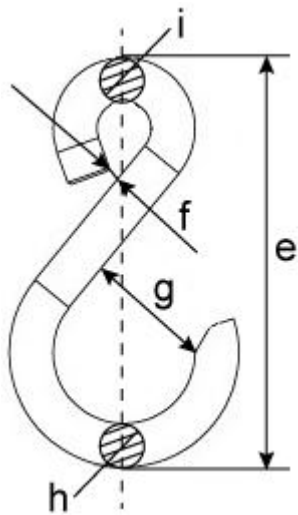

1 Chain link

## 9. Enclosure

### 9.1 Checklist „Enhanced maintenance“ (General revision)

The enhanced maintenance has to be carried out by a service partner authorized by KERN.

Suspending balance		Model ..... Serial no. ....					
Interval	Magnetic powder test for cracks	Hooks	Chain links (marked areas)	Hand grip	Date	Name	Signature
12 months/50 000 x							
24 months/100 000 x							
36 months/150 000 x							
48 months/200 000 x							
60 months/250 000 x							
72 months/300 000 x							
84 months/350 000 x							
96 months/400 000 x							
108 months/450 000 x							
120 months/500 000x	➔ Replace suspended balance completely						

