











# PPS 1100 / 1200

Portable High Pressure Calibrator



## List of Contents

Contents	Chapter	Symbol
General	1	
Safety Instructions	2	
Technical Data	3	
Functions	4	
Transport/Scope of Supply	5	
Mounting	6	
Commissioning	7	
Operation	8	
Maintenance	9	
Accessories	10	
Fault Finding	11	
Declaration of Conformity	12	



## 1. General

1.1	Notices	3
1.3	Copyright	4
1.3	Explanation of Symbols	
1.4	Abbreviations	5
1.5	Intended Use	5
1.6	Obligation of the Operator	5

### 1.1 Notices

This operating manual applies only to the portable High Pressure Calibrators PPS 1100 and PPS 1200. It must always be available and accessible in the vicinity of the High Pressure Calibrators.

The contents of this operating manual must be completely read, understood and observed by each responsible staff member. In particular, this applies to the safety instructions. Observing the safety instructions will help to avoid accidents, malfunctions and faults.

**DYNISCO** does not assume liability for personal injury, material damage and the resulting losses of production due to disregard of the operating manual.

If malfunctions occur although the operating manual has been observed please contact the **DYNISCO** after-sales service (see Chapter 9 Maintenance).

In particular, this applies during the period of guarantee.

### 1.2 Copyright

For copyright reasons this operating manual may only be used for inhouse purposes.



Any reproduction, even in part and for inhouse purposes, requires the assent by Messrs **DYNISCO**. Also, any distribution to third parties is prohibited for competitive reasons.

### 1.3 Explanation of Symbols

In the operating manual safety instructions are indicated by means of pictorial symbols:

**ATTENTION**

Hazard of damaging or destroying equipment, machinery, or installation.



General hazard to life and limb.



Specific hazard to life and limb.

In the operating manual the safety instructions are also given specifically for each chapter.



#### 1.4 Abbreviations

The following abbreviations are used:

**OM** operating manual  
**HPC** high pressure calibrator  
**FS** of full scale

#### 1.5 Intended Use

The portable High Pressure Calibrators PPS 1100 and PPS 1200 are specifically intended for the calibration and testing of pressure transmitters. For this purpose the pressure generated by the High Pressure Calibrator and the output voltage of the test unit are measured and displayed.

It is prohibited to use the High Pressure Calibrator for other purposes.

#### 1.6 Obligation of the Operator

The operator is responsible for the observance of the safety and accident prevention regulations valid for the special field of application.



## 2. Safety Instructions



The operator is responsible for the observance of the safety and accident prevention regulations valid for the special field of application.



The High Pressure Calibrator may only be used by trained personnel and in accordance with the valid laws and regulations.



Mounting, electrical connection and pressure connection of test units may only be carried out by trained personnel and in accordance with the valid laws and regulations, the equipment being **free from electricity, depressurized and switched off.**



### **Hazard of injury!**

Inside the High Pressure Calibrator pressures up to 700 bar might occur.  
Do not open shut-off valve when under high pressure.



### **Explosion hazard!**

Batteries must not be thrown into the fire, heated above 100°C or recharged.



### **Hazard of intoxication!**

Do not open batteries. In case their contents have been swallowed see a doctor immediately.



### **Burning hazard!**

The temperature of the heatable pressure port may be up to 400°C.

**Wear protective gloves!**



### 3. Technical Data

3.1	Order Specifications	7
3.2	Example of an Order	7
3.3	High Pressure Calibrator PPS 1100	8
3.4	High Pressure Calibrator PPS 1200	8

#### 3.1 Order Specifications

PPS 1X00 - XX - X - X

**Operating voltage** (only for PPS 1200)

- 0 115 V AC
- 3 230 V AC

**Options**

- 0 none

**Pressure range**

- 2C 0 - 200 bar
- 3C 0 - 350 bar
- 7C 0 - 700 bar

**Version**

- 1 Standard version
- 2 Similar to PPS 1100  
plus additional features:
  - testing electronic pressure switches
  - checking transmitter linearity
  - heatable pressure port

#### 3.2 Example of an Order

**PPS 1100 - 7C - 0**      Portable High Pressure Calibrator,  
standard version,  
pressure range 0 - 700 bar



### 3.3 High Pressure Calibrator PPS 1100

Pressure range:	0 - 700 bar (depending on the model)
Overpressure:	FS + 20 %
Resolution of display:	100 mbar
Accuracy:	± 0,1 % FS (with t = 0 °C, up to 50°C)
Measurement cycle:	500 ms (2 Hz)
Memory:	900 storage places (8,000 optional)
Selectable pressure units:	bar / PSI / kPA / mWC
Pressure port:	1/2" 20UNF (other ports on request)
Media compatibility:	Pressure transducer with stainless steel diaphragm. Electronics sealed with gel.
Oil chamber volume:	57 ml
Oil type:	Olive oil
Voltage supply:	Lithium battery 3.6 V (not rechargeable)
Battery life:	> 200 days with continuous operation
Transmitter power supply:	2 x 9 V batteries (not rechargeable)
Protection:	IP 65
Storage temperature:	-20 °C ... +60 °C
Operating temperature:	0 °C ... +50 °C
Compensated temperature range:	0 °C ... +50 °C
Humidity:	5 ... 95 % relative humidity, not condensing
Dimensions (LxWxH):	337 x 153 x 205 mm
Weight:	approx. 3.9 kg (incl. batteries)

### 3.4 High Pressure Calibrator PPS 1200

Similar to PPS 1100. Exceptions / additional:

Heatable pressure port:	up to 400 °C, PID controlled
Dimensions (LxWxH):	440 x 153 x 300 mm
Weight:	approx. 8 kg (incl. batteries)
Temperature display:	temperature of reference sensor in °C
Voltage supply of temperature controller and pressure port:	115 V AC or 230 V AC





## 4. Functions

4.1	Function Description	9
4.2	Display and Operating Elements	10
4.3	Components	10
4.4	Modes of Operation	12

### 4.1 Function Description

The portable High Pressure Calibrators PPS 1100 and PPS 1200 are used to calibrate and test pressure transmitters quickly and accurately. The instrument is battery powered and thus very well suited for outdoor use. The calibrator itself is powered by a 3.6-V lithium battery. Test-units can be powered by an external power supply.

The transmitter which is to be tested is screwed into the test unit adapter of the calibrator. The calibrator generates pressure by means of both the integrated priming pump and the oil screw compressor. The pressure can be fine adjusted.

The high-end technology integrated in this instrument allows to measure precisely both the pressure generated and the output signal of a test-unit connected.

Thus test-units can be measured and their characteristics can exactly be documented.

The standard calibrator has an internal memory for recording data. It can either be filled with the linearity measurements (Lin function)\*, the switching points of a pressure switch (Pst function)\* or with continuously measured recordings (Rec function).

This data can later be transferred to a PC for evaluation.

\* PPS 1200 only



## 4.2 Display and Operating Elements

### 4.2.1 High Pressure Calibrator PPS 1100

The measured values are shown on the integrated digital display (4).  
The calibrator is mainly operated via the **function key (F key)** (5), marked by a triangle below the display.  
An additional key, the **Hold key** (2), will freeze the display at any time during operation.

### 4.2.1 High Pressure Calibrator PPS 1200

Similar to PPS 1100 plus additional features:

Desired value of the pressure port temperature entered via the keys ▲ and ▼ on the temperature controller (14). Actual pressure port temperature shown on the display of the temperature controller (14).

## 4.3 Components

### 4.3.1 Components of High Pressure Calibrator PPS 1100 / 1200

- 1 Connector, standard version (PC interface / RS232)
- 2 HOLD key (H key)
- 3 Shut-off valve
- 4 Display
- 5 Function key (F key)
- 6 Oil chamber
- 7 Oil refill screw
- 8 Oil screw compressor
- 9a Outlet pressure port (G 1/4") with screw plug  
(200-bar and 350-bar calibrator with pressure relief valve)
- 9b Outlet Pressure Port without pressure relief valve (700-bar calibrator)
- 10 Priming pump
- 11 Return pipe

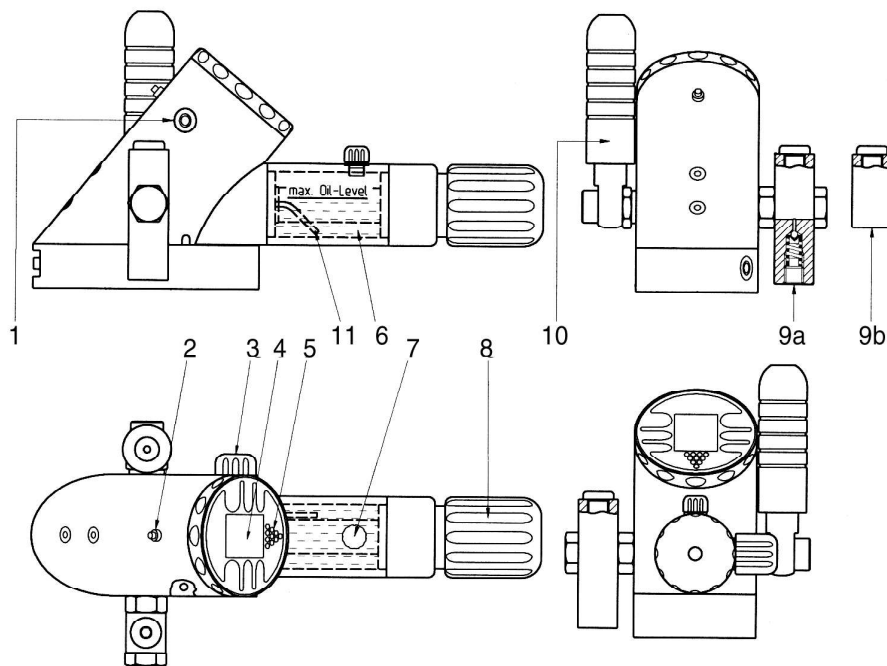

Fig. 01: Components of High Pressure Calibrator PPS 1100



#### 4.3.2 Additional components of High Pressure Calibrator PPS 1200

Similar to PPS 1100 plus the following:

- 12 Heatable pressure port
- 13 Pressure pipe
- 14 Temperature controller
- 15 On / Off switch for pressure port heating
- 16 Temperature controller casing
- 17 Electrical connector for test unit adapter
- 18 Power line plug

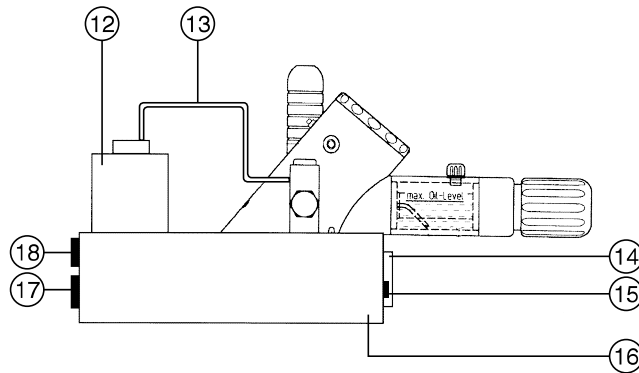

Fig. 02: Additional Components of High Pressure Calibrator PPS 1200

#### 4.4 Modes of Operation

When keeping the **F key** depressed, the functions **EXE, OFF, MANO, TARA, UNIT, LEAK, PST \*, REC, LIN \*, ZERO, RES** and ascending numbers will appear successively on the display. Releasing the F key at one of the displayed functions activates and leads into the function. This cycle (constantly pressing the F key and letting go the key at a desired function) will be called activation in the following (e.g. in order to activate **MANO**: Press **F key** until display shows **MANO** --> Release **F key**).

Within specific functions, the **F key** can carry out additional commands (**EXE, STEP, RESET**).

Activating **Off** turns off the instrument. When starting the instrument again, the display will automatically lead into the function from which the instrument was previously turned off.

<b>EXE:</b>	In the <b>MANO</b> mode: To reset the peak and trough pressures.
<b>OFF:</b>	To turn off the instrument.
<b>MANO:</b>	To display the actual pressure generated, the unit as well as the peak and trough pressures.
<b>TARA:</b>	To set a new, <i>volatile</i> zero reference (Tare).
<b>UNIT:</b>	To display the pressure in different units (bar, PSI, kPA, mWC...).
<b>LEAK:</b>	To measure the pressure changes over a programmable time.
<b>PST *:</b>	To test pressure switches.
<b>REC:</b>	To record the measured values in programmable intervals.
<b>LIN *:</b>	To determine the linearity of a test-unit.
<b>RES:</b>	To reduce or increase the resolution by a factor of 10.
<b>ZERO:</b>	To write a new zero reference into the <i>non-volatile</i> memory.
<b>28, 29...</b>	Ascending numbers (no function).

\* PPS 1200 only



## 5. Transport/Scope of Supply

5.1	Transport/Packaging/Shipping damage	14
5.2	Storage	14
5.3	Scope of Supply	14

**ATTENTION** The storing temperature must not fall below -20°C or exceed +60°C.

### 5.1 Transport/Packaging/Shipping damage

- During transport make sure that the high pressure calibrator is not damaged by other objects.
- Use only original packaging.
- Immediately communicate any shipping damage to **DYNISCO** in writing.

### 5.2 Storage

- Store High Pressure Calibrator only in original packaging
- and protected from dust or humidity.

### 5.3 Scope of Supply

- High Pressure Calibrator
- Adapter for 4 ... 20 mA / 0 ... 20 mA transmitter \*
- Adapter for 0 ... 10 V / 0 ... 20 V transmitter \*
- Pressure switch adapter \*
- Pressure port 1/2" 20UNF
- Test certificate
- Spare lithium battery ER6C (AA) 3.5 V
- Allen wrench
- Carrying case (lockable)



## 6. Mounting

6.1	Connecting Test Units	15
6.2	Pressure Connection for the Test Unit	16
6.3	Electrical Connection of the Test Unit	16
6.4	External Power Supply of the Test Unit	16



Mounting, electrical connection and pressure connection of test units may only be carried out by trained personnel and in accordance with the valid laws and regulations, the equipment being **free from electricity, depressurized and switched off**.



### **Burning hazard!**

The temperature of the heatable pressure port may be up to 400°C.

**Wear protective gloves!**

### **ATTENTION**

Any deviation of the supply voltage from the value specified in the technical data or the wrong polarity might result in damages and malfunctions of the High Pressure Calibrator

### 6.1 Connecting Test Units\*

Included in the scope of supply of the calibrator are different test-unit adapters, one for each of the following transmitter types:

- 4 ... 20 mA / 0 ... 20 mA transmitter
- 0 ... 10 V / 0 ... 20 V transmitter
- Pressure switch
  
- Select the correct test unit adapter for the test unit in question.
- If already installed detach the test unit adapter from the pressure pipe and from connector 17.
- Clamp test unit adaptor in a vise at its two lower flats.

\* PPS 1200 only



- Screw test unit into the test unit adapter and tighten with the correct torque.
- Insert test unit adapter along with the test unit into the calibrator and make pressure connection.
- Connect test unit adapter to connector 17

#### **Transmitter Adapter \***

Internal power supply is ensured when the heating of the pressure port is turned on (switch 15).

Connect transmitter. The lower left display will show the initial state of the transmitter in mA or in V.

#### **Pressure Switch \***

Internal power supply is ensured when the heating of the pressure port is turned on (switch 15).

Connect pressure switch. The display will show the switch status of the pressure switch.

### **6.2 Pressure Connection for the Test Unit**

Your test-unit can be connected with the calibrator via the pressure connection 9a or 9b.

### **6.3 Electrical Connection of the Test Unit \***

Wire the test unit to the correct connectors of the test unit adapter. Ensure correct polarity and correct connection of the signal lines.

### **6.4 External Power Supply of the Test Unit \***

The test unit is powered externally via a power supply unit assembled inside the casing of the temperature controller (14). The external power supply is only activated as long as the pressure port heating is turned on.





## 7. Commissioning

7.1	Turn-On	17
7.2	Pressure Generation	17
7.3	Decreasing the Pressure	18
7.4	Turn-Off	18
7.5	Setting the Desired Temperature of the Heatable Pressure Port	18



### **Hazard of injury!**

Inside the High Pressure Calibrator pressures up to 700 bar might occur.

Do not open shut-off valve when under high pressure.



### **Burning hazard!**

The temperature of the heatable pressure port may be up to 400°C.

**Wear protective gloves!**

### **ATTENTION**

If the pressure exceeds the full scale value by more than 20% the internal sensor might be destroyed!

With the High Pressure Calibrator PPS 1200 having a pressure range of up to 350 bar oil might leak out of the pressure-relief valve.

### 7.1 Turn-On

The calibrator is turned on by briefly pressing the **F key** once.

### 7.2 Pressure Generation

Set the pressure to approx. 10 bar via the priming pump (10). Increase or reduce the pressure by means of the screw compressor (8).



### 7.3 Decreasing the Pressure



#### **Hazard of injury!**

Inside the High Pressure Calibrator pressures up to 700 bar might occur. Do not open shut-off valve when under high pressure.

- Completely screw back the screw compressor (8).
- Slowly open shut-off valve (3) and thus slowly reduce pressure.

If you are unable to reach the desired pressure see chapter 'Maintenance' for instructions on how to completely prime the system.

### 7.4 Turn-Off

Press the **F key** until the command **OFF** appears on the display. Release the key immediately and the instrument will turn off.

### 7.5 Setting the Desired Temperature of the Heatable Pressure Port \*



#### **Burning hazard!**

The temperature of the heatable pressure port may be up to 400°C.

#### **Wear protective gloves!**

- Keep key ▲ or ▼ on the temperature controller (14) depressed for more than 3 seconds.

The desired value begins to vary.

- Set desired temperature (0 ... 400 °C) by means of key ▲ or ▼.

▲ = will increase the desired value

▼ = will reduce the desired value



As soon as your desired value is reached stop pushing the keys. The new desired value will be entered automatically 3 seconds after the last key has been pushed. Then the instrument will return to the actual temperature display.

The actual temperature will be adjusted to the desired temperature.

### 7.5.1 Limiting the desired temperature

The desired temperature may be limited. In order to do so set the **SP.hi** parameter of the temperature controller to the desired peak value and confirm by pushing the FUNC key (for the parameterization of the temperature controller see separate operating instructions for Temperature Controller 1430).



## 8. Operation

8.1	MANO Mode	20
8.2	TARA Mode	23
8.3	UNIT Mode	24
8.4	LEAK Mode	25
8.5	PST Mode	28
8.6	REC Mode	31
8.7	LIN Mode	34
8.8	RES Mode	36
8.9	ZERO Mode	36
8.10	Data Transfer to PC	37



The operator is responsible for the observance of the safety and accident prevention regulations valid for the special field of application.



The High Pressure Calibrator may only be used by trained personnel and in accordance with the valid laws and regulations.



Mounting, electrical connection and pressure connection of test units may only be carried out by trained personnel and in accordance with the valid laws and regulations, the equipment being **free from electricity, depressurized** and **switched off**.



### **Hazard of injury!**

Inside the High Pressure Calibrator pressures up to 700 bar might occur.  
Do not open shut-off valve when under high pressure.



### **Burning hazard!**

The temperature of the heatable pressure port may be up to 400°C.

**Wear protective gloves!**



## 8.1 MANO Mode

The **MANO** mode is the standard mode of the calibrator. In this mode, the calibrator shows the actual pressure on the upper display. The smaller displays below indicate the peak and trough values. The measured values on the lower displays always appear with a reduced resolution. Activating **EXE** resets the peak and trough values, meaning that they are set to the actual pressure.

PPS 1200 only: If a transmitter is connected via the adapters the display automatically indicates the value of the transmitter in mA or V on the lower left display. The lower right display shows the temperature.

Pressing the **Hold key (H key)** freezes the measured values. The actual pressure is now shown on the lower right display. Pressing the H key again leads back into the **MANO** mode with the peak and trough values reset to the actual pressure (same as **EXE**).

### **ATTENTION**



Is read as a “1” between 100 bar and 200 bar when displaying with increased resolution.

Example:  corresponds to **133,41** bar



### MANO Mode

Display without transmitter

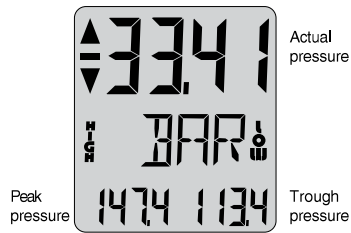

– Activate EXE

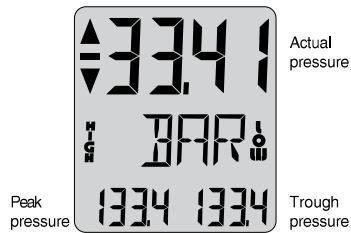

– Press Hold key

### HOLD Mode



– Press Hold key to return to MANO Mode

### MANO Mode

Display with transmitter \*



– Press Hold key

### HOLD Mode

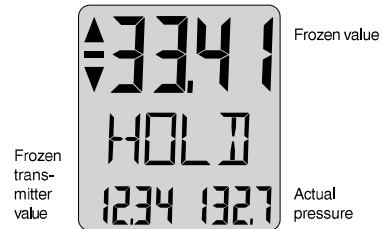



## 8.2 TARA Mode

The **TARA** Mode serves to set a temporary zero reference. Unlike to the **ZERO** Mode, this new zero reference will not be maintained after the instrument has been turned off.

The instrument then returns to the **MANO** Mode.

### Activate TARA



- Activate **EXE**

### MANO Mode

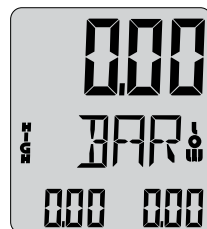

With the command **EXE** the new zero is determined and remains a reference until a new **TARA** is carried out or until the instrument is turned off.



### 8.3 UNIT Mode

The **UNIT** mode allows the selection of one of four pressure units.

#### Activate **UNIT**



- Activate **EXE**

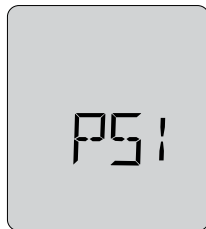

- Activate **EXE**



- Activate **EXE**

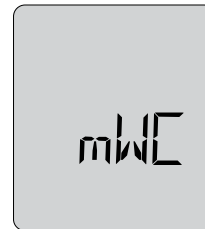

In order to return to the **MANO** mode with the new selected unit:

- Activate **MANO**.

Please note that, depending on the pressure range, the units might differ.





## 8.4 LEAK Mode

The **LEAK** mode is used to measure a change in pressure over a programmable time. The test unit has to be connected to the calibrator.

### Setting the Test Time Activate LEAK

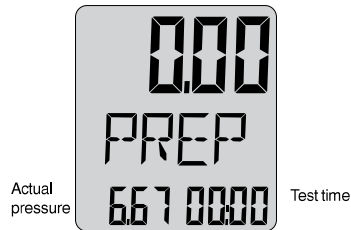

- Activate **SEL**

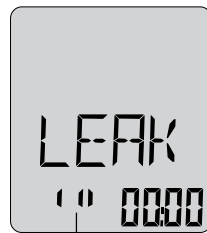

Flashing

- **EXE** switches to **hr** (hours)
- **EXE** again switches to **day**.

- Activate **STEP**



First digit is flashing.

- **EXE** ascends digit.
- **STEP** moves to next digit.
- Activate **STEP**

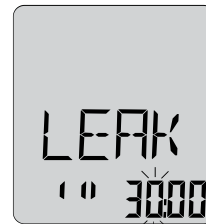

Second digit is flashing.

- **EXE** ascends digit.
- **STEP** moves to next digit.

etc.



When the test time is set, activate **PREP**. The display is now back in the **PREP** mode.



The test time is now programmed (35:00). The start of the **LEAK** test is described on the following page.



### 8.4.1 Starting the LEAK Test

After setting the test time the display is in the **PREP** Mode:

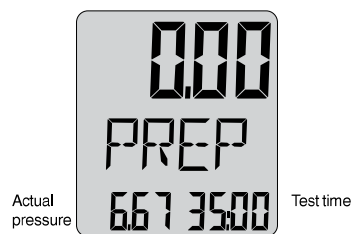

– Press **Hold key** or activate **RUN**

#### During Test

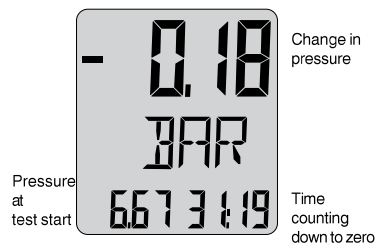

#### After Test

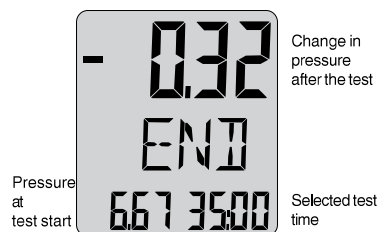

After the test the measured values are frozen. Activate **PREP** to return to the **PREP** Mode from the **END** display.

A new test may be started as follows (also when measurements are running):

- Press **Hold key** or
- activate **RUN** via **F key**

At any time you may return to the **MANO** mode by activating **MANO**. Activating **MANO** will interrupt a running **LEAK** test.



## 8.5 PST Mode \*

This mode allows to test mechanical and electronic pressure switches. The display always indicates the switch status and the switching pressure points of the test unit. The actual status (Open/Close) and the corresponding switching pressure are displayed with each change of status of the pressure switch.

The actual pressure is indicated on the top display.

All switching points are recorded and may be written into a PC and displayed on the screen at a later time (only with Logger option).

Activating **END** followed by the activation of any other function quits the **PST Mode** and leads into the new selected function.

### Activate PST

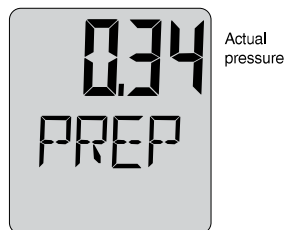

- Connect pressure switch

- Press **H key** or activate **RUN**.

The recording of the switching pressure points will start.

The pressure switch closes.  
The status and the switching pressure are displayed.



The pressure switch closes.  
The status and the switching  
pressure are displayed.

- Press **H** key.

The recording of the switching  
pressure points will end.



In the **STOP** mode a new switch  
may be connected without  
influencing status or recording.

- Press **H** key.



- New start of measurement,

#### **Back to MANO mode**

- Activate **END**

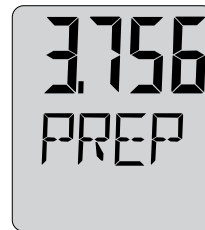

- Activate **MANO**



#### **Note on the PST Mode**

The test measurements can be started in each position of the connected pressure switch.

If the measurement is started at a high pressure and the pressure switch switches at a lower pressure the first switching point is automatically indicated on the small display on the right (Low).

Another increase in pressure from this status will cause the new switching point to be written automatically into the small display on the left (High). The pressure decreasing again results in the new switching point being written into the Low again, etc.

This allows various switching points to be registered for the same pressure switch. They are recorded in the memory in pairs.

Activate **RUN** in order to start a new measurement at any time.



## 8.6 REC Mode

In the **REC** (or Record) mode the measured values may be stored. The number of values to be stored and the interval (in minutes and seconds) are programmable.

Subsequently, one storage cycle comprising the programmed number of measurements will be called a **recording**.

### PPS 1200 only:

If no transmitter is connected only the actual pressure will be stored when recording. When recording with a transmitter connected, three values will be stored per recording:

Actual pressure, transmitter signal and temperature.

Please note that when storing three values per recording, the requirements on storage capacity will triple (1000 measurements with three values each lead to 3000 measured values in all).

## Adjustment of the Storage Parameters

### Activate REC

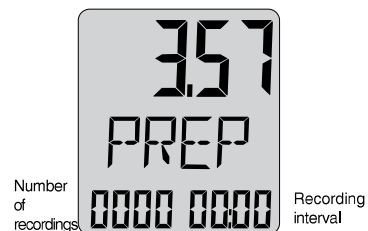

### – Activate SEL

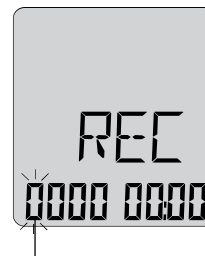

First digit is flashing.

- **EXE** ascends digit.
- **STEP** moves to next digit.



- Activate **STEP**

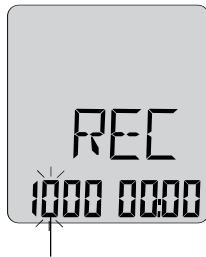

Second digit is flashing.

- **EXE** ascends digit.
- **STEP** moves to next digit.

etc.

The adjustment of the storage parameters can be terminated by activating **PREP**.

The display is now in the **PREP** mode again. The newly set storage parameters are shown in the display:

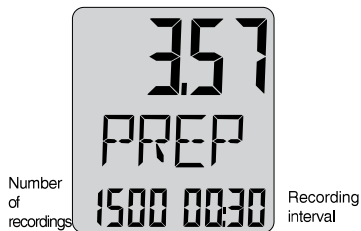

### Start of the Recordings

After the adjustment of the storage parameters, the display is in the **PREP** mode.

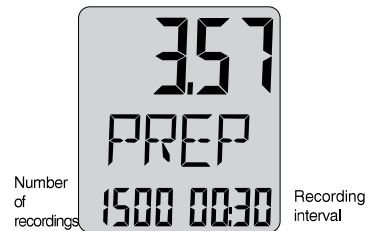

- Activate **RUN**

### During the Recording

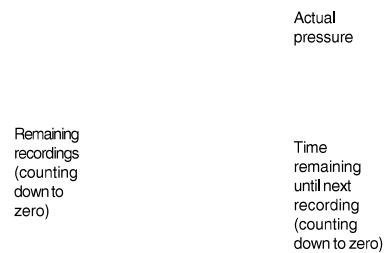





### After the Recording

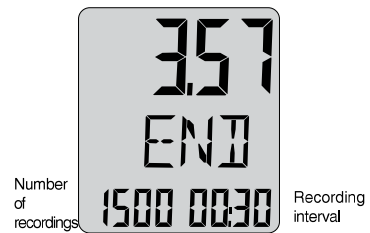

The display **END** indicates the end of the recording. Activate **PREP** to return to the **PREP** mode from the **END** display.

At any time, a recording can prematurely be terminated by activating **RES**.

In the **REC** mode you may also display the temperature.

Pressing the **H** key from a **PREP** display will indicate the temperature on the lower right display.

To quit the **REC** mode activate **PREP** and then select any function.



### 8.7 LIN Mode \*

The linearity mode allows for determination of the linearity error of a test unit.

The linearity is calculated as terminal linearity, i.e., the ideal line is drawn through the first and the last measuring points.

The linearity error is indicated as a percentage of the span between the first and the last measured values. A maximum of 10 linearity values are allowed.

After activating **LIN** the command **SAVE** writes the actual values of the reference pressure and of the test unit into the memory. This cycle can be quit by activating **SAVE**.

#### The Linearity Test

##### Activate LIN

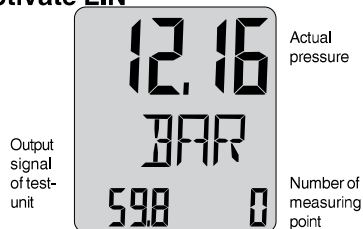

- Press **H key** or activate **SAVE**

Measured values are written into the memory



New number indicates: Measured value has been registered.

- Increase in pressure >>>
- Press **H key** or activate **SAVE**



Second measured value has been registered.



### Calculating the Linearity

After registration of the measuring points, the calculation of the linearity is initiated with the command **CALC**.

After the calculation, the pressure and measuring point with the highest linearity error are shown.

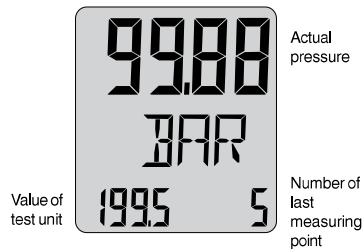

– Activate **CALC**

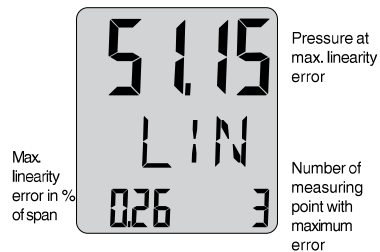

From this position the linearity of all other measuring points can be retrieved.

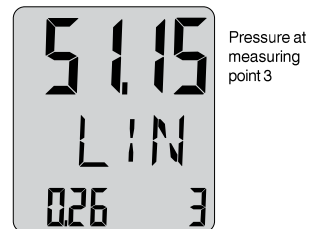

– Activate **EXE**

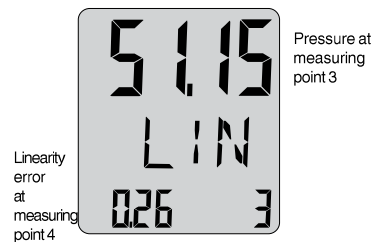

– Activate **EXE** to go to measuring points 5, 1, 2 ...

– Activate **PREP** for new linearity test.



### 8.8 RES Mode

The activation of **RES** reduces the resolution by a factor of 10 or resets the display to the initial resolution.



- Activate **RES**



- Activate **RES**

### 8.9 ZERO Mode

Changes in ambient pressure as well as position or temperature influences might result in zero shifts.

These shifts can be permanently corrected as follows.

- Activate **ZERO**

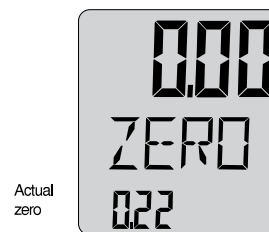

- Activate **EXE**

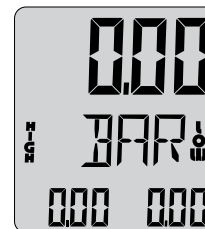

The new zero is set and permanently stored, i.e., this zero will be maintained when turning off the instrument.

The programme automatically returns to the **MANO** mode after setting the new zero.



## 8.10 Data Transfer to PC (Accessory)

In order to transfer the data from the calibrator to the PC the special cable K101 and special software are required. The data transfer is accomplished via a RS232 serial interface. The connector for the cable is integrated in the instrument.

### 8.10.1 Logger Software

This software is used to transfer the data to a PC, offering many further processing possibilities of the read-out data. The Logger software meets all the requirements on modern Windows software:

- graphical display
- tabulated display
- export to other Windows programs

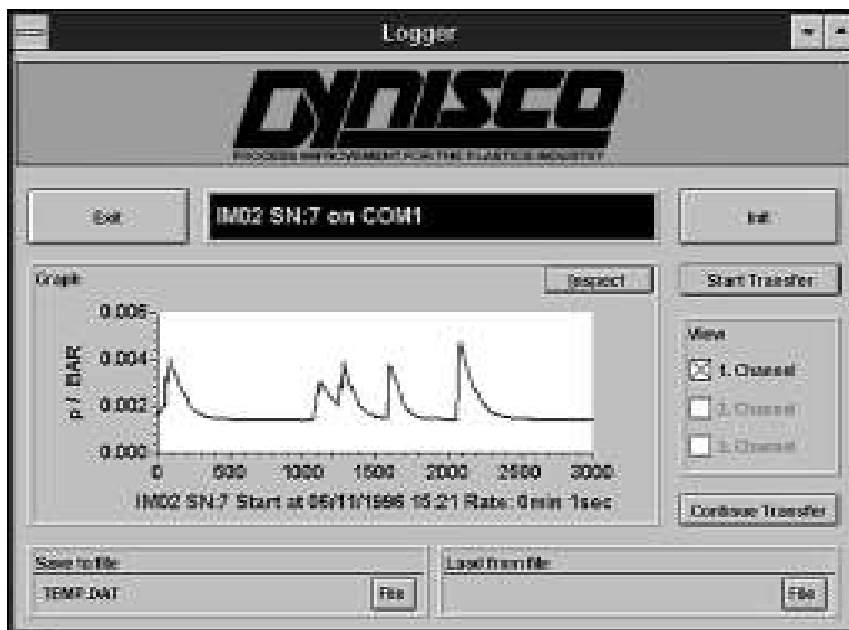



The data transfer always starts with the last recording and can be extended to read out the entire memory. The memory may be read out as many times as needed.

### 8.10.2 Time Allocation

After each recording (**LIN\***, **PST\***, **REC**) the calibrator writes the status of its time meter into the memory. When transferring the absolute time axis is calculated from the time set in the PC, the time meter of the calibrator and the recorded time. Therefore, the calibrator must not be turned off between recording and transfer.

During the recording process five additional storage locations for the storage of the time are used for each complete recording cycle.

### 8.10.3 Memory

Each of the functions **LIN\***, **PST\*** and **REC** fill the memory. New data is always archived directly after the last recorded value, thus continuously filling the memory. Since these instruments feature a ring memory new data will only overwrite the oldest data. This ensures that the maximum amount of the most recent data is at your disposal when the memory is full.

Total number of storage locations

Standard: 900

Extended: 8000 (only with memory option)



## 9. Maintenance

9.1	Cleaning	39
9.2	Priming the Pressure System	39
9.3	Replacing the Battery	40
9.4	Recalibration	41
9.5	Repair	41

### 9.1 Cleaning

**ATTENTION** In order to clean the instrument do not use caustic or aggressive detergents.

**ATTENTION** Clean front side of the instrument by means of a wet, soft cloth.

### 9.2 Priming the Pressure System

If the desired pressure is not reached the system must be primed.

Completely release pressure. Open valve (3) and screw (7). If the pressure is not zero, activate first **TARA** and then **EXE**.

Purge air from the system by repeatedly pressing the priming pump (10). The system is free of air when air bubbles cease coming out of the return pipe (13). Close shut-off valve (3).



### 9.3 Replacing the Battery



#### **Explosion hazard!**

Batteries must not be thrown into the fire, heated above 100°C or recharged.



#### **Hazard of intoxication!**

Do not open batteries. In case their contents have been swallowed see a doctor immediately.

#### **ATTENTION**

On principle, the batteries used with this instrument must not be thrown away along with other waste but be disposed of by a qualified recycling company.

The calibrator houses a 3.6-V battery (located behind the display) for the calibrator functions.

The calibrator will not indicate a battery low. If the display starts to fade this indicates that the battery charge is weakening. At this point it is recommended to change the battery.

- Turn the display ring beyond the limit stop. It will detach from the main housing.
- Disconnect the battery terminals and remove the old battery.
- Insert new battery.
- Set the display ring back in place.





#### 9.4 Recalibration

A recalibration of the instrument is not required.

The PPS 1100 / 1200 High Pressure Calibrator is also available with DkD certificate (DkD = Deutscher Kalibrierdienst [German body for calibration]).

#### 9.5 Repair

**ATTENTION** Any repairs may only be carried out by **DYNISCO**.

Dispatch defective instruments to your **DYNISCO** branch.  
For the addresses, see back of this operating manual.

### 10. Accessories

- |                         |                    |
|-------------------------|--------------------|
| - memory option         | upon request       |
| - Logger software       | order no. 997Z0088 |
| - calibrator - PC cable | order no. 997Z0089 |



## 11. Fault Finding

11.1	Restarting the Calibrator	42
11.2	Overflow/Overpressure Limit	42

### 11.1 Restarting the Calibrator

If it should occur that the program is locked, meaning that the instrument does not react any more when operating the **F key**, in most cases an interruption of the power supply can reactivate the instrument.

Just follow the procedure described for the 3.6-V battery change and disconnect the instrument from the battery for at least 20 seconds. After reconnection switch on the instrument once more.

### 11.2 Overflow/Overpressure Limit

The calibrator displays a pressure of up to 5 to 10% above the indicated pressure range. If this range is exceeded the display indicates **OVFL** (overflow). Do not increase the applied pressure any more!

**ATTENTION** If the pressure exceeds the indicated pressure range by more than 20%, the sensor may be destroyed.

## 12. Declaration of Conformity

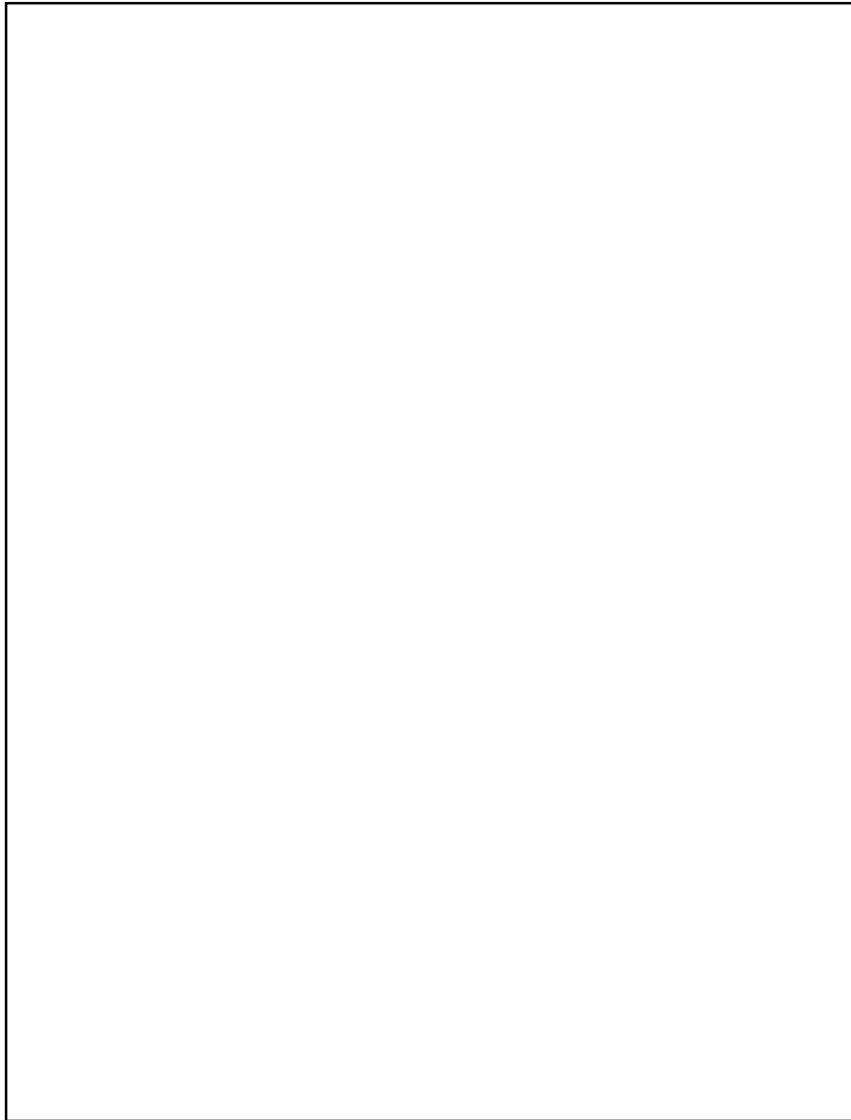
A large, empty rectangular box with a thin black border, intended for the user to provide a Declaration of Conformity. The box is currently blank.

