

## Magnetic inductive flow sensors // VMZ.2 induQ®

### US version available

**Note:** The US versions are separate products.  
The units are not converted, but pre-configured at the factory for the respective variants.

VMZ15



### Product features

- Repeatability  $\leq 1\%$  of reading  
→ Reassures process reliability
- (1) Free cross section  
→ Very low pressure drop
- (2) Works independent from position
- No moving parts  
→ No wear, insensitive to particles
- Six nominal diameters available
- Hastelloy® option available  
→ Suitable for corrosive liquids
- Insensitive to changes of viscosity  
→ Consistent accuracy
- High sampling rate  
→ Works for oscillation flow
- Delivery includes works calibration certificate

### Medium



Measuring pipe PVDF:  
-15...80 °C (non-freezing)  
5...176 °F (non-freezing)

Measuring pipe POM:  
-15...60 °C (non-freezing)  
5...140 °F (non-freezing)

### Works calibration certificate

- Traceable by serial number
- 100% final testing in a water test bench
- 6 points calibration

1



### Markets/Applications:

- **General Engineering:**  
Measuring of cooling water, measuring of waste water, dosing of mold release agents
- **Cleaning Industry:**  
Dosing of detergents and other additives
- **Concrete Production:**  
Dosing of agents and colours
- **Agriculture and Livestock:**  
Dosing of water, fertilizer, fungicides and pesticides, measuring of water and liquid feed supplements
- **Exhaust Gas Cleaning:**  
Dosing of AdBlue

### Highlights

- Cost optimised plastic version
- Compact lightweight construction
- Specially for series applications
- Best price-performance ratio

# Technical data

Type	IVMZ03	IVMZ06	IVMZ08	IVMZ15	IVMZ20	IVMZ25
<b>Technical data</b>						
<b>Nominal diameter</b>	DN 3	DN 6	DN 8	DN 15	DN 20	DN 25
<b>Nominal pipe size</b>	1/16"	1/4"	1/4"	1/2"	3/4"	1"
<b>Process connection [male thread]</b>	G3/8	G1/2	G1/2	G3/4	G 1	G 1 1/4
<b>Process connection [male thread]</b>	3/8" NPT	1/2" NPT	1/2" NPT	3/4" NPT	1" NPT	1 1/4" NPT
<b>Inner diameter [mm]</b>	3	6	8	14	18	25
<b>Inner diameter [inch]</b>	0.118	0.31	0.31	0.55	0.71	0.98
<b>Flow range [l/min]</b>	0.1...2	0.25...5	1...20	2.5...50	5...200	12.5...250
<b>Flow range [US gpm]</b>	0.026...0.53	0.066...1.3	0.26...5.3	0.66...13.2	1.3...53	3.3...66
<b>Accuracy*</b>	±0.7 % of reading ±0.3 % of range					
<b>Repeatability</b>	±1 %					
<b>Response time</b>	<100 ms					
<b>Signal output starting from [l/min]</b>	0.05	0.1	0.25	1	4	5
<b>Signal output starting from [US gpm]</b>	0.013	0.026	0.07	0.27	1.06	1.32
<b>Max. Flow rate [l/min]</b>	2.5	6	25	60	240	300
<b>Max. Flow rate [US gpm]</b>	0.66	1.58	6.6	15.8	63.4	79.2
<b>Medium / min. conductivity of medium</b>	Water and other conductive liquids / 20 µS/cm					
<b>Medium temperature</b> → Measuring pipe PVDF → Measuring pipe POM	-15...80 °C (non-freezing) -15...60 °C (non-freezing)					
<b>Medium temperature</b> → Measuring pipe PVDF → Measuring pipe POM	5...176 °F (non-freezing) 5...140 °F (non-freezing)					
<b>Ambient temperature</b>	-15...60 °C					
<b>Ambient temperature</b>	5...140 °F					
<b>Storage temperature</b>	-15...60 °C					
<b>Storage temperature</b>	5...140 °F					
<b>Max. pressure rating</b>	10 bar at 20 °C, 8 bar at 40 °C, 6 bar at 60 °C, 5 bar at 80 °C					
<b>Max. pressure rating</b>	145 psi at 68 °F, 116 psi at 104 °F, 87 psi at 140 °F, 73 psi at 176 °F					
<b>Indications</b>	LED green, flow proportional flashing					
<b>Degree of protection EN 60529</b>	IP65 (with attached cable socket)					
<b>Electrical data</b>						
<b>Electrical connection</b>	4 pin plug connector M12 x 1					
<b>Power supply</b>	12...24 VDC (±10 %) (With analog output 0.5...10 V: 16...24 VDC (±10 %))					
<b>Power consumption</b>	Typical 1.1 W, max. 3.6 W					
<b>Electrical protection measures</b>	Short-circuit proof and polarity protection					

\* Test conditions: Ex works, water 23 °C (73 °F)

# Output signals

## Three different versions available:

- Frequency output
- Analogue output 4...20 mA and frequency output
- Analogue output 0.5...10 V and frequency output (Only available with power supply 16...24 VDC)

Frequency output	IVMZ03	IVMZ06	IVMZ08	IVMZ15	IVMZ20	IVMZ25
<b>Pulse rate [pulses/l]*</b>	10 000	4000	1000	400	200	80
<b>Pulse rate [pulses/gallon]*</b>	30 000	15 000	3000	1500	750	300
<b>Resolution [ml/pulse]*</b>	0.1	0.25	1	2.5	5	12.5
<b>Signal shape</b>	Square wave signal, pulse duty ratio 50:50, Push-Pull NPN open collector PNP open collector					
<b>Signal current</b>	Max. 100 mA					

Analogue output 4...20 mA	IVMZ03	IVMZ06	IVMZ08	IVMZ15	IVMZ20	IVMZ25
<b>Corresponds to flow rate [l/min]**</b>	0...2	0...5	0..20	0...50	0...200	0...250
<b>Corresponds to flow rate [US gpm]**</b>	0...0.53	0...1.3	0...5.3	0...13.2	0...53	0...66
<b>Max. burden</b>	250 Ω against GND					

Analogue output 0.5...10 V	IVMZ03	IVMZ06	IVMZ08	IVMZ15	IVMZ20	IVMZ25
<b>Corresponds to flow rate [l/min]**</b>	0...2	0...5	0..20	0...50	0...200	0...250
<b>Corresponds to flow rate [US gpm]**</b>	0...0.53	0...1.3	0...5.3	0...13.2	0...53	0...66

\* Other pulse rates/resolutions available on request, optional: output signal with lower frequency, designed specifically for connection to digital PLC inputs

\*\* Other ranges available on request

# Typical pressure drop

## Typical pressure drop IVMZ03

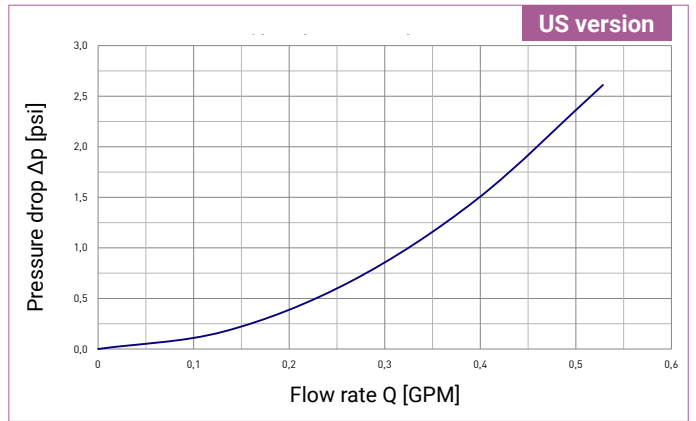
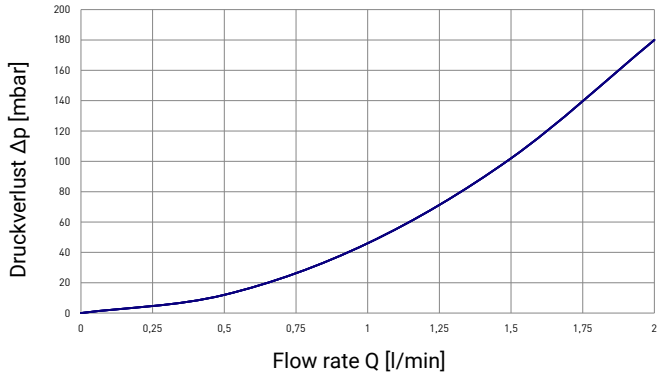

## Typical pressure drop IVMZ06

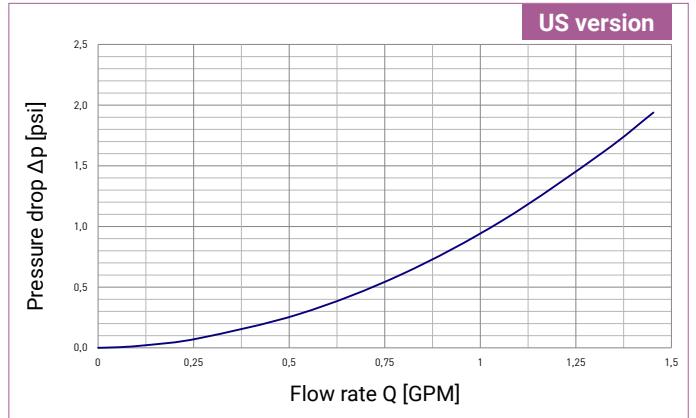
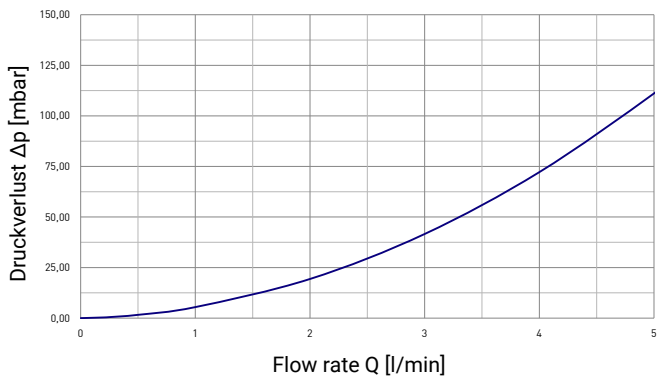

## Typical pressure drop IVMZ08

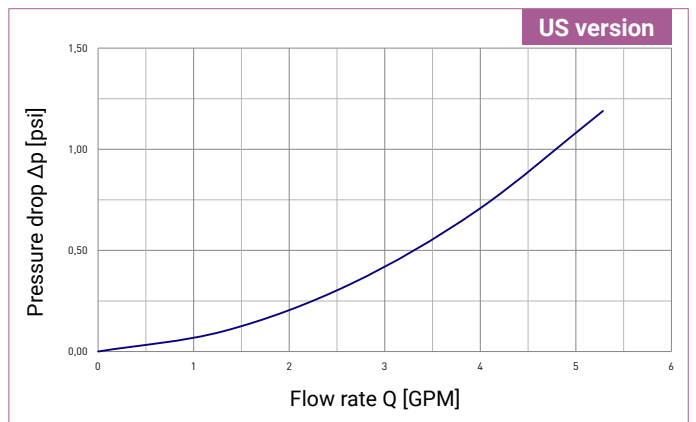
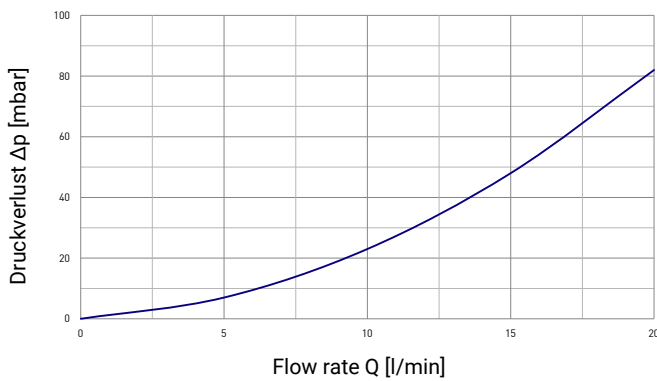

# Typical pressure drop

## Typical pressure drop IVMZ15

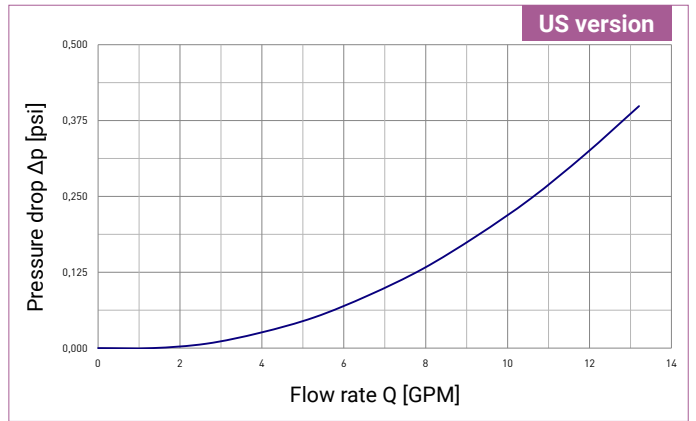
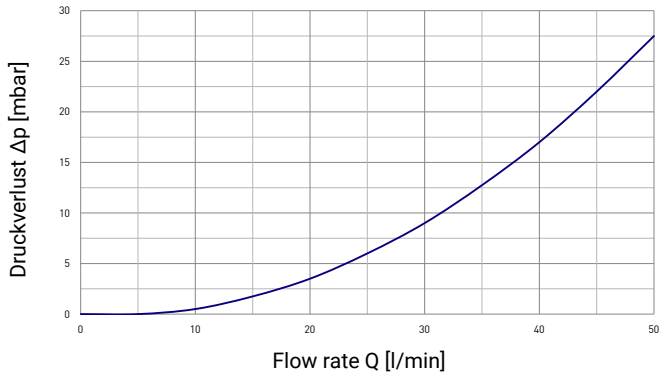

## Typical pressure drop IVMZ20

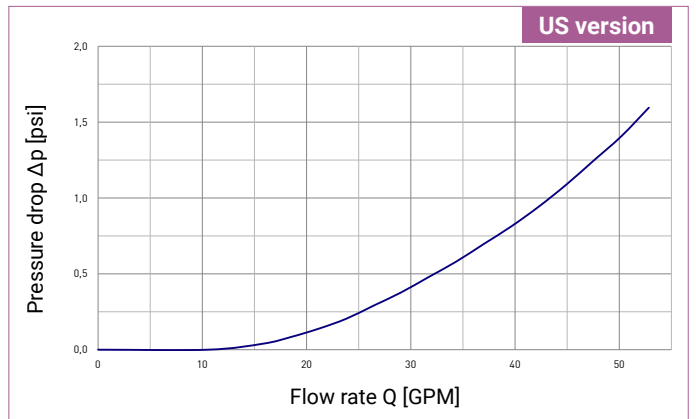
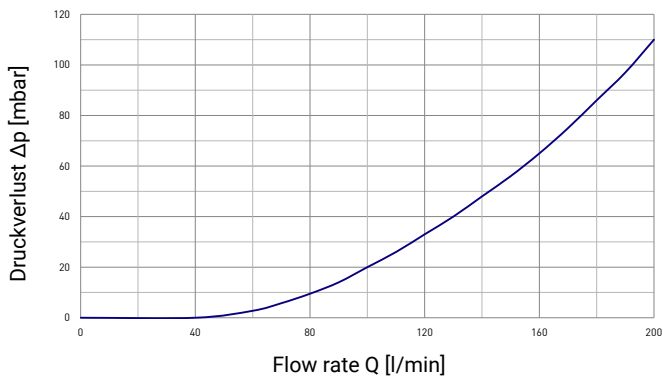

## Typical pressure drop IVMZ25

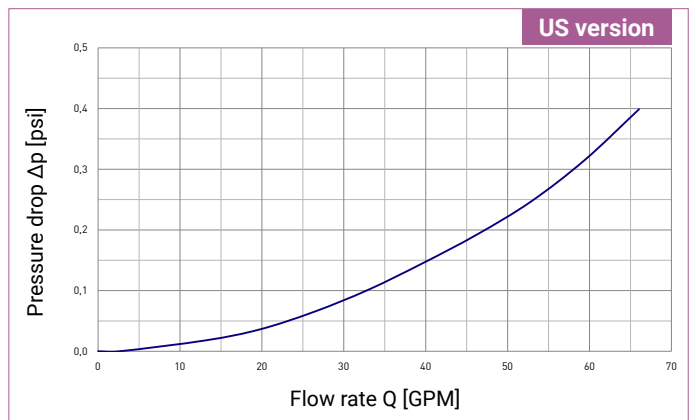
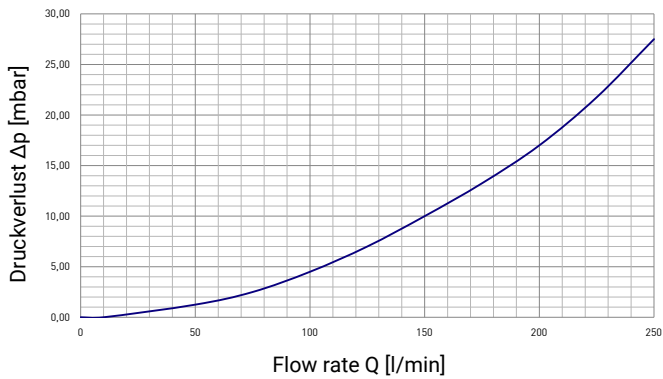

# Technical drawings

IVMZ03 / IVMZ06 / IVMZ08 / IVMZ15 / IVMZ20

IVMZ25

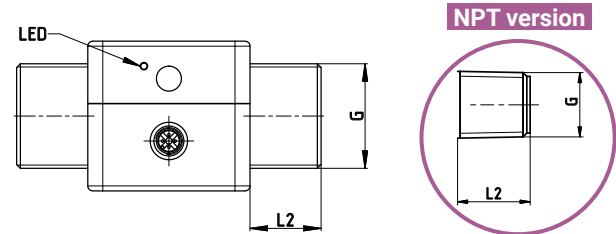
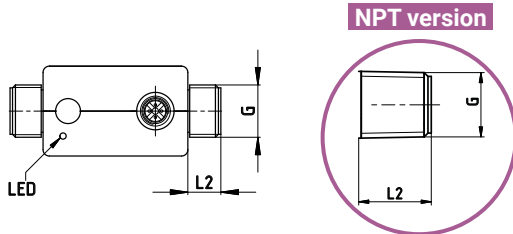
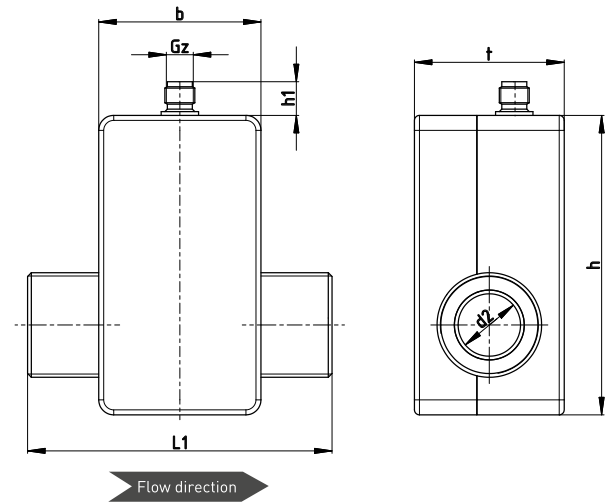
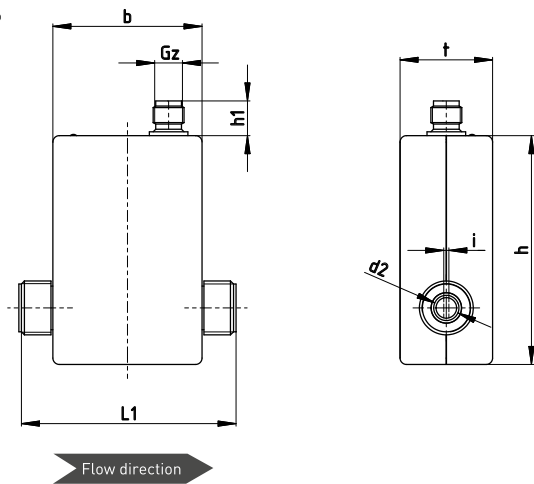

## Dimensions

Dimensions [mm]										
Type	L1	L2	G	d2	b	Gz	h	h1	t	i
IVMZ03	85	13	G $\frac{3}{8}$ B	Ø 3	58	M12 x 1	89	13.5	36	
IVMZ06	85	13	G $\frac{1}{2}$ B	Ø 8	58	M12 x 1	89	13.5	36	2
IVMZ08	85	13	G $\frac{1}{2}$ B	Ø 8	58	M12 x 1	89	13.5	36	
IVMZ15	90	16	G $\frac{3}{4}$ B	Ø 14	58	M12 x 1	89	13.5	36	
IVMZ20	90	16	G1 B	Ø 18	58	M12 x 1	89	13.5	36	
IVMZ25	122	28,5	G1 $\frac{1}{4}$ B	Ø 25	65	M12 x 1	120	13.5	60	
Dimensions [inch]										
IVMZ03	3.68	0.67	$\frac{3}{8}$ - 18 NPT	Ø 0.118	2.28	M12 x 1	3.5	0.53	1.42	
IVMZ06	4	0.83	$\frac{1}{2}$ - 14 NPT	Ø 0.315	2.28	M12 x 1	3.5	0.53	1.42	0.08
IVMZ08	4	0.83	$\frac{1}{2}$ - 14 NPT	Ø 0.315	2.28	M12 x 1	3.5	0.53	1.42	
IVMZ15	4.02	0.83	$\frac{3}{4}$ - 14 NPT	Ø 0.551	2.28	M12 x 1	3.5	0.53	1.42	
IVMZ20	4.41	1.02	1 - 11.5 NPT	Ø 0.708	2.28	M12 x 1	3.5	0.53	1.42	
IVMZ25	4.8	1.04	1 $\frac{1}{4}$ - 11.5 NPT	Ø 0.984	2.56	M12 x 1	4.72	0.53	2.36	

# Materials

Materials		
Not in contact with fluid	G thread	NPT thread
Housing	ABS	
In contact with fluid		
Electrodes and earthing rings	Stainless steel 1.4404 or Hastelloy C®	
Measuring pipe and process connections	POM or PVDF	PVDF (POM on request)
O-rings	EPDM or FKM for version with Hastelloy C®	

# Article numbers

Order code				
Flow range				
0.1...2 l/min	IVMZ032S1			4000
0.25...5 l/min	IVMZ063S1			4000
1...20 l/min	IVMZ083S1			4000
2.5...50 l/min	IVMZ154S1			4000
5...200 l/min	IVMZ205S1			4000
12.5...250 l/min	IVMZ256S2			4000
Measuring pipe and electrode materials				
POM, electrodes and earthing rings made of stainless steel 1.4404		DE		
PVDF, electrodes and earthing rings made of stainless steel 1.4404		PE		
POM, Electrodes and earthing rings made of Hastelloy C®		DB		
PVDF, Electrodes and earthing rings made of Hastelloy C®		PB		
Output signal				
Frequency signal (Push-Pull)			GY	
Frequency signal (Push-Pull) and Analogue signal 4...20 mA			AY	
Frequency signal (Push-Pull) and Analogue signal 0.5...10 V			VZ	
<b>Example order number</b>	<b>IVMZ032S1</b>	<b>PE</b>	<b>GY</b>	<b>4000</b>

Order code [US version]				
Flow range				
0.026...0.53 US gpm	IVMZ03BS1			400A
0.066...1.3 US gpm	IVMZ06CS1			400A
0.26...5.3 US gpm	IVMZ08CS1			400A
0.66...13.2 US gpm	IVMZ15DS1			400A
1.3...53 US gpm	IVMZ20ES1			400A
3.3...66 US gpm	IVMZ25FS2			400A
Measuring pipe and electrode materials				
PVDF, electrodes and earthing rings made of stainless steel 1.4404		PE		
PVDF, Electrodes and earthing rings made of Hastelloy C®		PB		
Output signal				
Frequency signal (Push-Pull)			GY	
Frequency signal (Push-Pull) and Analogue signal 4...20 mA			AY	
Frequency signal (Push-Pull) and Analogue signal 0.5...10 V			VZ	
<b>Example order number</b>	<b>IVMZ03BS1</b>	<b>PE</b>	<b>GY</b>	<b>400A</b>





# Options

Options	
For type	On request
IVMZ	<b>Frequency output</b> Signal shape: NPN or PNP open collector <b>O-Ring</b> Material: FKM

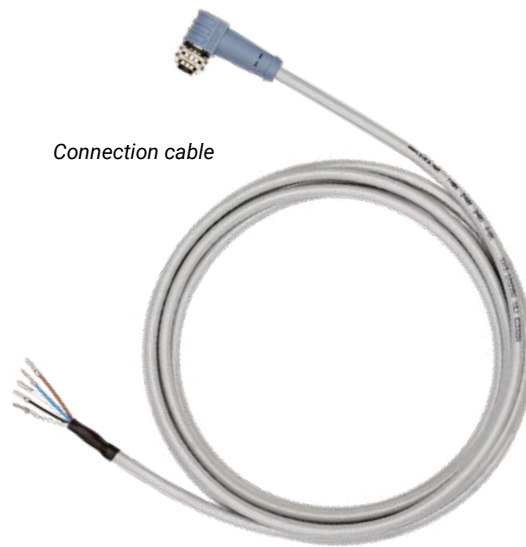
# Accessories

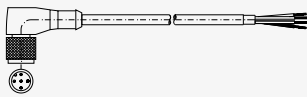

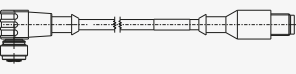
Order code				
Accessories		Length [m]	Length [inch]	Order number
	Connection cable with 5 pin cable socket M12 x 1, angle type moulded lead, sheathing material PUR, shielded, (Tmax = 80 °C / 176 °F), UL-approval	3 m	10 ft	XVT2053
		5 m	16 ft	XVT2009
		10 m	33 ft	XVT2070
	5 pin cable socket M12 x 1 angle type, unassembled			VT1331
	Cable adapter M12 x 1, NPN 5 pin version, angle type for adaptation to model series VMZ (until 2019)			XVMI146