

DPI 705E / 705E-IS

Digital Pressure Indicator User Manual



Introduction

This user manual covers the DPI 705E / DPI 705E-IS measurement instrument and its associated remote probes, PM 700E / PM 700E-IS for pressure measurement and RTD-INTERFACE / RTD-INTERFACE-IS for temperature measurement.

Unless specifically stated in a section all references to DPI 705E cover both DPI 705E (non-Intrinsically Safe) and DPI 705E-IS (Intrinsically Safe). This also applies to PM 700E, PM 700E-IS and RTD-INTERFACE, RTD-INTERFACE-IS.



DPI 705E



DPI 705E-IS



RTD-INTERFACE



PM 700E (Absolute, Gauge)



PM 700E (Differential)

DPI 705E Series Digital Pressure Indicator

The Druck DPI 705E pressure indicator uses a silicon transducer to produce a pressure reading in various pressure measurement units. These user instructions include the operations for all DPI 705E Pressure Indicators, safety instructions and the requirements for intrinsically safe instruments.

The PM 700E provide a remote pressure sensor function for the DPI 705E to allow more convenient connection when direct connection of the handheld instrument would be inconvenient. The PM 700E is a “plug and play” device holding its own calibration data, so it can be used to have multiple pressure range sensors available for immediate use with a single DPI 705E instrument.

The RTD-INTERFACE is a remote interface for use with the DPI 705E or the DPI 620G to allow connection of a PT 100 RTD probe to the instrument for the purpose of measuring temperature.

For all accuracy specifications etc refer to the relevant product datasheet, available for download from Druck.com/essential.

Commercial and Intrinsically Safe Product versions

The DPI 705E is available as either non-Intrinsically Safe (blue in color) or Intrinsically safe (yellow in color) versions, with case coloring used as well as labeling to indicate the version.

The remote pressure sensor PM 700E and the remote RTD interface RTD-INTERFACE are available as either non-Intrinsically Safe or Intrinsically safe versions. The outer metal body of the product is marked with its part number and relevant approvals.

Safety

For all safety information on both commercial and Intrinsically Safe versions refer to the Quick Start and Safety Manual provided with the unit and also available for download on Druck.com/essential.

Pressure Connectors and Adaptors

The DPI 705E and PM 700E are fitted with female G1/8 pressure connectors for the main pressure port P1 for ranges 25 mbar - 200 bar(0.36 psi - 2900 psi). For pressures 350 bar-1400 bar(5000 psi - 20000 psi) Autoclave male pressure connectors are used. The main pressure port P1 is shown on the left in the picture below.

For differential units/sensors fitted with a reference port a Legris adaptor is fitted giving a 4mm tubing fitting. This is shown as the Ref port on the right in the image below.



Various adaptors are available (either as accessories or configured when ordering) for the G1/8 connection to convert to other standards. Please see datasheet for full details.

Part Code	Description
IO-ADAPT-G1/4	G1/4 female adaptor
IO-ADAPT-1/4NPT	1/4 NPT adaptor
IO-ADAPT-1/8NPT	1/8 NPT adaptor
IO-ADAPT-QF	Quick-fit hose adaptor

See below for cautions on adaptor and connector fitting:

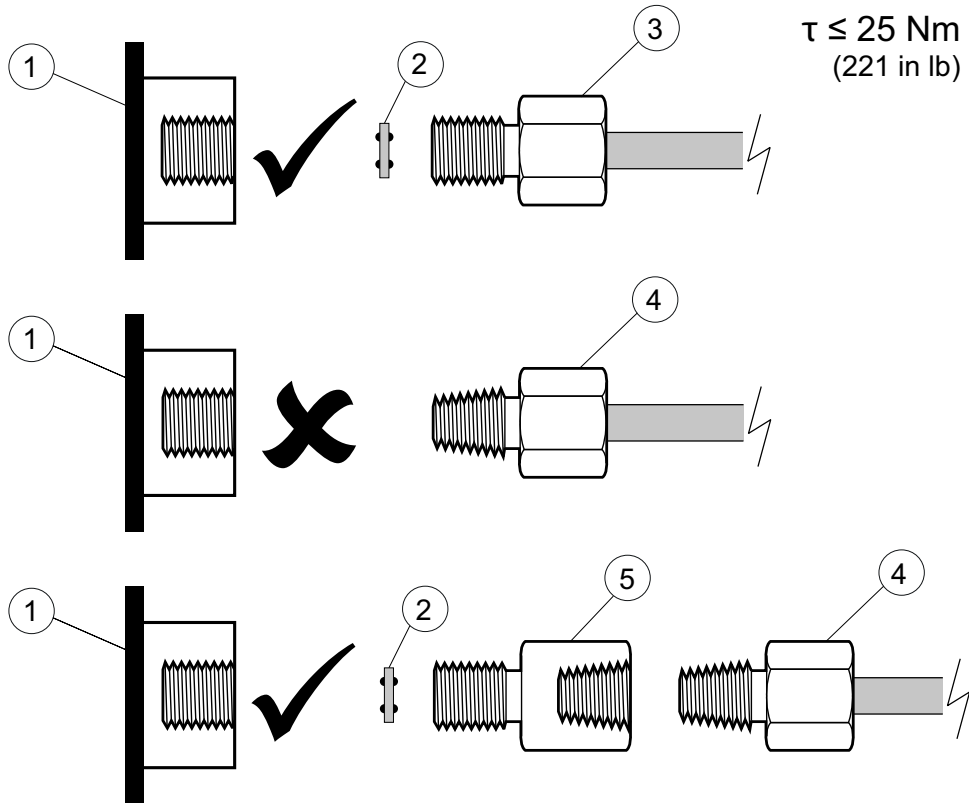

- 1 DPI 705E or PM 700E G1/8 port
- 2 Bonded seal 110N3018
- 3 ISO 228/1 G1/8
- 4 NPT thread pressure connector IO-ADAPT-1/4NPT or IO-ADAPT-1/8NPT
- 5 NPT female to G1/8 male adapter part number IO-ADAPT-1/4NPT

Batteries

For compatible battery types refer to Quick Start and Safety Manual provided with the unit and also available for download on [Druck.com/essential](https://www.druck.com/essential)

The instrument requires 4 x AA/LR6 batteries, fitted as shown below. Use a small Posidrive screwdriver to loosen the screws in the battery compartment cover and fit as per the battery orientation shown on the back of the instrument as illustrated below:

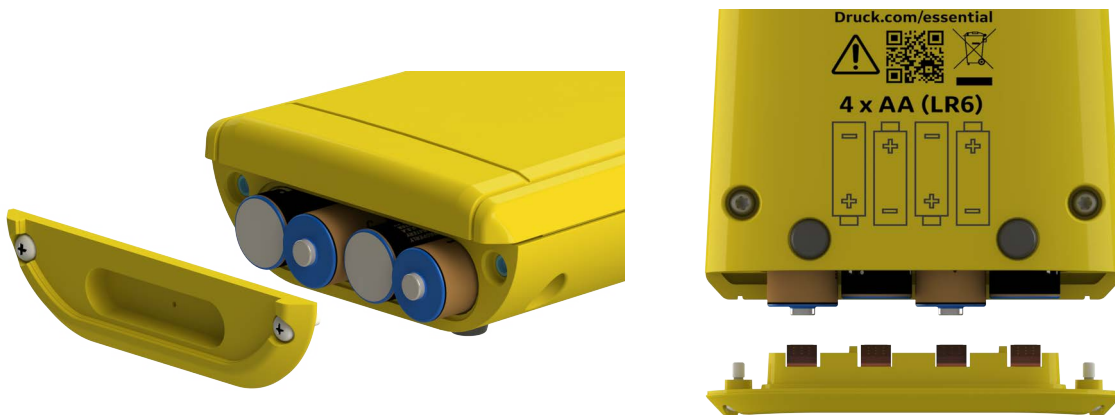

External Sensors

The DPI 705E supports two types of external sensor, both of which connect via a cable into the right-hand side of the unit.

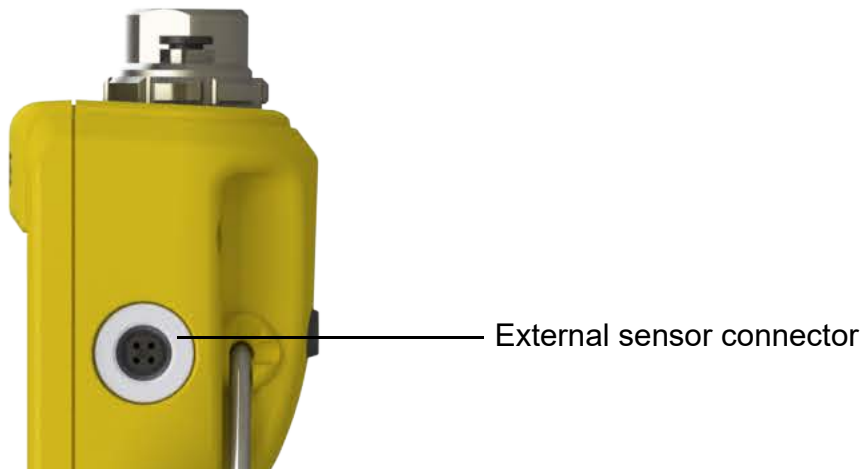

The sensor must be connected via supplied connection cable (it will not engage correctly if directly plugged in). The connectors push in (with polarity protection features aligned) then the outer body rotates clockwise to lock the connector in position. Multiple cables may be used in series (i.e. as extenders). Up to a maximum of 10 in series if very long cabled connections are needed.

When an external sensor is connected it is automatically detected and has precedence over the internal sensors. The display shows “EXT SENSOR” (External Sensor) to show that the reading is from the external sensor. To show a reading from the internal pressure sensor the external sensor must be unplugged.

The external sensor may be either:

- A pressure sensor PM 700E ranging from 25 mbar to 1,400 bar (0.36 psi to 20,000 psi) full-scale.
- A temperature sensor adaptor RTD-INTERFACE which supports a 4-wire PT100 probe.

If a PM 700E pressure sensor is plugged in then the pressure Full-scale will be displayed (only at first plug-in), followed by the calibration due date in days. Normal pressure measurement display will then start.

If an RTD-INTERFACE temperature sensor is plugged in then temperature/resistance full-scale will be displayed (only at first plug-in), followed by the calibration due date in days. Normal resistance or temperature measurement display will then start.

RTD Wiring

The DPI 705E M12 connector is to be connected to an external RTD probe as shown below.







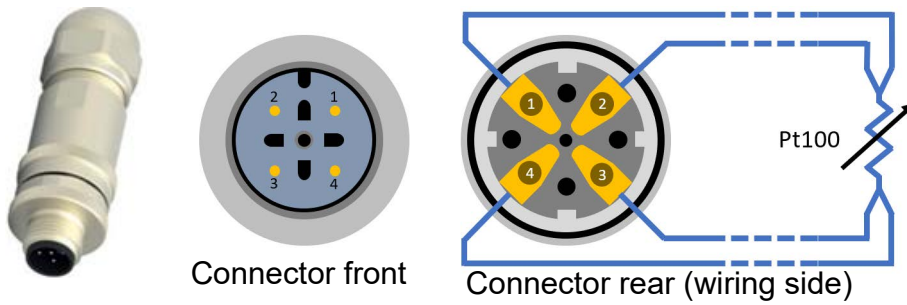





The RTD-INTERFACE is optionally supplied with a field-rewirable M12 connector for customers to connect their own wire-ended RTD's into. This is accessory part number IO-RTD-M12CON.

The pin numbering is printed on the rear of the connector body and is reproduced below for clarity.

Customer M12 connector pinout



Controls and Functions

Function	Control	Description
Power		Turn the instrument on or off.
Filter		Use to get a stable pressure reading over a noisy pressure source. It has a secondary function as a Back key.
Leak		Use to measure pressure leaks over a configurable time interval It has a secondary function as an OK key.
Tare		Set a temporary zero for relative measurements by using the Tare feature. It has a secondary function as an Increment key.
Units		Change the measurement unit of the instrument It has a secondary function as a Next key.
Backlight		Turn the instrument backlight on/off.
Alarm	  (Press Simultaneously)	Set a high and low alarm based on a high/low configurable threshold.
Zero	  (Press Simultaneously)	Set the Zero point for your gauge or differential sensor before performing measurement.
Settings	   (Press Simultaneously)	Perform Advanced operations such as sensor calibration, configure calibration interval, units, user PIN, display lock behavior and factory reset. Also check sensor full-scale values, system date/time, software version and other General settings.

Display Segments

The DPI 705E display segment is explained below:

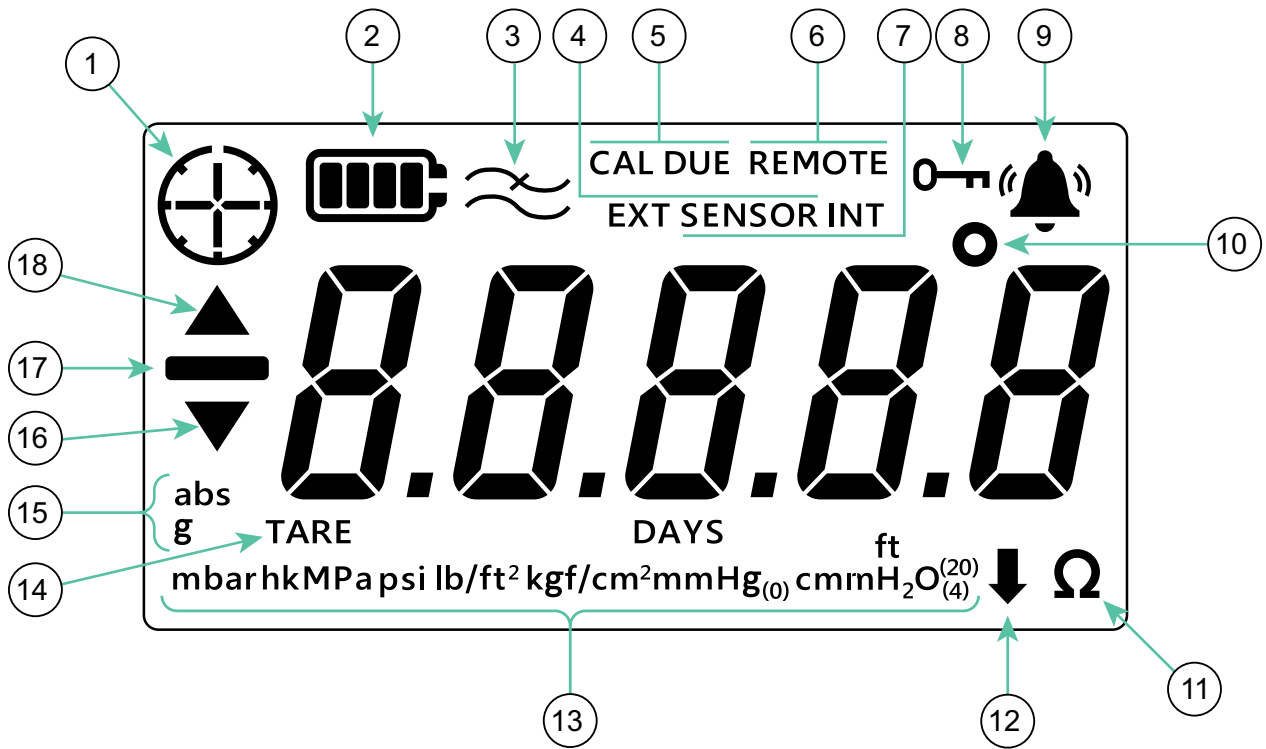

- | | |
|--|---|
| 1. Leak Test Indicator | 2. Battery Level Indicator |
| 3. Filter On Indicator | 4. External Sensor Functional Indicator |
| 5. Calibration Due Indicator | 6. Remote State Indicator |
| 7. Internal Sensor Functional Indicator | 8. Lock Indicator |
| 9. Alarm State Indicator | 10. Temperature Degree Indicator |
| 11. Resistance (Ohms) Indicator | 12. Custom Units Indicator |
| 13. Pressure Units Indicator | 14. Tare Indicator |
| 15. Sensor Type Absolute/Gauge Indicator | 16. Minimum Symbol Indicator |
| 17. Negative Value Indicator | 18. Maximum Symbol Indicator |

Contents

1.	Basic Functionality	1
1.1	Turn on/off	1
1.2	Pressure Measurement	2
1.3	Temperature Measurement	2
1.4	ZERO	3
1.5	TARE	4
1.6	FILTER	4
1.7	UNITS	4
1.8	Backlight	5
2.	Advanced Functionality	5
2.1	Maximum Reading	5
2.2	Minimum Reading	6
2.3	Leak Test	7
2.4	Alarm	8
2.4.1	Set High Alarm	9
2.4.2	Set Low Alarm	10
3.	Settings	12
3.1	Advanced Settings	13
3.1.1	Adjust Sensor Calibration	13
3.1.2	Calibrate Sensor	15
3.1.3	Set Calibration Date	17
3.1.4	Set Calibration Due Interval	17
3.1.5	Change User PIN	18
3.1.6	Units Lock	20
3.1.7	Lock Display	21
3.1.8	Factory Reset	22
3.2	General Settings	23
3.2.1	Full-scale Value	24
3.2.2	Calibration Due Date	24
3.2.3	Audio	25
3.2.4	Auto shutdown	26
3.2.5	Battery Type	27
3.2.6	Date	28
3.2.7	Time	30
3.2.8	Custom Unit	31
3.2.9	Software Version	33
4.	Accessories	35
5.	Error Codes & Diagnostics	36
5.1	Error Codes	36
5.2	Diagnostics	37
6.	Approved Service Centers	37
6.1	Return Goods/Material Procedure	37

1. Basic Functionality

1.1 Turn on/off



INFORMATION If no date has been previously set, a “*DATE*” (Date) symbol is displayed prompting for a system date. Refer to the Section 3.2.6. to set a system date. After the date is set, follow step 3 onwards.



INFORMATION The external sensor has precedence over the internal sensor. This means that if an external sensor is connected, the instrument will measure from the external sensor by default.

To turn on the unit, press the power button briefly. All the segments illuminate on the LCD Display as shown below.

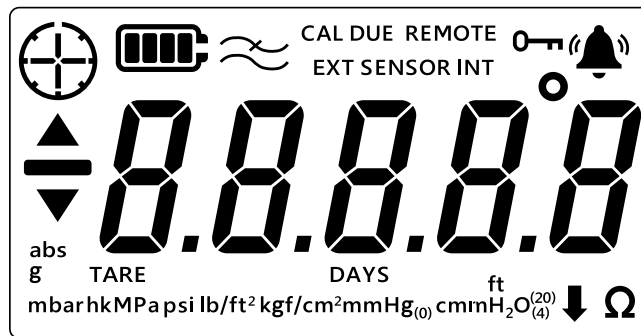

Upon successful power up, the sequence of events that follow are,

1. The backlight turns on (unless disabled).
2. The battery level is displayed.
3. The positive full-scale of the sensor is briefly displayed.

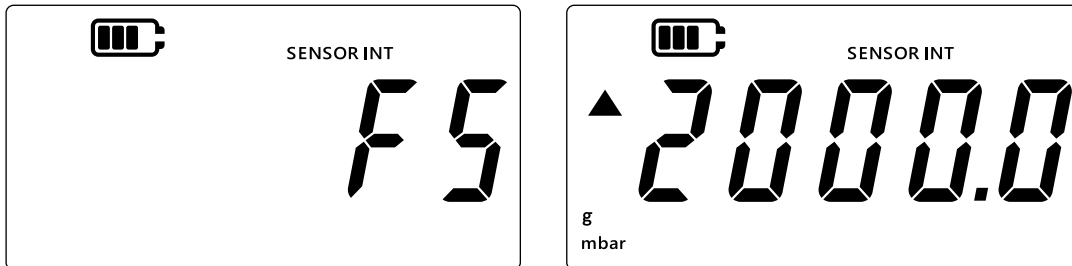

4. The number of days remaining to the next calibration due date are then briefly displayed.

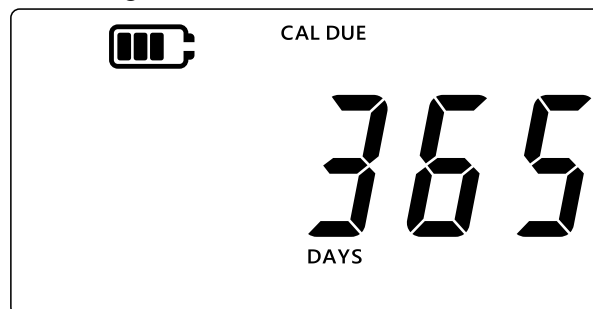

5. The sensor reading screen is then displayed. This is the default state or main screen of the instrument. The example shown below will be used to refer to the sensor reading screen throughout this manual

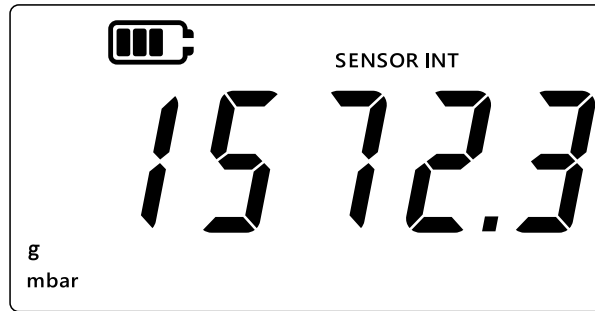

1.2 Pressure Measurement

The DPI 705E can be used to measure pressure from an external pressure source - it does not generate pressure itself.

To measure pressure:

1. Connect an external pressure source to be measured via the P1 pressure port at the top of the instrument.
2. The instrument will display the measured pressure using the internal sensor as shown below.

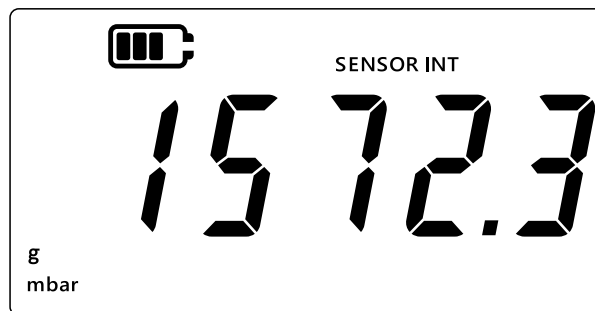

3. To measure pressure via an external sensor, connect an external sensor via the port on the right side of the instrument.
4. The instrument will then measure pressure using the external sensor as shown below.

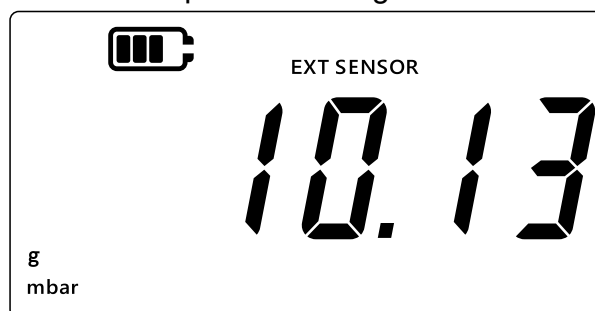

Note: The sensor type (absolute or gauge) will be shown on the display as “abs” or “g”. Differential sensors are indicated as gauge.

1.3 Temperature Measurement

The DPI 705E can be used to measure temperature using the RTD-INTERFACE.

To measure temperature:

1. Connect the RTD-INTERFACE via the port on the right of the instrument, and connect an RTD-PROBE or PT100 to the RTD-INTERFACE.

- The instrument will measure temperature in Degrees Celsius by default as shown below.

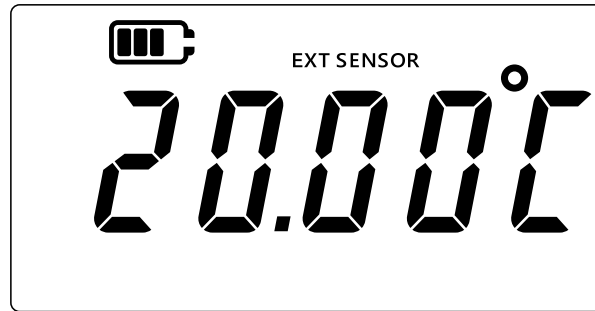

- To change the temperature unit, press the **UNITS** key. The temperature reading is then shown in Degrees Fahrenheit.

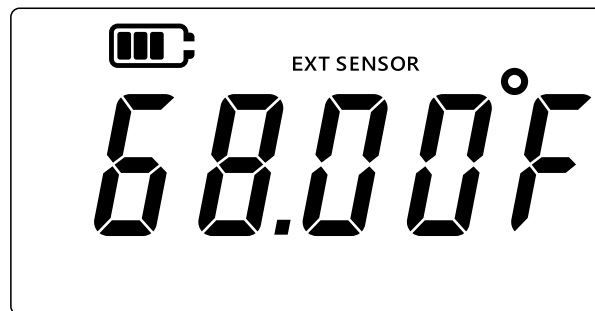

- To change the measurement unit, press the **UNITS** key again. The reading is then shown in Ohms.

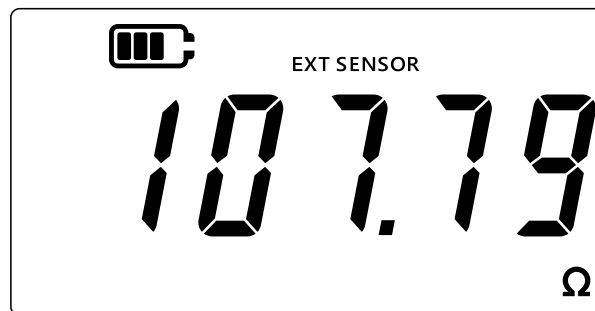

1.4 ZERO



CAUTION Zero is a function that causes a non-reversible adjustment of the zero reading and effectively adjusts the calibration of the sensor. Do not confuse zero with tare - please read both sections if uncertain.

A zero should be performed on a Gauge or Differential pressure instrument before measuring pressure. The zero function is not available on absolute pressure sensors (because absolute vacuum would have to be applied to them to make it valid) and is not available on RTD-Interface.

To perform a zero:

- Open all pressure ports to atmospheric pressure.
- Press the **≈** and **TARE** keys together.

- The display will briefly show “2Er0” (Zero) indicating that the zero function has been successful.

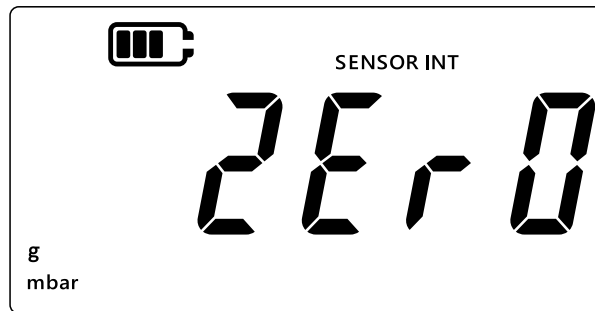

1.5 TARE

The tare function allows a temporary offset to make the reading go to zero at the point when the **TARE** key is pressed. This offset is maintained until the **TARE** key is pressed again, or the unit is powered off.

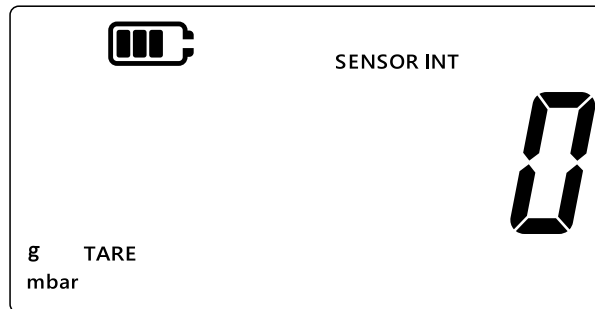

To toggle the tare functionality on or off press the **TARE** key. If tare is active then “TARE” will be shown on the display as below.





1.6 FILTER

The filter functionality allows a filtered pressure reading by showing a rolling average of last 10 measurements. This will give a more stable reading of a noisy measurement.

To toggle the filter functionality,

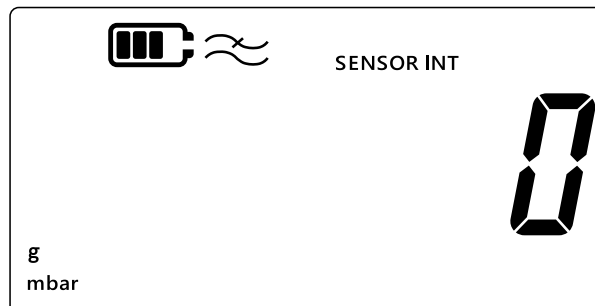

- Press the  key.
- The current status of the filter function will be displayed.
- The “” (Filter) indication on display means the filter functionality is on. The device will start displaying filtered readings on the display.



- Press the  key again to turn the filter functionality off. The filter symbol will disappear.

1.7 UNITS

To change the pressure units of the display:

1. Ensure the sensor reading (home) screen is shown. Otherwise, press the  key to go back to the pressure reading screen.
2. Press the  key to go to the next unit until the desired unit of measure is displayed.
Note: Some pressure units are not appropriate for some pressure ranges (e.g. mbar units for a 1400 bar sensor, bar for a 25 mbar sensor etc.).
3. The units listed below are supported by DPI 705E.

Pressure Sensor Units:		
mbar	lb/ft ²	cmH ₂ O (4°C)
bar	kgf/cm ²	mH ₂ O (4°C)
Pa	kgf/m ²	inH ₂ O (4°C)
hPa	mmHg (0°C)	inH ₂ O (20°C)
kPa	mHg (0°C)	ftH ₂ O (4°C)
MPa	inHg (0°C)	ftH ₂ O (20°C)
psi	mmH ₂ O	↓ Custom Unit
RTD Interface Units:		
°F	Ω (Resistance)	°C

Custom Unit functionality allows a custom scaling factor for any one of the current units which then automatically gets applied for all units. See Section 3.2.8 for more details.

A custom unit is indicated by a down arrow on the bottom right corner of the display.

1.8 Backlight

The backlight works in 3 modes:

Default mode

- Backlight turns on for a few seconds at any key press (including brief press of backlight key).

Permanently on mode

1. Press and Hold the backlight key on the instrument until the backlight turns on.
2. A double beep is heard if audio is enabled.
3. The backlight should then remain on (regardless of key press).
4. To return the backlight to default mode short press the backlight key.

Permanently off mode

1. Press and Hold the backlight key on the instrument until the backlight turns off.
2. A double beep is heard if audio is enabled.
3. The backlight should then remain off (regardless of key press).
4. To return the backlight to default mode short press the backlight key.

2. Advanced Functionality

2.1 Maximum Reading

The maximum reading is the highest read by the instrument since power up. The value will be reset each time the device is turned off.

To view / reset the maximum pressure reading:

1. Ensure the display is on the sensor reading screen as shown in the example below.

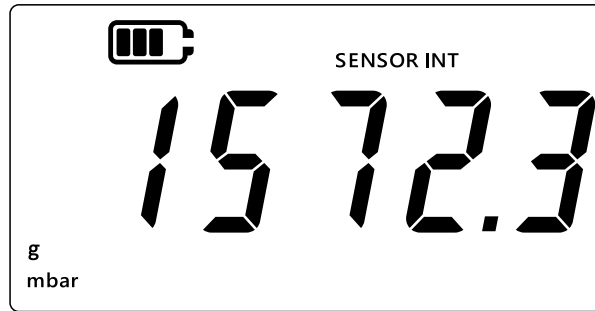



2. Press the  key.
3. The display will then show the maximum recorded reading.

Note:

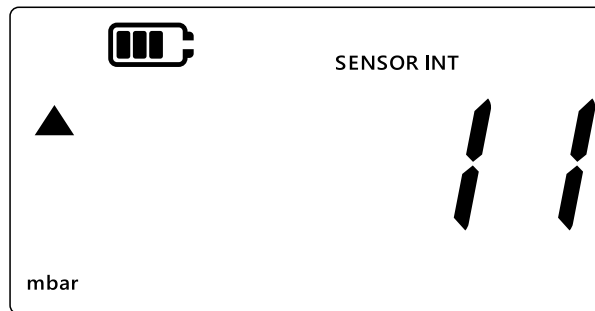
- The up-arrow on the display indicates that the current reading is the maximum pressure reading. e.g. 11 mbar.
- If there is a dash symbol below the up arrow, it means the reading is negative (not shown in current example).



4. To reset the maximum pressure reading, press and hold the  key until a beep sound is heard (if audio is enabled).
5. The reading will then reset, and the unit will immediately start measuring again, but is still only showing the maximum reading on the display - this is effectively Peak Hold mode.
6. Press the  key to exit maximum display mode.

2.2 Minimum Reading

The minimum reading is the lowest read by the instrument since power up. The value will be reset each time the device is turned off.

To view / reset the minimum pressure:

1. Ensure the display is on the sensor reading screen as shown in the example below.

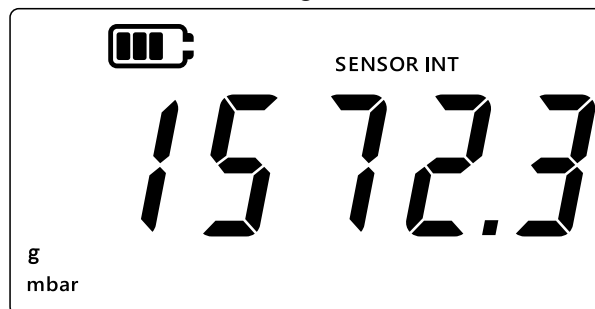



2. Press the  key.
3. The display will show maximum pressure reading, with up-arrow.

- Press the  key again to see the **Minimum Pressure** reading.

Note:

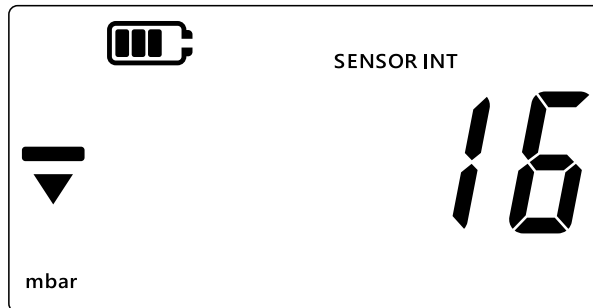
- The down-arrow on the display indicates that the current reading is the minimum pressure reading.
- The dash above the down arrow indicates that the reading is negative. The display below shows -16 mbar.



- To reset the minimum pressure reading, press and hold the  key until a beep sound is heard (if audio is enabled).
- The reading will then reset, and the unit will immediately start measuring again, but is still only showing the minimum reading on the display - this is effectively negative Peak Hold mode.
- Press the  key to exit minimum display mode.



2.3 Leak Test

This feature is used to determine whether there is a leak in the connected system by recording the pressure change over a period of time. Leak test can also be used with the RTD-INTERFACE to record temperature change over time.

To perform a leak test, follow the sequence of steps below:

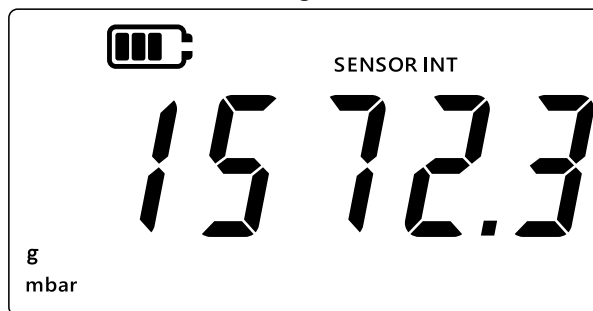
- Ensure the display is on the sensor reading screen.



- Press the  key 3 times.
- A clock symbol appears in the top left corner of the display. The leak test time appears with default at 60 seconds.
- To change the timer value, press the  key, the display will cycle 60, 120, 300 seconds.

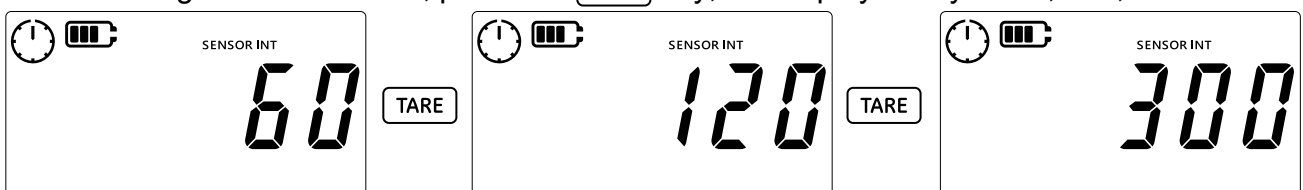

- Press the **LEAK** key to start the leak test for the selected time duration. The timer display counts down and the pointer in the clock symbol will rotate for the specified duration.

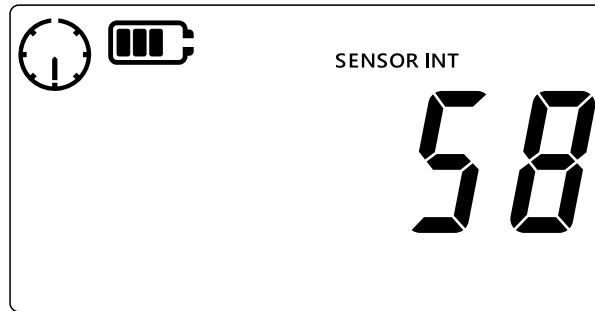

- After the time has elapsed, the display will show the change (leak) rate per minute in either pressure units or temperature/resistance for RTD-INTERFACE. The clock symbol then changes to steady, and the current configured measurement unit will be visible at the bottom of the display.

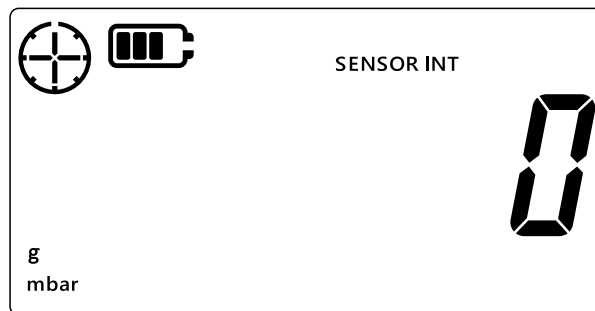

- To leave the Leak Test screen, press the **≈** key.

2.4 Alarm

The alarm feature allows an alarm to be set based on certain conditions. For example, pressure value above or below user set limits.

The steady appearance of a bell icon on the top right corner of the display indicates that the alarm feature is enabled and high and low threshold values for the alarm trigger are already set.

When the alarm is triggered the bell icon flashes, the reading flashes and the backlight flashes. By default, the alarm sounds for 60 seconds but the display flashes until the alarm condition is removed.

To turn the alarm feature on or off:

- Ensure the display is on the sensor reading screen.

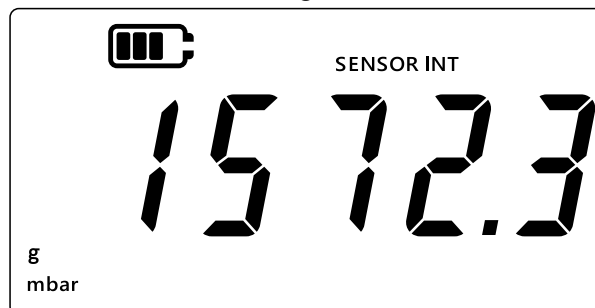

- Press the **TARE** and **UNITS** keys simultaneously.

- The current state of the alarm will be displayed as shown below.

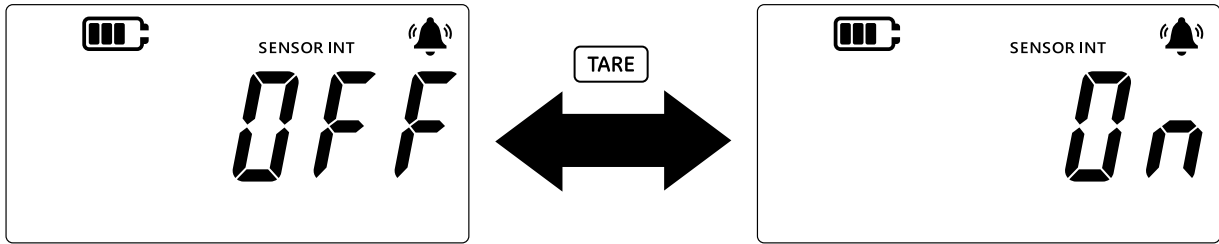

- To change the state of the alarm, press the **TARE** key as shown above.
- Press the **LEAK** key to save the changes and return to the sensor reading screen.
- Once the alarm is on, two alarm types are available:
 - High alarm: Alarm will be triggered when the measurement goes above the high threshold value.
 - Low alarm: Alarm will be triggered when the measurement goes below the low threshold value.

Note:

- The instrument will not trigger an alarm if the alarm state is set to OFF.
- See Section 2.4.1 and Section 2.4.2 to set high/low alarm thresholds.
- High and low alarms are independent of each other. Either one or both can be enabled.

2.4.1 Set High Alarm

The high alarm can be set to provide an alarm when pressure or temperature exceeds the set high threshold value.

Note: The chosen limit must be within the range of the sensor. For example, if a sensor's range covers positive values only, then a negative limit cannot be set.

To set a high alarm:

- Ensure the display is on the sensor reading screen.

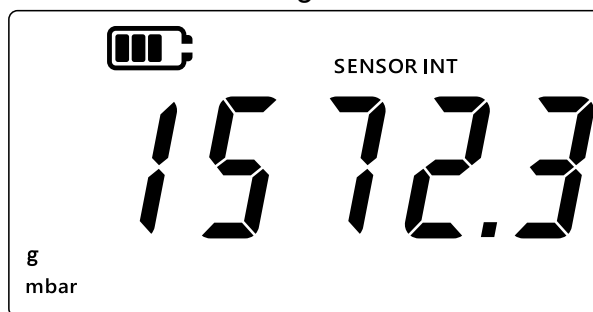

- Press the **TARE** and **UNITS** keys simultaneously.
- The current state of the alarm will be displayed as shown below. Ensure the alarm is set to ON.

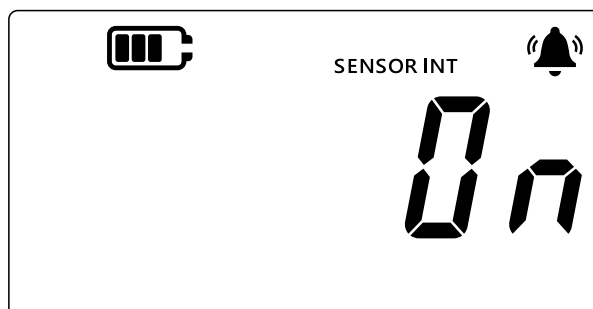

- Press the **[UNITS]** key to navigate to the high alarm screen. The reading value for the high alarm will be shown.

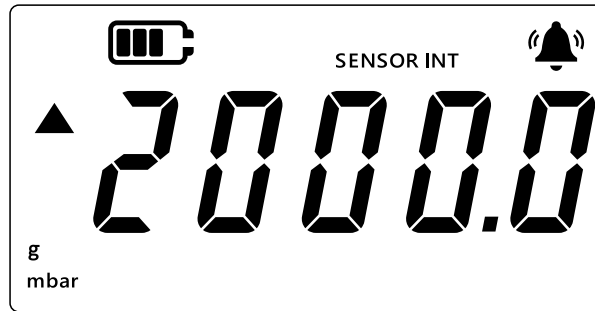

Note:

- The up-arrow on the left indicates that this is the maximum value.
- If no value is set, the below screen indicates that a value must be set.

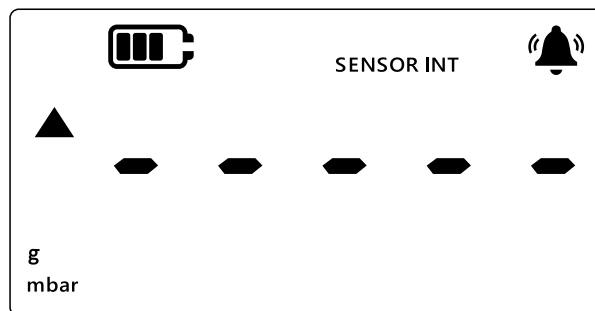

- To change this value, press the **[LEAK↕]** key - the 'current digit' will flash briefly.
- Use the **[TARE]** key to increment the current digit value.
- Use the **[UNITS]** key to move to the next digit.
- When all digits have been processed, press the **[LEAK↕]** key to save the value.

Note:

- To set a negative value, press the **[LEAK↕]** key until the up-arrow and down-arrow symbols flash, then press the **[TARE]** key to toggle the negative value symbol.
- Setting a value beyond the sensor range value produces an error on the screen as shown below. If this happens press the **[LEAK↕]** key and enter the value again.

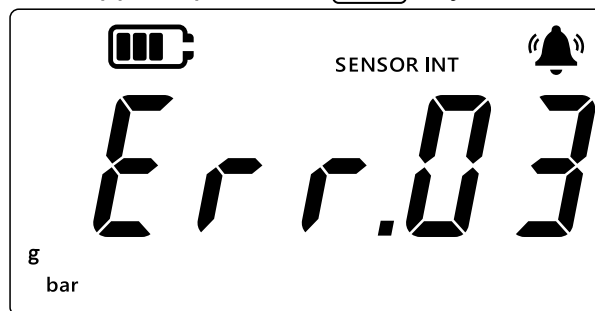

- Press the **[≈]** key to go to the main screen.

2.4.2 Set Low Alarm

The low alarm allows an alarm to be set for when pressure reading goes below the alarm low threshold

To set a low alarm:

1. Ensure the display is on the sensor reading screen.

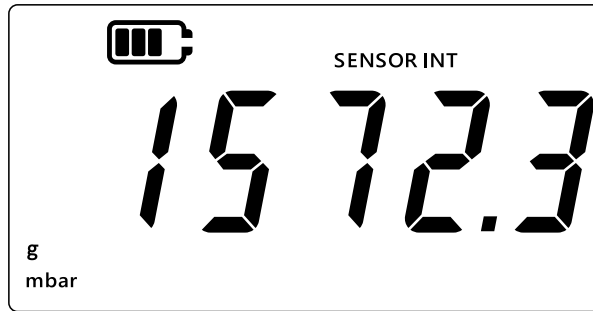

2. Press the **TARE** and **UNITS** keys simultaneously.
3. The current state of the alarm will be displayed as a "ON" (On) or "OFF" (Off). Ensure the alarm is set to ON.
4. Press the **UNITS** key twice to navigate to the low alarm screen. The pressure value set for low alarm will be displayed.

Note:

- The down arrow on the left indicates that this is the low value.
- The dash above the arrow indicates that this is a negative value.

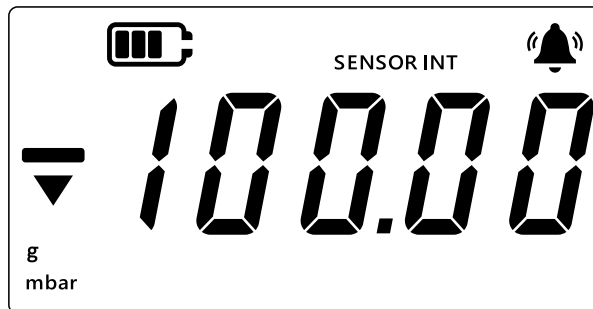

5. To change this value, press the **LEAK** key. The 'current digit' will flash briefly.
6. Use the **TARE** key to increment the current digit value.
7. Use the **UNITS** key to move to the next digit.
8. When all digits have been processed, press the **LEAK** key to save the value.

Note:

- To set a negative value, press the **LEAK** key until the up-arrow and down-arrow symbols flash, then press the **TARE** key to toggle the negative value symbol.
- Setting an invalid threshold will result in an error message. For example, Error.03 which means the value is out of bounds. If this happens press the **LEAK** key and enter the value again.

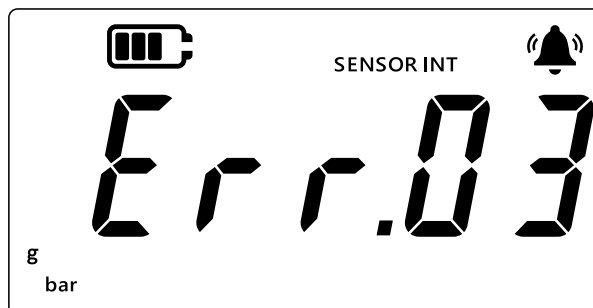



9. Press the **HOME** key to go to the main screen.

3. Settings

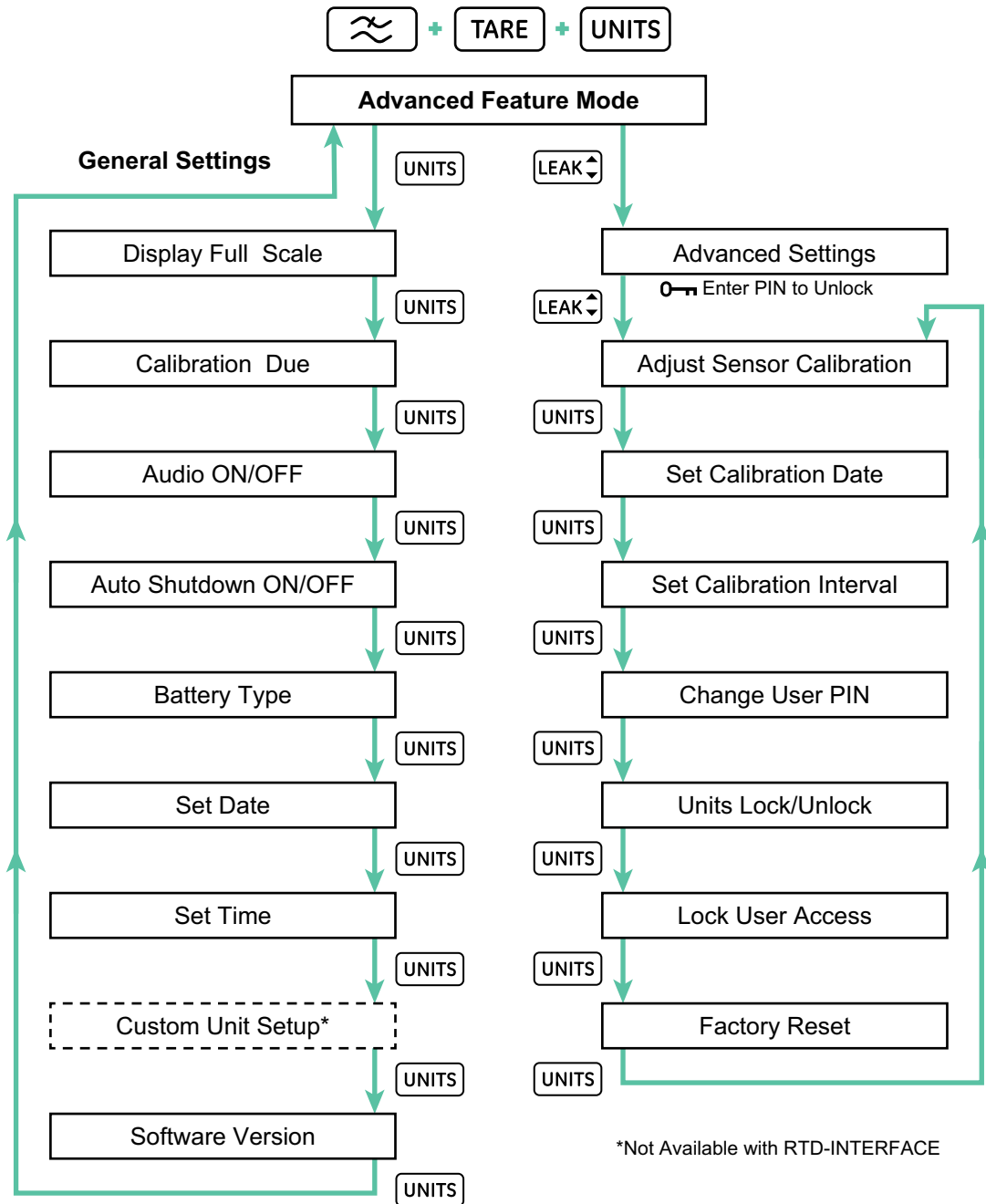
The below flow diagram shows the menu sequence for advanced features on the instrument.



There are two categories of Settings within DPI 705E, General Settings and Advanced Settings. To access these settings:

1. Ensure the display is on the sensor reading screen.
2. Press the ,  and  keys simultaneously.

3. The display will show “*Rdu*” (Advanced) which indicates that **Settings** function is selected.

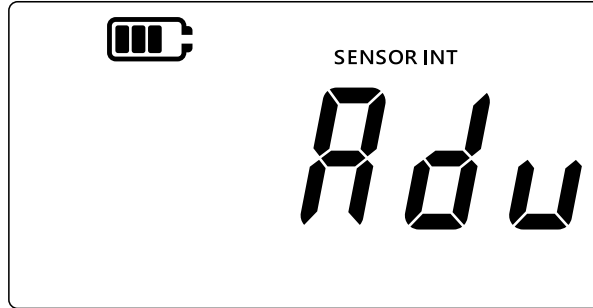

4. Two types of operations are available:

a. Go to Advanced Settings

There are 7 advanced settings which can be accessed by pressing the **LEAK** key on the “*Rdu*” (Advanced) screen. A PIN will be requested before to gain access to these settings.

b. Go to General Settings

There are 9 general settings which can be accessed by pressing the **UNITS** key from the “*Rdu*” (Advanced) screen.

The sections below explain the two categories of settings

3.1 Advanced Settings

These features can be accessed through the Advanced Settings which requires a 4-digit unlock PIN.

Setting	Description
Adjust Sensor Calibration	Perform calibration of the sensor
Set Calibration Date	Change calibration date
Set Calibration Due Interval	Change calibration interval (default 365 days)
Change User PIN	Change user PIN or lock code
Units Lock	Disable or enable measurement units (all units are enabled by default)
Lock Display	Lock user interface to allow restricted access to certain functionality
Factory Reset	Reset the instrument to its factory settings



INFORMATION The default PIN is 4321. It is highly recommended to change the default PIN for security reasons. Instructions to change the user PIN are defined in Section 3.1.5.

3.1.1 Adjust Sensor Calibration

This feature adjusts the calibration of the internal or external sensor. The same procedure is used for the internal and external sensor. The display shows “SENSOR INT” (Internal Sensor) when calibrating the internal sensor and “EXT SENSOR” (External Sensor) for the external sensor.

Note: All sensors allow a two point calibration only.

It is recommended to set calibration point “*CP1*” (Calibration Point 1) near zero and “*CP2*” (Calibration Point 2) near the full-scale value of the sensor.

To calibrate the sensor:

1. Ensure the display is on the sensor reading screen.

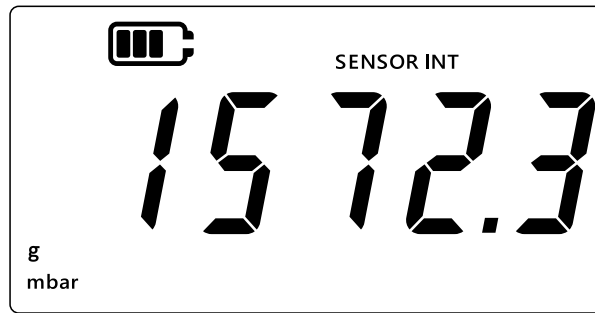

2. Press the , **TARE** and **UNITS** keys simultaneously.
3. The display will show "Rdu" (Advanced) which indicates the Advanced Settings option is selected.

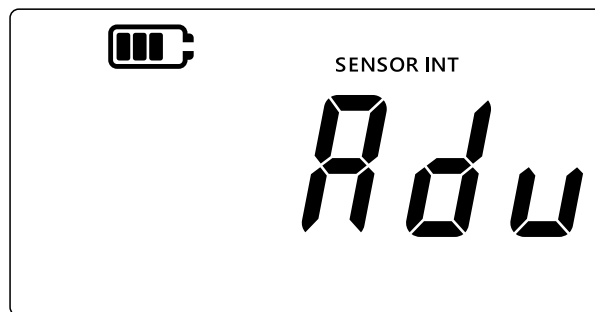

4. Press the  key to enter **Advanced Settings**.
5. A 4-digit PIN is prompted for.

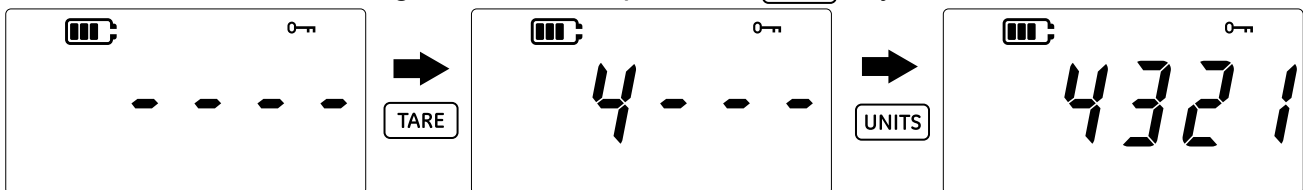

3.1.1.1 To Enter User PIN

- a. Press the **TARE** key to increment the current digit value 0-9.
- b. Press the **UNITS** key to move to the next digit.
- c. When the fourth digit has been set press the  key to submit the PIN value.

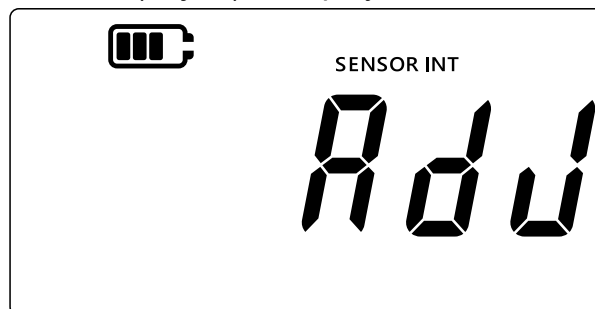

- d. If the PIN is correct "Rdu" (Adjust) is displayed on the screen as shown below.



- e. If the PIN is incorrect, or if  key is pressed without entering all 4 digits, "Err.01" (Error 01) is displayed as shown below. Press the  key to return to the previous screen and re-enter the correct PIN.

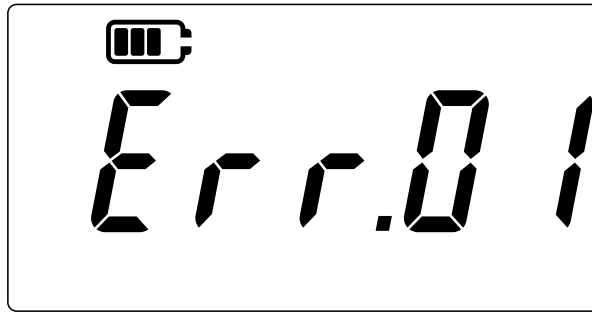

3.1.2 Calibrate Sensor

This feature adjusts the calibration of the internal or external sensor. The same procedure is used for the internal and external sensor. The display shows "SENSOR INT" (Internal Sensor) when calibrating the internal sensor and "EXT SENSOR" (External Sensor) for the external sensor.

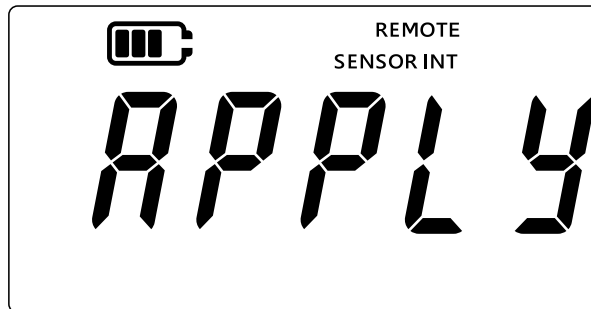

1. From the "Adj" (Adjust) screen, press the  key to proceed to the sensor calibration screen.
2. The display will show "APPLY" (Apply).

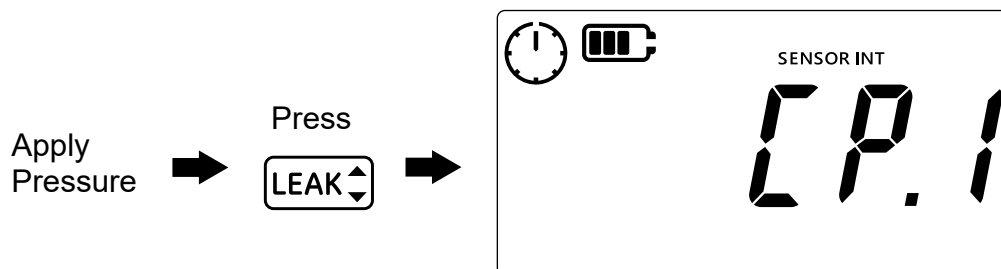

3. Apply a known pressure (or resistance for RTD) from a calibrated source, wait for the reading to be stable.
4. Once the required pressure/resistance is reached, press the  key. This will bring up the **Calibration Point 1** screen indicated by "CP.1" (Calibration Point 1) on the display as shown below.





Note: The clock symbol will rotate which indicates that the pressure readings are being averaged to give a more stable pressure value. The clock will average the readings for 5 seconds.

5. Once the clock symbol stops rotating and disappears, press the  key.
6. Enter the pressure/resistance value applied. Use the  key to increment the current digit value, and the  key to move to the next digit.

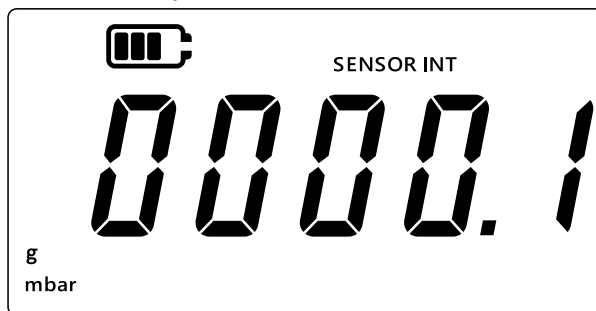



The image below shows an example where “0000.1” mbar is entered as Calibration Point 1.



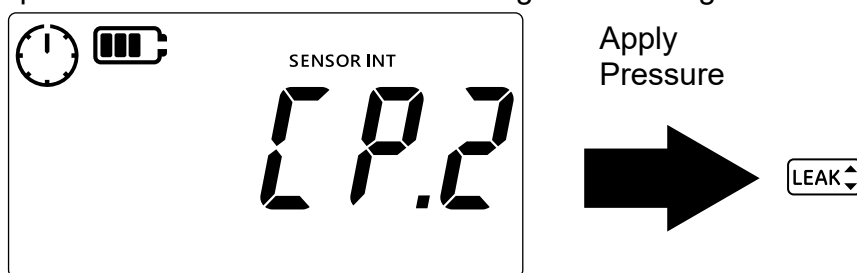



7. Press the  key to save the value.
8. The unit will display the “*APPLY*” (Apply) text again for the next calibration point value as “*CP2*” (Calibration Point 2). Apply a known pressure/resistance from a calibrated source, wait for the value to be stable.
9. Once the required pressure/resistance is reached, press the  key. This will bring up **Calibration Point 2** screen indicated by “*CP2*” (Calibration Point 2) on the display as shown below.

The clock symbol rotates which indicates that the readings are being averaged to give a more stable pressure value. The clock will average the readings for 5 seconds.

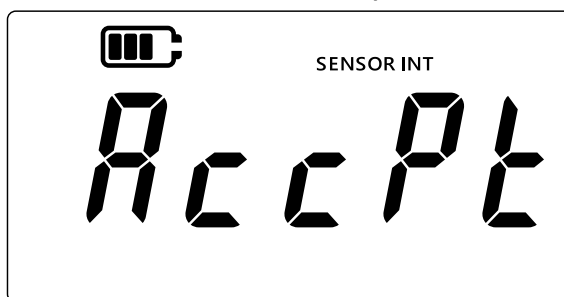

10. Once the clock symbol stops rotating and disappears, press the  key.
11. Enter the pressure/resistance value applied. Use the  key to increment the current digit value, and the  key to move to the next digit.
12. Press the  key to save the value.
13. The unit will display “*ACCEPT*” (Accept) as shown below to offer the user the choice to accept and commit to the calibration or cancel the attempt.



14. Press the  key to accept and commit to the calibration, or press the  key to cancel.
15. If the calibration is successfully accepted then the calibration date is automatically updated to the current system date set on the DPI705E.
16. Press the  key again to return to the “*Adv*” (Advanced) screen.
17. Press the  key again to return to the sensor reading screen.





3.1.3 Set Calibration Date

This feature allows the calibration date to be manually set (without performing and saving a calibration). The same procedure is used for the internal and external sensor. The display shows “SENSOR INT” (Internal Sensor) when setting the calibration date of the internal sensor and “EXT SENSOR” (External Sensor) for the external sensor.

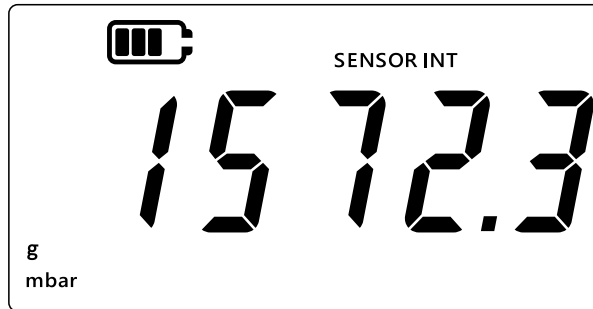



To set the calibration date:

1. Ensure the display is on the sensor reading screen.

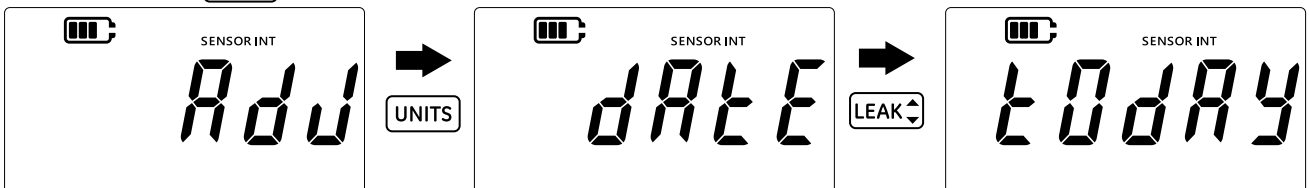

2. Press the ,  and  keys simultaneously.
3. The display will show “*Adv*” (Advanced) which indicates the Settings option is selected.
4. Press the  key to enter Advanced Settings.
5. Enter PIN. The steps to enter PIN are indicated in above Section 3.1.1.1.
6. If the PIN is correct, the display will show “*Adv*” (Adjust).
7. Press the  key to navigate to the “*DATE*” (Date) screen as shown below.



8. Press the  key to set the Last Calibration Date to “*tODAY*” (Today) as shown above. The unit will use the current date saved in the system as the last calibration date of the sensor.
9. To accept this value, press the  key, or press the  key to cancel and leave this screen without setting the calibration date.
10. Press the  key to return to the **Advanced Settings** screen.
11. Press the  key again to return to the sensor reading screen.

3.1.4 Set Calibration Due Interval

This feature allows the calibration interval to be set in days e.g. 365 days (12 months), 180 days (6 months) and so on. The calibration interval determines the next required calibration date of the sensor.

The sensor is supplied with at least 365 days of remaining “in calibration” time, and the default calibration interval is 365 days.







CAUTION The calibration interval is determined by the manufacturers specifications and/or any existing company processes and maintenance policies. Setting an incorrect calibration interval may cause the instrument to be out of calibration leading to incorrect pressure or temperature measurements leading to possible compliance, environmental or health and safety issues.

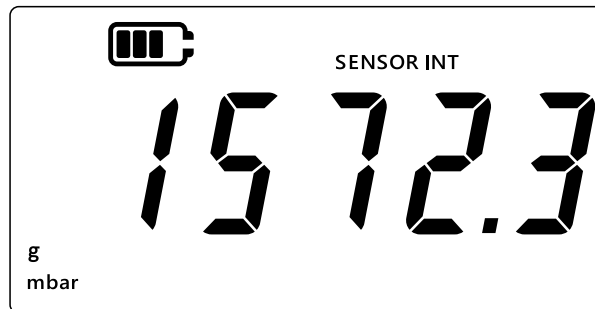





The same procedure is used for the internal and external sensor. The display shows “SENSOR INT” (Internal Sensor) when setting the calibration due interval of the internal sensor and “EXT SENSOR” (External Sensor) for the external sensor.

1. Ensure the display is on the sensor reading screen.



2. Press the ,  and  keys simultaneously.
3. The display will show “*Rdu*” (Advanced) which indicates the Settings option is selected.
4. Press the  key to enter **Advanced Settings**.
5. Enter PIN. The steps to enter PIN are indicated in above Section 3.1.1.1.
6. If the PIN is correct, the display will show “*Rdu*” (Adjust).
7. Press the  key twice to navigate to the “*dUE*” (Due) screen as shown below.



8. Press the  key to enter the calibration interval screen. This will show the current set interval which set to 365 (days) by default. If this has changed previously, it will show the last saved interval value.
9. Enter the interval value in days (between 1 and 540), using the  key to increment the value, and the  key to move to the next digit. Repeat this for all digits.
10. Press the  key to save the entered value.
11. Press the  key to return to the **Advanced Settings** screen.
12. Press the  key again to return to the sensor reading screen.





3.1.5 Change User PIN

This feature allows the default user PIN to be changed.

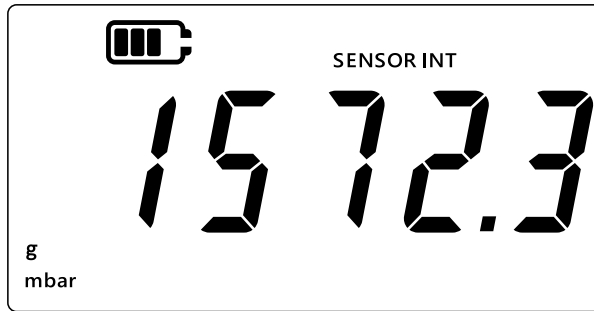

To change user PIN:

1. Ensure the display is on the sensor reading screen.



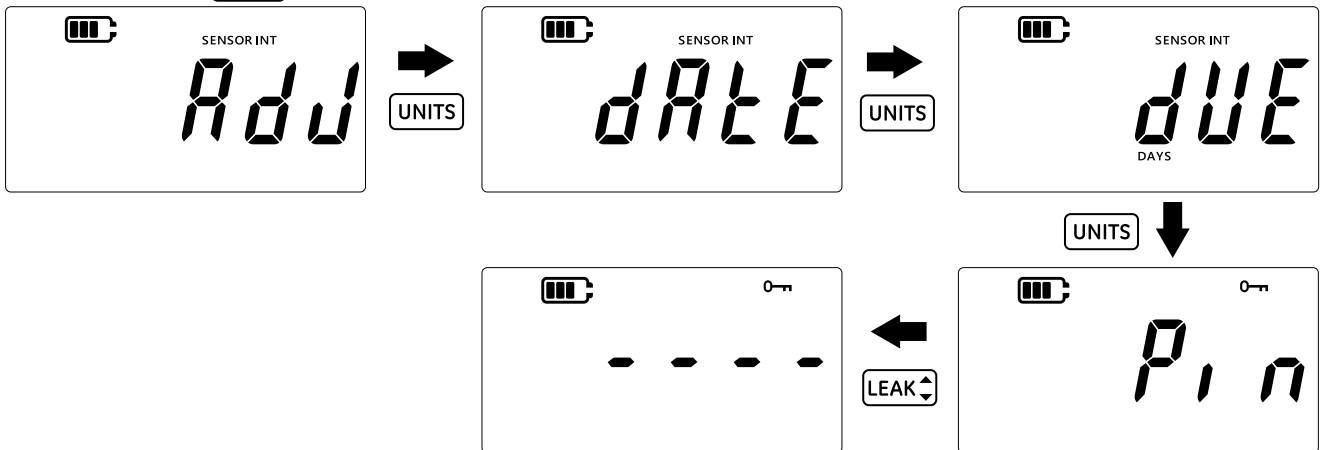



2. Press the ,  and  keys simultaneously.
3. The display will show "Adv" (Advanced) which indicates that the settings option is selected.
4. Press the  key to enter **Advanced Settings**.
5. Enter PIN. The steps to enter PIN are indicated in above Section 3.1.1.1.
6. If the PIN is correct, the display will show "Adv" (Adjust).
7. Press the  key 3 times. to navigate to the "P, n" (PIN) screen as shown below.

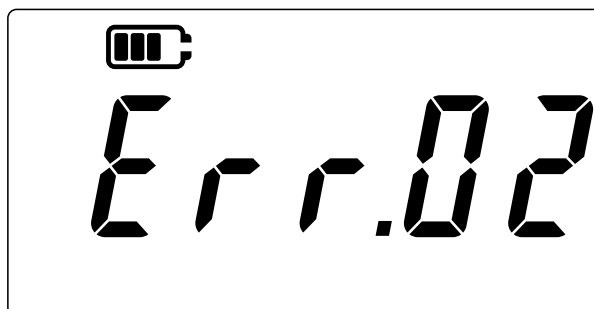

8. Press the  key to navigate to the PIN entry screen as shown above.
9. Enter the new PIN value by using the TARE key to increment the value, UNITS to move to the next digit. Repeat this for all digits.
10. Press the  key to save the entered value.
Note: The PIN must be entered twice.
11. Press the  key again after entering the PIN second time.
12. If the PIN is accepted, the user will be redirected back to the "P, n" (PIN) screen as shown above.

Note: If the PIN values don't match, the error screen shown below will be displayed. Press the  key to re-enter the PIN.







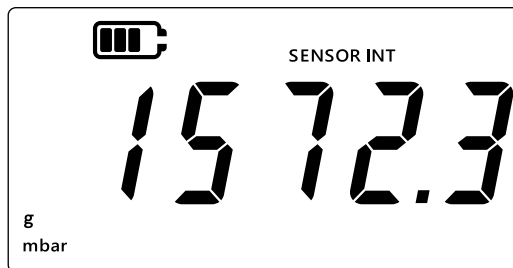

13. At any point in the PIN entry screen press the  key to navigate to the previous screen “P, n” (PIN) without saving the changes.
14. Press the  key to return to the “Adv” (Advanced) screen.
15. Press the  key again to return to the sensor reading screen.

3.1.6 Units Lock

This feature allows certain units that are not required to be disabled. By default, all units are enabled. To disable units or re-enable previously disabled units:

1. Ensure the display is on the sensor reading screen.



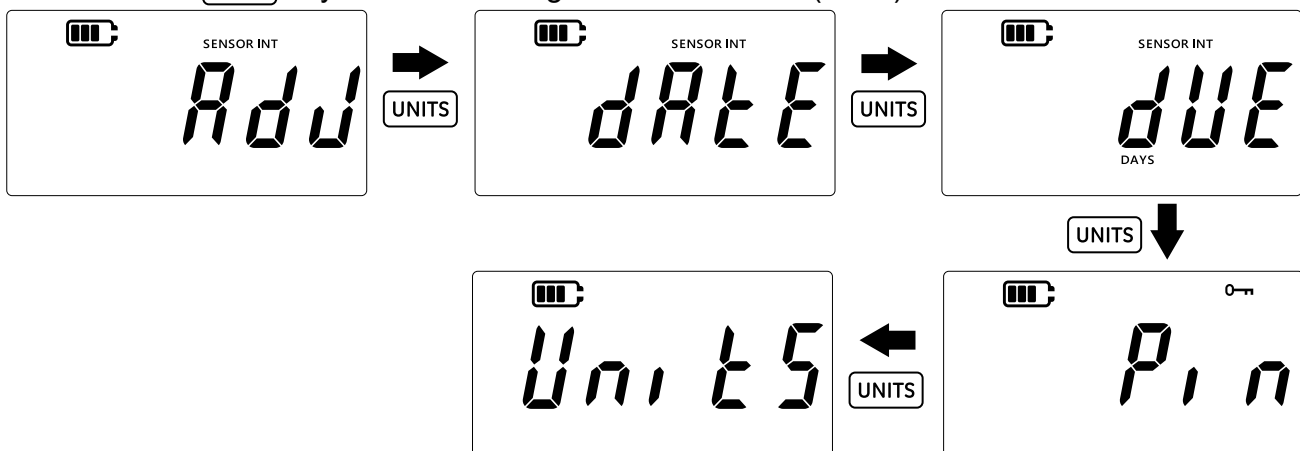

2. Press the ,  and  keys simultaneously.
3. The display will show “Adv” (Advanced) which indicates that the settings option is selected.
4. Press the  key to enter **Advanced Settings**.
5. Enter PIN. The steps to enter PIN are indicated in above Section 3.1.1.1.
6. If the PIN is correct, the display will show “Adv” (Adjust).
7. Press the  key 4 times to navigate to the “Units” (Units) screen as shown below.



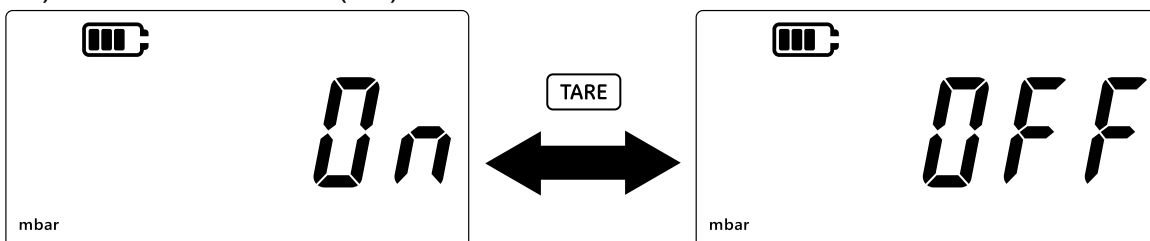

8. Press the  key to enter the Units setting screen.

Note: The screen shows the current measurement unit and indicates its state with text “On” (On) - enabled and “OFF” (Off) - disabled.



9. To disable the unit, press the  key.
10. Press the  key to go to the Next Unit.

11. Finally, once all units are configured, press the  key to save the settings.
12. Press the  key to return to the **Advanced Setting** screen.
13. Press the  key again to return to the sensor reading screen.

3.1.7 Lock Display

This feature allows restricted access to certain features of the instrument.







INFORMATION Enabling the display lock will prevent certain functions from being performed such as changing units, setting the alarm, filter, tare etc.

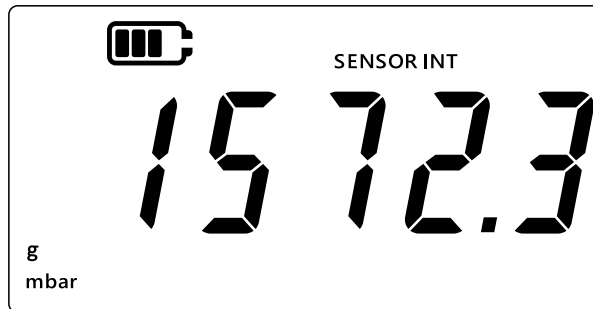

To lock or unlock the instrument display:

1. Ensure the display is on the sensor reading screen.

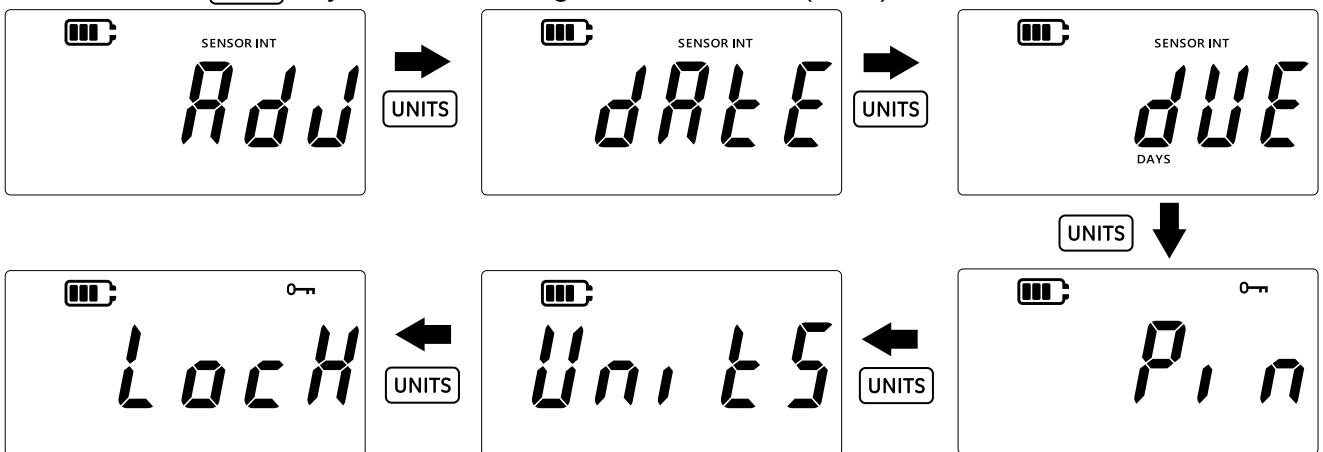

2. Press the ,  and  keys simultaneously.
3. The display will show "Adv" (Advanced) which indicates that the settings option is selected.
4. Press the  key to enter **Advanced Settings**.
5. Enter PIN. The steps to enter PIN are indicated in above Section 3.1.1.1.
6. If the PIN is correct, the display will show "Adj" (Adjust).
7. Press the  key 5 times to navigate to the "Lock" (Lock) screen as shown below.



8. Press the  key to enter the Lock setting screen.
9. The default Lock /Unlock setting will be displayed as "OFF" (Off) which means the lock is disabled.
10. To enable the lock, press the  key. The display will then show "On" (On) which means lock is enabled.

11. To save the setting press the **LEAK** key.

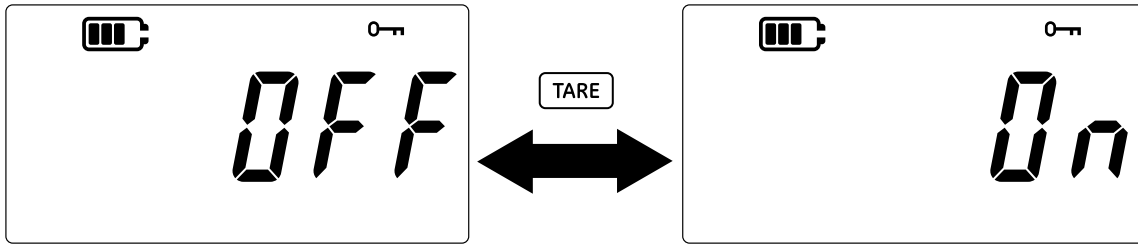

12. Press the **~** key to return to the Advanced Setting screen.

13. Press the **~** key again to return to the sensor reading screen.

3.1.8 Factory Reset

This feature will allow the instrument to be reset to factory settings.

To perform a factory reset:

1. Ensure the display is on the sensor reading screen.

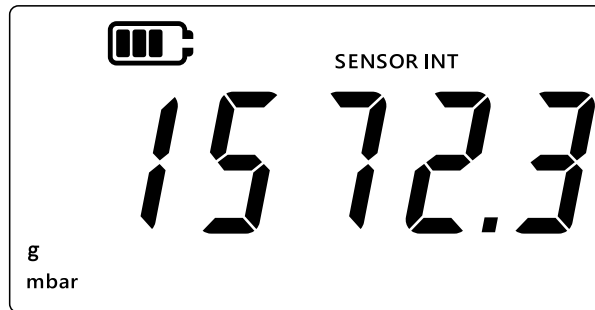

2. Press the **~**, **TARE** and **UNITS** keys simultaneously.

3. The display will show "Rdu" (Advanced) which indicates that the settings option is selected.

4. Press the **LEAK** key to enter **Advanced Settings**.

5. Enter PIN. The steps to enter PIN are indicated in above Section 3.1.1.1.

6. If the PIN is correct, the display will show "Rdu" (Adjust).

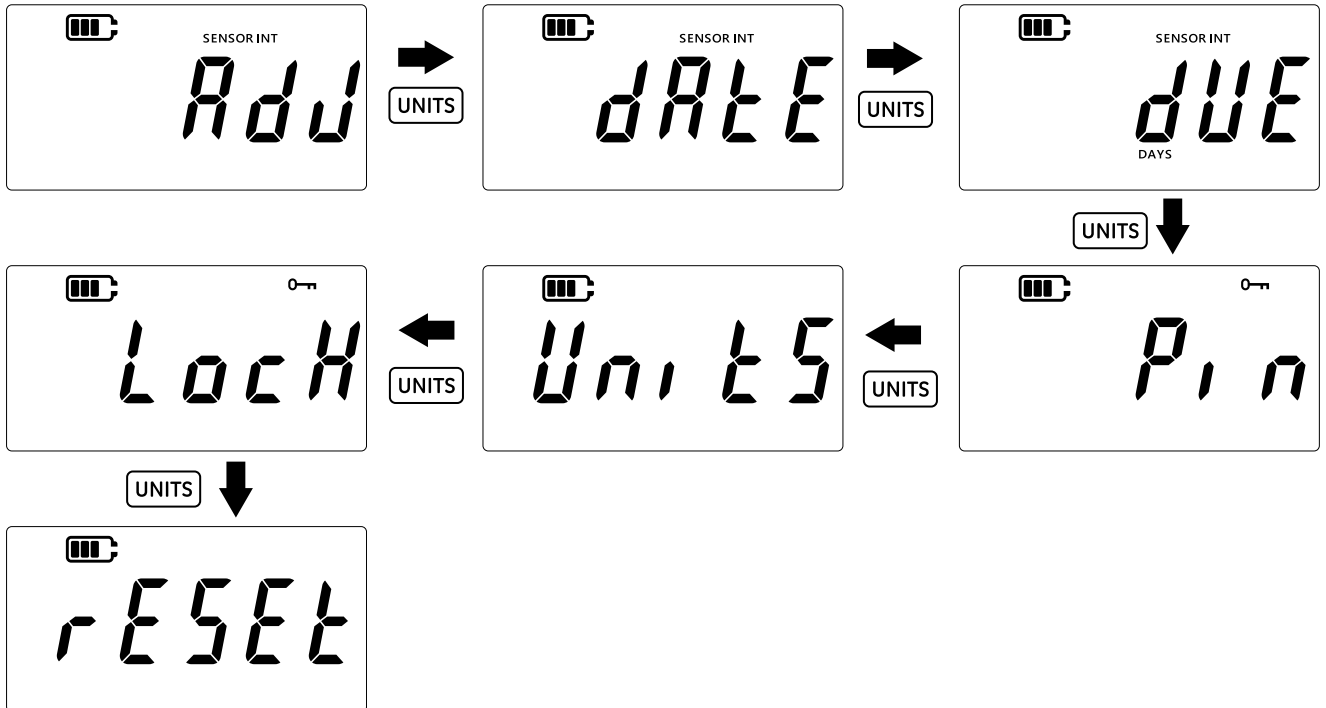

7. Press the **UNITS** key 6 times to navigate to the "rESt" (Reset) screen as shown below.

8. Press the  key to perform factory reset.

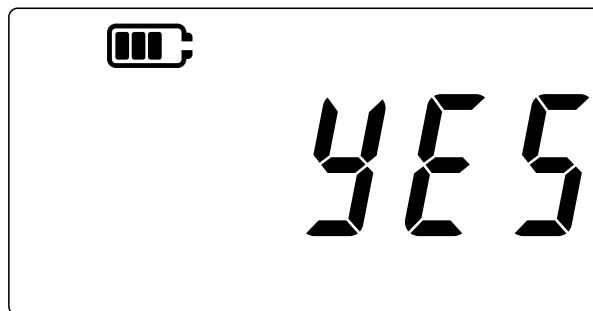

9. The instrument will then show “YE5” (Yes) on the display requesting confirmation of the reset operation.



10. Press the  key again to confirm the factory reset (or press the  key to return to previous screen without resetting).

11. Press the  key to return to the Advanced Settings screen.

12. Press the  key again to return to the sensor reading screen.

3.2 General Settings

The following general settings are available on the DPI 705E:

Setting	Description
Full-scale Value	Displays the full-scale value of the pressure sensor
Calibration Due Date	Displays next calibration date of the sensor
Audio	Turn audio on or off
Auto Shutdown	Enable or disable auto-shutdown
Battery Type	Allows setting the battery type to get maximum usage and accurate capacity readings
Date	Allows setting of system date

Setting	Description
Time	Allows setting of system time
Custom Unit	Allows configuration of a custom scaling factor against predefined units
Software Version	Displays the application software version of the instrument

3.2.1 Full-scale Value

This setting allows the full-scale value of the pressure sensor to be viewed. This is a display only setting, the value cannot be changed.







INFORMATION To display the full-scale value, the appropriate units must be selected. For example, if the full-scale value is 200 bar and mbar units are selected (Full-scale 200,000 mbar), then the full-scale screen will show ‘-----’ because there are insufficient digits to display 200,000.

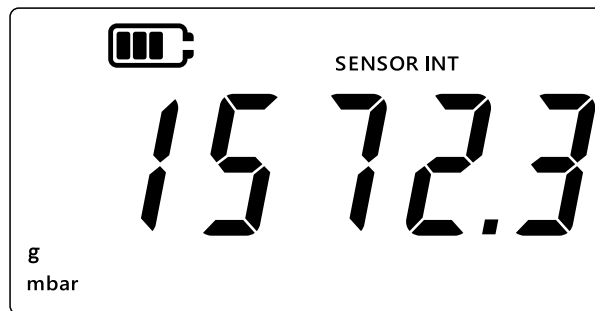



To see the full-scale value:

1. Ensure the display is on the sensor reading screen.

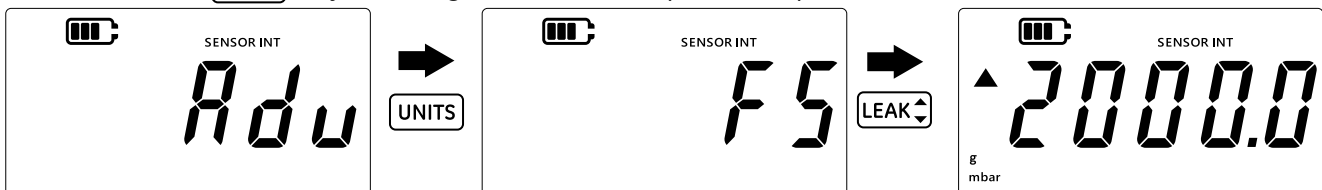

2. Press the ,  and  keys simultaneously.
3. The display will show “*Rdu*” (Advanced) which indicates that the unit is now in the **Settings** option.
4. Press the  key to navigate to the “*F5*” (full-scale) screen as shown below.



5. Press the  key to view the full-scale value.
6. The full-scale value will be shown as seen in above example, 2000 mbar.
7. To exit from this screen either press the  key again or press the  key.
8. Press the  key to return to the sensor reading screen.

3.2.2 Calibration Due Date

The calibration due date is the date when the sensor is next due for calibration.

To see the days until the calibration due date:

1. Ensure the display is on the sensor reading screen.

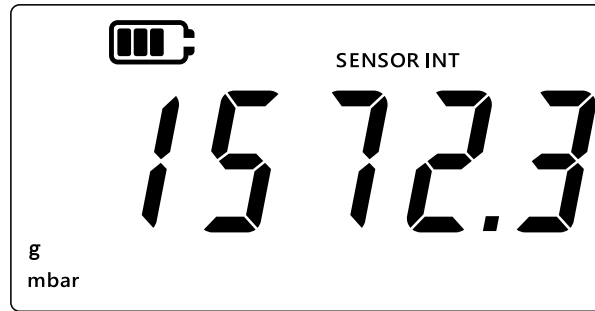

2. Press the , **TARE** and **UNITS** keys simultaneously.
3. The display will show "Adu" (Advanced) which indicates that the unit is now in the **Settings** option.
4. Press the **UNITS** key 2 times to navigate to the **Due Date** screen as shown below.
5. The display will show the days left for calibration as shown below e.g. 154 days.

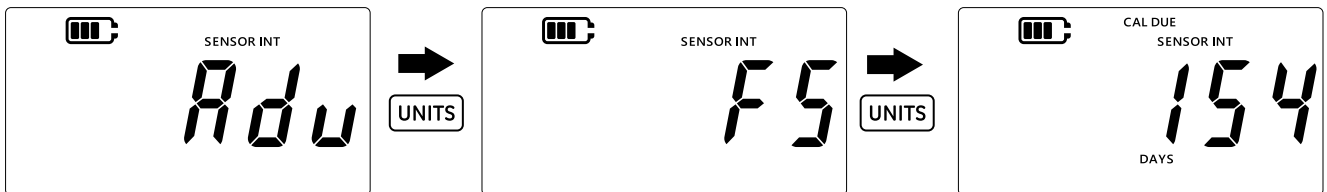

Note: If an external sensor is connected, then the display will show "EXT SENSOR" (External Sensor) and the data for that sensor will be displayed. The calibration information including date is held in each sensor.

6. To navigate out of this screen and return to the sensor reading display press the  key.

3.2.3 Audio

The audio setting allows audio to be switched on or off.

To change audio setting:

1. Ensure the display is on the sensor reading screen.

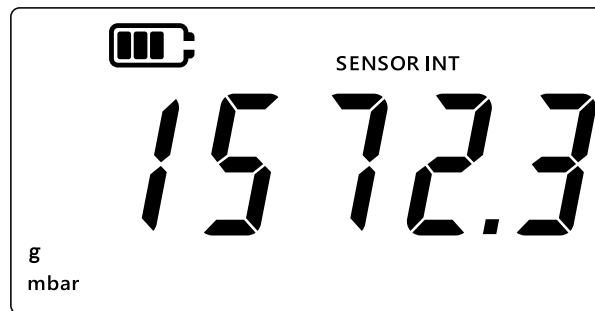

2. Press the , **TARE** and **UNITS** keys simultaneously.
3. The display will show "Adu" (Advanced) which indicates that the unit is now in the **Settings** option.

- Press the **UNITS** key 3 times to navigate to the “*Aud, a*” (Audio) screen as shown below.

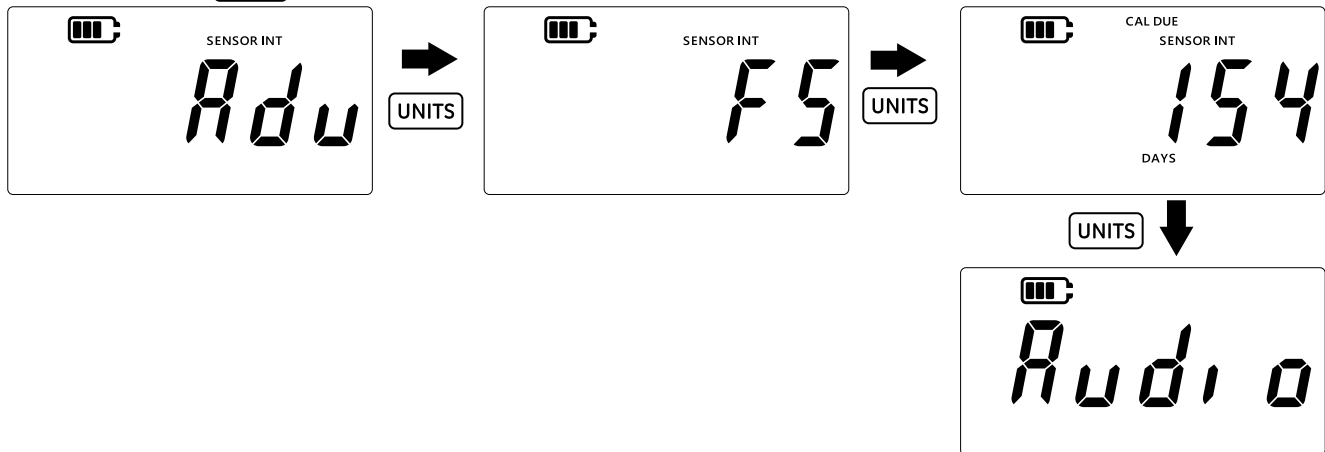

- Press the **LEAK** key to enter the audio setting option.
- The current setting will be displayed as shown below.

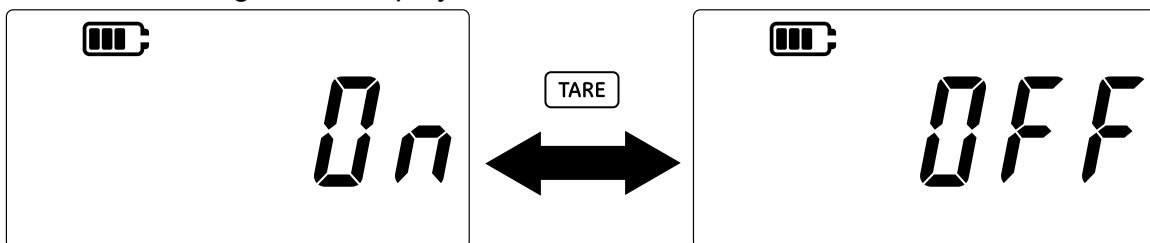

- To toggle the setting press the **TARE** key.
- Press the **LEAK** key to save the setting and return to the previous screen (or press the **≈** key to return without saving).
- Press the **≈** key to return to the sensor reading screen.

3.2.4 Auto shutdown

This feature will allow control of the auto shutdown behavior of the instrument.

By default, the DPI 705E is configured to shut down after 10 minutes of no activity (i.e. no key presses).

To change this setting:

- Ensure the display is on the sensor reading screen.

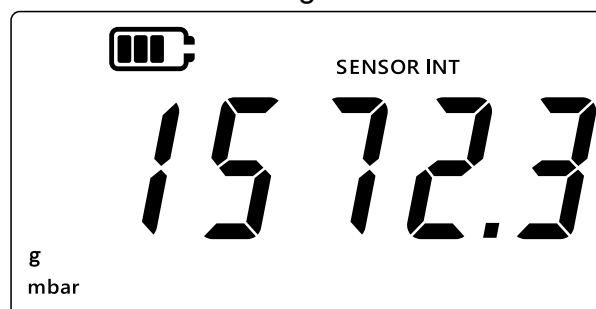

- Press the **≈**, **TARE** and **UNITS** keys simultaneously.
- The display will show “*Adu*” (Advanced) which indicates that the unit is now in the **Settings** option.

4. Press the **UNITS** key 4 times to navigate to the auto shutdown screen. "On.OFF" (On.OFF) will be displayed as shown below.

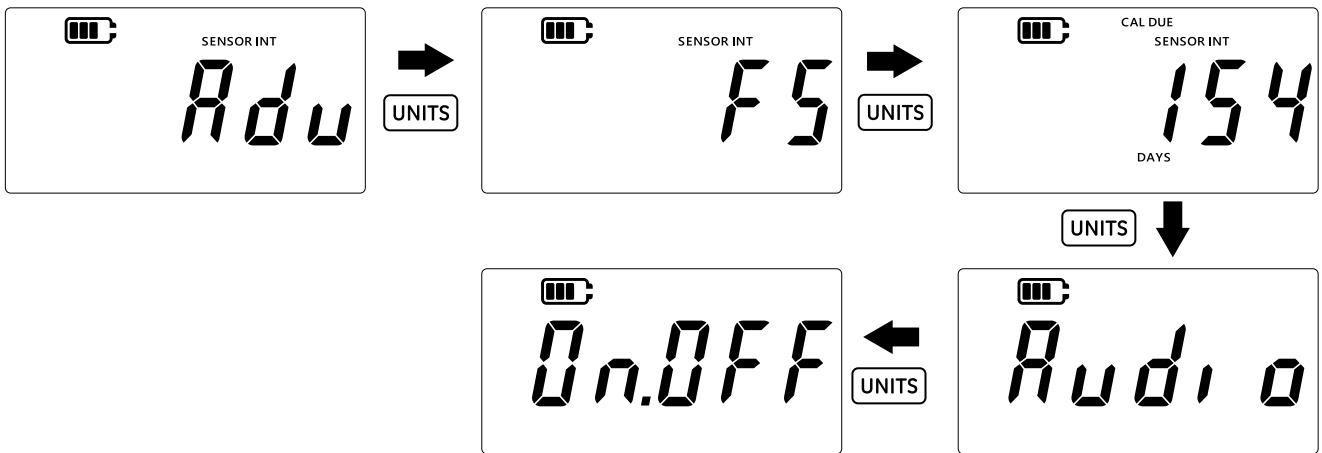

5. Press the **LEAK** key to enter the auto shutdown setting option.
6. The display will then show the default or the last saved auto shutdown value. Default option is "OFF.10" (Off.10) which means 10 minutes timeout on no activity. The second option is "OFF.no" (Off.no) which means the auto shutdown will be disabled.

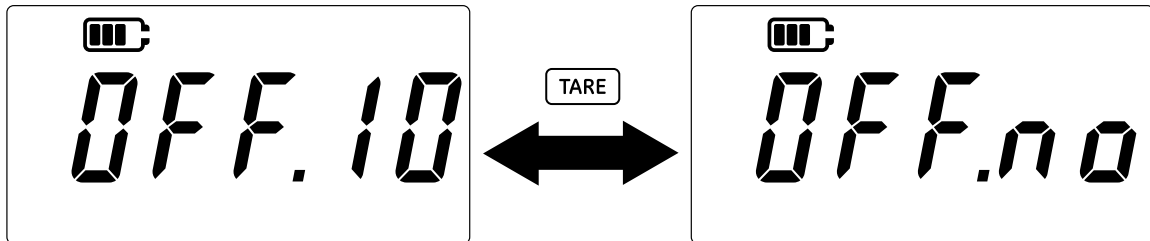

7. To toggle the options, press the **TARE** key.
8. To accept the value and return to the previous screen, press the **LEAK** key.
9. To leave the screen without saving, press the **≈** key.
10. Press the **≈** key to return to the sensor reading screen.

3.2.5 Battery Type

The battery type setting allows configuration of the fitted battery type to get maximum battery life and get accurate capacity readings.

The DPI 705E supports four battery types:

- Alkaline (Al)
- Lithium (LiFeS)
- Nickel Cadmium (Ni-Cd)
- Nickel Metal Hydride (Ni-MH).



The latter two are both Nickel based chemistry and have a single setting type "bAt.n I" (Battery.Nickel).

Note: The Intrinsically Safe DPI 705E-IS can only be used with the first two battery technologies listed (Al and LiFeS) - refer to safety manual.

To change the battery type:

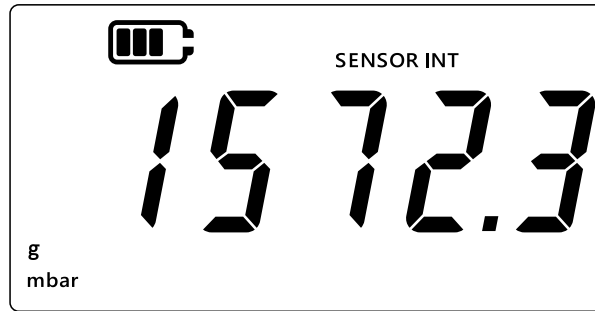
1. Ensure the display is on the sensor reading screen.



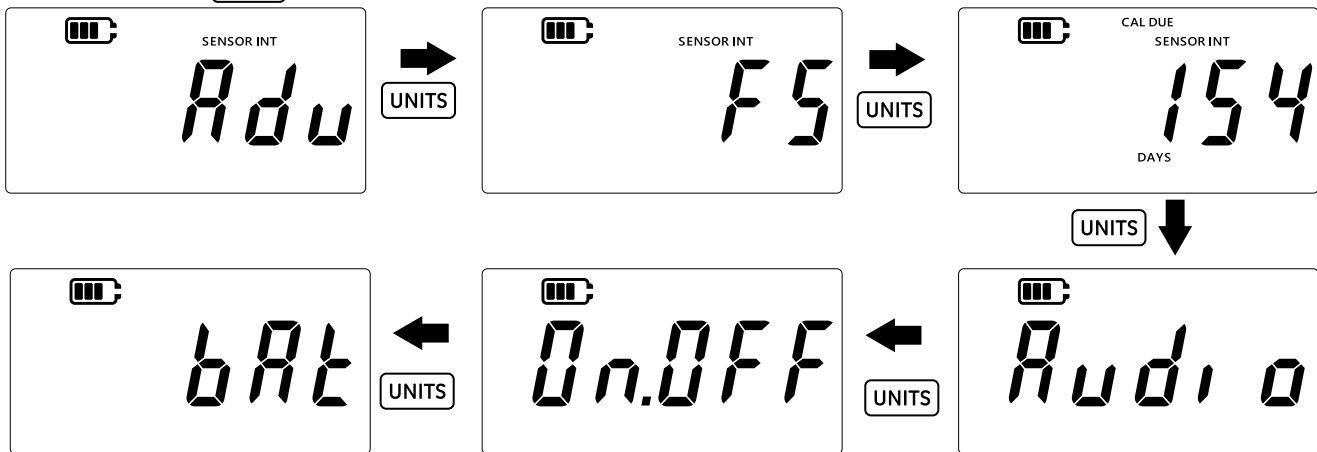

2. Press the , **TARE** and **UNITS** keys simultaneously.
3. The display will show “*Rdu*” (Advanced) which indicates that the unit is now in the **Settings** option.
4. Press the **UNITS** key 5 times to navigate to the “*bAt*” (Battery) screen as shown below.
5. Press the  key to enter the battery type setting option.

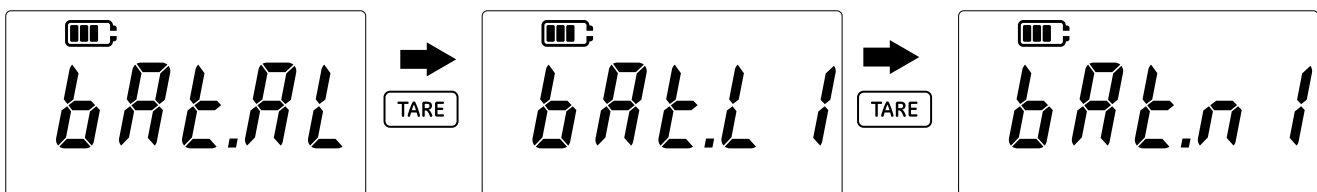

6. The default battery type is Alkaline displayed as “*bAt.AL*” (Battery.Alkaline) shown below.
7. To change the battery type press the **TARE** key. This will show the next battery type indicated by “*bAt.n l*” (Battery.Nickel) for Nickel Metal Hydride or “*bAt.L l*” (Battery.Lithium) for Lithium.



8. Press the  key to save the desired battery type and return to the previous screen.
9. Press the  key to leave the screen without saving the changes.
10. Press the  key to return to the sensor reading screen.

3.2.6 Date

This setting changes the system date.

To change the date:

1. Ensure the display is on the sensor reading screen.

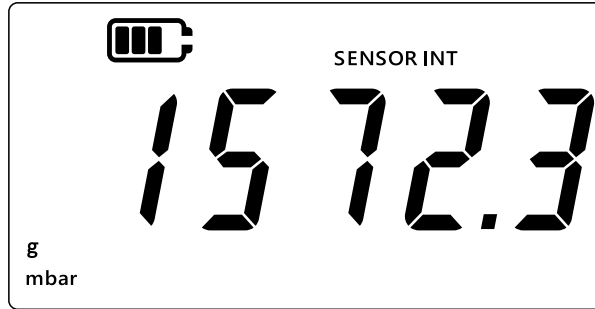

2. Press the , **TARE** and **UNITS** keys simultaneously.
3. The display will show "Adu" (Advanced) which indicates that the unit is now in the **Settings** option.
4. Press the **UNITS** key 6 times to navigate to the "dAtE" (Date) screen as shown below.

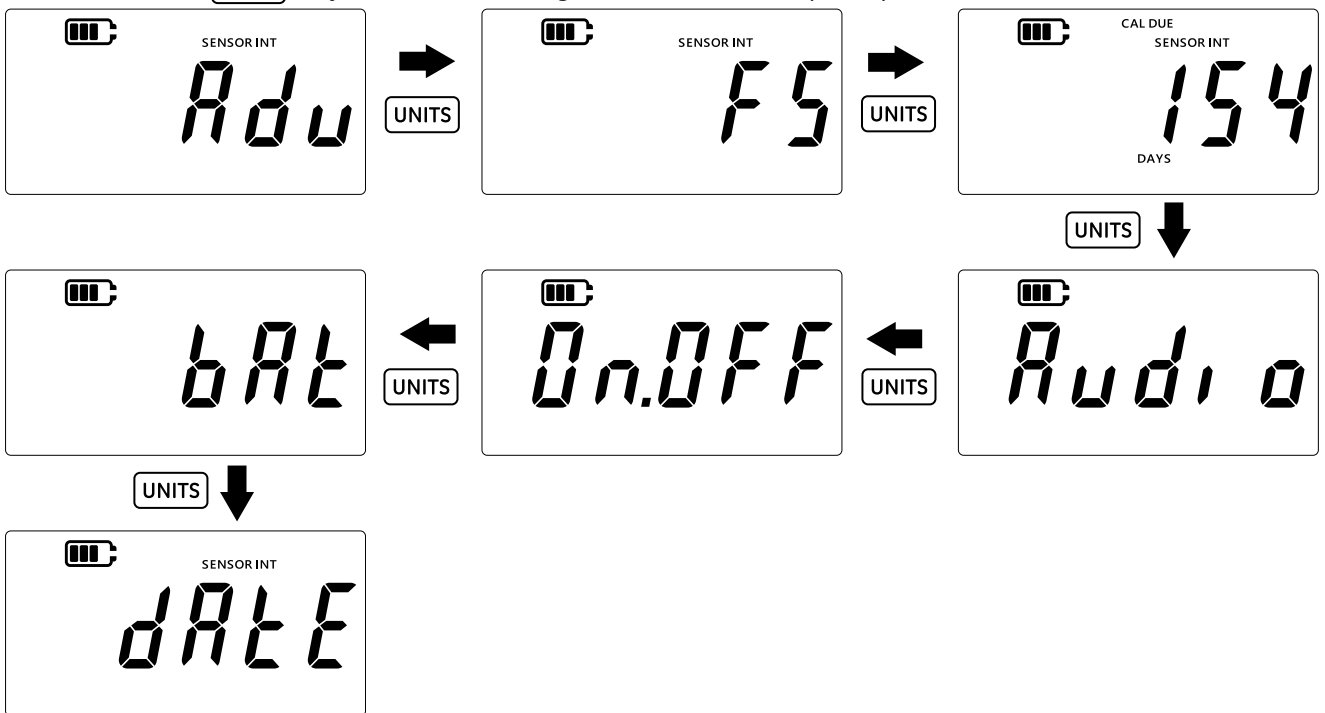

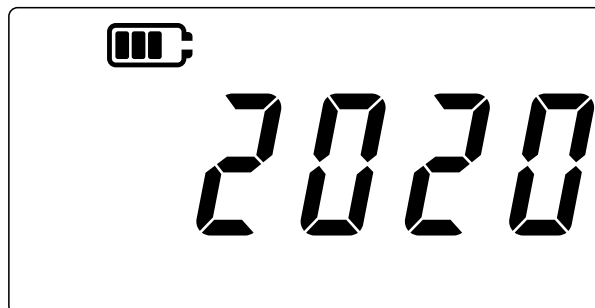

5. Press the **LEAK**  key to enter the date setup.
6. The year value is displayed as shown below.







7. To change the year value, press the **TARE** key to increment the current (flashing) digit, and the **UNITS** key to move to the next digit.

Note: Only the last 2 digits of the year can be changed.

8. Press the  key to save the changes and move on to the next screen (or press the  key to return to the previous screen without saving).
9. The next screen will show the Date / Month values as “DD.MM” as shown below, e.g. “30.01”.



10. To change the date / month value, press the  key to increment the current (flashing) digit, and the  key to move to the next digit.
11. Press the  key to save the changes and return to the settings menu (or press the  key to return without saving).
12. Press the  key to return to the sensor reading screen.



3.2.7 Time

This setting changes the system time. The main purpose of the time setting is to allow the date to rollover at the correct time (i.e. midnight).

To change the time:

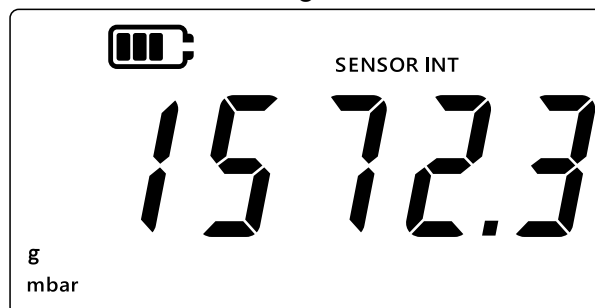
1. Ensure the display is on the sensor reading screen.



2. Press the ,  and  keys simultaneously.
3. The display will show “*Rdu*” (Advanced) which indicates that the unit is now in the **Settings** option.

4. Press the **UNITS** key 7 times to navigate to the “Clock” screen as shown below.

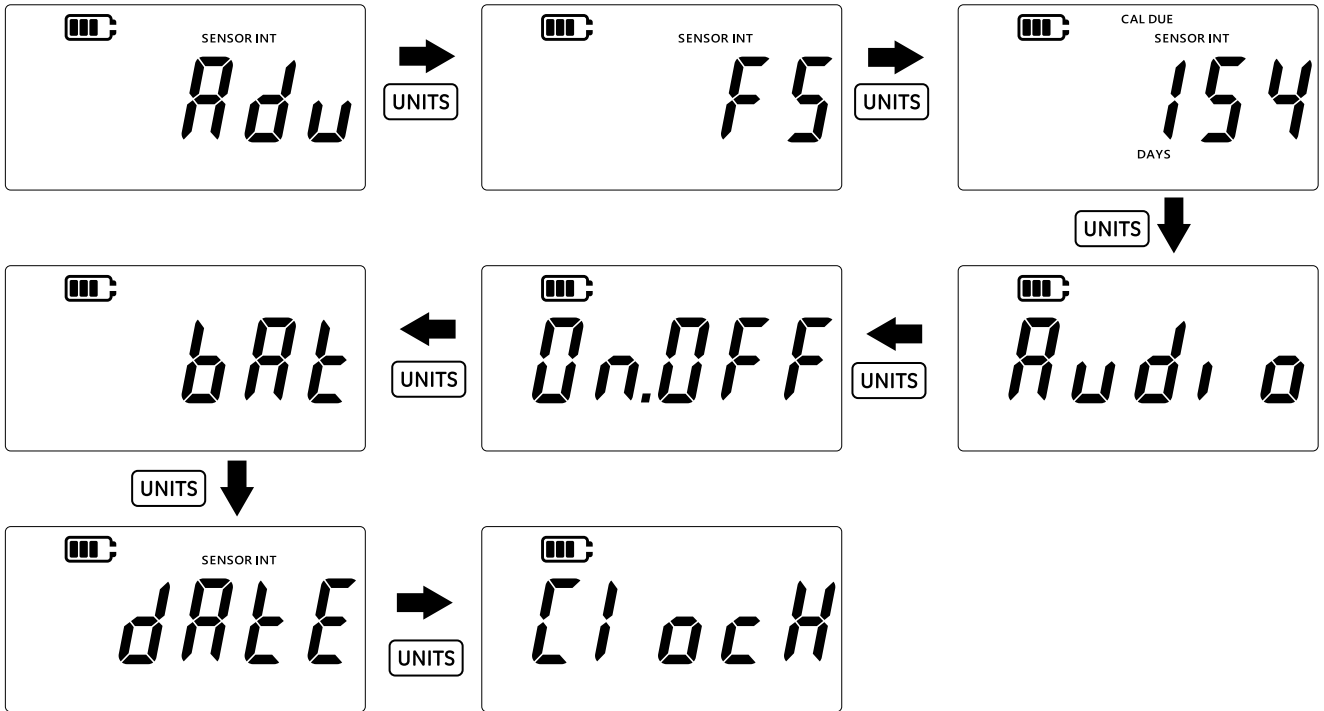

5. Press the **LEAK** key to enter the clock setting option.

6. The current set time is displayed in a “hh.mm” format as shown below. 24-hour format is used.

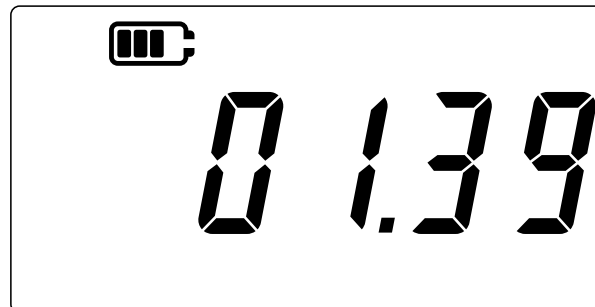

7. To change the time value, press the **TARE** key to increment the current (flashing) digit, and the **UNITS** key to move to the next digit.

8. Press the **LEAK** key to save the changes and return to the previous screen (or press the **≈** key to return without saving).

9. Press the **≈** key to return to the sensor reading screen.

3.2.8 Custom Unit

This setting allows a scaling factor (conversion factor) to be set for the pressure measurement and this will be saved as a Custom Unit. The scaling factor set will be applied automatically for all existing units in the instrument. The scaling factor will only be applied when the custom unit is selected during pressure measurement.

To set a custom scaling factor:

1. Ensure the display is on the sensor reading screen.

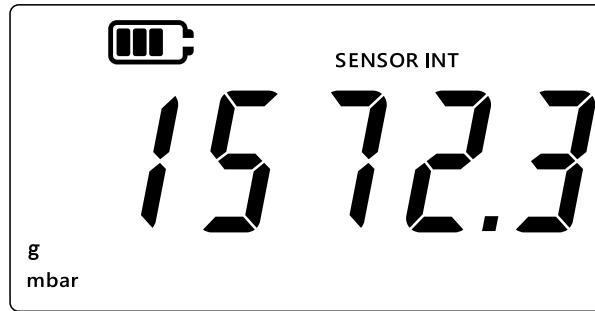

2. Press the , **TARE** and **UNITS** keys simultaneously.
3. The display will show "Adu" (Advanced) which indicates that the unit is now in the **Settings** option.
4. Press the **UNITS** key 8 times to navigate to the "SCALE" (Scale) screen as shown below.

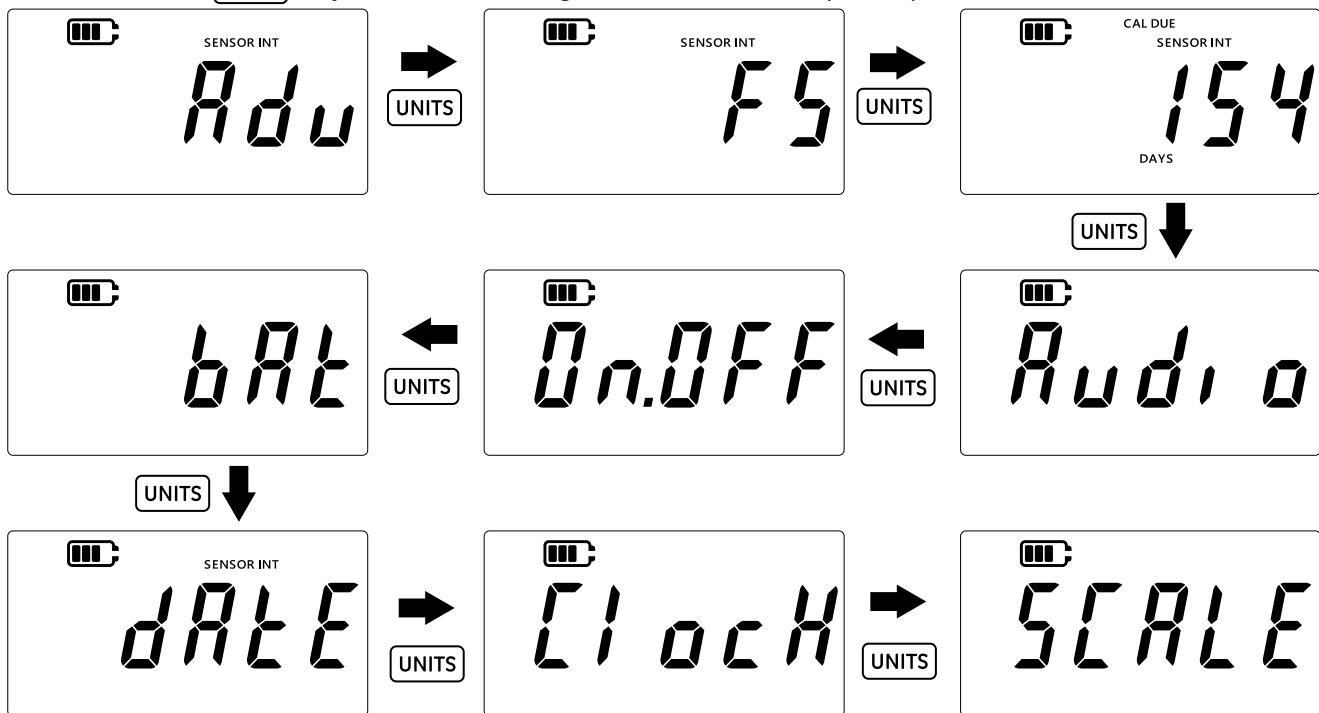

5. Press the  key to enter the custom unit setup.
6. The current unit will be shown by default along with a down arrow: e.g. 1.0000 mbar in screen below.

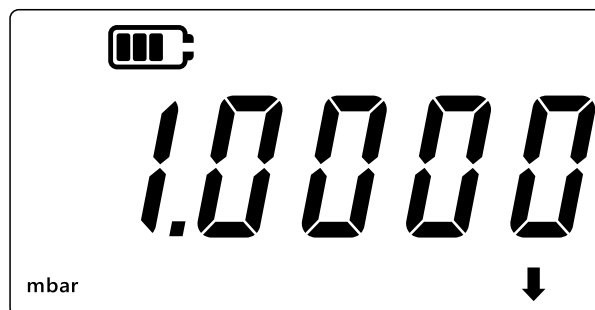

Note:

- The down arrow on the bottom right corner of the display means it is a custom unit.
- The unit starts flashing which means it is the current unit.
- The default scaling factor for whichever unit the device is currently set to is 1.0000

Example: The below screen shows the scale value changed from the default value of 0.0100 to 3.0000 for mbar.

- To set a negative value, press the **LEAK** key until the UP / DOWN arrows flash, then press the **TARE** key to toggle the negative value symbol.
- To move the decimal point, press the **UNITS** key until the decimal point flashes, then press the **TARE** key to move the decimal point to the right one digit at a time. If it is taken too far press the **UNITS** button and repeat the process.
- The scale factor that is set for a unit is automatically applied for all other units. To verify this, press the **TARE** key and navigate to other units. The scale factor values updates. For example, after setting a scale factor of 3.000 for mbar, a scale factor of 0.0030 for bar is shown and so on.

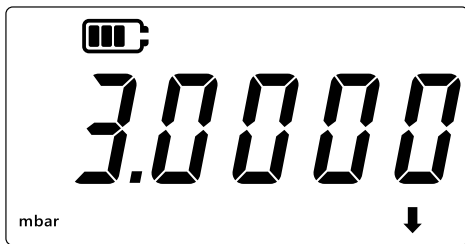

7. Press the **HOME** key to return to the sensor reading screen.
 8. To apply the custom unit to the pressure reading:
 - Navigate to the sensor reading screen as shown in step 1 above.
 - Press the **UNITS** key until a down arrow is visible at the bottom as shown below. The custom unit is now applied.
- Note:** The down arrow means the custom unit is selected.
- The reading which is visible will be scaled to the scale factor that is configured.

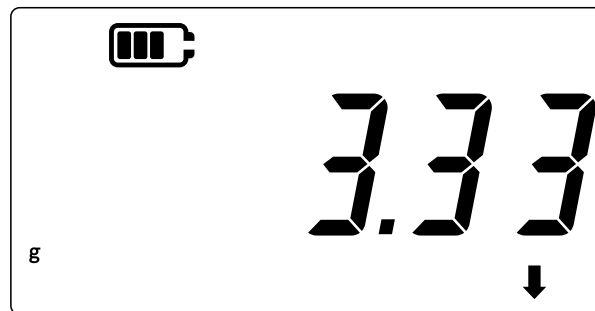



3.2.9 Software Version

This setting shows the application software version on the instrument.

To see the application software version:

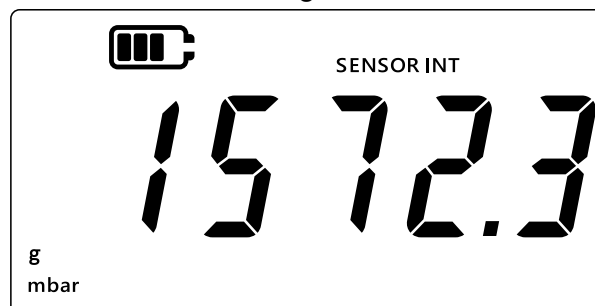
1. Ensure the display is on the sensor reading screen.



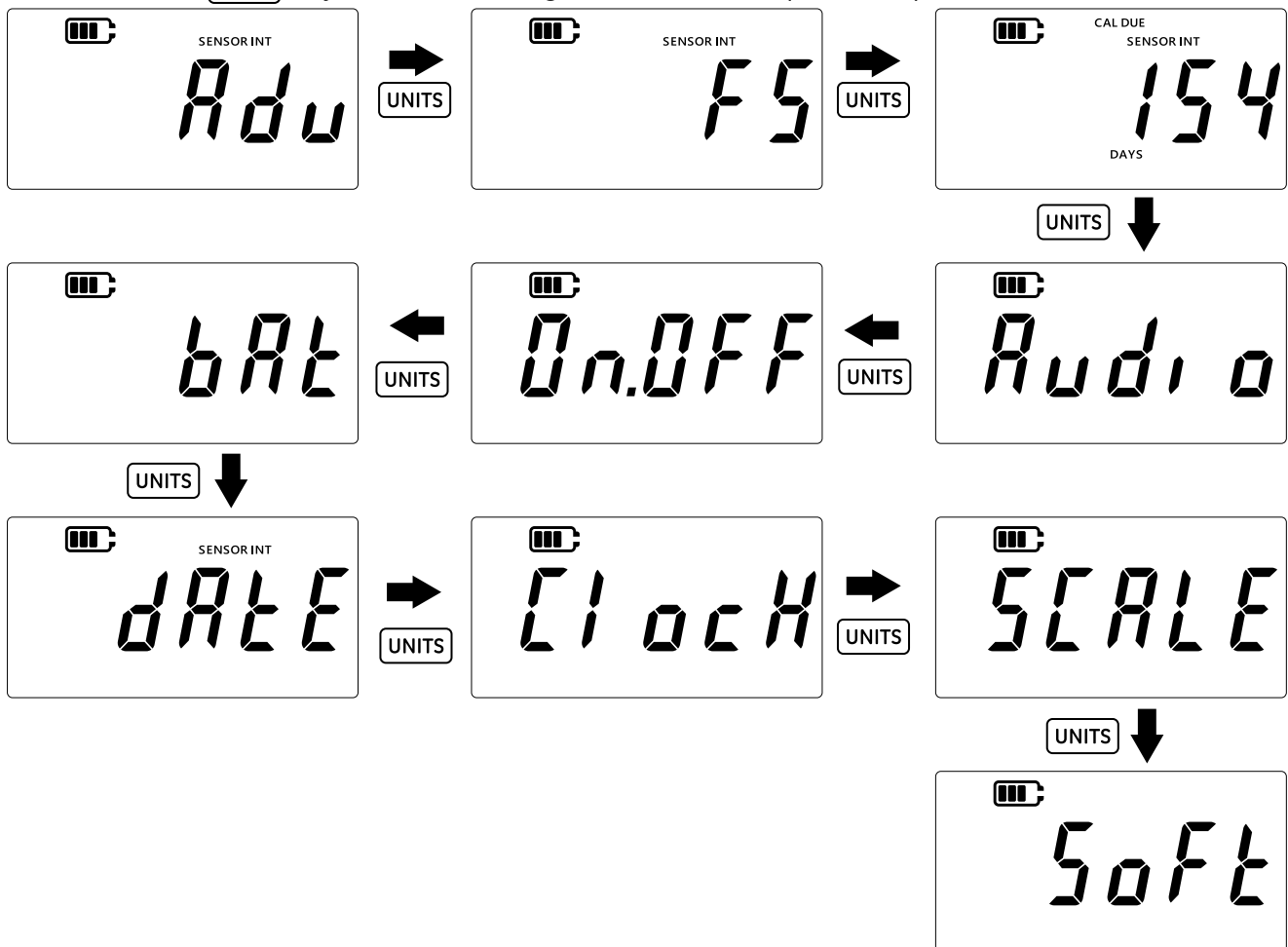

- Press the , **TARE** and **UNITS** keys simultaneously.
- The display will show "Adu" (Advanced) which indicates that the unit is now in the **Settings** option.
- Press the **UNITS** key 9 times to navigate to the "Soft" (Software) screen as shown below.

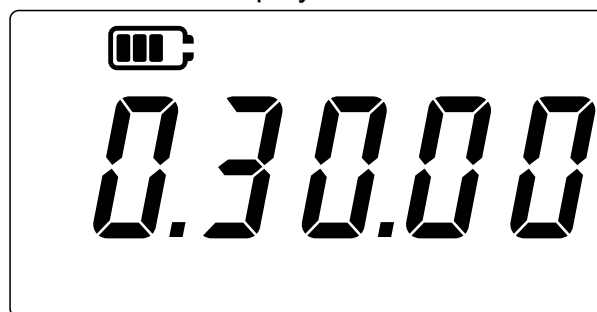

- Press the **LEAK** key to enter the software option.
- The current software version will be displayed as shown below.



- Press the  key to go back to the previous screen.
- Press the  key again to return to the sensor reading screen.















4. Accessories

The DPI 705E / DPI 705E-IS is compatible with the following accessories. All accessories are compatible with either the Intrinsically Safe or Non-Intrinsically Safe versions of the product unless otherwise specified.



Part Code	Description
IO-RTD-M12CON	Field wireable M12 connector 4-pin to fit RTD-INTERFACE
IO-RTD-M12EXT	M12 male to female extension lead 2 m (6.6 ft) 4-wire
IO-RTD-PRB150	150 mm length 6 mm diameter PT100 steel RTD probe Class A
PM700E-CABLE	Remote Sensor Extension Cable 2.9 m (9.5 ft)
IO705E-STRAP	Magnetic Hanging Strap with Loop
IO705E-CASE	Carry Case (for non-Intrinsically Safe DPI 705E Unit)
IO705E-CASE-IS	Carry Case (for Intrinsically Safe DPI 705E-IS Unit)
IO-ADAPT-G1/4	G1/4 female pressure adaptor
IO-ADAPT-1/4NPT	1/4 NPT pressure adaptor
IO-ADAPT-1/8NPT	1/8 NPT pressure adaptor
IO-ADAPT-QF	Quick-fit hose pressure adaptor
IOHOSE-NP1	Nylon hose, 1 m (3.3 ft) length, 20 bar/300 psi MWP
IOHOSE-NP2	Nylon hose, 2 m (6.6 ft) length, 20 bar/300 psi MWP
IO620-HOSE-P1	Pneumatic Hose, 1 m (3.3 ft) length, 100 bar/1500 psi MWP
IO620-HOSE-P2	Pneumatic Hose, 2 m (6.6 ft) length, 100 bar/1500 psi MWP
IO620-HOSE-H1	Hydraulic Hose, 1 m (3.3 ft) length, 1000 bar/15000 psi MWP
IO620-HOSE-H2	Hydraulic Hose, 2 m (6.6 ft) length, 1000 bar/15000 psi MWP
IO620-HOSE-P1-IS	Pneumatic Hose for IS units, 1 m (3.3 ft) length, 100 bar/1500 psi MWP
IO620-HOSE-P2-IS	Pneumatic Hose for IS units, 2 m (6.6 ft) length, 100 bar/1500 psi MWP
IO620-HOSE-H1-IS	Hydraulic Hose for IS units, 1 m (3.3 ft) length, 1000 bar/15000 psi MWP
IO620-HOSE-H2-IS	Hydraulic Hose for IS units, 2 m (6.6 ft) length, 1000 bar/15000 psi MWP
IO620-BSP	5 adaptors AMC Quick connect to G1/4F, G3/8F, G1/2F, G1/4M, G1/8M
IO620-NPT	5 adaptors AMC Quick connect to 1/4NPTF, 3/8NPTF, 1/2NPTF, 1/4NPTM, 1/8NPTM
IO620-MET	2 adaptors AMC Quick Connect to M14F & M20F
IO620-COMP	2-way comparator adaptor AMC Quick connect male to 2 X AMC quick connect Female – for comparing 2 gauges simultaneously

5. Error Codes & Diagnostics

5.1 Error Codes

Error Code	Meaning	Solution/Action
Err.01	Entered PIN is not correct	Press the  (OK) key and enter correct PIN, or press the  (Back) key to exit the function.
Err.02	PIN mismatch during PIN setting – second PIN does not match first PIN	Press the  (OK) key and enter correct PIN, or press the  (Back) key to exit the function.
Err.03	Invalid values entered (e.g calibration attempt beyond sensor range)	Press the  (OK) key and use valid calibration points, or press the  (Back) key to exit the function.
Err.04	User entered value is not valid (e.g date dd.mm = 31.02, or a user scaling factor = 0.0)	Press the  (OK) key and perform valid calibration, or press the  (Back) key to exit the function.
Err.05	Invalid calibration point applied during user calibration	Press the  (OK) key and enter valid data range, or press the  (Back) key to exit the function.
Err.06	User attempt to zero a sensor failed	Press the  (OK) key and enter valid data range, or press the  (Back) key to exit the function.
Err.07	Calibration attempted without valid date set	Set the date/time (this is internally battery-backed)
Err.21 Err.23 Err.24	Remote Sensor Error (pressure or RTD sensor)	Disconnect and reconnect remote sensor – if error persists then sensor is either incompatible type with DPI 705E / DPI 705-IS or is faulty.
Err.40-63	Internal error	Internal fault - return unit to service center.
Err.64	User calibration rejected	Press the  (OK) key or the  (Back) key to return to measurement screen.
Err.80	Critical Software Fault	Power off and back on. If problem persists return unit to service center.

5.2 Diagnostics

Behavior	Reason	Solution/Action
Unit displays “b000” (Boot) at startup	Power button was held for greater than 4s at startup, so unit has entered Bootloader mode (a service operation).	Press the  (Power) key to power down unit and then restart, holding down button for less than 4 seconds.
Unit displays “L 0000” (Low battery) at startup then switches off	Batteries are critically low, unit cannot start.	Replace batteries. If fitting new (unused) batteries does not resolve the issue then the unit may be damaged – contact your Service Centre.
Unit displays nothing at attempted power-up		
Unit beeps continuously for 1 minute and alarm icon flashing	Applied pressure is outside range of sensor (common with < 1 bar (14.5 psi) range absolute sensors)	Use within sensor limits (Full-scale of sensor is displayed on power-up and etched on sensor G1/8 connector)
	Applied pressure is outside user set alarm limits	Turn user alarm limits off or widen limits
Cal Due flashing	Calibration is overdue (i.e days remaining less than zero)	Calibrate unit/sensor
Full-scale reading shows “-----” at power-up	Unable to display sensor full-scale due to unsuitable pressure units being selected (e.g. 1,400 bar (20,000 psi) full-scale sensor with units set to psi)	Change units selected
Unit displays “dRtE” (Date) at startup or Cal Due days indicates as “---”	Real-time clock not set, unit does not know date (and therefore cannot display Cal Due days)	Set date or press the  (Back) key to ignore. Message will repeat every power-up if ignored

6. Approved Service Centers

6.1 Return Goods/Material Procedure

If the unit requires calibration or is unserviceable, return it to the nearest Druck Service Centre listed at:



Druck.com/essential



Do not dispose of this product as household waste. Use an approved organization that collects and/or recycles waste electrical and electronic equipment. For more information, contact one of these:

- Our customer service department: Druck.com/essential
- Your local government office.

Contact the Service Department to obtain a Return Goods/Material Authorization (RGA or RMA). Provide the following information for a RGA or RMA:

- Product (e.g. DPI 705E or RTD-INTERFACE-IS).
- Serial number.
- Details of defect/work to be undertaken.
- Calibration traceability requirements.
- Operating conditions.

Office Locations

Headquarters

Leicester, UK
☎ +44 (0) 116 2317233
✉ gb.sensing.sales@bakerhughes.com

China

Guangzhou
☎ +86 173 1081 7703
✉ dehou.zhang@bakerhughes.com

Germany

Frankfurt
☎ +49 (0) 69-22222-973
✉ sensing.de.cc@bakerhughes.com

Japan

Tokyo
☎ +81 3 6890 4538
✉ gesitj@bakerhughes.com

UAE

Abu Dhabi
☎ +971 528007351
✉ suhel.aboobacker@bakerhughes.com

Australia

North Sydney
☎ 1300 171 502
✉ custcare.au@bakerhughes.com

China

Shanghai
☎ +86 135 6492 6586
✉ hensen.zhang@bakerhughes.com

India

Bangalore
☎ +91 9986024426
✉ aneesh.madhav@bakerhughes.com

Netherlands

Hoewelaken
☎ +31 334678950
✉ nl.sensing.sales@bakerhughes.com

USA

Boston
☎ 1-800-833-9438
✉ custcareboston@bakerhughes.com

China

Beijing
☎ +86 180 1929 3751
✉ fan.kai@bakerhughes.com

France

Toulouse
☎ +33 562 888 250
✉ sensing.FR.cc@bakerhughes.com

Italy

Milan
☎ +39 02 36 04 28 42
✉ csd.italia@bakerhughes.com

Russia

Moscow
☎ +7 915 3161487
✉ aleksey.khamov@bakerhughes.com

Services and Support Locations

Tech Support

Global
✉ drucktechsupport@bakerhughes.com

France

Toulouse
☎ +33 562 888 250
✉ sensing.FR.cc@bakerhughes.com

UAE

Abu Dhabi
☎ +971 2 4079381
✉ gulfservices@bakerhughes.com

Brazil

Campinas
☎ +55 19 2104 6924, +55 19 97169 1190
✉ cc.sensing.brasil@bakerhughes.com

India

Pune
☎ +91-2135-620421~425
✉ mcindia.inhouseservice@bakerhughes.com

UK

Leicester
☎ +44 (0) 116 2317107
✉ sensing.grobycc@bakerhughes.com

China

Changzhou
☎ +86 400 818 1099
✉ service.mcchina@bakerhughes.com

Japan

Tokyo
☎ +81 3 6894 1838
✉ service.druck.jp@bakerhughes.com

USA

Billerica
☎ +1 (281) 542-3650
✉ namservice@bakerhughes.com