



Handheld Thermography Camera HIKMICRO Pocket Series

User Manual

Legal Information

Read all information and instructions in this document carefully before using the device and keep it for further reference.

For more device information and instructions, please visit our website at <http://www.hikmicrotech.com>. You can also refer to other documents (if any) accompanying the device to get more information.

About this Manual

The Manual includes instructions for using and managing the Product. Pictures, charts, images and all other information hereinafter are for description and explanation only. The information contained in the Manual is subject to change, without notice, due to firmware updates or other reasons. Please find the latest version of this Manual at the HIKMICRO website (<http://www.hikmicrotech.com>). Please use this Manual with the guidance and assistance of professionals trained in supporting the Product.

©2023 Hangzhou Microimage Software Co., Ltd. All rights reserved.

Trademarks

 **HIKMICRO** and other HIKMICRO's trademarks and logos are the properties of HIKMICRO in various jurisdictions.

Other trademarks and logos mentioned are the properties of their respective owners.

Disclaimer

TO THE MAXIMUM EXTENT PERMITTED BY APPLICABLE LAW, THIS MANUAL AND THE PRODUCT DESCRIBED, WITH ITS HARDWARE, SOFTWARE AND FIRMWARE, ARE PROVIDED "AS IS" AND "WITH ALL FAULTS AND ERRORS". HIKMICRO MAKES NO WARRANTIES, EXPRESS OR IMPLIED, INCLUDING WITHOUT LIMITATION, MERCHANTABILITY, SATISFACTORY QUALITY, OR FITNESS FOR A PARTICULAR PURPOSE. THE USE OF THE PRODUCT BY YOU IS AT YOUR OWN RISK. IN NO EVENT WILL HIKMICRO BE LIABLE TO YOU FOR ANY SPECIAL, CONSEQUENTIAL, INCIDENTAL, OR INDIRECT DAMAGES, INCLUDING, AMONG OTHERS, DAMAGES FOR LOSS OF BUSINESS PROFITS, BUSINESS INTERRUPTION, OR LOSS OF DATA, CORRUPTION OF SYSTEMS, OR LOSS OF DOCUMENTATION, WHETHER BASED ON BREACH OF

CONTRACT, TORT (INCLUDING NEGLIGENCE), PRODUCT LIABILITY, OR OTHERWISE, IN CONNECTION WITH THE USE OF THE PRODUCT, EVEN IF HIKMICRO HAS BEEN ADVISED OF THE POSSIBILITY OF SUCH DAMAGES OR LOSS.

YOU ACKNOWLEDGE THAT THE NATURE OF THE INTERNET PROVIDES FOR INHERENT SECURITY RISKS, AND HIKMICRO SHALL NOT TAKE ANY RESPONSIBILITIES FOR ABNORMAL OPERATION, PRIVACY LEAKAGE OR OTHER DAMAGES RESULTING FROM CYBER-ATTACK, HACKER ATTACK, VIRUS INFECTION, OR OTHER INTERNET SECURITY RISKS; HOWEVER, HIKMICRO WILL PROVIDE TIMELY TECHNICAL SUPPORT IF REQUIRED.

YOU AGREE TO USE THIS PRODUCT IN COMPLIANCE WITH ALL APPLICABLE LAWS, AND YOU ARE SOLELY RESPONSIBLE FOR ENSURING THAT YOUR USE CONFORMS TO THE APPLICABLE LAW. ESPECIALLY, YOU ARE RESPONSIBLE, FOR USING THIS PRODUCT IN A MANNER THAT DOES NOT INFRINGE ON THE RIGHTS OF THIRD PARTIES, INCLUDING WITHOUT LIMITATION, RIGHTS OF PUBLICITY, INTELLECTUAL PROPERTY RIGHTS, OR DATA PROTECTION AND OTHER PRIVACY RIGHTS. YOU SHALL NOT USE THIS PRODUCT FOR ANY PROHIBITED END-USES, INCLUDING THE DEVELOPMENT OR PRODUCTION OF WEAPONS OF MASS DESTRUCTION, THE DEVELOPMENT OR PRODUCTION OF CHEMICAL OR BIOLOGICAL WEAPONS, ANY ACTIVITIES IN THE CONTEXT RELATED TO ANY NUCLEAR EXPLOSIVE OR UNSAFE NUCLEAR FUEL-CYCLE, OR IN SUPPORT OF HUMAN RIGHTS ABUSES.

IN THE EVENT OF ANY CONFLICTS BETWEEN THIS MANUAL AND THE APPLICABLE LAW, THE LATTER PREVAILS.

Regulatory Information

These clauses apply only to the products bearing the corresponding mark or information.

FCC Information

Note: This product has been tested and found to comply with the limits for a Class B digital device, pursuant to Part 15 of the FCC Rules. These limits are designed to provide reasonable protection against harmful interference in a residential installation. This product generates, uses, and can radiate radio frequency energy and, if not installed and used in accordance with the instructions, may cause harmful interference to radio communications. However, there is no guarantee that interference will not occur in a particular installation. If this product does cause harmful interference to radio or television reception, which can be determined by turning the equipment off and on, the user is encouraged to try to correct the interference by one or more of the following measures:

- Reorient or relocate the receiving antenna.
- Increase the separation between the equipment and receiver.
- Connect the equipment into an outlet on a circuit different from that to which the receiver is connected.
- Consult the dealer or an experienced radio/TV technician for help.

Note: Due to the device size limit, the above statement may not be disclaimed on the device.

EU Conformity Statement



This product and - if applicable - the supplied accessories too are marked with "CE" and comply therefore with the applicable harmonized European standards listed under the Directive 2014/30/EU (EMCD), Directive 2014/35/EU (LVD), Directive 2011/65/EU (RoHS).



This product and - if applicable - the supplied accessories too are marked with "UKCA" and comply therefore with the following directives: Radio Equipment Regulations 2017, Electromagnetic Compatibility Regulations 2016, Electrical Equipment (Safety) Regulations 2016, the Restriction of the Use of Certain Hazardous Substances in Electrical and Electronic Equipment Regulations 2012.

Restrictions in the 5 GHz band:

According to Article 10 (10) of Directive 2014/53/EU, when operating in the 5150 to 5350 MHz frequency range, this device is restricted to indoor use in: Austria (AT), Belgium (BE), Bulgaria (BG), Croatia (HR), Cyprus (CY), the Czech Republic (CZ), Denmark (DK), Estonia (EE), Finland (FI), France (FR), Germany (DE), Greece (EL), Hungary (HU), Iceland (IS), Ireland (IE), Italy (IT), Latvia (LV), Liechtenstein (LI), Lithuania (LT), Luxembourg (LU), Malta (MT), Netherlands (NL), Northern Ireland (UK(NI)), Norway (NO), Poland (PL), Portugal (PT), Romania (RO), Slovakia (SK), Slovenia (SI), Spain (ES), Sweden (SE), Switzerland (CH), and Turkey (TR).

In accordance with the Radio Equipment Regulations 2017 in the UK, the device working in the 5150 to 5350 MHz frequency range is restricted to indoor use in the United Kingdom.

Frequency Bands and Power (for CE/UKCA)

The frequency bands and modes and transmitting power (radiated and/or conducted) nominal limits applicable to the following radio equipment are as follows:

Wi-Fi: 2.4 GHz (2.4 GHz to 2.4835 GHz): 20 dBm; 5 GHz (5.15 GHz to 5.25 GHz): 23 dBm; 5 GHz (5.25 GHz to 5.35 GHz): 23 dBm; 5 GHz (5.47 GHz to 5.725GHz): 23 dBm; 5 GHz (5.725 GHz to 5.85 GHz): 14 dBm

Bluetooth: 2.4 GHz (2.4 GHz to 2.4835 GHz): 20 dBm

Use the power adapter provided by a qualified manufacturer. Refer to the product specification for detailed power requirements.

Use the battery provided by a qualified manufacturer. Refer to the product specification for detailed battery requirements.



Directive 2012/19/EU (WEEE Directive): Products marked with this symbol cannot be disposed of as unsorted municipal waste in the European Union. For proper recycling, return this product to your local supplier upon the purchase of equivalent new equipment, or dispose of it at designated collection points. For more information see: www.recyclethis.info

According to the Waste Electrical and Electronic Equipment Regulations 2013: Products marked with this symbol cannot be disposed of as unsorted municipal waste in the United Kingdom. For proper recycling, return this product to your local supplier upon the purchase of equivalent new equipment, or dispose of it at designated collection points. For more information see: www.recyclethis.info.



Directive 2006/66/EC and its amendment 2013/56/EU (Battery Directive): This product contains a battery that cannot be disposed of as unsorted municipal waste in the European Union. See the product documentation for specific battery information. The battery is marked with this symbol, which may include lettering to indicate cadmium (Cd), lead (Pb), or mercury (Hg). For proper recycling, return the battery to your supplier or to a designated collection point. For more information see: www.recyclethis.info

According to the Batteries and Accumulators (Placing on the Market) Regulations 2008 and the Waste Batteries and Accumulators Regulations 2009: This product contains a battery that cannot be disposed of as unsorted municipal waste in the United Kingdom. See the product documentation for specific battery information. The battery is marked with this symbol, which may include lettering to indicate cadmium (Cd), lead (Pb), or mercury (Hg). For proper recycling, return the battery to your supplier or to a designated collection point. For more information see: www.recyclethis.info.

Industry Canada ICES-003 Compliance

This device meets the CAN ICES-003 (B)/NMB-003 (B) standards requirements.

This device complies with Industry Canada licence-exempt RSS standard(s).

Operation is subject to the following two conditions:

- (1) this device may not cause interference, and
- (2) this device must accept any interference, including interference that may cause

undesired operation of the device.

Le présent appareil est conforme aux CNR d'Industrie Canada applicables aux appareils radioexempts de licence. L'exploitation est autorisée aux deux conditions suivantes:

- (1) l'appareil ne doit pas produire de brouillage, et
- (2) l'utilisateur de l'appareil doit accepter tout brouillage radioélectrique subi, même si le brouillage est susceptible d'en compromettre le fonctionnement.

This equipment complies with IC RSS-102 radiation exposure limits set forth for an uncontrolled environment.

ce matériel est conforme aux limites de dose d'exposition aux rayonnements, CNR-102 énoncée dans un autre environnement.

- (i) The device for operation in the band 5150-5250 MHz is only for indoor use to reduce the potential for harmful interference to co-channel mobile satellite systems;
- (ii) The maximum antenna gain permitted for devices in the bands 5250-5350 MHz and 5470-5725 MHz shall comply with the e.i.r.p. limit; and
- (iii) The maximum antenna gain permitted for devices in the band 5725-5825 MHz shall comply with the e.i.r.p. limits specified for point-to-point and non point-to-point operation as appropriate.

- (i) Les dispositifs fonctionnant dans la bande 5150-5250 MHz sont réservés uniquement pour une utilisation à l'intérieur afin de réduire les risques de brouillage préjudiciable aux systèmes de satellites mobiles utilisant les mêmes canaux.
- (ii) Le gain d'antenne maximal autorisé pour les appareils dans les bandes 5250-5350 MHz et 5470-5725 MHz doivent respecter le pire limiter; et
- (iii) Le gain d'antenne maximal autorisé pour les appareils dans la bande 5725-5825 MHz doivent respecter le pire limites spécifiées pour le point-à-point et l'exploitation non point à point, le cas échéant.

KC

B급 기기: 이 기기는 가정용(B급) 전자파적합기기로서 주로 가정에서 사용하는 것을 목적으로 하며, 모든 지역에서 사용할 수 있습니다.

INFORMATIONEN FÜR PRIVATE HAUSHALTE

1. Getrennte Erfassung von Altgeräten:

Elektro- und Elektronikgeräte, die zu Abfall geworden sind, werden als Altgeräte bezeichnet. Besitzer von Altgeräten haben diese einer vom unsortierten Siedlungsabfall getrennten Erfassung zuzuführen. Altgeräte gehören insbesondere nicht in den Hausmüll, sondern in spezielle Sammel- und Rückgabesysteme.

2. Batterien und Akkus sowie Lampen:

Besitzer von Altgeräten haben Altbatterien und Altakkumulatoren, die nicht vom Altgerät umschlossen sind, die zerstörungsfrei aus dem Altgerät entnommen werden können, im Regelfall vor der Abgabe an einer Erfassungsstelle vom Altgerät zu trennen. Dies gilt nicht, soweit Altgeräte einer Vorbereitung zur Wiederverwendung unter Beteiligung eines öffentlich-rechtlichen Entsorgungsträgers zugeführt werden.

3. Möglichkeiten der Rückgabe von Altgeräten:

Besitzer von Altgeräten aus privaten Haushalten können diese bei den Sammelstellen der öffentlich-rechtlichen Entsorgungsträger oder bei den von Herstellern oder Vertriebern im Sinne des ElektroG eingerichteten Rücknahmestellen unentgeltlich abgeben. Rücknahmepflichtig sind Geschäfte mit einer Verkaufsfläche von mindestens 400 m² für Elektro- und Elektronikgeräte sowie diejenigen Lebensmittelgeschäfte mit einer Gesamtverkaufsfläche von mindestens 800 m², die mehrmals pro Jahr oder dauerhaft Elektro- und Elektronikgeräte anbieten und auf dem Markt bereitstellen. Dies gilt auch bei Vertrieb unter Verwendung von Fernkommunikationsmitteln, wenn die Lager- und Versandflächen für Elektro- und Elektronikgeräte mindestens 400 m² betragen oder die gesamten Lager- und Versandflächen mindestens 800 m² betragen. Verreiber haben die Rücknahme grundsätzlich durch geeignete Rückgabemöglichkeiten in zumutbarer Entfernung zum jeweiligen Endnutzer zu gewährleisten. Die Möglichkeit der unentgeltlichen Rückgabe eines Altgerätes besteht bei rücknahmepflichtigen Vertriebern unter anderem dann, wenn ein neues gleichartiges Gerät, das im Wesentlichen die gleichen Funktionen erfüllt, an einen Endnutzer abgegeben wird.

4. Datenschutz-Hinweis:

Altgeräte enthalten häufig sensible personenbezogene Daten. Dies gilt insbesondere für Geräte der Informations- und Telekommunikationstechnik wie Computer und Smartphones. Bitte beachten Sie in Ihrem eigenen Interesse, dass für die Löschung der Daten auf den zu entsorgenden Altgeräten jeder Endnutzer selbst verantwortlich ist.

5. Bedeutung des Symbols „durchgestrichene Mülltonne“:





Das auf Elektro- und Elektronikgeräten regelmäßig abgebildete Symbol einer durchgestrichenen Mülltonne weist darauf hin, dass das jeweilige Gerät am

Ende seiner Lebensdauer getrennt vom unsortierten Siedlungsabfall zu erfassen ist.

Symbol Conventions

The symbols that may be found in this document are defined as follows.

Symbol	Description
 Danger	Indicates a hazardous situation which, if not avoided, will or could result in death or serious injury.
 Caution	Indicates a potentially hazardous situation which, if not avoided, could result in equipment damage, data loss, performance degradation, or unexpected results.
 Note	Provides additional information to emphasize or supplement important points of the main text.

Safety Instruction

These instructions are intended to ensure that user can use the product correctly to avoid danger or property loss. Please read all the safety information carefully before using.

Laws and Regulations

- Use of the product must be in strict compliance with the local electrical safety regulations.

Transportation

- Keep the device in original or similar packaging while transporting it.
- Keep all wrappers after unpacking them for future use. In case of any failure occurred, you need to return the device to the factory with the original wrapper. Transportation without the original wrapper may result in damage on the device and the company shall not take any responsibilities.
- DO NOT drop the product or subject it to physical shock. Keep the device away from magnetic interference.

Power Supply

- Input voltage should meet the Limited Power Source (3.85 VDC, 570 mA) according to the IEC62368 standard. Please refer to technical specifications for detailed information.
- Make sure the plug is properly connected to the power socket.
- DO NOT connect multiple devices to one power adapter, to avoid overheating or fire hazards caused by overload.
- Use the power adapter provided by a qualified manufacturer. Refer to the product specification for detailed power requirements.

Battery

- Improper use or replacement of the battery may result in explosion hazard. Replace with the same or equivalent type only. Dispose of used

batteries in conformance with the instructions provided by the battery manufacturer.

- The built-in battery cannot be dismantled. Please contact the manufacture for repair if necessary.
- For long-term storage of the battery, make sure it is fully charged every half year to ensure the battery quality. Otherwise, damage may occur.
- Use the battery provided by a qualified manufacturer. Refer to the product specification for detailed battery requirements.
- DO NOT charge other battery types with the supplied charger. Confirm there is no flammable material within 2 m of the charger during charging.
- DO NOT place the battery near heating or fire source. Avoid direct sunlight.
- DO NOT swallow the battery to avoid chemical burns.
- DO NOT place the battery in the reach of children.
- When the device is powered off and the RTC battery is full, the time settings can be kept for 6 months.
- In the first use, charge the device for more than 2.5 hours in the power-off status.
- The lithium battery voltage is 3.85 V, and the battery capacity is 2100 mAh.
- The battery is certified by UL2054.

Maintenance

- If the product does not work properly, please contact your dealer or the nearest service center. We shall not assume any responsibility for problems caused by unauthorized repair or maintenance.
- A few device components (e.g., electrolytic capacitor) require regular replacement. The average lifespan varies, so periodic checking is recommended. Contact your dealer for details.
- Wipe the device gently with a clean cloth and a small quantity of ethanol, if necessary.
- If the equipment is used in a manner not specified by the manufacturer,

the protection provided by the device may be impaired.

- Please notice that the current limit of USB 3.0 PowerShare port may vary with the PC brand, which is likely to result in incompatibility issue. Therefore, it's advised to use regular USB 3.0 or USB 2.0 port if the USB device fails to be recognized by PC via USB 3.0 PowerShare port.
- Your camera will periodically perform a self-calibration to optimize image quality and measurement accuracy. In this process, the image will pause briefly and you will hear a "click" as a shutter moves in front of the detector. The self-calibration will be more frequent during start up or in very cold or hot environments. This is a normal part of operation to ensure optimum performance for your camera.

Calibration Service

- We recommend you send the device back for calibration once a year, and please contact the local dealer for the information on maintenance points. For more detailed calibration services, please refer to <https://www.hikmicrotech.com/en/calibrationservices/2>.

Using Environment

- Make sure the running environment meets the requirement of the device. The operating temperature shall be -10 °C to 50 °C (14 °F to 122 °F), and the operating humidity shall be 95% or less.
- This device can only be safely used in the region below 2000 meters above the sea level.
- Place the device in a dry and well-ventilated environment.
- DO NOT expose the device to high electromagnetic radiation or dusty environments.
- DO NOT aim the lens at the sun or any other bright light.
- When any laser equipment is in use, make sure that the device lens is not exposed to the laser beam, or it may burn out.
- DO NOT aim the lens at the sun or any other bright light.
- The device is suitable for indoor and outdoor uses, but do not expose it in wet conditions.

- The level of protection is IP 54.
- The pollution degree is 2.

Technical Support

The <https://www.hikmicrotech.com/en/contact-us.html> portal will help you as a HIKMICRO customer to get the most out of your HIKMICRO products. The portal gives you access to our support team, software and documentation, service contacts, etc.

Emergency

- If smoke, odor, or noise arises from the device, immediately turn off the power, unplug the power cable, and contact the service center.

Manufacture Address

Room 313, Unit B, Building 2, 399 Danfeng Road, Xixing Subdistrict,
Binjiang District, Hangzhou, Zhejiang 310052, China
Hangzhou Microimage Software Co., Ltd.

COMPLIANCE NOTICE: The thermal series products might be subject to export controls in various countries or regions, including without limitation, the United States, European Union, United Kingdom and/or other member countries of the Wassenaar Arrangement. Please consult your professional legal or compliance expert or local government authorities for any necessary export license requirements if you intend to transfer, export, re-export the thermal series products between different countries.

Contents

Chapter 1 Overview	1
1.1 Device Description	1
1.2 Main Function	1
1.3 Appearance	2
Chapter 2 Preparation	5
2.1 Charge Device	5
2.2 Power On/Off	5
2.2.1 Set Auto Power-off Duration	5
2.3 Operation Method	5
2.4 Menu Description	6
Chapter 3 Display Settings	7
3.1 Set Screen Brightness	7
3.2 Set Display Mode	7
3.3 Set Palettes	9
3.4 Adjust Display Temperature Range	10
3.5 Adjust Digital Zoom	11
3.6 Display OSD Info	11
Chapter 4 Temperature Measurement	13
4.1 Set Measurement Parameters	13
4.1.1 Set Unit	14
4.2 Set Image Measurement	14
4.3 Set Temperature Alarm	14
Chapter 5 Picture and Video	16
5.1 Capture Picture	16
5.2 Record Video	18
5.3 Manage Albums	19
5.4 View Recorded Files	21
5.5 Manage Files	22
5.6 Export Files	24

Pocket Series User Manual

Chapter 6 Connect Bluetooth	25
Chapter 7 Set LED Light	26
Chapter 8 Cast Device Screen to PC	27
Chapter 9 Set Macro Mode	28
Chapter 10 Connect Device to Wi-Fi	29
Chapter 11 Set Device Hotspot	30
Chapter 12 Thermal View Mobile Client Connection	31
12.1 Connect via Wi-Fi	31
12.2 Connect via Hotspot	31
Chapter 13 Maintenance	33
13.1 View Device Information	33
13.2 Set Date and Time	33
13.3 Upgrade Device	33
13.4 Restore Device	34
13.5 Initialize Memory Card	34
13.6 About Calibration	34
Chapter 14 Appendix	35
14.1 Common Material Emissivity Reference	35
14.2 Device Command	35
14.3 Device Communication Matrix	36
14.4 FAQ	36

Chapter 1 Overview

1.1 Device Description

The handheld thermography camera is a device with both optical images and thermal images. It can do thermography, video recording, snapshot capturing, alarm, and it can connect to Wi-Fi, hotspot and Bluetooth. The built-in high-sensitivity IR detector and high-performance sensor detects the variation of temperature and measure the real-time temperature. The temperature measurement range is -20 °C to 400 °C (-4 °F to 752 °F), with the accuracy of ± 2 °C (± 3.6 °F) or 2% when the ambient temperature is 15 °C to 35 °C (59 °F to 95 °F) and the object temperature is above 0 °C (32 °F).

The device is easy to use, and adopts ergonomic design. It is widely used for building inspection, HVAC, as well as electrical and mechanical equipment maintenance.

1.2 Main Function

Temperature Measurement

Device detects the real-time temperature, and displays it on the screen.

Fusion

Device can display fusion of thermal view and optical view.

Palettes and Alarm

Device supports multiple palettes, and you can set the palette mode according to the alarm function.

Client Software Connection

- Mobile Phone: You can view live view, capture snapshots, and record videos via HIKMICRO Viewer App on your phone. You can also, analyze

pictures offline, generate and share a report via the app. Scan the QR codes on the cover to download the App.



HIKMICRO Viewer Android



HIKMICRO Viewer iOS

- PC: You can download HIKMICRO Analyzer (<https://www.hikmicrotech.com/en/industrial-products/hikmicro-analyzer-software.html>) to analyze pictures offline professionally, and generate a custom format report on your PC.

Bluetooth

Device can be connected to headset via Bluetooth, and you can hear the voice in the recording.

1.3 Appearance

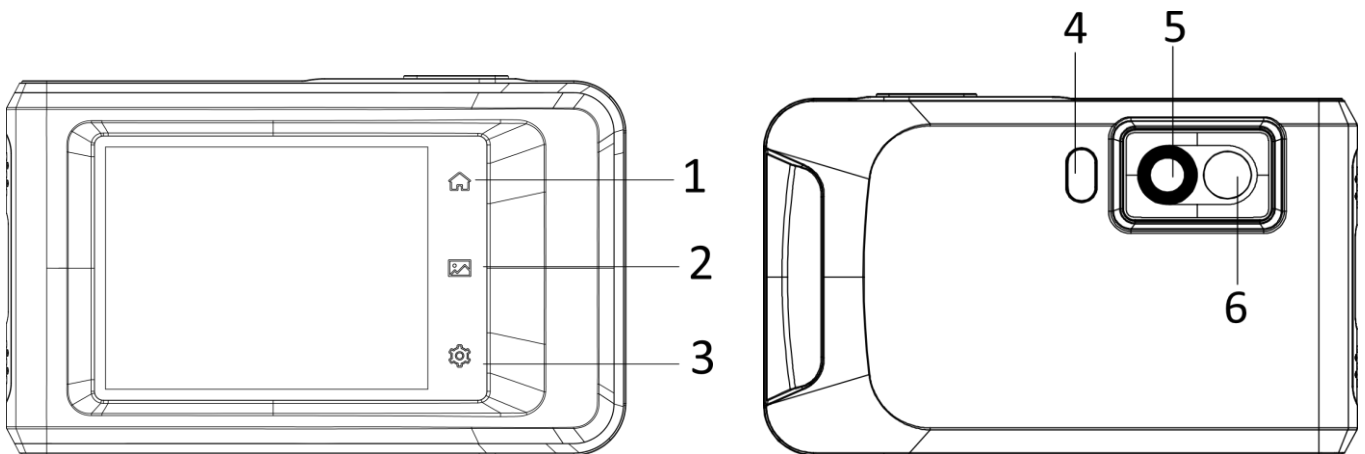

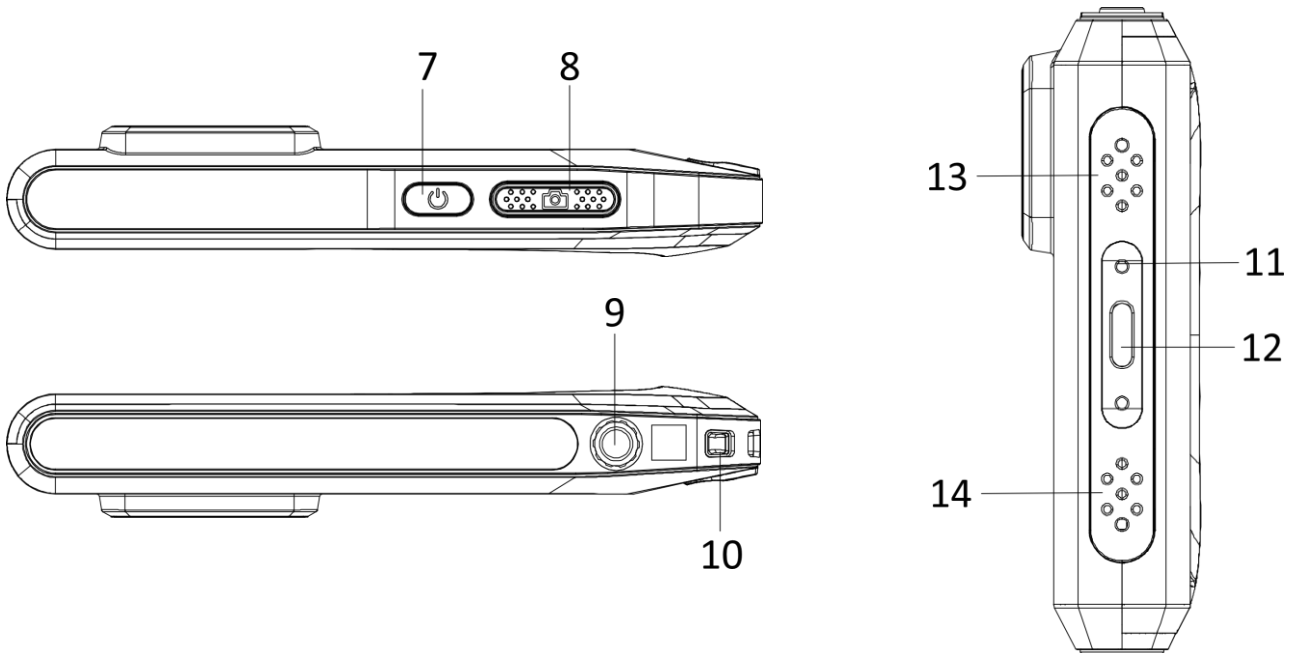

Figure 1-1 Appearance

Table 1-1 Button and Interface Description

No.	Description	Function
1	Home Key	Tap to return to the live view interface.
2	File Key	Tap to enter albums.
3	Settings Key	Tap to enter settings interface.
4	Flash Light	Fill light on objects and output flashing alarm.
5	Thermal Lens	View the thermal image.
6	Optical Lens	View the optical image.
7	Power Key	Hold to power on/off the device.
8	Capture Key	<ul style="list-style-type: none"> ● Press in live view mode: capture snapshots/stop recording ● Press in menu mode: return to the live view interface ● Hold: start recording

No.	Description	Function
9	Tripod Mount	Mount the tripod.
10	Strap Attachment Point	Mount the strap.
11	Indicator	Indicate the charging status of the device. <ul style="list-style-type: none">● Solid red: charging normally● Flashing red: charging exception● Solid green: fully charged
12	Type-C Interface	Charge the device or export files with Type-C cable.
13	Buzzer	Output audible alarm.
14	Microphone	Record audio.

 **Note**

Your camera will periodically perform a self-calibration to optimize image quality and measurement accuracy. In this process, the image will pause briefly and you'll hear a "click" as a shutter moves in front of the detector. The prompt "Calibrating ..." appears in the upper center of the screen as the device is calibrating itself. The self-calibration will be more frequent during start up or in very cold or hot environments. This is a normal part of operation to ensure optimum performance for your camera.

Chapter 2 Preparation

2.1 Charge Device

Plug in the cable, and connect the device to the power supply to charge the device.

2.2 Power On/Off

Power On

Hold  for over three seconds to turn on the device. You can observe the target when the interface of the device is stable.

Note

It may take at least 30 s until the device is ready for using when you power on it.

Power Off

When the device is turned on, hold  for about three seconds to power off the device.

2.2.1 Set Auto Power-off Duration

Select , and go to **Device Settings** → **Auto Power-off** to set the automatic shutdown time for device as required.

2.3 Operation Method

The device supports touch-screen control. You can tap the screen to set

parameters and configurations.

2.4 Menu Description

In the observation interface, tap the screen to show the menu bar, and swipe down to call the swipe-down menu.



- ① Home
- ② File
- ③ Settings
- ④ Menu

Figure 2-1 Main Menu

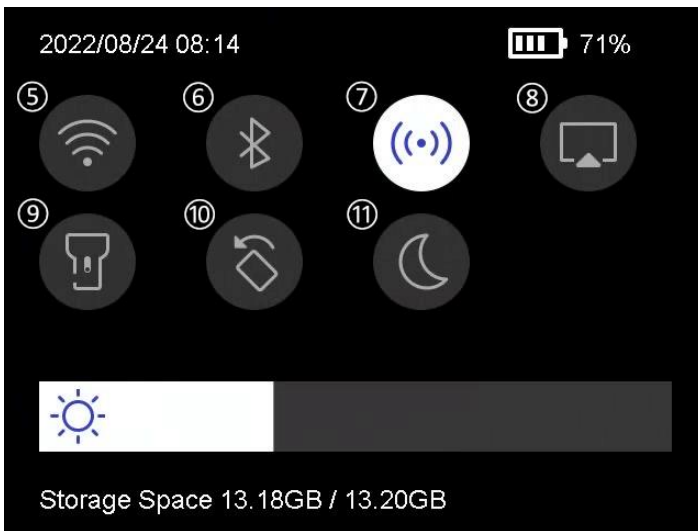

- ⑤ Wi-Fi
- ⑥ Bluetooth
- ⑦ Hotspot
- ⑧ Screen Cast
- ⑨ Flashlight
- ⑩ Auto-Rotate
- ⑪ Dark/Bright Mode

Figure 2-2 Swipe-Down Menu

Chapter 3 Display Settings

Note

Your device will periodically perform a self-calibration to optimize image quality and measurement accuracy. In this process the image will pause briefly and you'll hear a "click" as a shutter moves in front of the detector. The self-calibration will be more frequent during start up or in very cold or hot environments. This is a normal part of operation to ensure optimum performance for your device.

3.1 Set Screen Brightness

Go to **Settings** → **Device Settings** → **Screen Brightness** to adjust the screen brightness.

Or tap , and drag it to adjust the screen brightness.



Figure 3-1 Adjust Brightness via Swipe-Down Menu

3.2 Set Display Mode

You can set the thermal/optical view of the device. **Thermal**, **Fusion**, **PIP**, **Visual**, and **Blending** are selectable.

Steps

1. Tap **Menu**, and select .
2. Tap the icons to select a view mode.



In thermal mode, the device displays the thermal view.



In fusion mode, the device displays the combined view of thermal channel and optical channel.

 **Note**

When selecting the fusion mode, you need to set the parallax correction in the live view interface according to the distance to the target, so as to better overlap the thermal and optical images.



Figure 3-2 Adjust Parallax Correction



In PIP (Picture in Picture) mode, the device displays thermal view inside the optical view.

 **Note**

You can adjust the size, distance and digital zoom of the PIP.



In visual mode, the device displays the optical view.



In blending mode, the device displays the mixture view of thermal channel and optical channel. You can adjust the **Optical-Thermal**

Ratio to change the optical-thermal ratio. The lower the value is, the better the optical effect is.

 **Note**

When selecting the blending mode, you can adjust the **Optical-Thermal Ratio** from **0** to **100** in the live view interface. The higher the value is, the clearer the thermal images are.

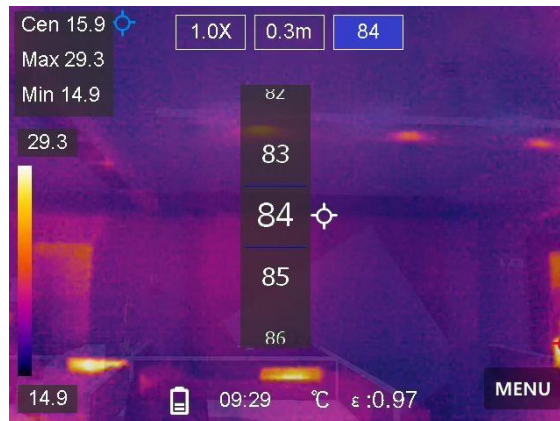



Figure 3-3 Adjust Optical-Thermal Ratio

3. Press **Back** to exit.

3.3 Set Palettes

The palettes allow you to select the desired colors.

Steps

1. Tap **Menu**, and select .
2. Tap the icons to select a palette type.

White Hot

The hot part is light-colored in view.

Black Hot

The hot part is black-colored in view.

Rainbow

The target displays multiple colors. It is suitable for scene without

obvious temperature difference.

Ironbow

The target is colored as heated iron.

Red Hot

The hot part is red-colored in view.

Fusion

The hot part is yellow-colored and the cold part is purple-colored in view.

Rain

The hot part in the image are colored, and the else is blue.

Blue Red

The hot part in the image is colored red, and the else is blue.

3. Press **Back** to exit the setting interface.

3.4 Adjust Display Temperature Range

Set a temperature range and the palette only works for targets within the temperature range. You can adjust the temperature range.

Steps

1. Tap **Menu**, and select .
2. Select auto adjustment  or manual adjustment .

Auto

Select . The device adjusts temperature range parameters automatically.

Manual

- a. Tap on an interest area of the screen. A circle is displayed around the area, and the temperature range readjusts to show as many details of the area as possible.
- b. Tap on the value on screen to lock or unlock a value.
- c. Scroll the adjustment wheel on the screen to fine-

tune the max. temperature and the min. temperature respectively.

d. Tap **OK** to finish.

3. Press **Back** to exit.

3.5 Adjust Digital Zoom

Steps

1. Tap the live view interface to call the digital zoom frame.
2. Tap the digital zoom frame.

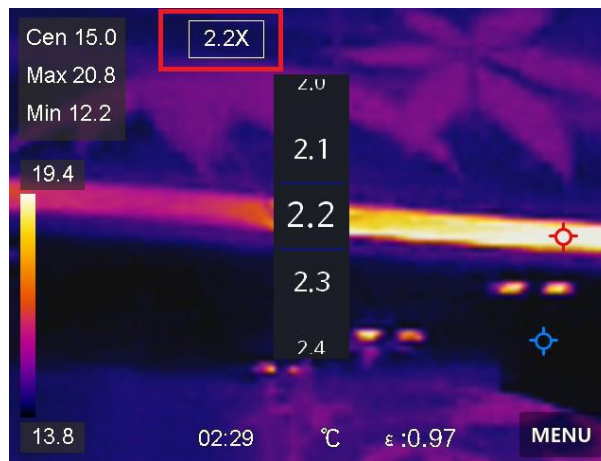

Figure 3-4 Adjust Digital Zoom

2. Select the digital zoom value as required
3. Tap the screen to save and exit.

3.6 Display OSD Info

Go to **Settings** → **Display Settings** to enable the information on-screen display.

Time and Date

Device time and date.

Parameters

Thermography parameters, for example, target emissivity, temperature unit, etc.

Brand Logo

The brand logo is a manufacturer logo displayed on the upper right corner of the screen.

Chapter 4 Temperature Measurement

The thermography (temperature measurement) function provides the real-time temperature of the scene and display it on the left of your screen. The thermography function is turned on by default.

4.1 Set Measurement Parameters

You can set measurement parameters to improve the accuracy of temperature measurement.

Steps

1. Go to **Settings** → **Measurement Settings**.
2. Set the **Temperature Range**, **Emissivity**, etc.

Temperature Range

Select the temperature measurement range. The device can detect the temperature and switch thermography range automatically in **Auto Switch** mode.

Emissivity

Refer to **Common Material Emissivity Reference** to set the emissivity of your target.

Reflection Temperature

If any object (not the target) of high temperature is in the scene, and the target emissivity is low, set the reflection temperature as the high temperature to correct the thermography effect.

Distance

The distance between the target and the device. You can customize the target distance or select the target distance as **Near**, **Middle**, or **Far**.

Humidity

Set the relative humidity of current environment.

3. Return to previous menu to save the settings.

Note

You can go to **Settings** → **Device Settings** → **Device Initialization** → **Remove All Measurement Tools** to initialize the temperature measurement parameters.

4.1.1 Set Unit

Go to **Settings** → **Device Settings** → **Unit** to set the temperature unit and distance unit.

4.2 Set Image Measurement

You can set measurement tools to measure the min., max., and center temperatures of the current scene.

Steps

1. Tap **Menu**, and select .
 2. Tap to select the thermography rule as required. **Hot**, **Cold**, and **Center** are selectable.
 3. Tap **Back** to save and exit.
-

Note

- The min., max., and center temperatures are displayed on the left top of the screen.
 - Tap the rule again to delete the rule.
-

4.3 Set Temperature Alarm

When the temperature of targets triggers the set alarm rule, the device will perform configured actions, such as making audible warning and flash

alarm.

Steps

1. Go to **Settings** → **Measurement Settings** → **Alarm Settings**.
2. Enable **Temperature Alarm** and set the alarm parameters.

Alarm Threshold

When the tested temperature exceeds the threshold, the device sends alarm notification to the client software. The device will buzz if the audible warning is enabled, and the flashlight will flash if the flashing alarm is enabled.

Alarm Linkage

- **Audible Warning:** The device beeps when target temperature exceeds the alarm threshold.
 - **Flashing Alarm:** The flash light flashes when target temperature exceeds the alarm threshold.
4. Tap < to save and exit.

Chapter 5 Picture and Video

Insert memory card into the device, and then you can record videos, capture snapshots, and mark and save important data.

Note

- The device does not support capturing or recording when the menu is shown.
 - When the device is connected to your PC, it does not support capturing or recording.
 - Go to **Settings** → **Capture Settings** → **Filename Header**, you can set the filename header for capturing or recording to distinguish the files recorded in a specify scene.
 - Go to **Settings** → **Device Settings** → **Device Initialization** to initialize the memory card as needed.
-

5.1 Capture Picture

Before You Start

Enable the flashlight via the swipe-down menu in dark environment.

Steps

1. Go to **Settings** → **Capture Settings**.
 - 1) Set **Capture Mode**. Three modes are available.

Capture One Image

Press  once to capture one image.

Note

If you need to edit captured images immediately, enable **Edit before Saving**.



Continuous Capture

Set the continuous capture amount after select this mode.

Press  in live view, and device captures the set amount of images continuously.

Scheduled Capture

Set the interval for scheduled capture after select this mode.

Press  in live view, and the device captures images according to the set interval. Press  again to stop capturing.



2) Set the naming rule for the saved files. The default image naming is filename header + saving time. **Filename Header** is configurable.

Saving time is the device system time when the saving occurs.

3) Optional: If a visual image is needed to be saved separately, enable **Save Visual Image** and set **Visual Image Resolution**.

Note

If the targets are in poor light condition, enable **Flashlight**. The device turns on the flashlight when capturing images.

2. Tap  to exit. In the live view interface, aim the lens to your target and press  to capture images.

Note

- For **Capture One Image**, if **Edit before Saving** is NOT enabled, the live image freezes and is saved in the default saving album. If **Edit before Saving** is enabled, the device enters the image editing interface.
 - For **Continuous Capture/Scheduled Capture**, a counter displays in top of the screen showing the completed amounts of capturing.
-

3. Edit the image.



Select text note and enter the editing page. Tap on screen to input

content and tap  to save.



View the image information.



Move the image to a required album.



Delete the image.

What to do next

- Tap  to enter albums to view and manage files and albums. See **Manage Albums** and **Manage Files** for operation instructions.
- You can connect your device to PC to export local files in albums for further use. See **Export Files**.

5.2 Record Video

Before You Start

Enable the flashlight via the swipe-down menu in dark environment.

Steps

1. In the live view interface, hold the capture key to start recording. The recording icon and count down number display in the interface.















Figure 5-1 Record Video

2. When you finish, press the capture key to stop recording. The recording video will be saved automatically.
3. Refer to **Export Files** to export the videos.

5.3 Manage Albums

The recorded image/video files are saved in the albums. You can create new albums, rename an album, change the default album, move files between the albums, and delete albums.

Task	Operations
Create a New Album	<ol style="list-style-type: none"> 1. Press  to enter Albums. 2. Tap  to add a new album. 3. A soft keyboard is displayed, where you can enter the name of the album by touching the screen. 4. Tap  to finish.

Task	Operations
	<hr/> <p> Note</p> <p>The newly created album becomes the default saving album and appears at the top of the album list.</p> <hr/>
Rename an Album	<ol style="list-style-type: none"> 1. Press  to enter Albums. 2. Select the album to rename. 3. Tap , and select Rename. A soft keyboard is displayed. 4. Tap  to delete the old name, and enter the new name for the album by touching the screen. 5. Tap  to finish.
Change the Default Saving Album	<ol style="list-style-type: none"> 1. Press  to enter Albums. 2. Select the album you want to use as the default saving album. 3. Tap , and select Set as Default Saving Album. <hr/> <p> Note</p> <p>The default saving album appears at the top of the album list.</p> <hr/>
Delete an Album	<ol style="list-style-type: none"> 1. Press  to enter Albums. 2. Select the album you want to delete. 3. Tap , and select Delete. A prompt box appears on the interface. 4. Tap OK to delete the album.

Task	Operations
	<p> Note</p> <p>The files in an album are deleted as well when deleting the album. Move the files to other albums if they are still needed. See <u>Manage Files</u> for instructions.</p>

5.4 View Recorded Files

Steps



1. Press  to enter **Albums**.
2. Tap to select the album storing the files.
3. Tap to select the video or snapshot to view.
4. View the selected file and relevant information.



Figure 5-2 View a File

Note





- Files are arranged in chronological order, with the most recent at the top. If you fails to find the most recently taken snapshots or videos,









please check the time and date settings of your device. See **Set Date and Time** for instructions. When you are viewing files, you can switch to other files by tapping  or .

- For more information contained in capture snapshots or videos, you can install the thermography client to analyze them.

5.5 Manage Files



You can move, delete, edit the recorded files, and add text notes to the files.

Task	Operations
Delete a File	<ol style="list-style-type: none"> 1. Press  to enter Albums. 2. Tap to select the album storing the file to be deleted. 3. In the album, tap to view the file to be deleted. 4. Tap the screen to show the menu bar below, and tap . A prompt box appears on the interface. 5 Tap OK to delete the file.
Delete Multiple Files	<ol style="list-style-type: none"> 1. Press  to enter Albums. 2. Tap to select the album storing the files to be deleted. 3. In the album, tap , and tap the files to be deleted. 4. Tap . A prompt box appears on the interface. 5. Tap OK to delete the files.

Task	Operations
	<hr/> <p> Note</p> <p>You can also delete a single file in this way.</p> <hr/>
Move a File	<ol style="list-style-type: none"> 1. Press  to enter Albums. 2. Tap to select the album storing the file to be moved. 3. In the album, tap to view the file to be moved. 4. Tap the file to show the menu bar below, and select . The album list is displayed. 5. Tap to select the album to move to.
Move Multiple Files	<ol style="list-style-type: none"> 1. Press  to enter Albums. 2. Tap to select the album storing the files to be moved. 3. In the album, tap  to select the files to be moved. 4. Tap . The album list is displayed. 5. Tap to select the album to move to. <hr/> <p> Note</p> <p>You can also move a single file in this way.</p> <hr/>
Add Text Note on File	<ol style="list-style-type: none"> 1. Press  to enter Albums. 2. Tap to select the album storing the file to be edited. 3. In the album, tap to view the file to be edited. 4. Tap the screen to show the menu bar below, and tap . A soft keyboard is displayed.

Task	Operations
	<p>5. Enter the text note by touching the screen. 6. Tap  to finish.</p> <p>What to do next You can open the edited photo to view the text note.</p>

 **Note**

You can tap  to select all files, and tap  to cancel the selection.

5.6 Export Files

Connect the device to your PC with supplied cable, you can export the recorded videos and captured snapshots.

Steps

1. Connect the device to your PC with cable and open the detected disk.
2. Select and copy the videos or snapshots to PC to view the files.
3. Disconnect the device from your PC.

 **Note**

- Please make sure to disable **Cast Screen** before connecting the device to your PC.
- For the first-time connection, the driver will be installed automatically.

Chapter 6 Connect Bluetooth

You can record and hear the sound contained in the videos via bluetooth headsets after pairing the device with bluetooth headsets successfully.

Steps

1. Go to **Settings** → **Connections** → **Bluetooth**.
2. Tap  to enable **Bluetooth**.

Note

You can also press  to quit pairing.

The device will search the nearby enabled bluetooth headsets and pair them automatically.

Result

After pairing you can hear the sound via the headsets while playing the video.

Chapter 7 Set LED Light

Tap the flashlight button on the swipe-down menu to enable the LED light.

Chapter 8 Cast Device Screen to PC

The device supports casting screen to PC by UVC protocol-based client software or player. You can connect the device to your PC via a type-C cable, and cast the real-time live view of the device to your PC.

Steps

1. Go to **Settings** → **Connections** → **Cast Screen**.
2. Tap to enable the function.
3. Open UVC Alarm Client on your PC.
4. Connect the device to your PC via a type-C cable.

Note

Exporting files via USB connection is not allowed when you are casting the screen.

What to do next

For more instructions about how to cast the screen, please visit our website: <https://www.hikmicrotech.com>.

Chapter 9 Set Macro Mode

In the macro mode, you can focus extremely close on a very small object, and the object appears much larger in the view (and in the final image) compared to the standard lens.

Before You Start

- Install the macro lens before using this function. Refer to the quick start guide of the macro lens for detailed operation.
- The macro lens is not included in the package. Please purchase it separately. The recommended model is HM-P201- MACRO.

Steps

1. Go to **Settings** → **Capture Settings** → **Macro Mode**.
2. Tap  to enable the function.

Note

- After the macro mode is enabled, only the emissivity can be modified. Parameters such as distance, image mode, parallax correction, and measurement range cannot be modified.
 - After this function is disabled, the parameters will be restored to the previous set values, and the measurement range will be set to auto switch.
-

Chapter 10 Connect Device to Wi-Fi

Steps

1. Go to **Settings** → **Connections** → **WLAN**.
2. Tap to enable Wi-Fi, and the searched Wi-Fi will be listed.

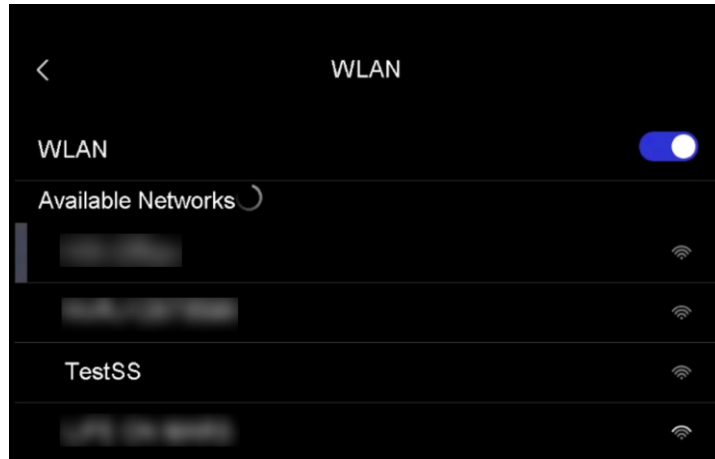

Figure 10-1 Wi-Fi List

3. Select the Wi-Fi to connect to. A soft keyboard is displayed.
4. Enter the password by touching the screen.

Note

- DO NOT tap **space** in your password, or the password may be incorrect.
 - Please tap to enter password into the password field.
-

5. Tap to save and connect Wi-Fi.

Result

A Wi-Fi icon shows on the main interface when the connection is completed.

Chapter 11 Set Device Hotspot

With the device hotspot, other equipment with Wi-Fi function can join the device for data transmission.

Steps

1. Go to **Settings** → **Connections** → **Hotspot**.
3. Tap to enable the hotspot function. The hotspot name is the last 9 digits of the device serial No.
4. Tap **Set Hotspot**. A soft keyboard is displayed.

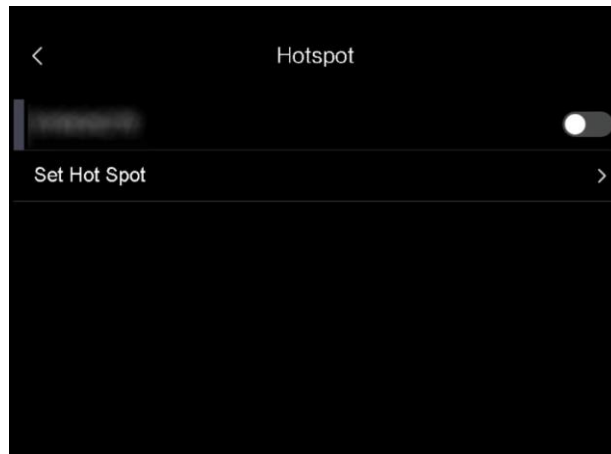



Figure 10-2 Set Hotspot

5. Set the password for the hotspot.

Note

- DO NOT tap **space** in your password, or the password may be incorrect.
 - The password should at least contain 8 digits, consisting of numbers and characters.
 - Please tap  to enter password into the password field.
-

6. Tap to save.

Chapter 12 Thermal View Mobile Client Connection

The device supports both Wi-Fi connection and hotspot. Connect the device to HIKMICRO Viewer, and you can control the device via mobile client.

12.1 Connect via Wi-Fi

Before You Start

Download and install HIKMICRO Viewer on your phone.

Steps

1. Connect your device to a Wi-Fi network. See [Connect Device to Wi-Fi](#) for instructions.
2. Connect your phone to the Wi-Fi network that the device is in.
3. Launch the app and follow the startup wizard to create, and register an account.
4. Search and add the device to the mobile client.

Result

You can view the live view, capture snapshots, and record videos via the client.

12.2 Connect via Hotspot

Before You Start

Download and install HIKMICRO Viewer on your phone.

Steps

1. Turn on the device hop spot and complete hot spot settings. See [Set Device Hotspot](#) for instructions.

2. Connect your phone to the Hot Spot of the device.
3. Launch the app and follow the startup wizard to create, and register an account.
4. Search and add the device to the mobile client.

Result

You can view the live view, capture snapshots, and record videos via the client.

Chapter 13 Maintenance

13.1 View Device Information

Go to **Settings** → **Device Settings** → **Device Information** to view the device information.

13.2 Set Date and Time

Steps

1. Go to **Settings** → **Device Settings** → **Time and Date**.
2. Set the date and time.
3. Press < to save and exit.

Note

Go to **Settings** → **Device Settings** → **Display Settings** to enable or disable time and date display.

13.3 Upgrade Device

Before You Start

Please download the upgrade file from the official website <http://www.hikmicrotech.com> or contact the custom service and technical support to get the upgrade file first.

Steps

1. Connect the device to your PC with cable and open the detected disk.
2. Copy the upgrade file and paste it to the root directory of the device.
3. Disconnect the device from your PC.

4. Reboot the device and then it will upgrade automatically. The upgrading process will be displayed in the main interface.
-

 **Note**

After upgrading, the device reboots automatically. You can view the current version in **Settings** → **Device Settings** → **Device Information**.

13.4 Restore Device

Go to **Device Settings** → **Device Initialization** → **Restore Device** to initialize the device and restore default settings.

13.5 Initialize Memory Card

When a memory card is use on the handheld thermal camera for the first time, it needs to be initialized first.

Select , and go to **Device Settings** → **Device Initialization** → **Format Storage Card** to initialize the memory card.

 **Caution**

If there are files in the memory card, make sure that the files has been backed up before memory card initialization. Once the card is initialized, data and files cannot be recovered.

13.6 About Calibration

We recommend you send the device back for calibration once a year, and please contact the local dealer for the information on maintenance points. For more detailed calibration services, please refer to <https://www.hikmicrotech.com/en/calibrationservices/2>.

Chapter 14 Appendix

14.1 Common Material Emissivity Reference

Material	Emissivity
Human Skin	0.98
Printed Circuit Board	0.91
Concrete	0.95
Ceramic	0.92
Rubber	0.95
Paint	0.93
Wood	0.85
Pitch	0.96
Brick	0.95
Sand	0.90
Soil	0.92
Cloth	0.98
Hard Paperboard	0.90
White Paper	0.90
Water	0.96

14.2 Device Command

Scan the following QR code to get device common serial port commands. Note that the command list contains the commonly used serial port

commands for HIKMICRO thermal cameras.



14.3 Device Communication Matrix

Scan the following QR code to get device communication matrix. Note that the matrix contains all communication ports of HIKMICRO thermal cameras.



14.4 FAQ

Scan the following QR code to get device common FAQ.





HIKMICRO

See the World in a New Way