

EN - User's manual

E27













AC/DC current clamp

Measure up 

Thank you for purchasing an **E27 AC/DC current clamp**, which we trust will give you satisfaction.

For best results from your instrument:

- **read** this user manual carefully,
- **comply** with the precautions for use.

	WARNING, risk of DANGER! The operator must refer to this user's manual whenever this danger symbol appears.
	May be placed on and removed from conductors at dangerous voltages. Type A current sensor as per IEC/EN 61010-2-032 or BS EN 61010-2-032.
	Equipment protected by double insulation.
	Useful information or tip.
	Battery.
	USB.
	To identify the phase (or the direction) of the primary current.
	Chauvin Arnoux has adopted an Eco-Design approach in order to design this appliance. Analysis of the complete life-cycle has enabled us to control and optimize the effects of the product on the environment. In particular this appliance exceeds regulation requirements with respect to recycling and reuse.
	
	The CE marking indicates compliance with the European Low Voltage Directive, 2014/35/UE, the Electromagnetic Compatibility Directive, 2014/30/EU, and the Restriction of Hazardous Substances Directive, (RoHS 2011/65/UE and 2015/863/UE).
	The UKCA marking certifies that the product is compliant with the requirements that apply in the United Kingdom, in particular as regards Low-Voltage Safety, Electromagnetic Compatibility, and the Restriction of Hazardous Substances.
	The rubbish bin with a line through it indicates that, in the European Union, the product must undergo selective disposal in compliance with Directive WEEE 2012/19/UE: This equipment must not be treated as household waste.

Definition of measurement categories

- Measurement category IV corresponds to measurements taken at the source of low-voltage installations.
Example: power feeders, counters and protection devices.
- Measurement category III corresponds to measurements on building installations.
Example: distribution panel, circuit-breakers, machines or fixed industrial devices.
- Measurement category II corresponds to measurements taken on circuits directly connected to low-voltage installations.
Example: power supply to domestic electrical appliances and portable tools.

PRECAUTIONS FOR USE

This device is compliant with safety standard IEC/EN 61010-2-032 or BS EN 61010-2-032, for voltages up to 600V in category III or 300 V in category IV.

Failure to observe the safety instructions may result in electric shock, fire, explosion, and destruction of the instrument and of the installations.

- The operator and/or the responsible authority must carefully read and clearly understand the various precautions to be taken in use. Sound knowledge and a keen awareness of electrical hazards are essential when using this instrument.
- If you use this instrument other than as specified, the protection it provides may be compromised, thereby endangering you.
- Do not use the instrument on networks of which the voltage or category exceeds those mentioned.
- Do not use the instrument if it seems to be damaged, incomplete, or poorly closed.
- Before each use, check the condition of the insulation on the leads and housing. Any item of which the insulation is deteriorated (even partially) must be set aside for repair or scrapping.
- When handling the instrument, keep your fingers behind the guard.
- Do not expose the clamp to sprays of water.
- Use personal protection equipment systematically.
- All troubleshooting and metrological checks must be done by competent, accredited personnel.

CONTENTS

1. PRESENTATION	4
1.1. Delivery condition	4
1.2. Accessories	4
1.3. Inserting the battery	4
1.4. Functions	4
1.5. E27 clamp.....	5
2. USE.....	6
2.1. Getting started	6
2.2. Zero adjustment.....	6
2.3. Measurement.....	6
2.4. Auto off	7
2.5. Indicators	7
2.6. Mains adapter (option).....	7
3. SPECIFICATIONS.....	8
3.1. Reference conditions.....	8
3.2. Electrical characteristics	8
3.3. Operating limits.....	12
3.4. Variations in the range of use	12
3.5. Power supply	12
3.6. Environmental conditions	13
3.7. Construction specifications.....	13
3.8. Conformity to international standards.....	14
3.9. Electromagnetic compatibility	14
4. MAINTENANCE.....	15
4.1. Cleaning	15
4.2. Replacing the battery.....	15
4.3. Manual adjustment	15
5. WARRANTY.....	17

1. PRESENTATION

1.1. DELIVERY CONDITION

The E27 clamp is delivered in a cardboard box with:

- one 9V alkaline battery (type 6LR61 or NEDA 1604A),
- one multilingual getting started guide,
- one multilingual safety data sheet,
- a verification certificate.

1.2. ACCESSORIES

One 5V, 500mA external power supply comprising:

- one mains/USB type A adapter
- one USB type A/micro-USB type B cable

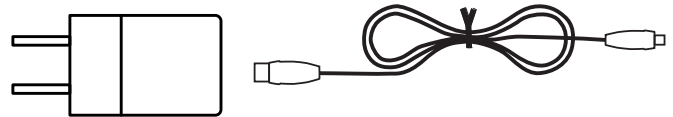

For the accessories and spares, consult our web site:

www.chauvin-arnoux.com

1.3. INSERTING THE BATTERY

- Use a screwdriver to unscrew the captive screw of the battery compartment cover.
- Slide the battery compartment cover off.
- Connect the battery to the snap-on connector; take care with the polarity.
You can use a rechargeable Ni-MH battery, but the life will be shorter. The instrument does not recharge rechargeable batteries.
- Place the battery in its compartment.
- Put the battery compartment cover back in place; make sure that it is completely and correctly closed.
- Screw the screw back in.

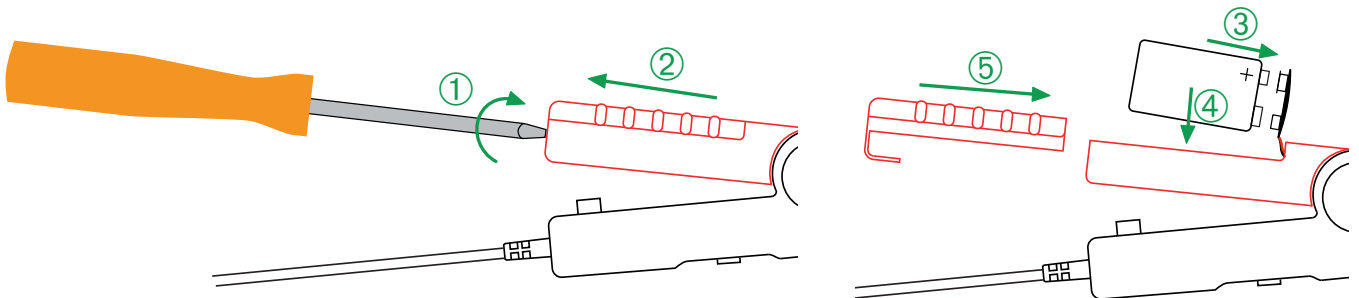

1.4. FUNCTIONS

The E27 clamp can be used to measure current from 100mA to 100 A_{peak} without opening the circuit in which it is flowing. It reads out the waveform and amplitude of the current being measured, in the form of a voltage. The pass band is from DC to 100kHz.

The shape of the clamp enables it to reach hard-to-reach places.

This clamp is used with an oscilloscope.

It can be powered by a battery or at 5VDC via the micro-USB connector.

It has:

- a reset pushbutton,
- a range overshoot indicator,
- a power supply indicator,
- automatic standby to prolong battery life.

1.5. E27 CLAMP

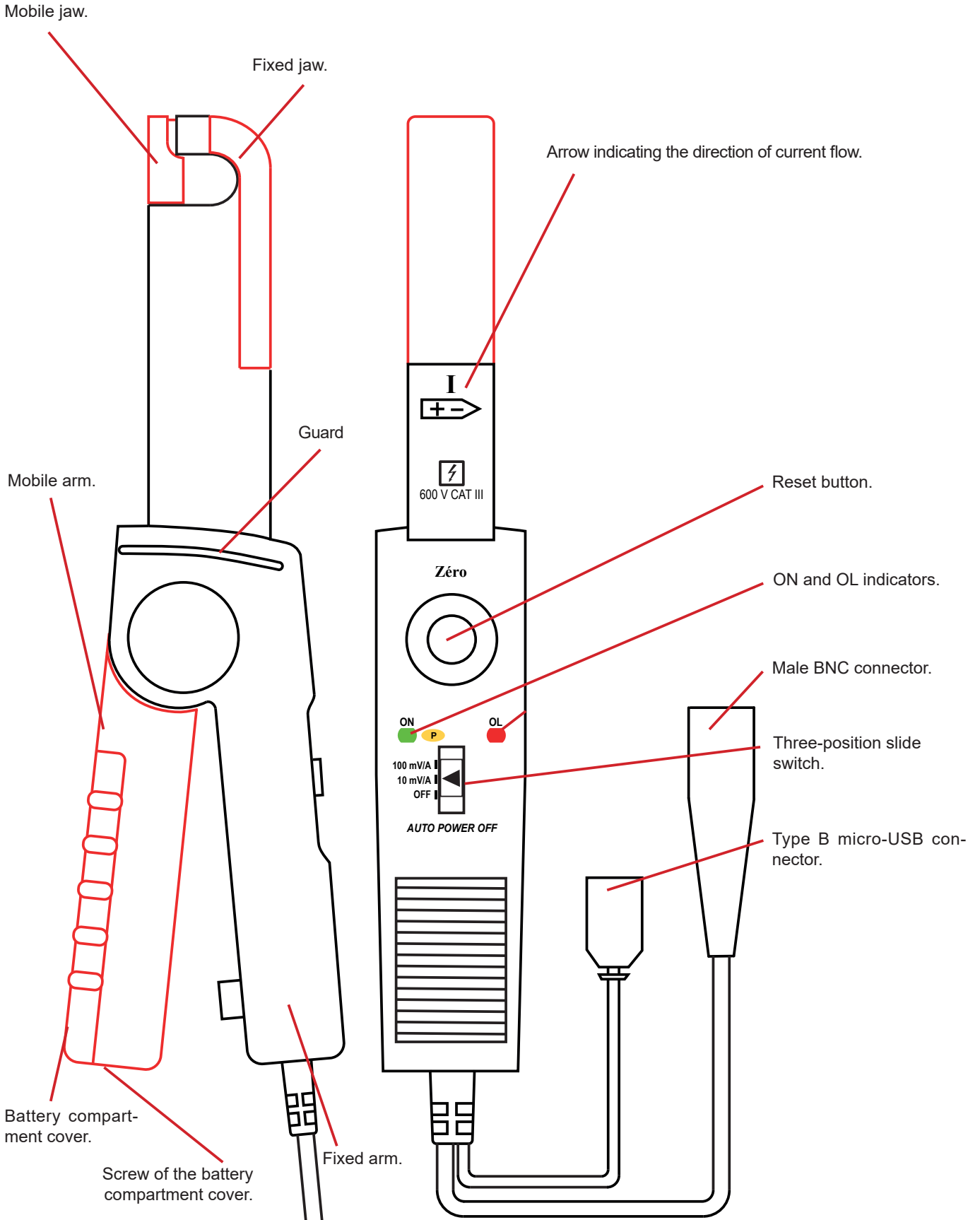

2. USE

2.1. GETTING STARTED

Switch the clamp on by pushing the slide switch to the 10mV/A or the 100mV/A setting.

The 10mV/A setting corresponds to the 100A range.

The 100mV/A setting corresponds to the 10A range.

The **ON** indicator lights green. If it blinks, there remain less than 4 hours of use. If it fails to light, you must replace the battery (see § 4.2).

It takes 10 seconds to set the clamp up for use.

2.2. ZERO ADJUSTMENT

- Switch the clamp on.
- Connect the clamp to the measuring instrument. The phase is on the core of the BNC connector.
- Make sure that the clamp is not on a conductor and that its jaws are correctly closed.
- Place the clamp in the position it will be in during the measurement.
- Press the zero adjustment button.
- The **OL** indicator lights for approximately three seconds to indicate that the zero adjustment is in progress in the two ranges.
- If the zero has been correctly adjusted, the **OL** indicator goes off. If it remains on, the zero could not be adjusted. In this case, check that the clamp is not on any conductor and that its jaws are correctly closed, then press the zero adjustment button again.
Or switch the clamp off and back on, and it is the last adjustment stored that will be used.

2.3. MEASUREMENT

 The zero must be adjusted before each measurement.

- Once the zero has been adjusted, press the moving arm of the clamp to open the jaws.
- Clamp the cable carrying the current to be measured. Use the centring marks to help you centre the cable inside the jaws of the clamp.

The arrow on the clamp must point in the presumed direction of current flow.

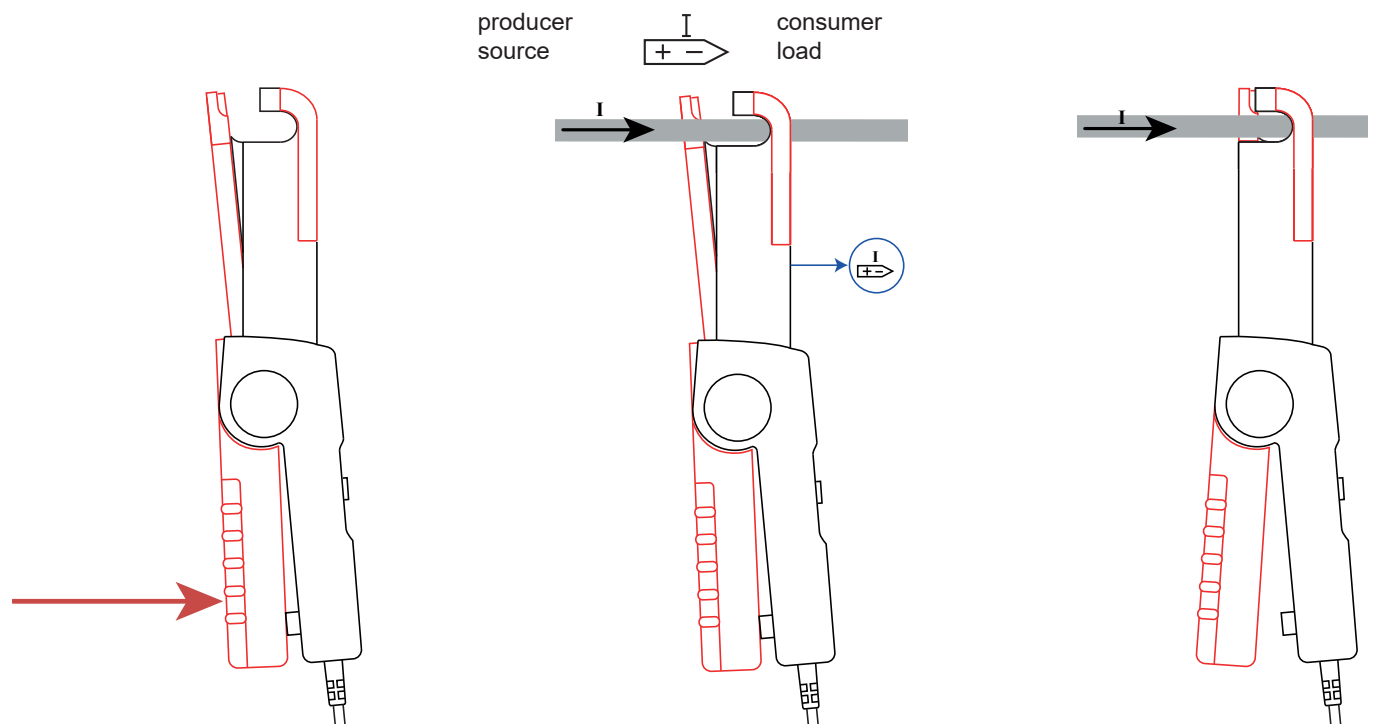

- Release the moving arm gently and make sure that the jaws are correctly closed.
- The value measured is displayed on the measuring instrument.

If the **OL** indicator lights, it means that the current is too strong to be measured. If you are in the 100mV/A range, switch to the 10mV/A range.

- Apply the conversion factor corresponding to the setting of the switch.

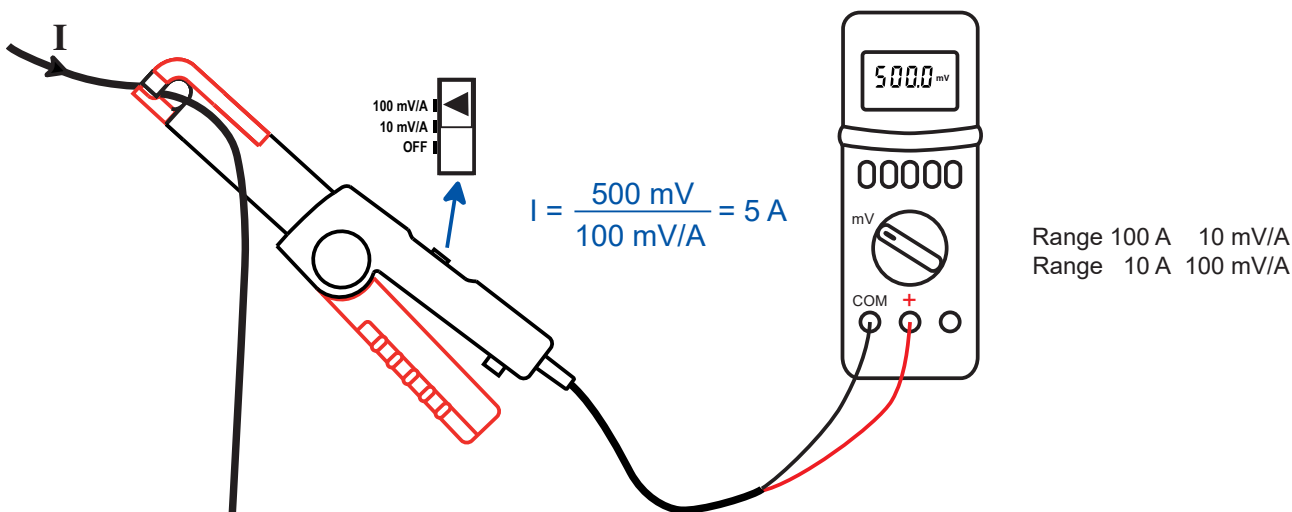

2.4. AUTO OFF

At the end of 10 minutes of operation with no sign of the user’s presence (a press on the zero adjustment button or an action on the switch), the clamp switches to standby and the **ON** indicator goes off.

To wake up the clamp, press the zero adjustment button or set the switch to a position other than **OFF**.

To disable auto off (operation in permanent mode **P**), press the zero adjustment button when starting up the instrument. The **ON** indicator blinks to indicate that the request has been taken into account, then lights steady orange when you release the zero adjustment button.

When the clamp is switched off (switch set to **OFF**), the auto off function is re-activated.

2.5. INDICATORS

ON indicator	
●	Off: instrument off
●	Lighted green: instrument on
●	Blinking green: the batteries will have to be replaced in less than 4h
●	Lighted orange: permanent operation P (auto off deactivated)

OL indicator	
●	Off: the measurement is correct
●	Lighted red: The measurement exceeds the range
● 3 s	Lighted red for 3 seconds: the zero adjustment is in progress.

2.6. MAINS ADAPTER (OPTION)

For long-term measurements, you can connect the clamp to mains using the optional line power adapter. You can use any mains/micro-USB adapter that delivers 50mA or more.

When the instrument is powered via the micro-USB connector, automatic standby is disabled.

The insulation between the type B micro-USB connector and the measurement output is 600V CAT III. This makes it possible to connect the clamp, without risk, to measuring instruments having inputs that are not insulated. The type B micro-USB connector must not be in contact with conductors or uninsulated parts at dangerous voltage.

If the external power supply is disconnected, the clamp changes back to battery-powered operation. The colour of the **ON** indicator indicates whether automatic standby is enabled (indicator green) or not (indicator orange).

3. SPECIFICATIONS

3.1. REFERENCE CONDITIONS

Quantity of influence	Reference values
Temperature	23 ± 5 °C
Relative humidity	20 to 75%RH
Position of the conductor	centred
Frequency of the measured signal	DC to 65 Hz sine wave
Powered	by battery: 6.5 to 9 V external supply: 5 V ± 0.1 V
External electric field	zero
External DC magnetic field (earth's field)	< 40 A/m
External AC magnetic field	zero
Impedance of the measuring instrument	≥ 1 MΩ and ≤ 100 pF

The **intrinsic uncertainty** is the error specified for the reference conditions.

It is expressed as a percentage of the output signal (R) plus an offset in mV:
 $\pm (a\% R + b)$

3.2. ELECTRICAL CHARACTERISTICS

Range	10mV/A (100A)		
	100mV/A (10A)	0.5 to 40 Apeak	40 to 100 Apeak
Specified measurement range	0.1 to 10 Apeak	0.5 to 40 Apeak	40 to 100 Apeak
Intrinsic uncertainty	≤ ± (3%L + 5 mV)	≤ ± (4%L + 0,5 mV)	≤ ± 15%L
Phase shift (DC to 65Hz)	≤ 1.5°	≤ 1°	≤ 1°

3.2.1. TYPICAL CURVES

Typical amplitude error curve for a DC current, 10mV/A range

Error (%)

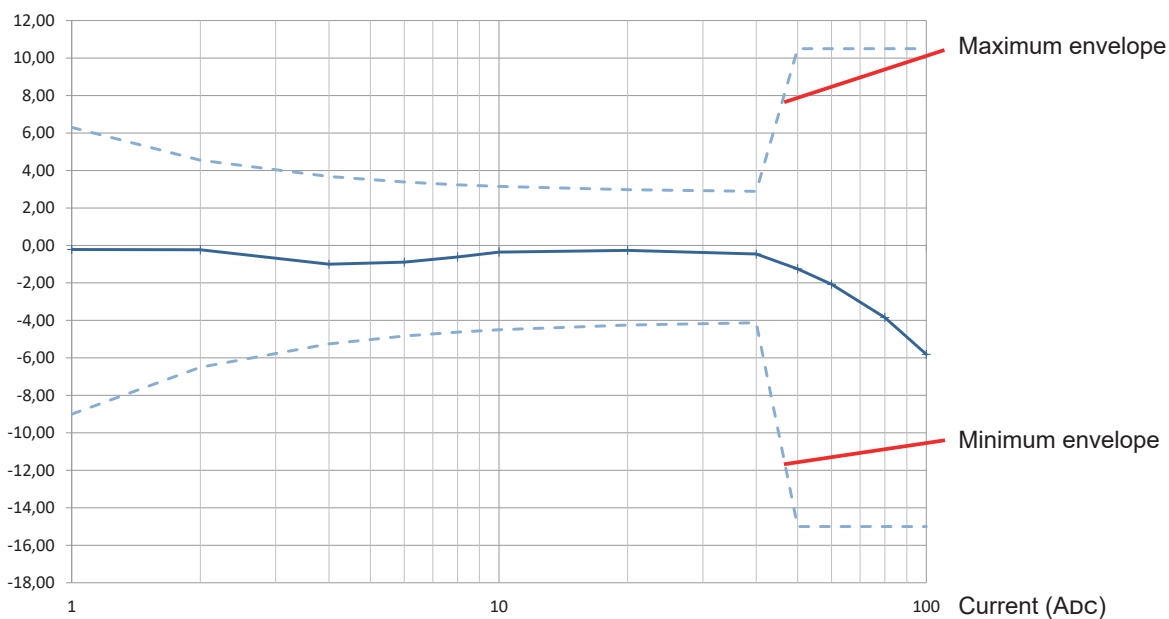

Typical amplitude error curve for a 60Hz AC current, 10mV/A range

Error (%)

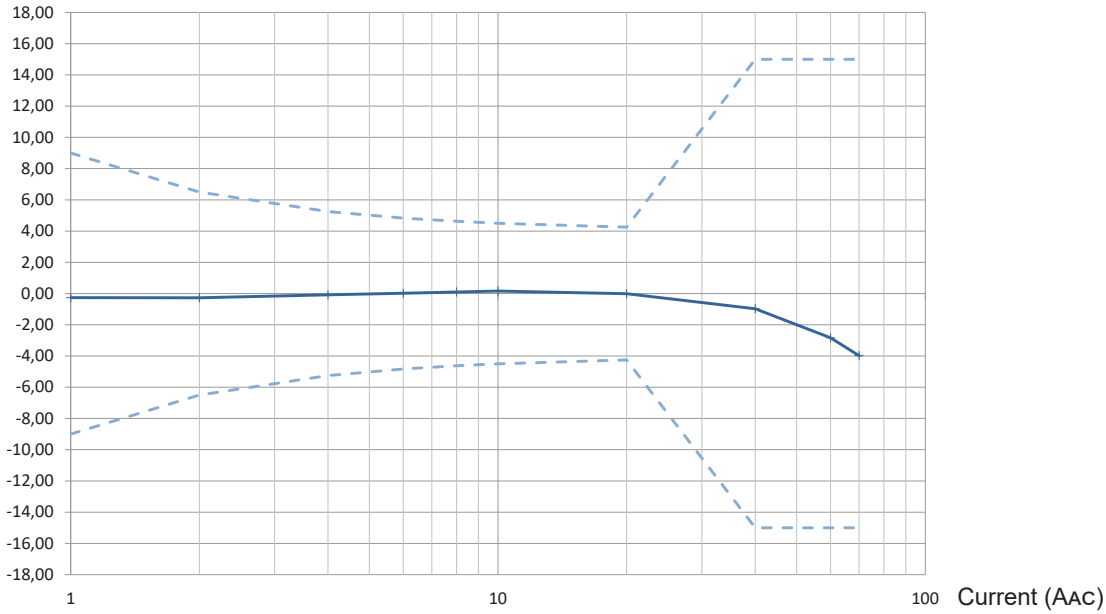

3.2.2. NOISE

Typical noise level at output	
10mV/A range	± 600 μV _{peak to peak}
1V/A range	± 5 mV _{peak to peak}

3.2.3. ZERO ADJUSTMENT

Minimum zero adjustment range: ± 1 A_{dc} in steps of approximately 0.9 mA.

3.2.4. FREQUENCY RESPONSE

Typical amplitude error curve at 1 A versus frequency, 10mV/A range

Error (%)

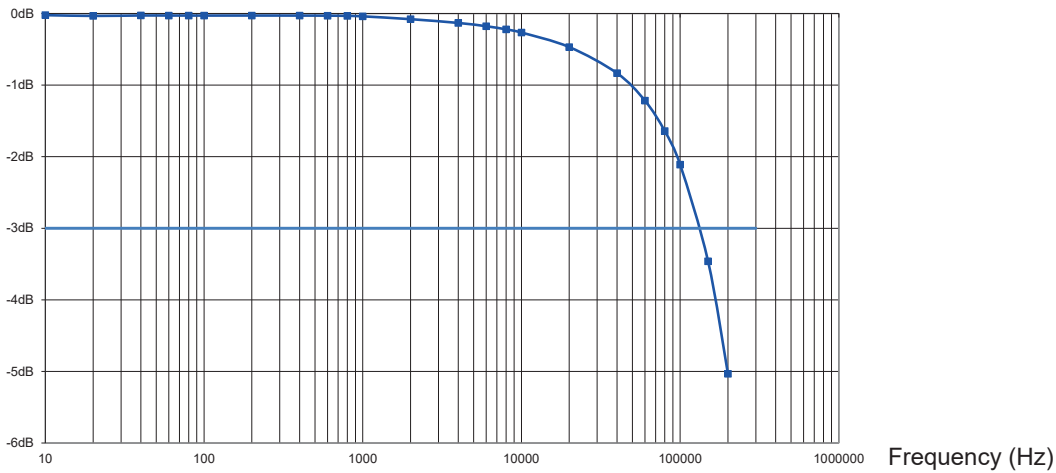

Typical amplitude error curve at 1A versus frequency, 100mV/A range

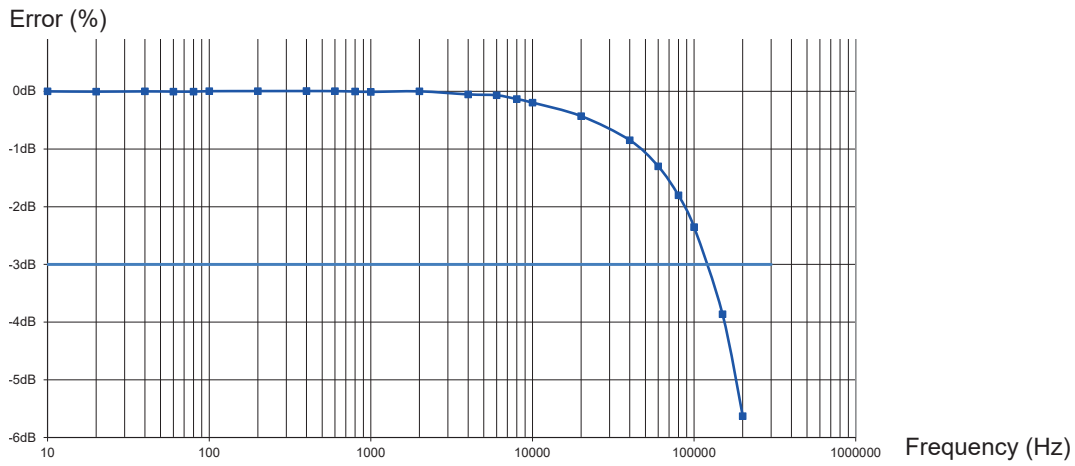

Typical amplitude error curve as a function of frequency, I = 1A, 10mV/A range

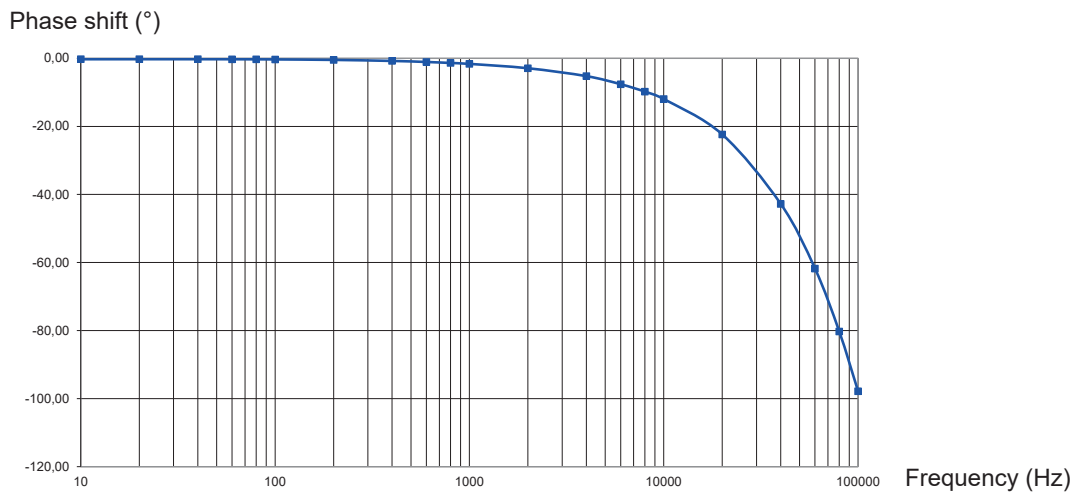

Typical amplitude error curve as a function of frequency, I = 1A, 100mV/A range

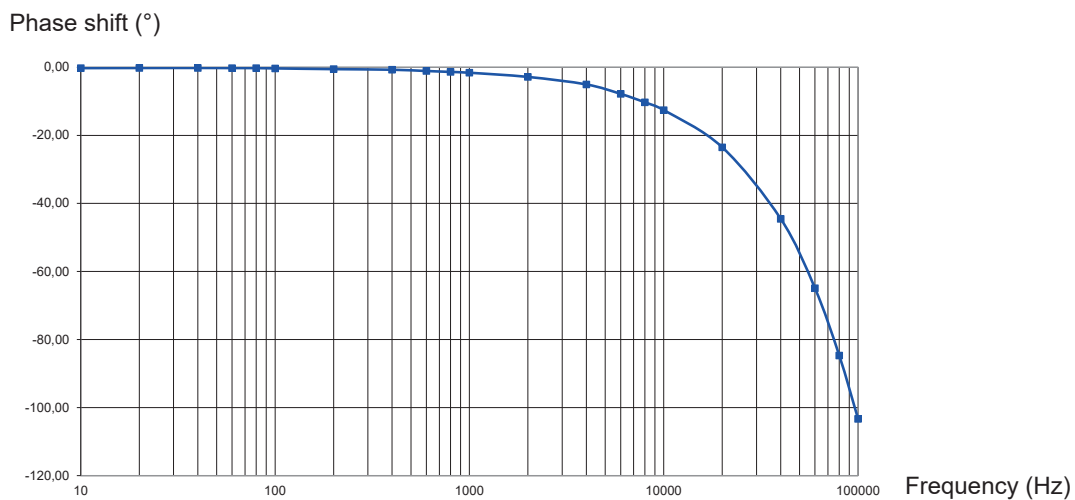

3.2.5. FREQUENCY CHARACTERISTICS

Range	10mV/A	100mV/A
Pass band to 3 dB down	DC to 100 kHz	
Rise time (10 to 90%) and fall time (90 to 10%)	3 μ s	
Response time to 10%	1.8 μ s	
Insertion impedance at 10 kHz	2 m Ω	
Insertion impedance at 50 kHz	10 m Ω	

3.2.6. PULSE RESPONSE

Pulse response at ± 2 Apeak at the frequency of 1kHz in the 10mV/A range

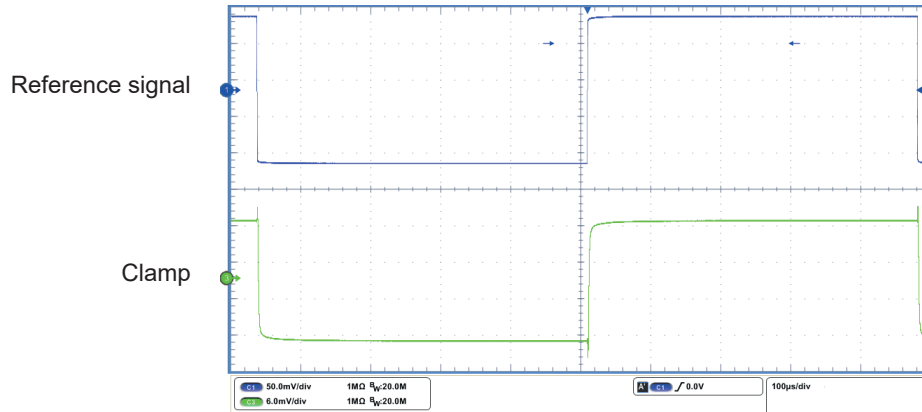

Pulse response at ± 2 Apeak at the frequency of 1kHz in the 100mV/A range

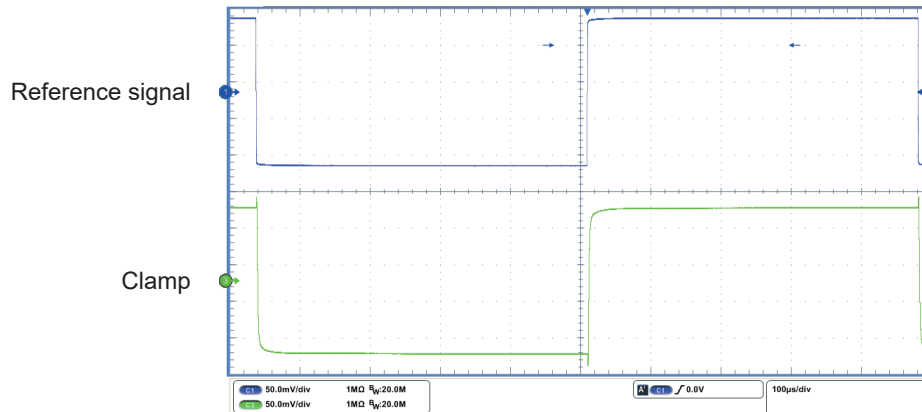

3.3. OPERATING LIMITS

- Conductor temperature: $\leq 90^{\circ}\text{C}$, 110°C peak
- Temperature of the jaws: $\leq 80^{\circ}\text{C}$
- Curve of derating versus frequency

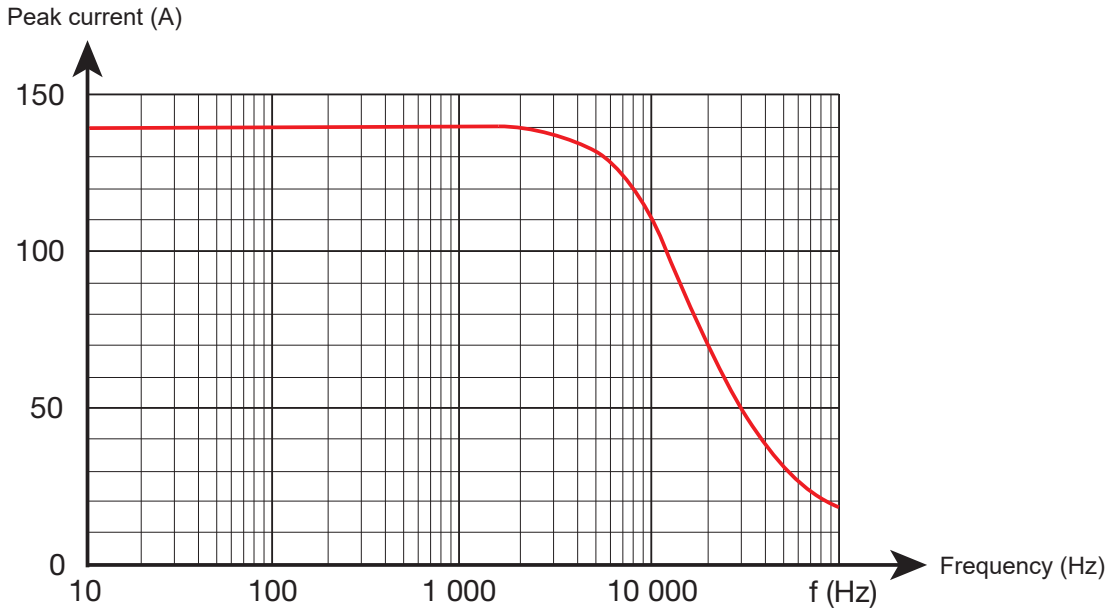

3.4. VARIATIONS IN THE RANGE OF USE

Quantity of influence	Range of influence	Error in % of reading	
		Typical	Maximum
Temperature	-10 to + 50 °C	Drift of the zero $\pm 10\text{mA}/^{\circ}\text{C}$	
			Drift of the gain $\pm 800\text{ppm}/^{\circ}\text{C}$
Relative humidity	0 to 85%RH		$\pm 0.5\%$
Frequency	1 to 100kHz		see curves
Position of conductor, 1kHz AC signal			$\pm 0.5\%$
Adjacent conductor	carrying a current of 10A at 60 Hz		$\pm 4\text{ mA/A}$
Common mode AC	Voltage at 400 Hz		$\pm 7\text{ mA}/100\text{ V}$
Remanence	for 100 A _{dc}	$\pm 450\text{ mAdc}$	
Immunity to 10V/m radiated field 100 mV/A range DC measurement	[80 MHz ;280 MHz] [460 MHz ;1 GHz]		400 mAdc
	[280 MHz;460 MHz]		2 A _{dc}

3.5. POWER SUPPLY

The instrument is powered by a 9V battery (type 6LR61 or NEDA 1604A).
The typical battery life is 80h with an alkaline battery.

The instrument can be powered by an external supply (5V_{dc}, 50mA) via the type B micro-USB connector.

3.6. ENVIRONMENTAL CONDITIONS

The device must be used in the following conditions:

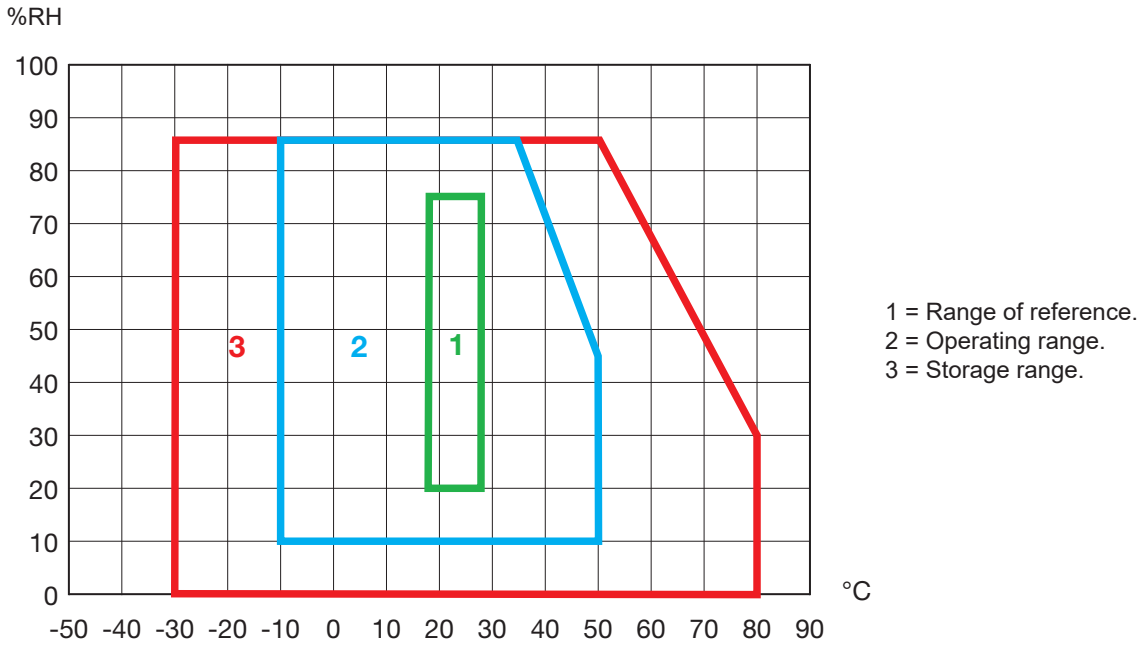

- Indoor use.
- Degree of pollution 2
- Altitude < 2000 m
- Transport altitude ≤ 12,000 m

3.7. CONSTRUCTION SPECIFICATIONS

- Dimensions (L x W x H) 231 x 36 x 67 mm
- Weight approximately 330 g
- Measurement lead 2 m long
- USB cord 15 cm long

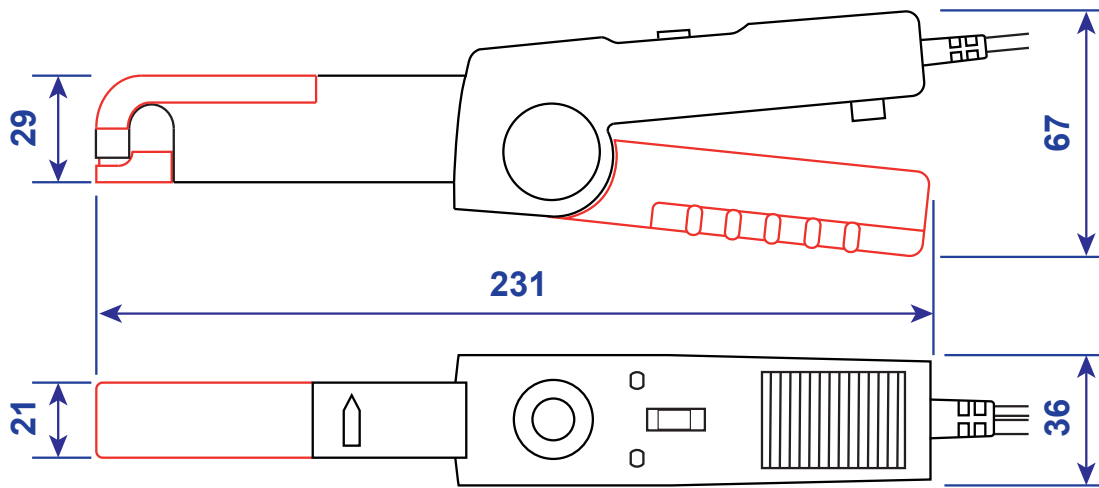

Clamping capacity: 11.8 mm in diameter

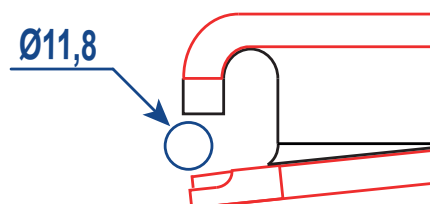



Protection by the housing

- IP 20 per IEC 60529
- Resistance of the jaws per IEC/EN 61010-2-032 or BS EN 61010-2-032

3.8. CONFORMITY TO INTERNATIONAL STANDARDS

The instrument is compliant with IEC/EN 61010-2-032 or BS EN 61010-2-032, 600 V in category III.

Double or reinforced insulation .

Type of current sensor per IEC/EN 61010-2-032 or BS EN 61010-2-032: type A .

3.9. ELECTROMAGNETIC COMPATIBILITY

The device is in conformity with standard IEC/EN 61326-1 or BS EN 61326-1.

4. MAINTENANCE



Except for the battery, the instrument contains no parts that can be replaced by personnel who have not been specially trained and accredited. Any unauthorized repair or replacement of a part by an "equivalent" may gravely impair safety.

4.1. CLEANING

Disconnect the instrument completely and turn the rotary switch to **OFF**. Also make sure that no cable is clamped.

Use a damp soft cloth and dry rapidly with a dry cloth or forced air. Do not use alcohol, solvents, or hydrocarbons.

The air gaps of the clamp must always be kept clean.

Do not leave the clamp in very damp places, or exposed to splashes.

4.2. REPLACING THE BATTERY

The battery must be replaced when the **On** indicator remains off when the device is switched on in the absence of an external supply.

- Withdraw the conductor from the clamp and disconnect it. Set the switch to **OFF**.
- use a screwdriver to unscrew the captive screw of the battery compartment cover then pull the cover out from the end of the mobile arm.
- Replace the spent battery with a new battery.



Spent primary and storage batteries must not be treated as ordinary household waste. Take them to the appropriate collection point for recycling.

- Place the battery in its compartment, with the correct polarity.
- Close the compartment and check that it is completely and correctly closed.
- Screw the screw back in.

4.3. MANUAL ADJUSTMENT

The manual adjustment serves to adjust the gain of the clamp without using a PC. To maintain good measurement accuracy, we recommend checking the clamp once a year.

4.3.1. EQUIPMENT NECESSARY

- A 200 Aac, 40 to 60 Hz current generator
- A 10 Aac, 60 Hz current generator, accuracy class $\leq 0.2\%$
- A 1 Aac, 60 Hz current generator, accuracy class $\leq 0.2\%$
- A voltmeter, accuracy class $\leq 0.2\%$

4.3.2. ADJUSTMENT PROCEDURE

1. First, demagnetize the clamp by clamping a conductor carrying an AC current of at least 200 ARMS at a frequency between 40 and 60Hz. Then gently withdraw the clamp from the conductor, in which the current is still flowing.
2. Place the clamp in a ambient temperature of $23\pm 2^{\circ}\text{C}$ for one hour. It must not be on a conductor, and the jaws must be correctly closed. Connect the voltmeter in VAC mode to the output of the clamp.
3. To enter the adjustment mode, hold the **DC Zero** button down and shift the switch from the **OFF** setting to the range to be adjusted (**10mV/A** or **100mV/A**). Keep the **DC Zero** button pressed for 30 seconds, until the **ON** indicator blinks orange, then green. Release the **DC Zero** button. The clamp is in the adjustment mode.
4. The clamp then performs an adjustment of the zero.

5. Clamp a conductor carrying a current of:
 - 10 AAC 60 Hz for the 10mV/A range
 - 1 AAC 60 Hz for the 100mV/A range
6. Then press the **DC Zero** button. The first press substantially lowers the polarization adjustment of Hall effect sensors. Subsequent presses increase this adjustment by one step. So press the **DC Zero** button until the correct output voltage is reached.
 - 100 mVRMS for the 10mV/A range.
 - 100 VRMS for the 100mV/A range.

If you overshoot this value, continue to press the **DC Zero** button until the output signal falls below the desired value, then restart the adjustment.

7. Once this adjustment is done, press the **DC Zero** button again for 30 seconds, until the **ON** indicator blinks orange, then green. You can then release the **DC Zero** button. The adjustment is recorded and the clamp exits from the adjustment mode.

Remarks

- When the clamp is in the adjustment mode (in other words, from step 3), any change of the switch setting causes an exit from the adjustment mode with no modification. The clamp will then use the previous adjustments.
- To adjust both ranges, you must switch the clamp off, then repeat the adjustment procedure from step 3.

5. WARRANTY

Except as otherwise stated, our warranty is valid for **24 months** starting from the date on which the equipment was sold. Extract from our General Conditions of Sale provided on request.

The warranty does not apply in the following cases:

- Inappropriate use of the equipment or use with incompatible equipment.
- Modifications made to the equipment without the explicit permission of the manufacturer's technical staff.
- Work done on the device by a person not approved by the manufacturer.
- Adaptation to a particular application not anticipated in the definition of the equipment or not indicated in the user's manual.
- Damage caused by shocks, falls, or floods.

