

# C.A 6131 C.A 6133











## Installation testers

*Measure up*



Thank you for purchasing a **C.A 6131 or C.A 6133 installation tester**.

- To obtain the best service from your instrument:
- **read** this user manual carefully,
- **comply** with the precautions for use.

	WARNING, risk of DANGER! The operator must refer to these instructions whenever this danger symbol appears.
	WARNING, risk of electric shock. The voltage applied to parts marked with this symbol may be hazardous.
	Useful information or tip.
	 Earth.
	The voltage on the terminals must not exceed 550 V.
	The product is declared recyclable following a life cycle analysis in accordance with standard ISO 14040.
	The CE marking indicates compliance with the European Low Voltage Directive (2014/35/EU), Electromagnetic Compatibility Directive (2014/30/EU), and Restriction of Hazardous Substances Directive (RoHS, 2011/65/EU and 2015/863/EU).
	Chauvin Arnoux has adopted an Eco-Design approach in order to design this appliance. Analysis of the complete life-cycle has enabled us to control and optimize the effects of the product on the environment. In particular this appliance exceeds regulation requirements with respect to recycling and reuse.
	The rubbish bin with a line through it indicates that, in the European Union, the product must undergo selective disposal in compliance with Directive WEEE 2012/19/EU. This equipment must not be treated as household waste.

#### Definition of measurement categories

- Measurement category IV corresponds to measurements taken at the source of low-voltage installations.  
Example: power feeders, counters and protection devices.
- Measurement category III corresponds to measurements on building installations.  
Example: distribution panel, circuit-breakers, machines or fixed industrial devices.
- Measurement category II corresponds to measurements taken on circuits directly connected to low-voltage installations.  
Example: power supply to electro-domestic devices and portable tools.

## PRECAUTIONS FOR USE

This instrument is compliant with safety standard IEC/EN 61010-2-034 or BS EN 61010-2-034, the leads are compliant with IEC/EN 61010-031 or BS EN 61010-031, and the current sensors are compliant with IEC/EN 61010-2-032 or BS EN 61010-2-032, for voltages up to 600V in category III.

Do not use the instrument for measurements on circuits that are not in measurement categories II, III, or IV or that might be connected inadvertently to circuits that are not in measurement categories II, III, or IV.

- The operator and/or the responsible authority must carefully read and clearly understand the various precautions to be taken in use. Sound knowledge and a keen awareness of electrical hazards are essential when using this instrument.
- If you use this instrument other than as specified, the protection it provides may be compromised, thereby endangering you.
- Do not use the instrument on networks of which the voltage or category exceeds those mentioned.
- Do not use the instrument if it seems to be damaged, incomplete, or poorly closed.
- Before each use, check the condition of the insulation on the leads, housing, and accessories. Any item of which the insulation is deteriorated (even partially) must be set aside for repair or scrapping.
- Before using your instrument, check that it is perfectly dry. If it is wet, it must be thoroughly dried before it can be connected or used.
- Use only the leads and accessories supplied. The use of leads (or accessories) of a lower voltage or category limits the voltage or category of the combined instrument and leads (or accessories) to that of the leads (or accessories).
- Use personal protection equipment systematically.
- When handling the leads, test probes, and crocodile clips, keep your fingers behind the physical guard.
- All troubleshooting and metrological checks must be performed by competent and accredited personnel.

# CONTENTS

<b>1. FIRST START-UP</b> .....	<b>4</b>
1.1. Unpacking.....	4
1.2. Accessories .....	4
1.3. Inserting the batteries .....	5
1.4. Primary batteries in the C.A 6133 or rechargeable batteries in the C.A 6131 .....	6
1.5. Charging the battery (C.A 6133).....	6
1.6. Carrying the device.....	7
1.7. Use on a desktop.....	7
<b>2. PRESENTATION OF THE DEVICES</b> .....	<b>8</b>
2.1. C.A 6131.....	8
2.2. C.A 6133.....	9
2.3. Functions of the instruments .....	10
2.4. Keys of the C.A 6131 .....	10
2.5. Keys of the C.A 6133.....	11
2.6. Display unit .....	12
<b>3. USE</b> .....	<b>13</b>
3.1. Voltage measurement.....	13
3.2. Resistance and continuity measurement.....	15
3.3. Insulation resistance measurement.....	17
3.4. 3P earth resistance measurement (C.A 6133) .....	19
3.5. Loop or line impedance measurement .....	22
3.6. Test of residual current device .....	26
3.7. Current measurement.....	30
3.8. Direction of phase rotation.....	32
3.9. Auto RCD function (C.A 6133).....	33
3.10. Auto LOOP RCD MΩ function (C.A 6133) .....	34
<b>4. MEMORY FUNCTION (C.A 6133)</b> .....	<b>35</b>
4.1. Organization of the memory .....	35
4.2. Storing measurements .....	35
4.3. Reading the measurements .....	35
4.4. Erasing measurements.....	36
<b>5. BLUETOOTH LINK (C.A 6133)</b> .....	<b>37</b>
<b>6. TECHNICAL CHARACTERISTICS</b> .....	<b>38</b>
6.1. General reference conditions .....	38
6.2. Electrical characteristics .....	38
6.3. Variations in the range of use .....	44
6.4. Intrinsic uncertainty and operating uncertainty .....	46
6.5. Power supply .....	46
6.6. Environmental conditions .....	47
6.7. Bluetooth link (C.A 6133).....	47
6.8. Mechanical characteristics .....	48
6.9. Conformity to international standards.....	48
6.10. Electromagnetic compatibility (CEM).....	48
<b>7. MAINTENANCE</b> .....	<b>49</b>
7.1. Cleaning .....	49
7.2. Replacing the batteries.....	49
7.3. Updating of the internal software.....	49
7.4. Calibrating the instrument.....	50
<b>8. WARRANTY</b> .....	<b>54</b>

# 1. FIRST START-UP

## 1.1. UNPACKING

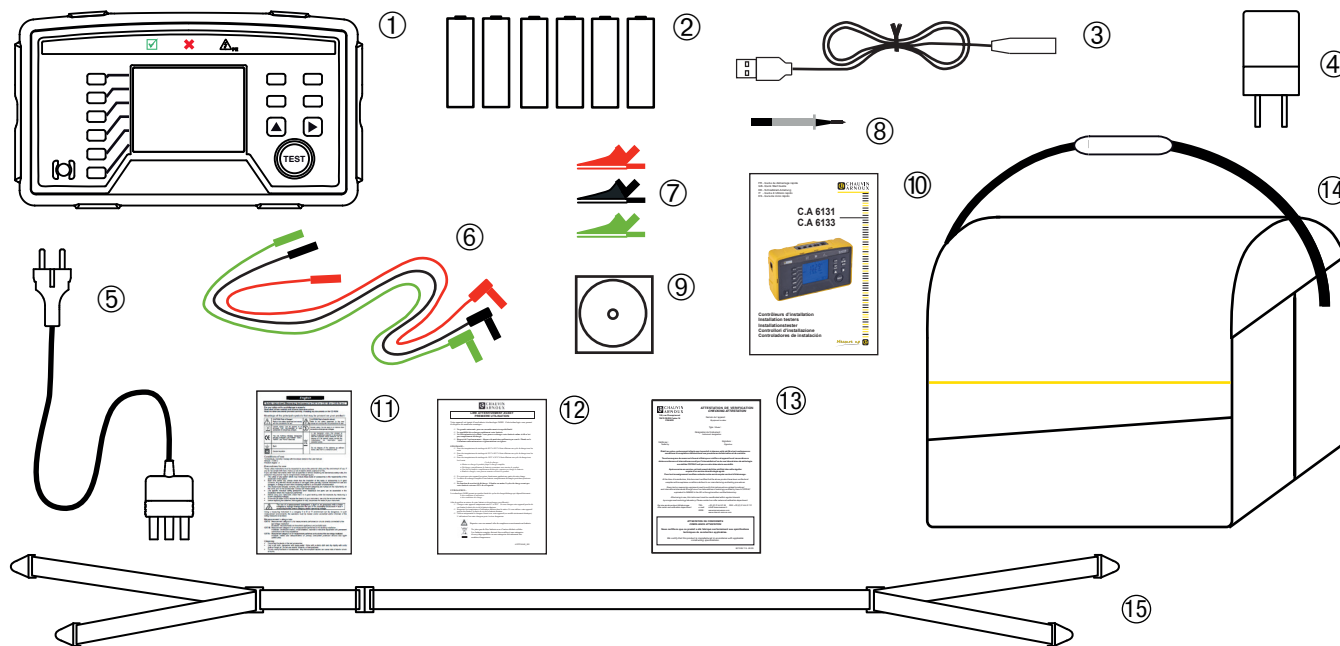

- ① One C.A 6131 or C.A 6133.
- ② 6 LR6 or AA primary batteries for the C.A 6131; 6 rechargeable Ni-MH batteries for the C.A 6133.
- ③ One shaver USB cable for the C.A 6133.
- ④ One mains USB adapter (5V, 2A) for the C.A 6133.
- ⑤ One tripod cable with mains plug (of the type used in the country of sale).
- ⑥ Three elbow-straight safety cables (red, black, and green).
- ⑦ Three crocodile clips (red, black, and green).
- ⑧ One black probe tip.
- ⑨ One user manual on CD-ROM (1 file per language).
- ⑩ One multilingual quick start guide.
- ⑪ One multilingual safety data sheet.
- ⑫ One battery data sheet for the C.A 6133.
- ⑬ One test report.
- ⑭ One carrying bag.
- ⑮ One 4-point hands-free strap.

## 1.2. ACCESSORIES

No. 4 remote control probe  
MN73A 2A/200A current clamp

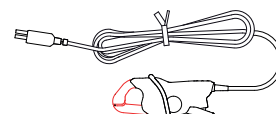
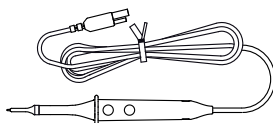

For the accessories and spares, consult our web site:  
[www.chauvin-arnoux.com](http://www.chauvin-arnoux.com)

### 1.3. INSERTING THE BATTERIES

- Open the battery compartment cover. Place your fingers on either side of the cover, insert a tool in the latching system, and lever up.

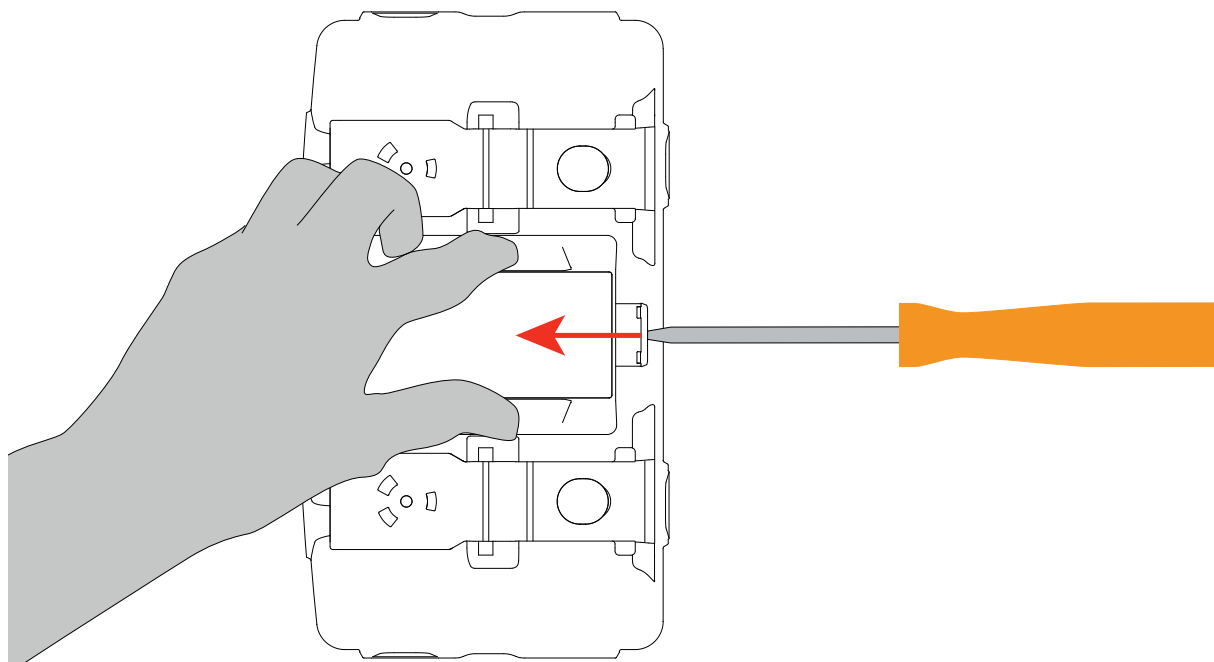

- Remove the battery compartment cover, then raise the rubber plug.

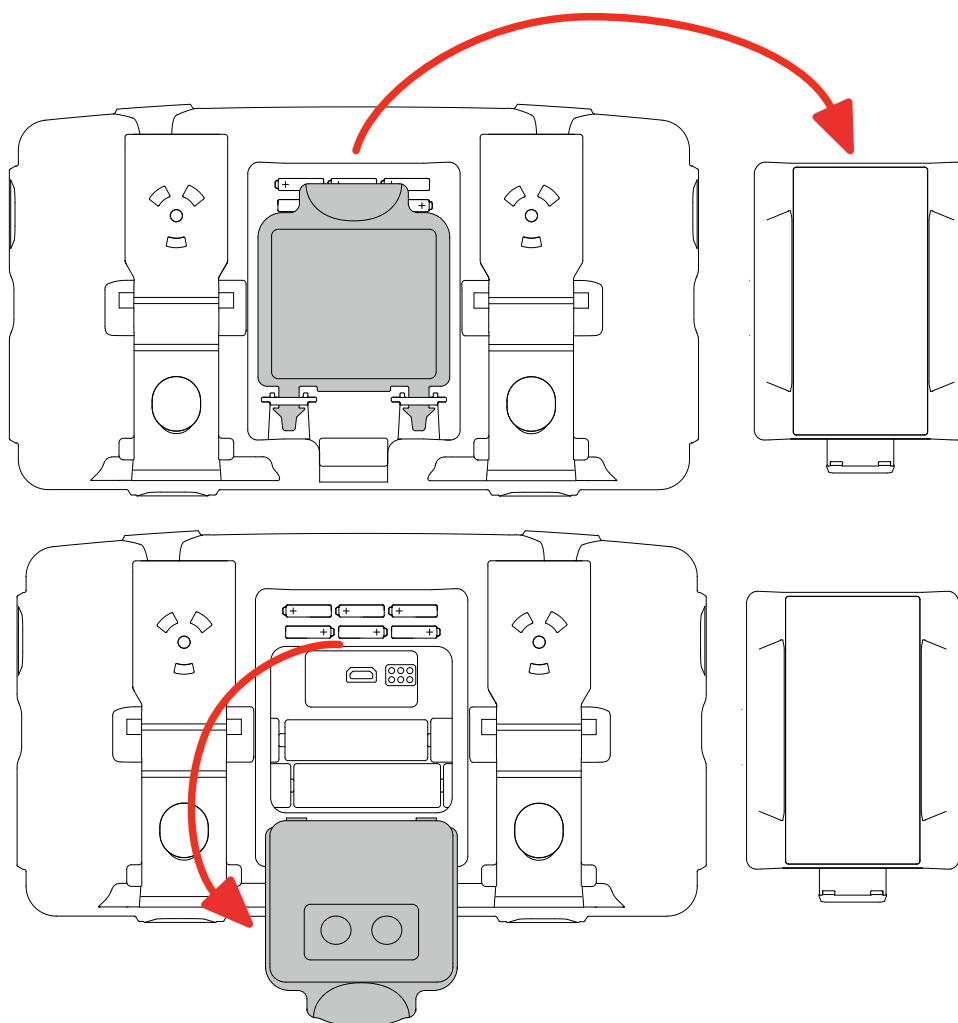

- Insert the 6 primary batteries provided (C.A 6131) or the 6 rechargeable batteries (C.A 6133), with the polarities as indicated.
- Put the rubber plug back in place. Push it in correctly.
- Put the battery compartment cover back in place; make sure that it is completely and correctly closed.

### 1.4. PRIMARY BATTERIES IN THE C.A 6133 OR RECHARGEABLE BATTERIES IN THE C.A 6131

If you prefer to use primary batteries in your C.A 6133 or rechargeable batteries in your C.A 6131, you must parameterize your instrument so that it indicates the correct charge level. The primary batteries deliver a higher voltage than the rechargeable batteries.

- Insert batteries (primary or rechargeable) in your instrument as indicated above.



- Press the **On/Off** button to switch the instrument on. It starts up in voltage measurement mode (●V).



- Long press the ► key.  
The instrument displays **bAtt** to indicate that it is configured for operation with primary batteries.  
Or **bAtt rECH** to indicate that it is configured for operation with rechargeable batteries.

### 1.5. CHARGING THE BATTERY (C.A 6133)

Before the first use, start by fully charging the battery. The charging must be done between 0 and 45°C.

**i** Do not charge if there are primary batteries in the instrument.

- Connect one end of the shaver USB cable (provided) to the terminal block of the C.A 6133 and the other end to a wall outlet using the mains-USB adapter (provided).

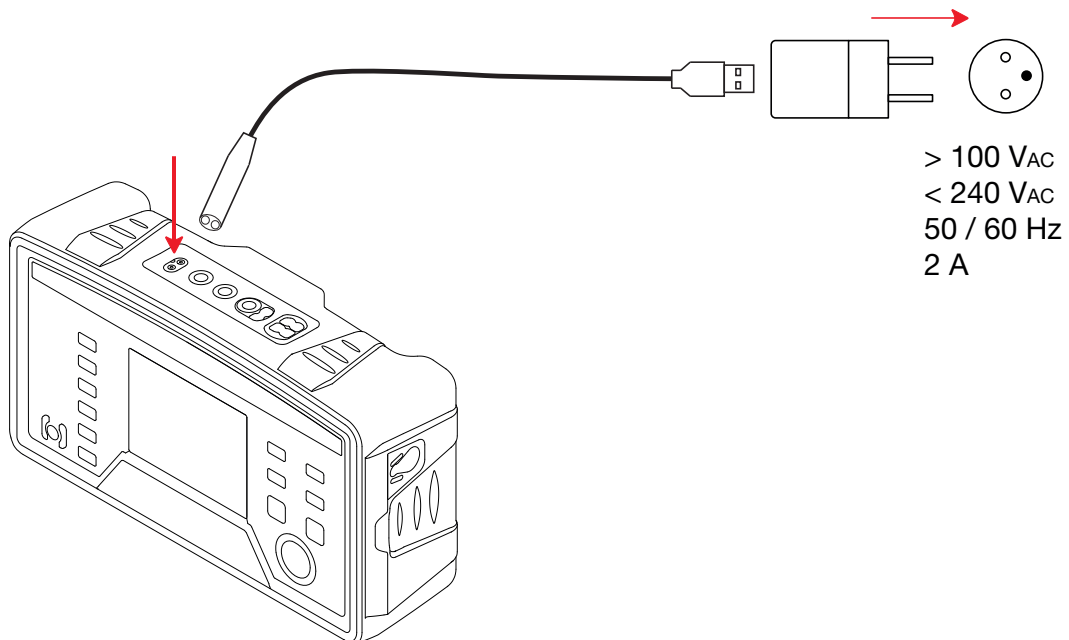

- The instrument is switched on and the display unit indicates the progress of the charging.



Charging takes approximately 6 hours.

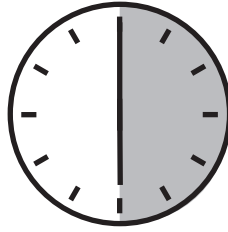

- Once charging is over, disconnect the plug. The instrument is ready to be used.

## 1.6. CARRYING THE DEVICE

- The 4-point hands-free strap will let you use the device while leaving your hands free. Snap the four fasteners of the strap onto the four lugs on the device.

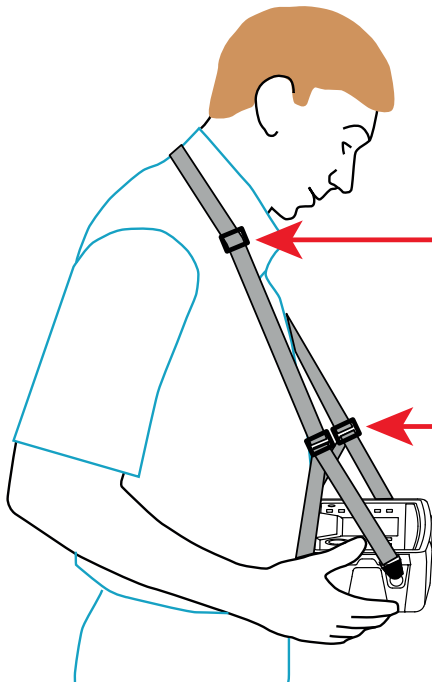

- Pass the strap around your neck.
- Adjust the length of the strap,
- Adjust the slope of the instrument.

## 1.7. USE ON A DESKTOP

Pull the props out, then fold them and put them in the other location.

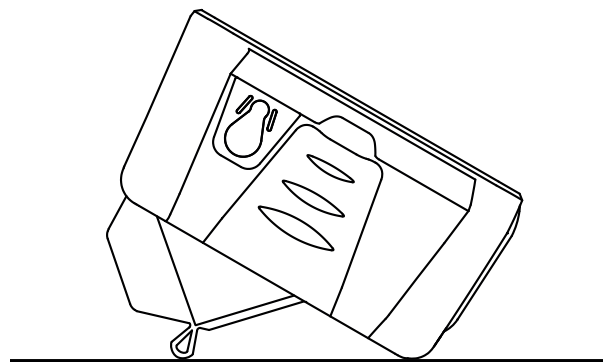
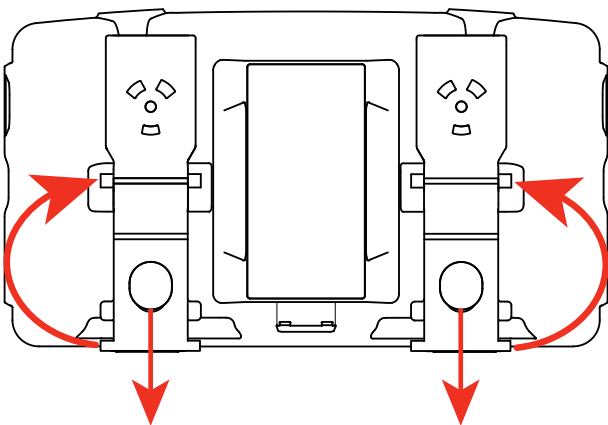

# 2. PRESENTATION OF THE DEVICES

## 2.1. C.A 6131

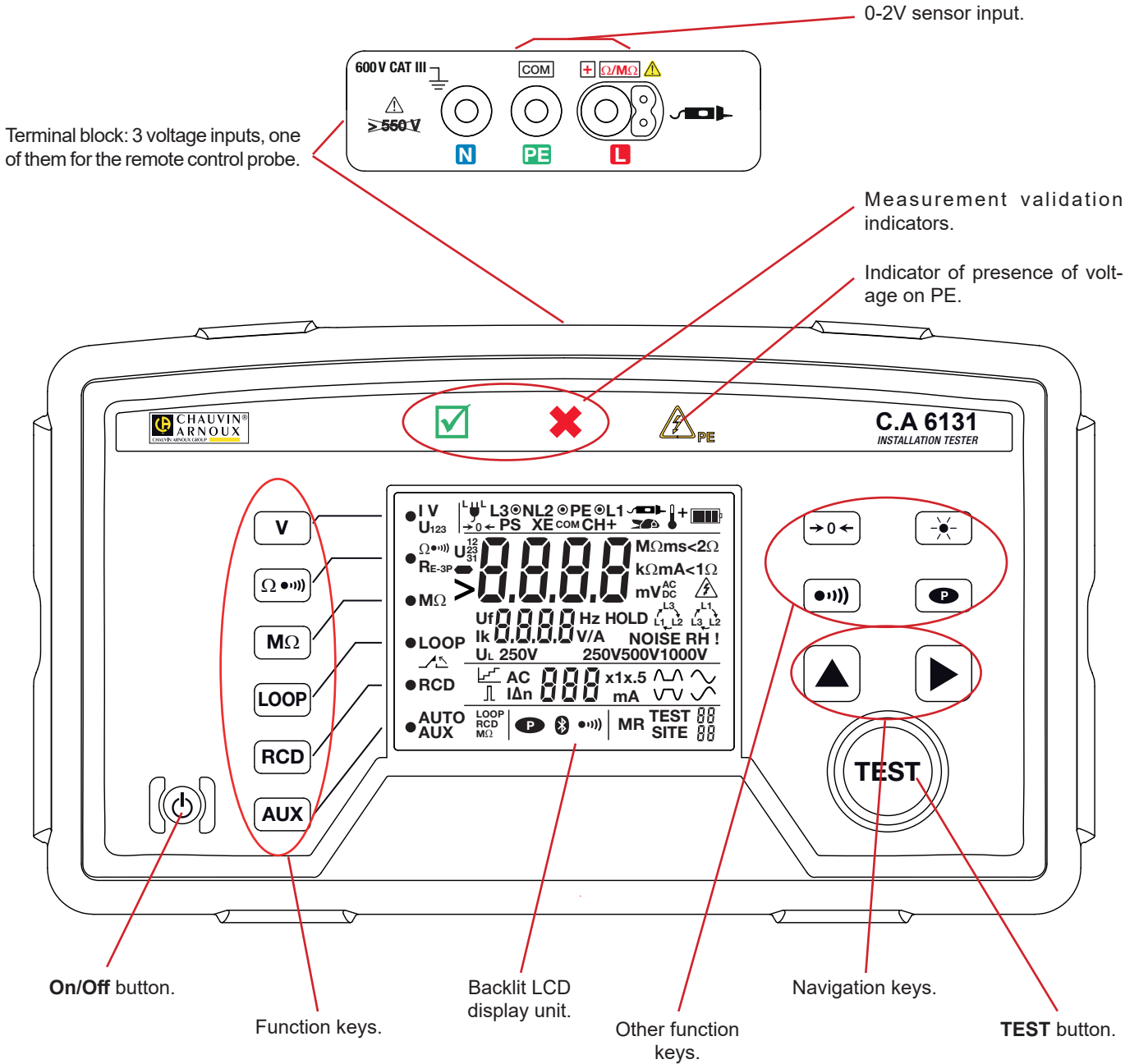



## 2.2. C.A 6133

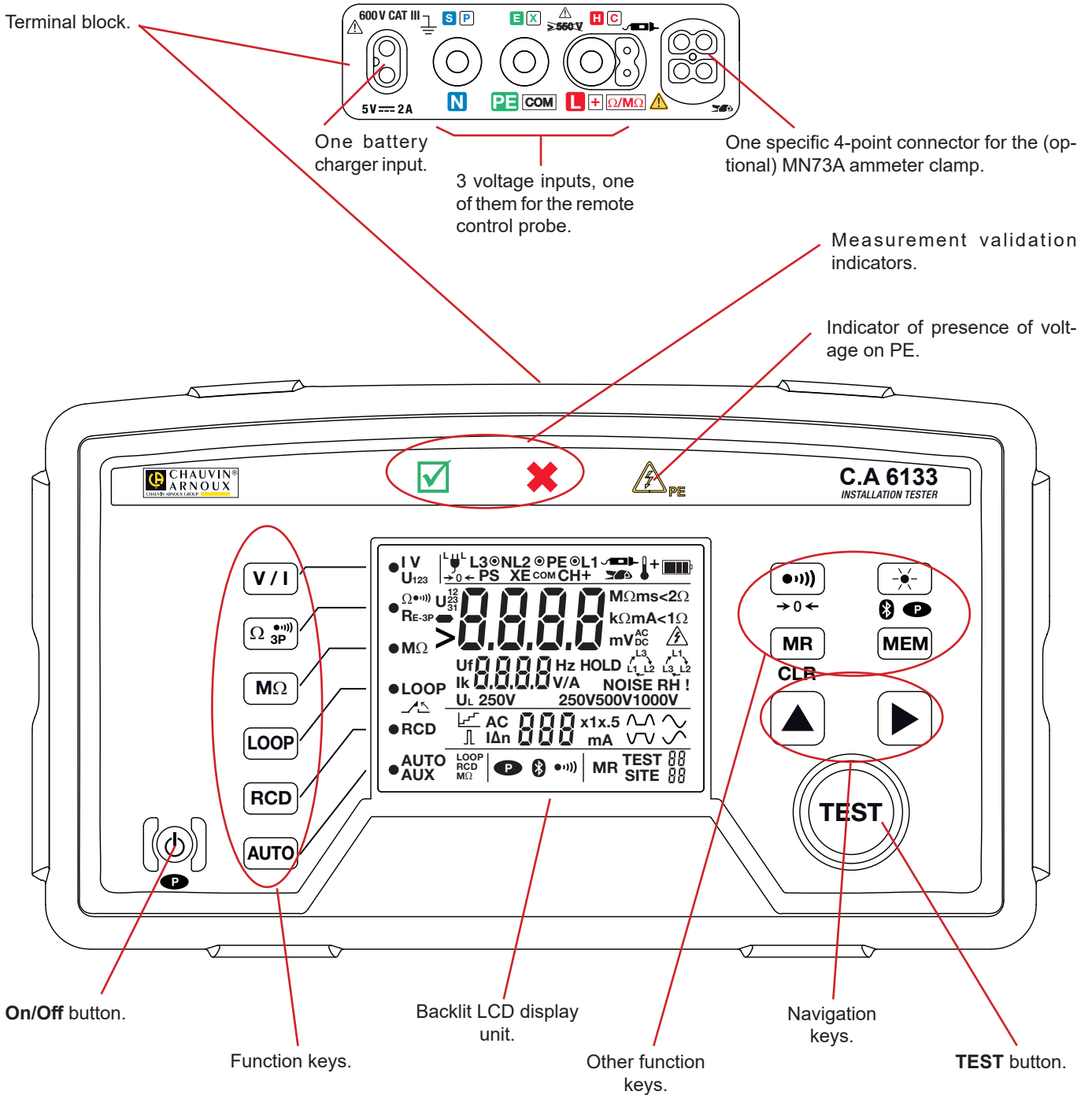

## 2.3. FUNCTIONS OF THE INSTRUMENTS

C.A 6131 and C.A 6133 installation testers are portable measuring instruments with LCD displays. They are powered by batteries. They can both be powered by rechargeable batteries, but only the C.A 6133 can recharge them.

These instruments are used to check the safety of electrical installations. It can be used to test a new installation before it is powered up, to check an existing installation, whether in operation or not, or to diagnose a malfunction in an installation.



	C.A 6131	C.A 6133
Voltage measurement	✓	✓
Continuity and resistance measurement	✓	✓
Insulation resistance measurement	250V - 500V	250V - 500V – 1.000V
Earth resistance measurement (with 3 rods)	✗	✓
Loop or line impedance measurement	✓	✓
Test of type AC, A, F, B, B+ and EV residual current devices, in ramp mode, in pulse mode, or in non-tripping mode	✓	✓
Detection of direction of phase rotation	✓	✓
Current measurement on a 0-2V input sensor	✓	✗
Current measurement with an optional current clamp	✗	✓
Storage of the measurements	✗	✓
Bluetooth	✗	✓
Self-test	✗	✓

## 2.4. KEYS OF THE C.A 6131



To prevent inadvertent switching on of the instrument, the **On/Off** button is protected by two ribs on the housing.

Button	Function
	Pressing the <b>On/Off</b> button switches the instrument on. Pressing it again switches it off.
<b>TEST</b>	Pressing the <b>TEST</b> button starts insulation or loop measurements or RCD tests.



Key	Function
<b>V</b>	Press the key once to make voltage measurements. Press again to determine the phase order.
<b>Ω ●)))</b>	Press the key once to make continuity measurements. Press again to make resistance measurements.
<b>MΩ</b>	Press the key once to enter the insulation measurement function.
<b>LOOP</b>	Press the key once to enter the loop measurement function in no-trip mode. Press again to enter the loop measurement function in trip mode.
<b>RCD</b>	Press the key once to enter the RCD test function in no-trip mode. Press again to enter the RCD test function in ramp mode. Press a third time to enter the RCD test function in pulse mode.
<b>AUX</b>	Press the key once to make measurements on the 0-2V sensor input.

Key	Function
→ 0 ←	A sustained press serves to compensate the resistance of the leads.
	Press the key once to switch the backlighting on for one minute. Pressing it again switches it off.
	Press the key once to deactivate the audible signal emitted by the instrument. Press again to reactivate it.
	Press this key to deactivate auto-off. The instrument then operates in permanent mode. Press again to exit from permanent mode.
▲ and ►	The ▲ and ► keys are used to parameterize the measurements.

## 2.5. KEYS OF THE C.A 6133

Button	Function
	Pressing the <b>On/Off</b> button switches the instrument on. Pressing it again switches it off.  If the  key is pressed during starting up, auto-off is deactivated. The instrument then operates in permanent mode.
<b>TEST</b>	Pressing the <b>TEST</b> button starts insulation or loop measurements or RCD tests, and measurements in automatic mode.

Key	Function
V / I	Press the key once to make voltage measurements. If an ammeter clamp is connected, the instrument will make current measurements. Press again to determine the phase order.
$\Omega$  3P	Press the key once to make continuity measurements. Press again to make resistance measurements. A third press is used to make 3P earth measurements.
<b>M<math>\Omega</math></b>	Press the key once to enter the insulation measurement function.
<b>LOOP</b>	Press the key once to enter the loop measurement function in no-trip mode. Press again to enter the loop measurement function in trip mode.
<b>RCD</b>	Press the key once to enter the RCD test function in no-trip mode. Press again to enter the RCD test function in ramp mode. Press a third time to enter the RCD test function in pulse mode.
<b>AUTO</b>	Press the key once to enter the RCD test function in automatic mode. Press again to enter the installation test function in automatic mode.

Key	Function
	<p>Press the key once to deactivate the audible signal emitted by the instrument. Press again to reactivate it.</p> <p>A sustained press serves to compensate the resistance of the leads.</p>
	<p>Press the key once to switch on the backlighting. Pressing it again switches it off.</p> <p>A long press on the key activates the Bluetooth link. A second long press deactivates it.</p>
<b>MR</b> <b>CLEAR</b>	<p>Press the key once to read the recorded measurements. A long press erases all of the recorded data.</p>
<b>MEM</b>	<p>Press the key once to record the last measurement made/displayed in the same site, in the next test number. A long press records the last measurement made/displayed in another site, at the lowest available test number.</p>
<b>▲ and ►</b>	<p>The ▲ and ► keys are used:</p> <ul style="list-style-type: none"> <li>■ to parameterize the measurements,</li> <li>■ to browse while reading the memory.</li> </ul>

## 2.6. DISPLAY UNIT

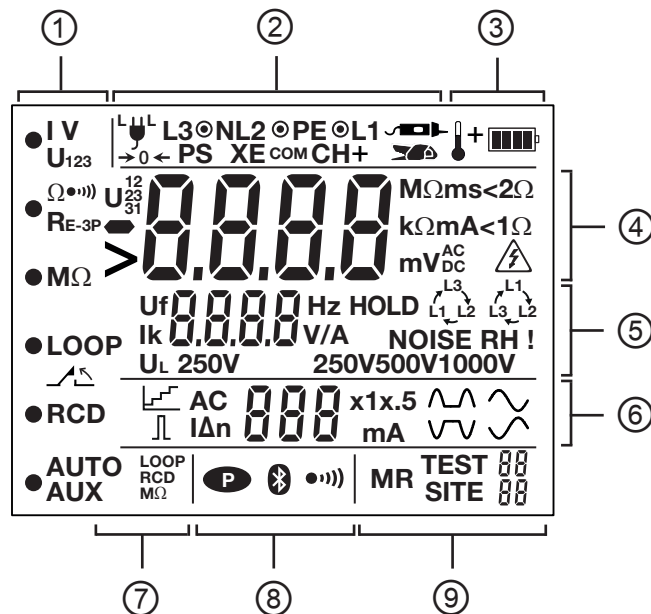

- |  |   |
|--|---|
| ① Indicates the measurement in progress                                    | ⑥ Parameters of the RCD function            |
| ② Indicates the connections  | ⑦ Parameters of the AUTO function           |
| ③ Indicates the state of the battery and the temperature of the instrument | ⑧ Display linked to the other function keys |
| ④ Main display   | ⑨ Display linked to the recording function  |
| ⑤ Secondary display  |   |

# 3. USE

## 3.1. VOLTAGE MEASUREMENT

### 3.1.1. DESCRIPTION OF THE MEASUREMENT PRINCIPLE

The device separates the alternating voltage from the direct voltage and compares the amplitudes to decide whether the signal is AC or DC. In the case of an AC signal, the frequency is measured and the instrument calculates and displays the RMS value of the signal (AC + DC). In the case of a DC signal, the device does not measure its frequency, but calculates its mean value and displays it.

For measurements made at the mains voltage, the device checks that the connection is correct and displays the position of the phase on the socket outlet. It also verifies the presence of a protection conductor on the PE terminal thanks to the contact the user makes with their hands when holding the instrument, or with their stomach when the instrument is slung on the strap, or with the floor when it is set down.

### 3.1.2. MAKING A MEASUREMENT



Press the **On/Off** button to switch the instrument on.  
The instrument starts up in voltage measurement mode (●V).

Connect one end of the tripod cable to the measurement terminals and the other end to the object to be measured.

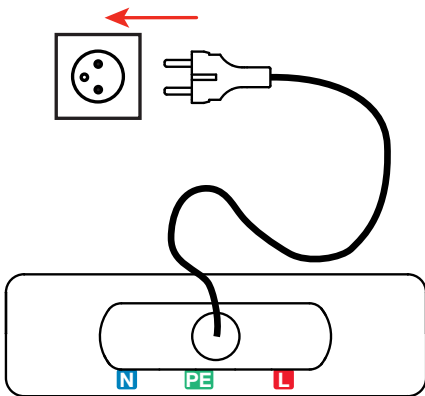



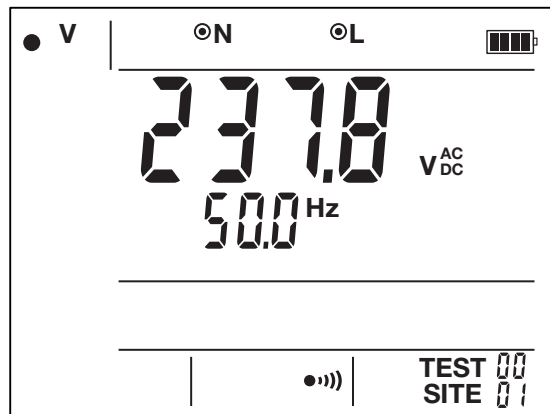

The measurement is displayed. The instrument indicates that it is making the measurement between the L and N terminals. It is therefore possible to make the measurement with two leads.  
Only the C.A 6133 displays the frequency.

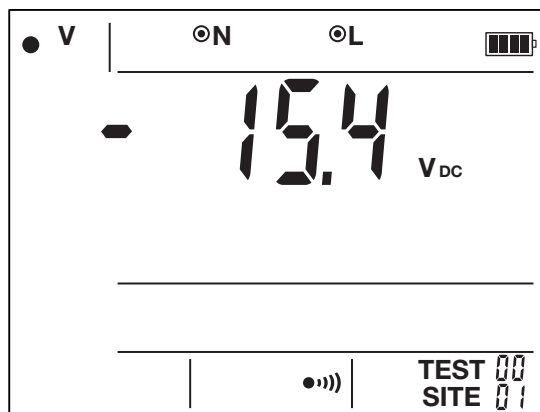

The instrument indicates whether the voltage is AC or DC.

- If the voltage is AC, the C.A 6133 displays its frequency.
- If the voltage is DC, the instrument also indicates its polarity.



In the case of a live measurement (LOOP or RCD), the instrument shows where the phase should be on the outlet using the  symbol. If the phase is on the wrong side, the  or  symbol blinks to indicate that the tripod cable must be reversed.

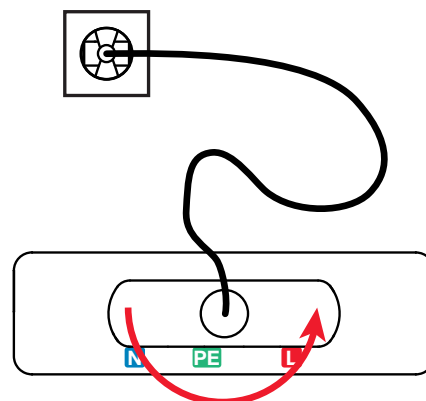
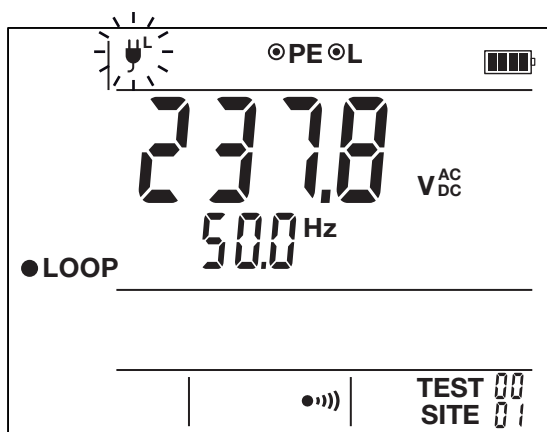

### 3.1.3. CHECKING THE OPERATION OF THE INSTRUMENT



Before each use of the instrument, check its operation by making a voltage measurement on a known voltage. If the measurement is incorrect, do not use the instrument.

### 3.1.4. ERROR INDICATION

- If the measurement is outside the measurement range, in either voltage or frequency, the instrument so indicates.
- If the voltage is less than 2V, the C.A 6133 cannot measure its frequency and displays - - -.

## 3.2. RESISTANCE AND CONTINUITY MEASUREMENT

### 3.2.1. DESCRIPTION OF THE MEASUREMENT PRINCIPLE

For continuity measurements, the instrument generates a 200mA direct current between the **+** and **COM** terminals. It then measures the voltage present between these two terminals and from it deduces the value of  $R = V/I$ .

For resistance measurements, the device generates a DC voltage between the **+** and **COM** terminals. It then measures the current between these two terminals and from it deduces the value of  $R = V/I$ .



### 3.2.2. MAKING A CONTINUITY MEASUREMENT

To comply with the IEC 61557 standard, continuity measurements must be made with a positive current, then with a negative current. The 2 measurements must then be averaged. The reversal of the current serves to compensate for any residual electromotive forces and, more important, to check that the continuity is in fact duplex.

When you make continuity measurements that are not contractual, you are not required to reverse the polarity or calculate the average.

 Turning the tripod connector around does not reverse the current.



Press the  $\Omega$   3P key to select the  $\bullet\Omega$   function.



- Connect the leads between the **+** and **COM** terminals, short-circuit them, and compensate them by a sustained press on the  $\rightarrow 0 \leftarrow$  key until the display unit indicates **StAb**. You can then release the  $\rightarrow 0 \leftarrow$  key and the display unit indicates 0.00. The compensation of the leads is preserved until the instrument is switched off.

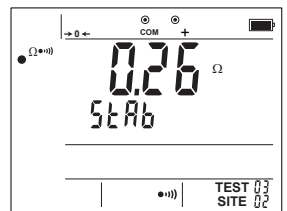
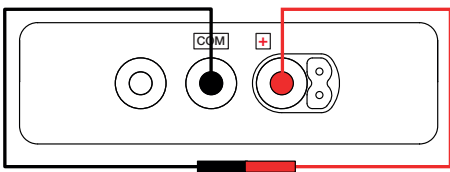

- Choose the 1Ω or 2Ω continuity threshold by a long press on the  $\blacktriangleright$  key.

Use the leads to connect the device to be tested to the **+** and **COM** terminals of the instrument.

 The object to be tested must not be live.

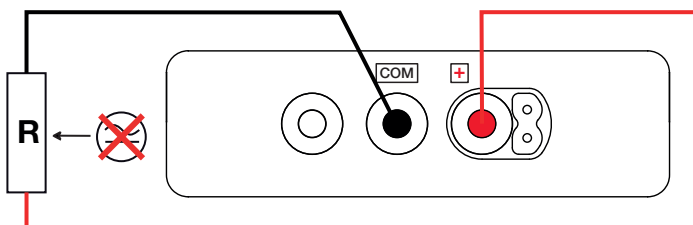

The measurement is displayed.

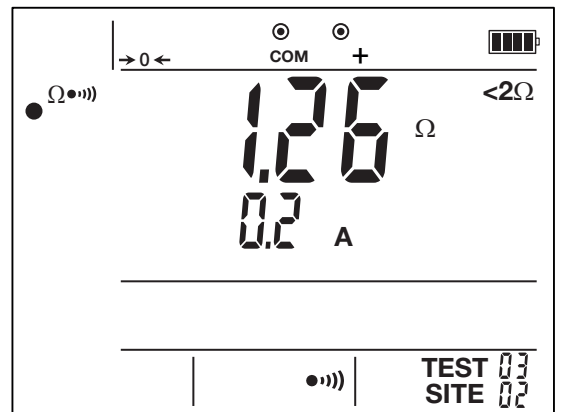



For as long as the measurement varies between some value and **OL**, the instrument remains on even if not in permanent mode

**P**



### 3.2.3. VALIDATION OF THE MEASUREMENT

The instrument then indicates whether or not the measured value is OK:

- If the measured value is less than the threshold (1Ω or 2Ω), the  indicator lights and the instrument emits a continuous audible signal.
- If the measurement is between the threshold (1Ω or 2Ω) and 10Ω, the  indicator lights.
- If the measurement is greater than 10Ω, the instrument so indicates by displaying > 9.99Ω.
- If a spurious voltage appears during the measurement, the  symbol is displayed, the instrument emits a continuous audible signal, and the measurement is aborted.

### 3.2.4. MAKING A RESISTANCE MEASUREMENT



Press the  3P key a second time to select the  Ω function.



Use the leads to connect the device to be tested to the + and COM terminals of the instrument.



The object to be tested must not be live.

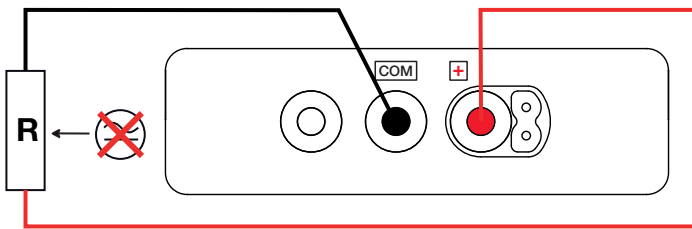

The measurement is displayed.

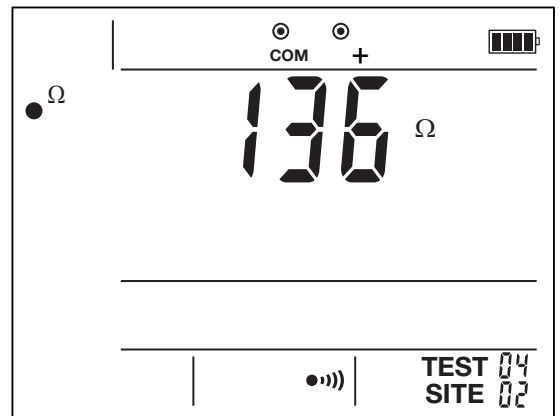

### 3.2.5. ERROR INDICATION

- If the measurement is outside the measurement range, the instrument so indicates by displaying >99.99kΩ.
- If a spurious voltage appears during the measurement, the  symbol is displayed and the measurement is aborted.

### 3.2.6. REMOTE CONTROL PROBE

The optional no. 4 remote control probe is used to remote the + terminal. When it is connected to the instrument, the  symbol is displayed.

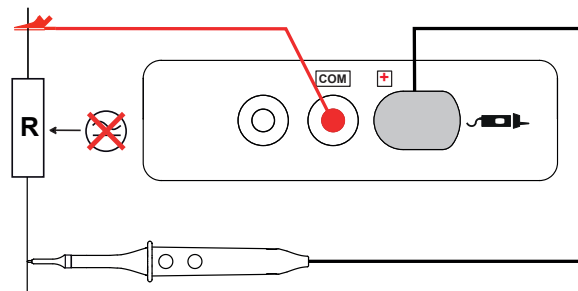

For the use of the no. 4 remote control probe, refer to its user's manual.



### 3.3. INSULATION RESISTANCE MEASUREMENT

#### 3.3.1. DESCRIPTION OF THE MEASUREMENT PRINCIPLE

The device generates a DC test voltage between the **+** and **COM** terminals. The value of this voltage depends on the resistance to be measured: it is greater than or equal to  $U_N$  when  $R \geq R_N = U_N / 1 \text{ mA}$ , and less otherwise. The device measures the voltage and current present between the two terminals and from them deduces the value of  $R = V / I$ . The **COM** terminal is the voltage reference point and the **+** terminal delivers a positive voltage.

#### 3.3.2. MAKING A MEASUREMENT



Press the **MΩ** key to select the **• MΩ** function. The instrument is set to voltage measurement.



- Select the nominal test voltage  $U_N$ : 250, 500, or 1000 V (C.A 6133 only), by pressing the **▶** key.
- Select the alarm threshold of the NF C 61557 (NFC) or IEC 61557 (CEI) standard or no threshold (OFF) by a long press on the **▲** key.

Thresholds for various standards and test voltages.

	NF C	CEI
<b>250V</b>	250kΩ	0.5MΩ
<b>500V</b>	500kΩ	1MΩ
<b>1000V</b>	1MΩ	1MΩ

If the alarm is activated, it can serve to inform the user, by an audible signal, that the measurement exceeds the threshold, with no need to look at the display unit.

- Use the leads to connect the device to be tested to the **+** and **COM** terminals of the instrument.



The object to be tested must not be live.

- Press the **TEST** button and keep it pressed until the measurement is stable. The symbol indicates that the instrument is generating a hazardous voltage.

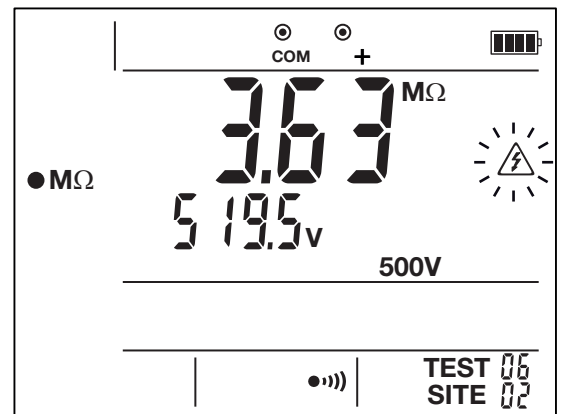
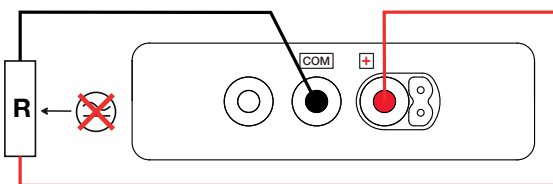

When you release the **TEST** button, the instrument displays **dis** (discharge) to indicate that it is discharging the object tested. If the object is not capacitive, discharging is very rapid. When the voltage falls below 25V, the **dis** and symbols disappear from the display unit.





Do not disconnect the instrument while the **dis** symbol is still displayed.



The measurement remains frozen until you press the **TEST** button. The instrument then returns to voltage measurement.

### 3.3.3. VALIDATION OF THE MEASUREMENT

If an alarm threshold is selected, the instrument informs you whether the measured value is OK or not:

- If the measured value is greater than the threshold, the  indicator lights.
- If the measured value is below the threshold, the  indicator lights.

### 3.3.4. ERROR INDICATION

- If the measured value is outside the measurement range, the instrument so indicates.
- If the object to be tested is live, the  symbol is displayed; the **TEST** button cannot be pressed.
- If a spurious voltage appears during the measurement, the  symbol is displayed and the measurement is aborted.

### 3.3.5. REMOTE CONTROL PROBE

The optional no. 4 remote control probe makes it easier to trigger the measurement, thanks to its remoted **TEST** button. When it is connected to the instrument, the  symbol is displayed.

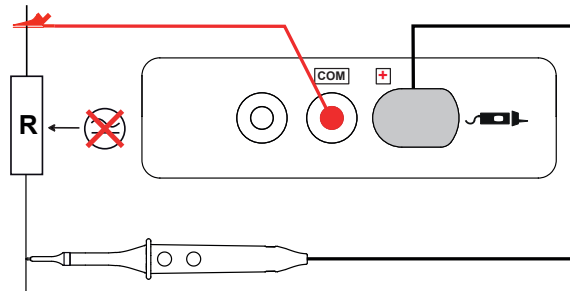

For the use of the no. 4 remote control probe, refer to its user's manual.

### 3.4. 3P EARTH RESISTANCE MEASUREMENT (C.A 6133)

This function is used to measure an earth resistance when the electrical installation to be tested is not live (new installation, for example). It uses two auxiliary rods, with the third rod being constituted by the earth electrode to be tested (whence the name "3P").

It can be used on an existing electrical installation, but the power must be cut off (main RCD). In all cases, new or existing installation, the earthing strip of the installation must be open during the measurement.

#### 3.4.1. DESCRIPTION OF THE MEASUREMENT PRINCIPLE

The device generates between the H and E terminals a square wave at a frequency of 128 Hz and an amplitude of 35 V. It measures the resulting current,  $I_{HE}$ , along with the voltage present between the S and E terminals,  $U_{SE}$ . It then calculates the value of  $R_E = U_{SE} / I_{HE}$ .

#### 3.4.2. DESIGNATIONS OF THE TERMINALS

It is possible to change the names of the terminals in a 3P earth measurement from H S E to C P X. To do this, when you are in the 3P function, long-press the ► key.

#### 3.4.3. MAKING A MEASUREMENT

There are several measurement methods. We recommend the «62%» method.



Press the  $\Omega$  ●))) 3P key three times to select the ●  $R_{E-3P}$  function.



- Connect the leads between the H, S and E terminals, short-circuit them, and compensate the measurement leads by a sustained press on the ► 0 ◀ key, until the display unit indicates **StAb**. You can then release the ► 0 ◀ key and the display unit indicates the measured voltage. The compensation of the leads is preserved until the instrument is switched off.

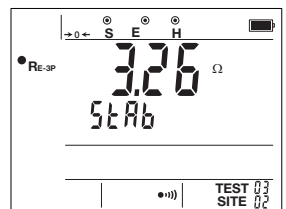
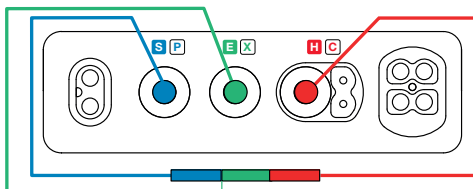

- Choose the value of limit voltage  $U_L$ : 25 or 50 V. Refer to § 3.5.2.
- Plant the H and S rods in line with the earth electrode. The distance between the S rod and the earth electrode must be approximately 62% of the distance between the H rod and the earth electrode.
- In order to avoid electromagnetic interference, we recommend laying out the full length of the cables, placing them as far apart as possible, and not making loops.

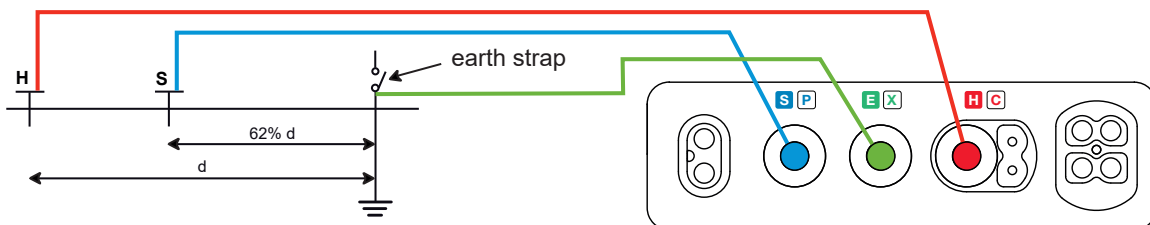

- Connect the cables to the H and S terminals. Power down the installation and disconnect the earth strap. Then connect the E terminal to the earth electrode to be checked.

- Press the **TEST** button to start the measurement.  
The instrument first displays - - - for several seconds.

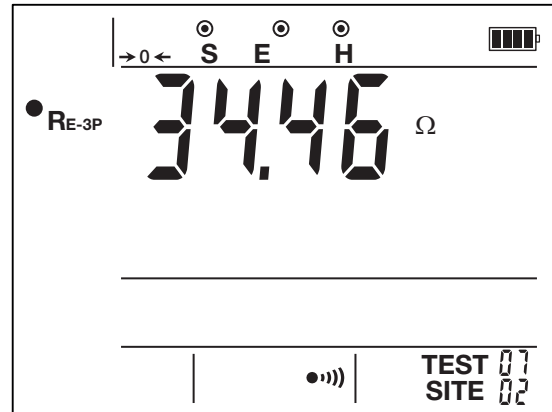

Do not forget to reconnect the earth strap at the end of the measurement before powering the installation back up.

### 3.4.4. VALIDATION OF THE MEASUREMENT

To validate your measurement, move the S rod towards the H rod by 10% of  $d$  and make another measurement. Then move the S rod, again by 10% of  $d$ , but towards the earth electrode.

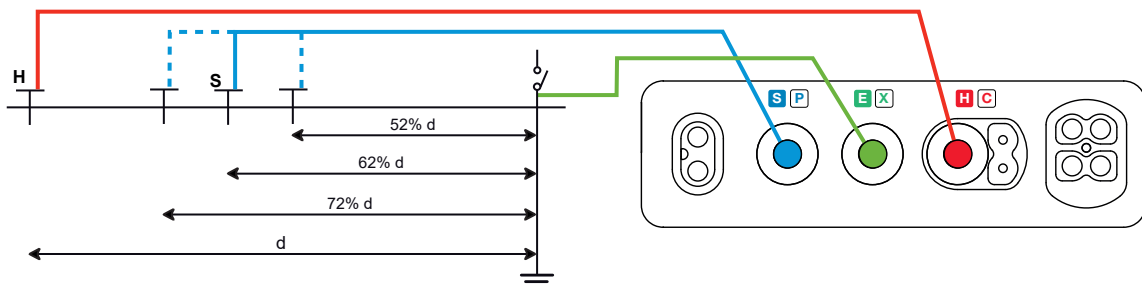

The 3 measurement results must be the same to within a few percent. If this is the case, the measurement is valid. If not, it is because the S rod is in the zone of influence of the earth electrode.

### 3.4.5. POSITIONING OF THE AUXILIARY RODS

To make sure that your earth measurements are not distorted by interference, we recommend repeating the measurement with the auxiliary rods placed at a different distance and in another direction (for example rotated 90° from the first alignment).

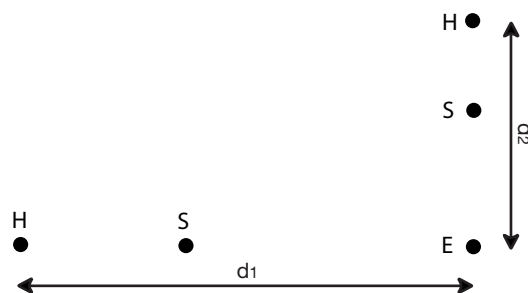

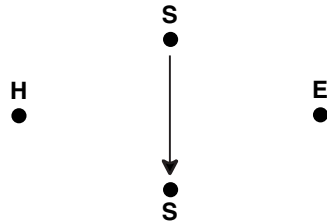

If you find the same values, your measurement is reliable. If the measured values are substantially different, it is probable that they were influenced by earth currents or a groundwater artery. It may be useful to drive the rods deeper.

If the in-line configuration is not possible, you can plant the rods in a triangle. To validate the measurement, move the S rod on either side of the line HE.



Avoid routing the connecting cables of the earth rods near or parallel to other cables (transmission or power supply), metal pipes, rails, or fences, this in order to avoid the risk of cross-talk with the measurement current.

#### 3.4.6. ERROR INDICATION

- If there is a spurious voltage on the terminals, having an amplitude between 7V and  $U_L$  (25 or 50V), the **NOISE** symbol is displayed and the **TEST** button cannot be pressed.
- If there is a spurious voltage on the terminals, having an amplitude greater than  $U_L$  (25 or 50V), it is hazardous; the  symbol is displayed and the **TEST** button cannot be pressed.
- If the resistance of the H rod exceeds 15 k $\Omega$ , the **RH !** symbol blinks.
- If a spurious voltage appears during the measurement, the **NOISE** symbol is displayed.
- If a hazardous spurious voltage appears during the measurement, the  symbol is displayed and the measurement is aborted.

To reduce the resistance of the rods H (or S), you can add one or more rods, two metres apart, in the H (S) branch of the circuit. You can also drive them deeper and pack the earth around them, or wet it with a little water.

### 3.5. LOOP OR LINE IMPEDANCE MEASUREMENT

In a TN or TT type installation, the loop impedance measurement is used to calculate the short-circuit current and to size the protections of the installation (fuses or RCDs), especially their breaking capacity.

In a TT type installation, the loop impedance measurement makes it easy to determine the earth resistance without planting any rods and without cutting off power to the installation. The result obtained,  $Z_{L-PE}$ , is the loop impedance of the installation between the L and PE conductors. It is barely greater than the earth resistance.

From this value and the conventional touch voltage limit ( $U_L$ ), it is then possible to choose the rated differential operating current of the RCD:  $I_{\Delta N} < U_L / Z_{L-PE}$ .

This measurement cannot be made in an IT type installation because of the high earthing impedance of the supply transformer, which may even be completely isolated from earth.

#### 3.5.1. DESCRIPTION OF THE MEASUREMENT PRINCIPLE

In no-trip mode, the instrument makes the measurement with a current of 12mA between the L and PE terminals. This low current avoids tripping an RCD having a nominal current greater than or equal to 30mA.

In trip mode, the instrument makes the measurement with a current of 300mA between the L and PE terminals. This current will trip an RCD having a nominal current is less than or equal to 300mA;

The instrument then calculates the short-circuit current  $I_k = U_{LPE} / Z_{L-PE}$ .

The value of  $I_k$  serves to check the proper sizing of the protections of the installation (fuses or RCDs).

#### 3.5.2. MAKING A NO-TRIP LOOP MEASUREMENT



Press the **LOOP** key to select the **• LOOP** function.



- Use the **▶** key to select the limit voltage  $U_L$ : 25 or 50V.
- Connect the measuring cable to the device, then to the socket outlet of the installation to be tested.



If possible, first disconnect all loads from the network on which you make the loop measurement.

The instrument checks first of all that the voltage between the **L** and **PE** terminals is correct in both amplitude and frequency.

If it is, the  $U_L$  symbol lights steadily. Otherwise, the symbol blinks and it is not possible to make a loop measurement. If  $U_{LPE} < 90$  V, the instrument displays  $U_{LPE}$  and  $U_{NPE in}$  alternation.

If there is a voltage on protection conductor PE, the instrument detects it and the  $\triangle PE$  indicator lights to warn the user. This does not prevent starting the measurement.

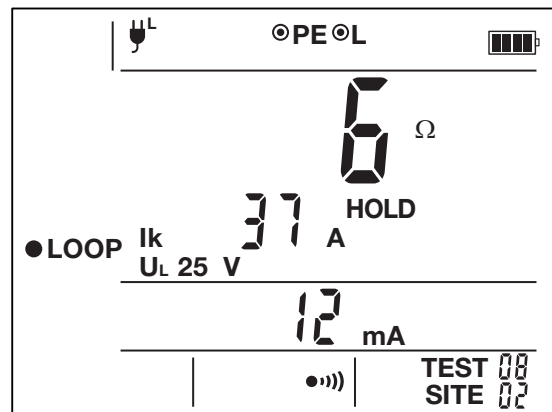
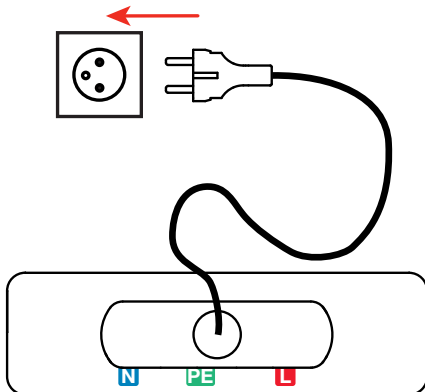

- The measurement starts automatically. The result is displayed: the loop impedance and the short-circuit current (Ik). Press the **TEST** key to return to voltage measurement.

### 3.5.3. MAKING A TRIP MODE LOOP MEASUREMENT



Press the LOOP key a second time to select the **• LOOP** function.

**LOOP**

- For better accuracy, compensate the leads. To do this, use separate leads. Connect them between the **L** and **PE** terminals, short-circuit them, and compensate the measurement leads by a sustained press on the **→ 0 ←** key, until the display unit indicates **StAb**. You can then release the key **→ 0 ←**. The compensation of the leads is kept until the instrument is switched off.

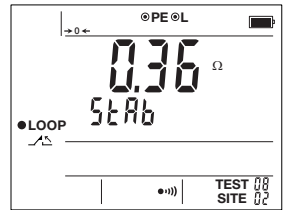
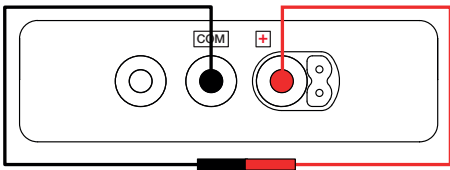

- Use the **▶** key to select the limit voltage  $U_L$ : 25 or 50V.
- Connect the leads to the installation to be tested.



If possible, first disconnect all loads from the network on which you make the loop measurement.

The instrument checks first of all that the voltage between the **L** and **PE** terminals is correct in both amplitude and frequency. If it is, the **L<sup>U</sup>** symbol lights steadily; otherwise, it blinks and it is impossible to make a loop measurement.

If there is a voltage on protection conductor PE, the instrument detects it and the **PE** indicator lights to warn the user. This does not prevent starting the measurement.

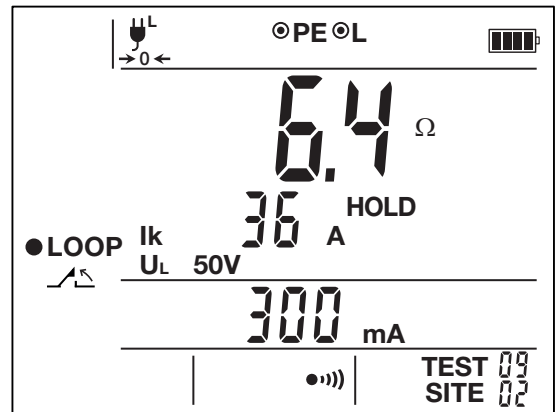
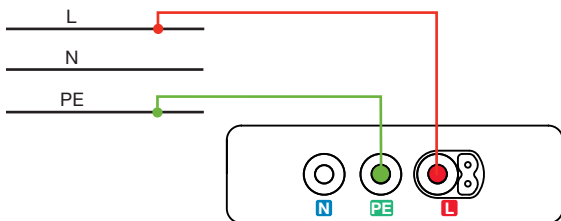

- Press the **TEST** key to start the measurement. The result is displayed: the loop impedance and the short-circuit current (Ik).
- Press the **TEST** key again to return to voltage measurement.

### 3.5.4. MAKING A LINE IMPEDANCE MEASUREMENT

The measurement of the loop impedance,  $Z_L$ , between L and N or between two phases, can be used to calculate the short-circuit current and size the protections of the installation (fuse or RCD).



**LOOP**

Press the **LOOP** key a third time. The function does not change (● **LOOP** ↗↘) but the names of the terminals change to **NL2** and **L1**.

- For better accuracy, compensate the leads. To do this, use separate leads. Connect them between the **L** and **PE** terminals, short-circuit them, and compensate the measurement leads by a sustained press on the **→ 0 ←** key, until the display unit indicates **StAb**. You can then release the key **→ 0 ←**. The compensation of the leads is kept until the instrument is switched off.

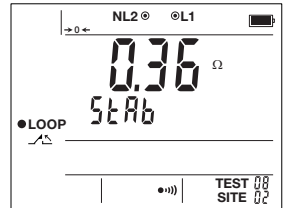
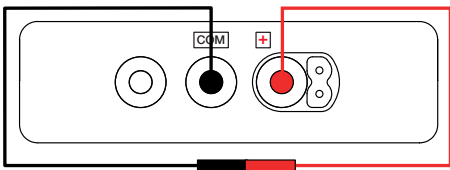

- Use the **▶** key to select the limit voltage  $U_L$ : 25 or 50V.
- Connect the leads to the installation to be tested.



If possible, first disconnect all loads from the network on which you make the measurement.

The instrument checks first of all that the voltage between the **L** and **PE** terminals is correct in both amplitude and frequency. If it is, the  $U^L$  symbol lights steadily; otherwise, it blinks and it is impossible to make measurement.

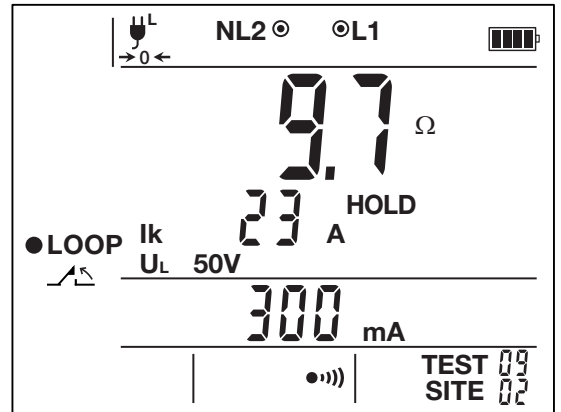
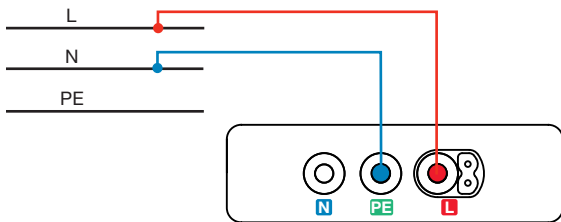

If there is a voltage on protection conductor PE, the instrument detects it and the  $\Delta PE$  indicator lights to warn the user. This does not prevent starting the measurement.



- Press the **TEST** key to start the measurement. The result is displayed: the loop impedance and the short-circuit current ( $I_k$ ).
- Press the **TEST** key again to return to voltage measurement.



### 3.5.5. ERROR INDICATION

- If the voltage measured between the **L** and **PE** terminals is not OK, in either amplitude or frequency, the  symbol blinks.
- If, during the measurement, the fault voltage,  $U_F$ , is greater than the limit voltage,  $U_L$ , the measurement is aborted and the  $U_F$  symbol blinks.
- If, during the measurement, the voltage between the **L** and **PE**,  $U_{LPE}$ , terminals is cut off, the measurement is aborted and the  symbol blinks.
- If, during the trip-mode measurement, the instrument overheats because of the high current, the  symbol blinks and you can no longer make a measurement until the instrument cools.

To exit from the error screens, press the **TEST** key.

### 3.6. TEST OF RESIDUAL CURRENT DEVICE

The instrument can be used to perform three types of test on type A and AC RCDs:

- a non-tripping test,
- a tripping test in pulse mode,
- a tripping test in ramp mode.

The non-tripping test serves to check that the RCD does not trip at a current of  $0,5 I_{\Delta N}$ . For this test to be valid, the leakage currents must be very small with respect to  $0,5 I_{\Delta N}$  and this requires that all loads downstream of the RCD being tested be disconnected.

The test in ramp mode serves to determine the exact value of the tripping current of the RCD.

The test in pulse mode serves to determine the tripping time of the RCD.

#### 3.6.1. DESCRIPTION OF THE MEASUREMENT PRINCIPLE

For each of the three types of test, the instrument starts by checking that voltage  $U_{LPE}$  is correct in both amplitude and frequency (C.A 6133 only).

The instrument then checks that the RCD can be tested without compromising the user's safety, in other words that the fault voltage,  $U_F$ , does not exceed  $U_L$  (25 or 50 V). The instrument accordingly makes a loop measurement with a low current (12mA). It then calculates  $U_F = Z_S \times I_{\Delta N}$  (or  $U_F = Z_S \times 5 I_{\Delta N}$ ). If the result is greater than  $U_L$ , the instrument so indicates, but does not prevent making the test.

- For the no-trip test, the instrument generates a current of  $0,5 I_{\Delta N}$  for 300 ms. Normally, the RCD must not trip.
- For the test in pulse mode, the instrument generates a current at the mains frequency having an amplitude of  $I_{\Delta N}$  or  $5 I_{\Delta N}$  between the L and PE terminals, for at most 300 or 40ms, depending on the value of the test current. And it measures the time the RCD takes to break the circuit. This time must be less than 300ms.
- For the test in ramp mode, the instrument generates a current of which the amplitude increases gradually, with 22 200ms plateaus, from  $0,3$  to  $1,06 I_{\Delta N}$  between the L and PE terminals. When the RCD breaks the circuit, the instrument displays the exact value of the tripping current.

During the measurement, the instrument checks that the test of the RCD does not compromise the user's safety, in other words that the fault voltage,  $U_F$ , does not exceed  $U_L$  (25 or 50 V). If it does, the instrument aborts the measurement.

#### 3.6.2. MAKING A NO-TRIP TEST



Press the **RCD** key to select the **• RCD** function.





- Press the ► key; the waveform blinks. You can change it using the ▲ key:  $\sim$  or  $\sphericalangle$ .
- Press the ► key again; the value of  $I_{\Delta N}$  blinks. You can change it using the ▲ key: 30mA, 100mA, 300mA, 500mA or 650mA.
- Press the ► key a third time; the value of limit voltage  $U_L$  blinks. You can change it using the ▲ key: 25 or 50V.
- A final press on the ► key terminates the configuration of the measurement.
- Connect the tripod cable to the instrument, then to an outlet that is part of the circuit protected by the RCD to be tested.

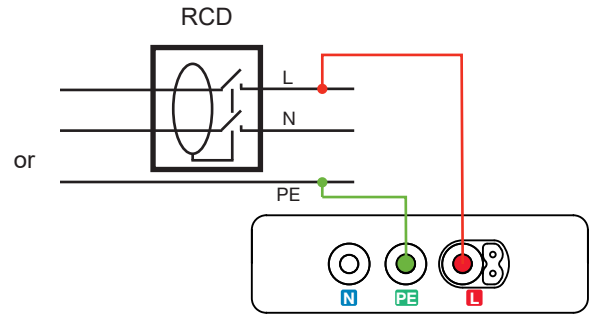
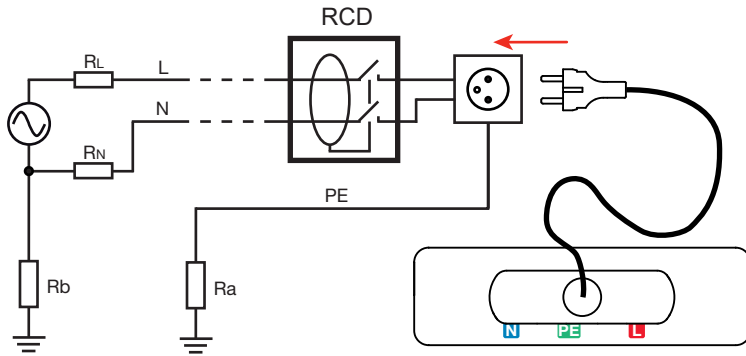

First, disconnect all loads from the network protected by the RCD to be tested.



The instrument first of all checks that the voltage between the L and PE terminals is correct. If it is, the  symbol lights steadily. If not, the symbol blinks and it is not possible to make a test. If  $U_{LPE} < 90\text{ V}$ , the instrument displays  $U_{LPE}$  and  $U_{NPEin}$  alternation.

If there is a voltage on protection conductor PE, the instrument detects it and the  indicator lights to warn the user. This does not prevent starting the measurement.

- Press the **TEST** button to start the measurement. The result is displayed: fault voltage UF. If the test result is OK, the  indicator lights.

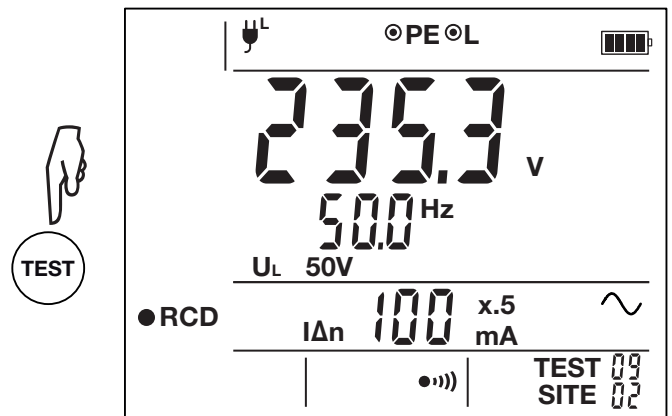
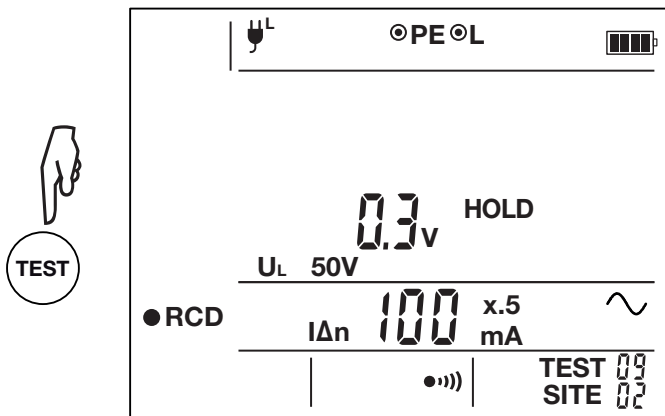





- Press the **TEST** key again to return to voltage measurement.

### 3.6.3. PERFORMING A TEST IN RAMP MODE





This test is done only on 30mA RCDs. Press the **RCD** key a second time to select the **RCD** function. The  symbol blinks to indicate the risk of tripping.

- Press the **▶** key; the type of RCD blinks. You can change it using the **▲** key: A or AC.
- Press the **▶** key a second time; the waveform blinks. You can change it using the **▲** key: , , , or .
- Press the **▶** key a third time; the value of limit voltage  $U_L$  blinks. You can change it using the **▲** key: 25 or 50 V.
- A final press on the **▶** key terminates the configuration of the measurement.
- Connect the tripod cable to the instrument, then to an outlet that is part of the circuit protected by the RCD to be tested.



If possible, first disconnect all loads from the network protected by the RCD to be tested.

The instrument first of all checks that the voltage between the **L** and **PE** terminals is correct. If it is, the  symbol lights steadily. If not, the symbol blinks and it is not possible to make a test.

If there is a voltage on protection conductor PE, the instrument detects it and the  **PE** indicator lights. This does not prevent starting the measurement.

- Press the **TEST** button to start the measurement. The result is displayed: the tripping current and the fault voltage  $U_F$ . If the test result is OK, the  indicator lights.

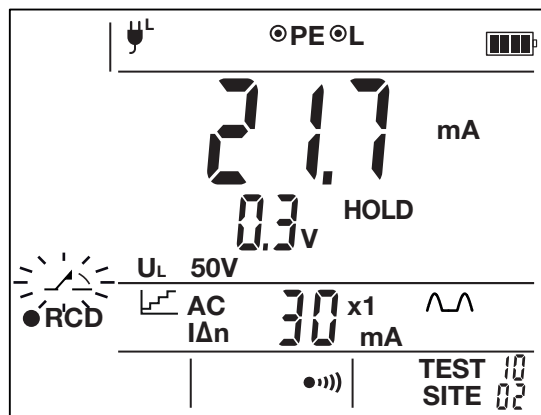









- Press the **TEST** key again to return to voltage measurement.

### 3.6.4. MAKING A TEST IN PULSE MODE



**RCD**

Press the **RCD** key a third time to select the  **RCD** function. The  symbol blinks to indicate the risk of tripping.

- Press the **▶** key; the type of RCD blinks. You can change it using the **▲** key: A or AC.
- Press the **▶** key a second time; the waveform blinks. You can change it using the **▲** key: , , , or . If the AC type is chosen, only the  and  waveforms will be available.
- Press the **▶** key a third time; the multiplier blinks. You can change it using the **▲** key: x1 or x5.
- Press the **▶** key a fourth time, the value of  $I_{\Delta N}$  blinks. You can change it using the **▲** key: 30 mA, 100 mA, 300 mA, 500 mA or 650 mA.
- Press the **▶** key a fifth time; the value of limit voltage  $U_L$  blinks. You can change it using the **▲** key: 25 or 50 V.
- A final press on the **▶** key terminates the configuration of the measurement.
- Connect the tripod cable to the instrument, then to an outlet that is part of the circuit protected by the RCD to be tested.



If possible, first disconnect all loads from the network protected by the RCD to be tested.

The instrument first of all checks that the voltage between the **L** and **PE** terminals is correct. If it is, the  symbol lights steadily. If not, the symbol blinks and it is not possible to make a test.





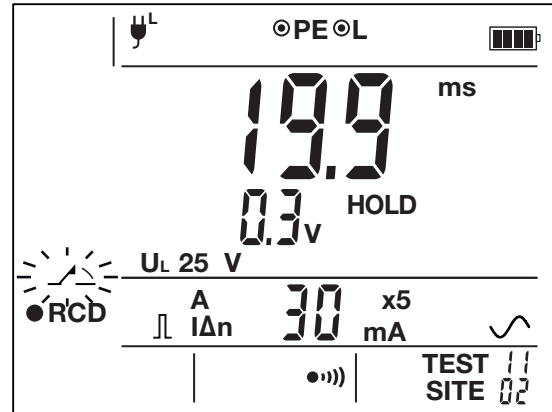

If there is a voltage on protection conductor PE, the instrument detects it and the  **PE** indicator lights to warn the user. This does not prevent starting the measurement.

- Press the **TEST** button to start the measurement. The result is displayed: the tripping time and the fault voltage  $U_F$ . If the test result is OK, the  indicator lights.



- Press the **TEST** key again to return to voltage measurement.

### 3.6.5. ERROR INDICATION

- If the voltage measured between the **L** and **PE** terminals is not OK, in either amplitude or frequency, the  symbol blinks.
- If there is a voltage on protection conductor PE, the instrument detects it and the  PE indicator lights.
- If, during the test, the fault voltage,  $U_F$ , is greater than the limit voltage,  $U_L$ , the measurement is aborted and the  $U_F$  symbol blinks.
- If, during the test, the voltage between the **L** and **PE**,  $U_{LPE}$ , terminals is cut off, the measurement is aborted and the  symbol blinks.
- If the RCD trips in a no-trip test, the instrument indicates that there is a problem by lighting the  indicator. Check that the value of  $I_{\Delta N}$  is OK. Also check your connection.
- If, in ramp mode, the RCD does not trip, the instrument displays  $>30\text{mA}$ . The  indicator lights. Check that the RCD tested in fact has an  $I_{\Delta N}$  of  $30\text{mA}$ . Also check your connection.
- If, in pulse mode, the RCD does not trip, the instrument displays  $>300\text{ms}$  for a current of  $I_{\Delta N}$  or  $>40\text{ms}$  for a current of  $5 I_{\Delta N}$ . The  indicator lights. Check that the value of  $I_{\Delta N}$  is correct. Also check your connection.
- If, during the test, the instrument overheats because of the high current, the  symbol blinks and you can no longer test until the instrument cools.

To exit from the error screens, press the **TEST** key.

### 3.7. CURRENT MEASUREMENT

The C.A 6131 can make current measurements on the 0-2V sensor input. This requires the use of an external sensor (not provided).

The C.A 6133 can make current measurements using a specific ammeter clamp, the optional MN73A. The C.A 6133 and MN73A clamp together can measure very low currents, of the order of a few mA, such as fault currents or leakage currents, and high currents, of the order of a few hundreds of amperes.

#### 3.7.1. DESCRIPTION OF THE MEASUREMENT PRINCIPLE

The C.A 6131 measures the voltage on its sensor input and displays it. The user must then convert the voltage displayed into a current using the transformation ratio of the sensor.

The specific ammeter clamp associated with the C.A 6133 operates on the current transformer principle: the primary is constituted by the conductor in which the current is to be measured, while the secondary is constituted by the internal winding of the clamp. This winding is itself closed through a resistance having a very low value, located in the device. The voltage across the terminals of this resistance is measured by the device.

Two of the four points of connection of the clamp recognize the range of the clamp and the other two measure the current. Knowing the ratio of the clamp, the device displays a direct reading of the current.

#### 3.7.2. MAKING A MEASUREMENT WITH THE C.A 6131



Press the **AUX** key to select the **AUX** function.



Connect the leads between the **+** and **COM** terminals and the external sensor.

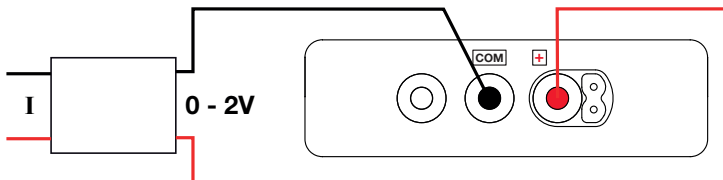

The measurement is displayed.

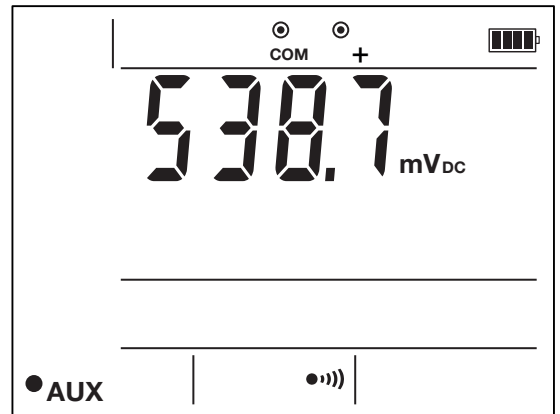

Then convert the voltage displayed into a current using the transformation ratio (TR) of the sensor:

$$I = V * (RT \text{ in } A/V) \quad \text{or} \quad I = \frac{V}{RT \text{ in } V/A}$$

#### 3.7.3. ERROR INDICATION

If the measurement is outside the measurement range, the instrument so indicates it.

### 3.7.4. MAKING A MEASUREMENT WITH THE C.A 6133



V / I

Press the **V** key to select the **• V** function.  
Connect the MN73A clamp to the current input. The instrument recognizes it and switches to current measurement **• I** and the  symbol is displayed.

Squeeze the trigger to open the clamp and place it on the conductor to be measured. Release the trigger. Depending on the value measured, choose the 2 or 200A range.

The measurement is displayed.

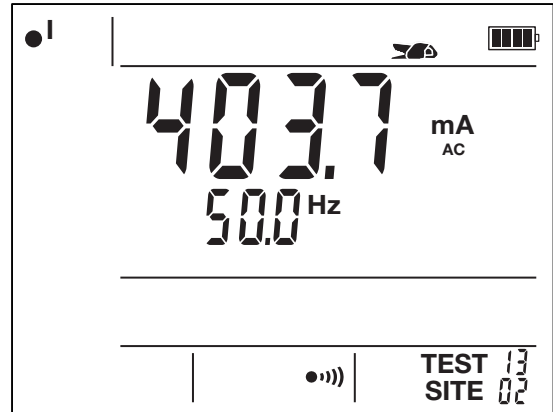
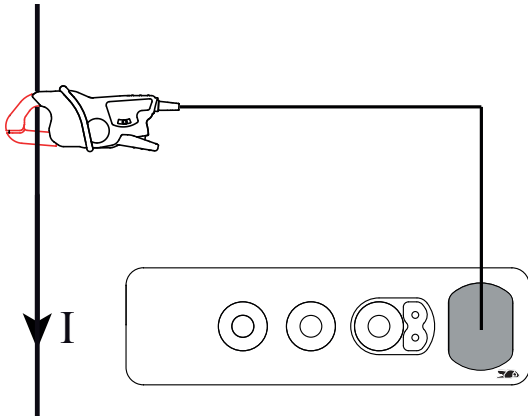

This current measurement can be made only in AC.

### 3.7.5. ERROR INDICATION

If the measured value is outside the measurement range, in either current or frequency, the instrument so indicates.

### 3.8. DIRECTION OF PHASE ROTATION

This measurement is made on a three-phase network. It is used to check the phase order of the network.

#### 3.8.1. DESCRIPTION OF THE MEASUREMENT PRINCIPLE

The device checks that the three signals are at the same frequency, then compares the phases to determine their order (direct or reverse direction).

#### 3.8.2. MAKING A MEASUREMENT



Press the **V** key to select the  $\bullet U_{123}$  function.



Connect the 3 leads to the 3 phases in the correct order.

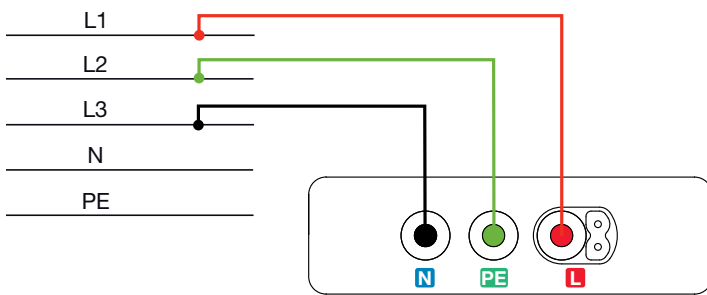

The phase-to-phase voltages are displayed, the values  $U_{12}$ ,  $U_{23}$  and  $U_{32}$  in cyclic succession, along with the direction of phase rotation,  $\overset{L1}{\curvearrowright} \overset{L3}{L3\_L2}$  or  $\overset{L1}{\curvearrowleft} \overset{L3}{L1\_L2}$ .

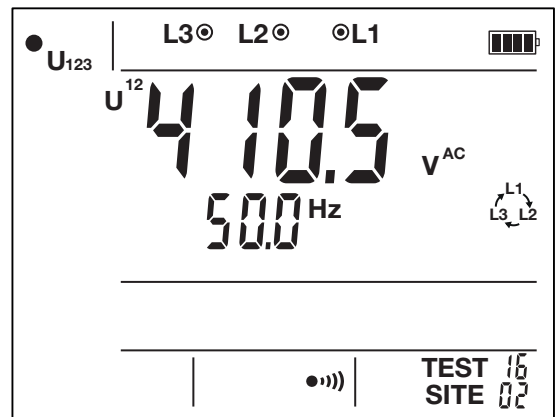

$\overset{L1}{\curvearrowright} \overset{L3}{L3\_L2}$  corresponds to a direct phase order.  
 $\overset{L1}{\curvearrowleft} \overset{L3}{L1\_L2}$  corresponds to a reverse phase order.

#### 3.8.3. ERROR INDICATION

The instrument indicates whether:











- the measured value is outside of the measurement range, in either voltage or frequency,
- the amplitude unbalance is >20%, by the blinking of  $\overset{LU}{\curvearrowright}$ ,  $\overset{L1}{\curvearrowright} \overset{L3}{L3\_L2}$ , and  $\overset{L3}{\curvearrowright} \overset{L1}{L1\_L2}$ .
- the phase difference between the voltages is incorrect ( $\pm 120^\circ \pm 30^\circ$ ).

Any connection error (for example the neutral in the place of a phase) is indicated by the blinking of the  $\overset{LU}{\curvearrowright}$  symbol.



### 3.9. AUTO RCD FUNCTION (C.A 6133)

The **AUTO RCD** function allows a rapid test of the RCDs of an installation using an automatic sequence, with the instrument connected to a single outlet. When this function is started, 6 or 8 tests are performed in succession:

- 2 RCD tests in no-trip mode:  and .
- 4 RCD tests in pulse mode: , ,  and .
- 2 RCD tests in ramp mode if the RCD is 30mA:  and  or  and .

For these tests, it is the last pulse mode configuration that will be used.

The user must reset the device after each tripping.

#### 3.9.1. MAKING A MEASUREMENT



Press the **AUTO** key to select the **• AUTO RCD** function.



Connect the instrument as described in §3.6. The parameters that will be used are recalled on the display unit. Press the **TEST** button to start the automatic test of the RCD.

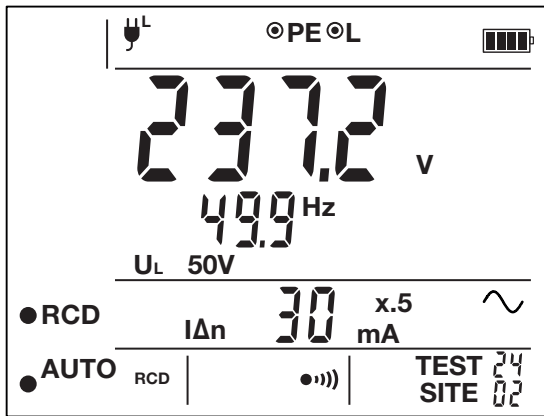

If one of the test results is not good, the instrument so indicates by lighting the **✘** indicator and breaks off the series. At the end of the series of tests, the instrument displays End and the **☑** indicator is lit. The **▶** key is used to display each result.

The **TEST** button is pressed to return to the starting screen.

#### 3.9.2. ERROR INDICATION

Refer to the RCD test error indications in §3.6.5.

### 3.10. AUTO LOOP RCD MΩ FUNCTION (C.A 6133)

The **AUTO LOOP RCD MΩ** function is used for a rapid test of the installation using an automatic sequence, with the instrument connected to a single outlet. Three tests are started in succession:

- A no-trip loop measurement,
- A no-trip RCD test,
- An RCD test in pulse or ramp mode,
- An insulation measurement.

Each test is performed with the last configurations defined for each function. If the last selection of the RCD test was no-trip, the test performed will be in pulse mode.

#### 3.10.1. MAKING A MEASUREMENT



Press the **AUTO** key a second time to select the **• AUTO LOOP RCD MΩ** function.



Connect the instrument to the outlet to be tested. The parameters that will be used are recalled on the display unit. If you want to change them, return to the LOOP, RCD, or MΩ functions. Press the **TEST** button to start the sequence of tests.

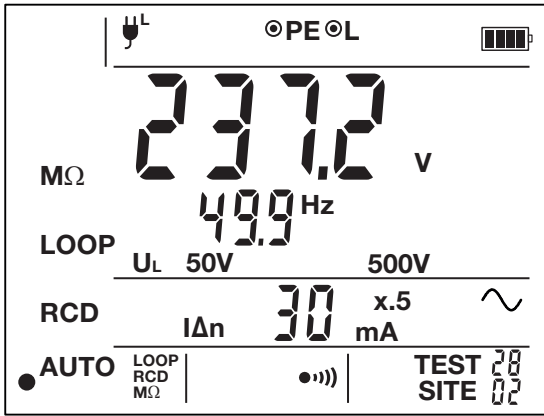

If one of the test results is not good, the instrument so indicates by lighting the **✗** indicator and breaks off the series. At the end of the series of tests, the instrument displays End and the **☑** indicator is lit. The **▶** key is used to display each result.

The **TEST** button is pressed to return to the starting screen.

#### 3.10.2. ERROR INDICATION

Refer to the error indications of the loop measurement in §3.5.5, of the RCD test in §3.6.5, and of the insulation measurement in §3.3.4.

## 4. MEMORY FUNCTION (C.A 6133)

### 4.1. ORGANIZATION OF THE MEMORY

The memory is organized in sites, 30 at most, each of which can contain up to 99 tests.

### 4.2. STORING MEASUREMENTS



At the end of each measurement, you can record it by pressing the **MEM** key.

**MEM**

Each press on **MEM** records the measurement screen. And the test number is incremented.

If the measurement includes several screens, like the automatic test sequences that contain up to 8 of them, the test number is incremented accordingly.

You can also record error screens.

When you record a measurement, you can choose whether to put it into the same site, with the next test number, or into a new site. To do this, long-press the **MEM** key, select the site using the **▲** key, and long-press the **MEM** key again.

### 4.3. READING THE MEASUREMENTS



To read recorded measurements, press the **MR** key.

**MR**

The **MR** symbol is displayed, along with the last measurement recorded.

The **TEST** symbol blinks. You can use the **▲** key to modify the test number and the corresponding measurement will be displayed.

Pressing the **▶** key causes the **SITE** symbol to blink. You can change the site number using the **▲** key.

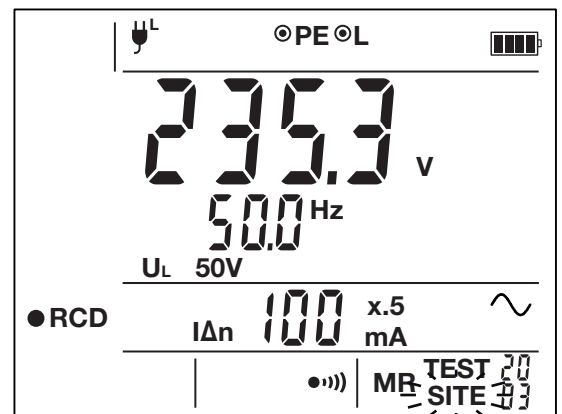
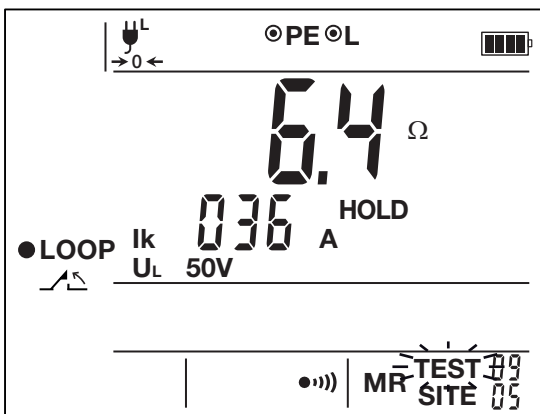

The instrument will then display the last test of the site selected.

A long press on the **▲** key is used for rapid scrolling.

To exit from memory read, press any function key.

## 4.4. ERASING MEASUREMENTS



To erase the recorded measurements, long-press the **MR** key.



The instrument then displays **clr?** to request confirmation of the erasure.

To abort the erasure, press any key.

To erase all recorded measurements, effect a second long press on the **MR** key.

When the memory has been erased, the instrument returns to measurement mode. The next record will be placed in test 01 of site 01.

## 5. BLUETOOTH LINK (C.A 6133)

---

The C.A 6133 has a Bluetooth communication module.



To activate the Bluetooth on the C.A 6133, long-press the  key.

The  symbol is displayed and the instrument attempts to connect to a device having a Bluetooth 2.0 link. There is no pairing code.

Install the IT-Report for Android application on your tablet or smartphone. It is used to communicate with the instrument.

You can then:

- know the state of the instrument,
- read the data recorded in the instrument in order to prepare a report.

# 6. TECHNICAL CHARACTERISTICS

## 6.1. GENERAL REFERENCE CONDITIONS

Quantity of influence	Reference values
Temperature	23 ± 2 °C
Relative humidity	45 to 55%RH
Supply voltage	C.A 6131: 8 ± 0.2 V C.A 6133: 6 ± 0.2 V
Frequency	45 to 65 Hz
Electric field	< 0.1V/m
Magnetic field	< 40A/m

The **intrinsic uncertainty** is the error defined under the reference conditions.

The **operating uncertainty** includes the intrinsic uncertainty plus the effects of variation of the quantities of influence (supply voltage, temperature, interference, etc.) as defined in standard IEC 61557.

The uncertainties are expressed in % of the reading (R) and in number of display points (pt):  
± (a% R + b pt)



The C.A 6133 is not designed to make measurements when the charger is connected.

## 6.2. ELECTRICAL CHARACTERISTICS

### 6.2.1. VOLTAGE MEASUREMENTS

**Particular reference conditions:**

- Peak factor =  $\sqrt{2}$  = 1.414 in AC (sinusoidal signal)
- AC component <0.1% in DC measurement
- DC component <0.1% in AC measurement

**Voltage measurements (voltage, phase order, insulation, loop measurement, and RCD test)**

Measurement range	2.0 - 550.0 Vac	± (0.0 - 800.0 Vdc)
Resolution	0.1 V	0.1 V
Intrinsic uncertainty	± (1% R + 2 pt)	± (1% R + 2 pt)
Input impedance	600 kΩ between terminals L and PE 600 kΩ between terminals N and PE	

**Hazardous voltage detection**

Detection range: 25 to 60V - 1000V

When the voltage exceeds the threshold (between 25 and 60V), the  PE indicator lights.

**Sensor function (C.A 6131)**Measurement input limited to  $\pm 2.2 V_{peak}$ 

Maximum acceptable permanent voltage: 1250VRMS

	AC + DC		DC	
Measurement range	2.0 - 999.9mV	1.000 - 1.200V	$\pm (0.0 - 999.9mV)$	$\pm (1.000 - 2.000V)$
Resolution	0.1mV	1mV	0.1mV	1mV
Intrinsic uncertainty	$\pm (1\% R + 2 \text{ pt})$	$\pm (1\% R + 2 \text{ pt})$	$\pm (1\% R + 2 \text{ pt})$	$\pm (1\% R + 2 \text{ pt})$
Input impedance	10 M $\Omega$		10 M $\Omega$	

**6.2.2. FREQUENCY MEASUREMENTS (C.A 6133)****Particular reference conditions:**

Voltage: within the measurement range.

Current: within the measurement range.

Measurement range	30.0 - 999.9Hz
Resolution	0.1Hz
Intrinsic uncertainty	$\pm (0.1\% R + 1 \text{ pt})$

If the frequency is  $<30\text{Hz}$  or if the signal is  $<2\text{V}$ , the instrument displays - - - -.

The frequency used for the calculations is 50 or 60Hz, depending on the network detected.

**6.2.3. CONTINUITY MEASUREMENTS****Particular reference conditions:**Resistance of the leads:  $\leq 0,1\Omega$  (compensated).

External voltage on the terminals: zero.

Inductance in series with the resistance:  $\leq 1 \text{ nH}$ .The compensation of the leads is effective up to 5 $\Omega$ .The response time for threshold detection  $<250\text{ms}$ .

Measurement range	0.00 – 9.99 $\Omega$
Resolution	0.01 $\Omega$
Measurement current	$\geq 200\text{mA}$
Intrinsic uncertainty	$\pm (2\% R + 2 \text{ pt})$
No-load voltage	$7\text{V} \leq U_v < 8\text{V}$

**6.2.4. RESISTANCE MEASUREMENTS****Particular reference conditions:**

External voltage on the terminals: zero.

Inductance in series with the resistance:  $\leq 1 \text{ nH}$ .

Measurement range	1 – 9,999 $\Omega$	10.00 – 99.,99k $\Omega$
Resolution	1 $\Omega$	10 $\Omega$
Intrinsic uncertainty	$\pm (1\% R + 5 \text{ pt})$	$\pm (1\% R + 5 \text{ pt})$
No-load voltage	4.5V	

**6.2.5. INSULATION RESISTANCE MEASUREMENTS**

**Particular reference conditions:**

- Capacitance in parallel: < 1 nF.
- Maximum acceptable external AC voltage during the measurement: zero.

**DC voltage measurements**

Measurement range	$\pm (0.0 - 999.9V)$	$\pm (1000 - 1200V)$
Resolution	0.1V	1V
Intrinsic uncertainty	$\pm (1\% R + 2 \text{ pt})$	$\pm (1\% R + 2 \text{ pt})$
Input impedance	10M $\Omega$	

**Insulation resistance**

Measurement range	0.00 - 99.99 M $\Omega$		100.0 - 999.9 M $\Omega$
Measurement range at 250 V	0.01 - 1.99 M $\Omega$	2.00 - 99.99 M $\Omega$	100.0 - 999.9 M $\Omega$
Measurement range at 500 V	0.01 - 0.99 M $\Omega$	1.00 - 99.99 M $\Omega$	100.0 - 999.9 M $\Omega$
Measurement range at 1000 V	0.01 - 0.49 M $\Omega$	0.50 - 99.99 M $\Omega$	100.0 - 999.9 M $\Omega$
Resolution	10 k $\Omega$	10 k $\Omega$	100 k $\Omega$
Intrinsic uncertainty	$\pm (5\% R + 3 \text{ pt})$	$\pm (3\% R + 3 \text{ pt})$	$\pm (3\% R + 3 \text{ pt})$
No-load voltage	$\leq 1.25 \times U_N$		
Nominal current	$\geq 1 \text{ mA}$		
Short-circuit current	$\leq 3 \text{ mA}$		

**Typical test voltage vs load curve**

The voltage developed as a function of the resistance measured has the following form:

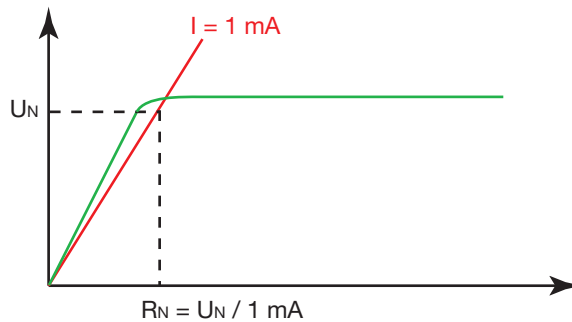

**Typical measurement settling time as a function of the elements tested**

Test voltage	Load	Non-capacitive	With 100 nF	With 1 $\mu$ F
250V - 500V - 1000V	10M $\Omega$	1s	2s	12s
	100M $\Omega$	1s	4s	30s

**Typical discharge time of a capacitive element to reach 25 Vdc**

Test voltage	250V	500V	1000V
Discharge time (C in $\mu$ F)	1s x C	2s x C	4s x C



**6.2.6. 3P EARTH RESISTANCE MEASUREMENTS (C.A 6133)**

**Particular reference conditions:**

- Resistance of the E lead:  $\leq 0.1\Omega$  (compensated).
- Interference voltages: zero.
- $R_H$  and  $R_S \leq 15\text{ k}\Omega$ .
- $(R_H + R_S) / R_E < 300$ .
- $R_E < 100 \times R_H$ .

The compensation of the leads is effective up to  $5\Omega$ .

**3P earth resistance**

Measurement range	0.50 - 99.99 $\Omega$	100.0 - 999.9 $\Omega$	1 000 - 2 000 $\Omega$
Resolution	0.01 $\Omega$	0.1 $\Omega$	1 $\Omega$
Typical peak-to-peak measurement current <sup>1</sup>	4.3mA	4.2mA	3.5mA
Intrinsic uncertainty	$\pm (2\% R + 10\text{ pt})$	$\pm (2\% R + 5\text{ pt})$	$\pm (2\% R + 5\text{ pt})$
Measurement frequency	128 Hz		
No-load voltage	25 V peak-to-peak		

1: current at mid-range with  $R_H = 1000\Omega$ .

**6.2.7. LOOP OR LINE IMPEDANCE MEASUREMENTS**

**Particular reference conditions:**

- Voltage of the installation: 90 to 550 V.
- Stability of the voltage source:  $< 0.05\%$ .
- Frequency of the installation: 45 to 65 Hz.
- Resistance of the leads:  $\leq 0,1\Omega$  (compensated).
- Contact voltage (potential of the protective conductor with respect to the local earth):  $< 5V$ .

The compensation of the leads is effective up to  $5\Omega$ .

**Characteristics of loop measurements in no-trip mode**

Measurement range	1 - 2 000 $\Omega$
Measurement range IEC 61557-3	10 - 2 000 $\Omega$
Resolution	1 $\Omega$
Measurement current I <sub>T</sub>	12 mA
Intrinsic uncertainty	$\pm (5\% R + 2\text{ pt})$

**Characteristics of loop and line measurements in trip mode**

Measurement range	0.1 - 399.9 $\Omega$
Measurement range IEC 61557-3	1.0 - 399.9 $\Omega$
Resolution	0,1 $\Omega$
Measurement current I <sub>T</sub>	300 mA
Intrinsic uncertainty	$\pm (5\% R + 2\text{ pt})$

**Characteristics of the short-circuit current calculation**

Calculation formula:  $I_k = U_{LPE} / Z_{LOOP}$

Calculation range	Trip mode 1 – 9.999A	No-trip mode 1 - 999A
Resolution	1A	1A
Intrinsic uncertainty for $U_{LPE} = 230V$	$\sqrt{(\text{intrinsic uncertainty on the voltage measurement})^2 + (\text{intrinsic uncertainty on the loop measurement})^2}$	

### 6.2.8. TEST OF RESIDUAL CURRENT DEVICE

**Particular reference conditions:**

- Voltage of the installation: 90 at 450V.
- Frequency of the installation: 45 to 65Hz.
- Contact voltage (potential of the protective conductor with respect to the local earth): < 5V.

**Limitation of the ranges accessible as a function of the voltage**

Wave  or 

I	30 mA	100 mA	300 mA	500 mA	650 mA
Ramp	✓	✗	✗	✗	✗
$I_{\Delta N}$ pulse	✓	✓	✓	✓	✓
5 x $I_{\Delta N}$ pulse	✓	✓ (V ≤ 280 V)	✗	✗	✗

Wave  or 

I	30 mA	100 mA	300 mA	500 mA	650 mA
Ramp	✓	✗	✗	✗	✗
$I_{\Delta N}$ pulse	✓	✓	✓	✓	✓
5 x $I_{\Delta N}$ pulse	✓	✓	✗	✗	✗

**Pulse mode and no-trip mode**

Range $I_{\Delta N}$	30mA - 100mA - 300mA - 500mA - 650mA		
Nature of the test	Non-tripping test	Tripping test	Tripping test
Test current	0.5 x $I_{\Delta N}$	$I_{\Delta N}$	5 x $I_{\Delta N}$
Intrinsic uncertainty on the test current	+0 ... -(7% + 2 mA)	0 ... +(7% + 2 mA)	0 ... +(7% + 2 mA)
Maximum duration of application of the test current	300 ms	300 ms	40 ms

**Trip time**

Measurement range	5.0 - 300.0 ms
Resolution	0.1 ms
Intrinsic uncertainty	± 2 ms

**Ramp mode**

Range $I_{\Delta N}$	30mA
Courant de test $I_T$	0.9573 x $I_{\Delta N}$ x k / 28
Intrinsic uncertainty on the test current	0 ... +(7% + 2mA)
Maximum duration of application of the test current	4600ms
Intrinsic uncertainty on the tripping current	-0 ... +(7% R + 3.3% $I_{\Delta N}$ + 2mA)
Resolution on the tripping current	0.1mA

k is between 9 and 31.

**Fault voltage ( $U_F$ )**

Measurement range	1.0 - 25.0 V	25.0 - 70.0 V
Resolution	0.1 V	0.1 V
Intrinsic uncertainty	± (15% R + 3 pt)	± (5% R + 2 pt)

### 6.2.9. CURRENT MEASUREMENT (C.A 6133)

#### Particular reference conditions:

Peak factor = 1,414  
DC component < 0,1%

The measurement input is protected up to 50 V, even in the case of connection of another clamp that has a compatible connector but is not designed to operate with the C.A 6133.

#### Characteristics with the MN73A clamp in 2A range

Measurement range	10.0 - 99.9mA	100.0 - 999.9mA	1.000 - 2.400A
Resolution	0.1mA	0.1mA	1mA
Intrinsic uncertainty	± (5% R + 20 pt)	± (3% R + 10 pt)	± (1% R + 2 pt)

No frequency measurement below 10.0mA.

#### Characteristics with the MN73A clamp in 200A range

Measurement range	1.00 - 19.99A	20.00 - 99.99A	100.0 - 149.9A	150.0 - 200.0A
Resolution	0.01A	0.01A	0.1A	0.1A
Intrinsic uncertainty	± (2% R + 4 pt)	± (1.5% R + 1 pt)	± (3% R + 1 pt)	± (7% R + 1 pt)

No frequency measurement below 0.5A.

### 6.2.10. MEASUREMENT ON THE VOLTAGE SENSOR (C.A 6131)

Measurement input limited to ± 2.2 V<sub>peak</sub>

	AC + DC		DC	
Measurement range	2.0 - 999.9mV	1.000 - 1.200V	± (0.0 - 999.9mV)	± (1.000 - 2.000V)
Resolution	0.1mV	1mV	0.1mV	1mV
Intrinsic uncertainty	± (1% R + 2 pt)	± (1% R + 2 pt)	± (1% R + 2 pt)	± (1% R + 2 pt)

### 6.2.11. DIRECTION OF PHASE ROTATION

#### Particular reference conditions:

Three-phase network.  
Voltage of the installation: 45 to 550 V.  
Frequency: 45 to 65 Hz.  
Acceptable level of amplitude unbalance: ≤ 20%.

#### Characteristics:

If  $\sin \varphi < -0.5$ , the direction of rotation is direct (anticlockwise).

If  $\sin \varphi > 0.5$ , the direction of rotation is reversed (clockwise).

If  $-0.5 < \sin \varphi < 0.5$  or if the acceptable amplitude unbalance >20%, the direction of phase rotation is not determined.

### 6.3. VARIATIONS IN THE RANGE OF USE

#### 6.3.1. VOLTAGE MEASUREMENT

Quantities of influence	Limits of the range of use	Variation of the measurement	
		Typical	Maximum
Temperature	-0 to + 40 °C	± (1%L/10°C + 2 pt)	± (2%L/10°C + 2 pt)
Relative humidity	40 to 95%RH	± (1.5%L + 2 pt)	± (3%L + 2 pt)
Supply voltage	C.A 6131: 6.0 to 9.6V C.A 6133: 6.0 to 7.2V	± (0.3%L + 2 pt)	± (0.5%L + 2 pt)
Frequency	30 to 1000 Hz	± (1%L + 1 pt)	± (2%L + 1 pt)
Series mode rejection in AC	0 to 1250Vdc	50dB	40dB
50/60Hz series mode rejection in DC	0 to 550Vac	50dB	40dB
Common mode rejection in 50/60Hz AC	0 to 550Vac	50dB	40dB

#### 6.3.2. INSULATION MEASUREMENT

Quantities of influence	Limits of the range of use	Variation of the measurement	
		Typical	Maximum
Temperature	-0 to + 40 °C	± (1%L/10°C + 2 pt)	± (2%L/10°C + 2 pt)
Relative humidity	40 to 95%RH	± (1.5%L + 2 pt)	± (3%L + 2 pt)
Supply voltage	C.A 6131: 6.0 to 9.6 V C.A 6133: 6.0 to 7.2 V	± (1%L + 2 pt)	± (2%L + 2 pt)
50/60Hz AC voltage superposed on the test voltage (U <sub>N</sub> )			
250 V / 500 V range	R ≤ 10 MΩ	0 to 20 V	± (2.5%L + 2 pt)
	R > 10 MΩ	0 to 0.3 V	± (2.5%L + 2 pt)
1000 V range	R ≤ 10 MΩ	0 to 20 V	± (2.5%L + 2 pt)
	R > 10 MΩ	0 to 0.3 V	± (2.5%L + 2 pt)
Capacitance in parallel on the resistance to be measured	0 to 5 μF @ 1 mA 0 to 2 μF @ 1000 MΩ	± (1.5%L + 2 pt)	± (3%L + 2 pt)

#### 6.3.3. RESISTANCE AND CONTINUITY MEASUREMENT

Quantities of influence	Limits of the range of use	Variation of the measurement	
		Typical	Maximum
Temperature	-0 to + 40 °C	± (1%L/10°C + 2 pt)	± (2%L/10°C + 2 pt)
Relative humidity	40 to 95%RH	± (2%L + 2 pt) in continuity ± (1.5%L + 2 pt) in resistance	± (4%L + 2 pt) in continuity ± (3%L + 2 pt) in resistance
Supply voltage	C.A 6131: 6.0 to 9.6 V C.A 6133: 6.0 to 7.2 V	± (0.2%L + 2 pt)	± (0.3%L + 2 pt)
50/60Hz AC voltage superposed on the test voltage	0.5 Vac	± (2.5%L + 2 pt)	± (5%L + 2 pt)

### 6.3.4. 3P EARTH MEASUREMENT (C.A 6133)

Quantities of influence	Limits of the range of use	Variation of the measurement	
		Typical	Maximum
Temperature	-0 to + 40 °C	± (1%L/10°C + 5 pt)	± (2%L/10°C + 5 pt)
Relative humidity	40 to 95%HR	± (1.5%L + 2 pt)	± (3%L + 2 pt)
Supply voltage	6.0 to 7.2V	± (1%L + 2 pt)	± (2%L + 2 pt)
Voltage in series in the voltage measurement loop (S-E) Fundamental= 16.6/50/60Hz + odd harmonics	15V ( $R_E \leq 40\Omega$ )	± (1%L + 50 pt)	± (2%L + 50 pt)
	25V ( $R_E > 40\Omega$ )	± (1%L + 2 pt)	± (2%L + 2 pt)
Voltage in series in the current injection loop (H-E) Fundamental= 16.6/50/60Hz + odd harmonics	15V ( $R_E \leq 40\Omega$ )	± (1%L + 50 pt)	± (2%L + 50 pt)
	25V ( $R_E > 40\Omega$ )	± (1%L + 2 pt)	± (2%L + 2 pt)
Current loop rod resistance ( $R_H$ )	0 to 15k $\Omega$	± (2%L + 5 pt)	± (4%L + 5 pt)
Voltage loop rod resistance ( $R_S$ )	0 to 15k $\Omega$	± (0.5%L + 5 pt)	± (1%L + 5 pt)

### 6.3.5. LOOP OR LINE MEASUREMENT

Quantities of influence	Limits of the range of use	Variation of the measurement	
		Typical	Maximum
Temperature	-0 to + 40 °C	± (1%L/10°C + 2 pt)	± (2%L/10°C + 2 pt)
Relative humidity	40 to 95%HR	± (1.5%L + 2 pt)	± (3%L + 2 pt)
Supply voltage	C.A 6131: 6.0 to 9.6 V C.A 6133: 6.0 to 7.2 V	± (0.2%L + 2 pt)	± (0.3%L + 2 pt)
Network frequency of the installation tested	99 to 101% of the nominal frequency	± (0.05%L + 1 pt)	± (0.1%L + 1 pt)
Network voltage of the installation tested	85 to 110% of the nominal voltage	± (0.05%L + 1 pt)	± (0.1%L + 1 pt)
Phase angle of the network	0 to 20°	± (0.5%L/10° + 2 pt)	± (1%L/10° + 2 pt)
Contact voltage ( $U_C$ )	0 to 50 V	Negligible (taken into account in the intrinsic uncertainty)	Negligible (taken into account in the intrinsic uncertainty)

### 6.3.6. CURRENT MEASUREMENT (C.A 6133)

Quantities of influence	Limits of the range of use	Variation of the measurement	
		Typical	Maximum
Temperature	-0 to + 40 °C	± (1%L/10°C + 2 pt)	± (2%L/10°C + 2 pt)
Relative humidity	40 to 95%RH	± (1.5%L + 2 pt)	± (3%L + 2 pt)
Supply voltage	6.0 to 7.2V	± (0.2%L + 2 pt)	± (0.3%L + 2 pt)
Frequency (MN73A clamp)	30 to 1 000Hz	± (1%L + 2 pt)	± (2%L + 2 pt)
50/60Hz series mode rejection in AC	0 to 550Vac	50dB	40dB

### 6.3.7. DIRECTION OF PHASE ROTATION

No quantity of influence

### 6.3.8. TEST OF RESIDUAL CURRENT DEVICE

Quantities of influence	Limits of the range of use	Variation of the measurement	
		Typical	Maximum
Temperature	-0 to + 40 °C	± (1%L/10°C + 2 pt)	± (2%L/10°C + 2 pt)
Relative humidity	40 to 95%HR	± (1.5%L + 2 pt)	± (3%L + 2 pt)
Supply voltage	C.A 6131: 6.0 to 9.6 V C.A 6133: 6.0 to 7.2 V	± (1.5%L + 2 pt)	± (3%L + 2 pt)
Network frequency of the installation tested	99 to 101% of the nominal frequency	± (0.05%L + 1 pt)	± (0.1%L + 1 pt)
Network voltage of the installation tested	90 to 110% of the nominal voltage	± (0.05%L + 1 pt)	± (0.1%L + 1 pt)

## 6.4. INTRINSIC UNCERTAINTY AND OPERATING UNCERTAINTY

The installation testers comply with standard IEC-61557, which requires that the operating uncertainty, called B, be less than 30%.

- In insulation,  $B = \pm ( |A| + 1,15 \sqrt{E_1^2 + E_2^2 + E_3^2} )$   
with A = Intrinsic uncertainty  
E<sub>1</sub> = influence of the reference position ± 90°.  
E<sub>2</sub> = influence of the supply voltage within the limits indicated by the manufacturer  
E<sub>3</sub> = influence of the temperature between 0 and 35°C.
- In continuity measurement,  $B = \pm ( |A| + 1,15 \sqrt{E_1^2 + E_2^2 + E_3^2} )$
- In loop measurement,  $B = \pm ( |A| + 1,15 \sqrt{E_1^2 + E_2^2 + E_3^2 + E_6^2 + E_7^2 + E_8^2} )$   
with E<sub>6</sub> = influence of the phase angle from 0 to 18°.  
E<sub>7</sub> = influence of the network frequency from 99 to 101% of the nominal frequency.  
E<sub>8</sub> = influence of the network voltage from 85 to 110% of the nominal voltage.
- In earth measurement,  $B = \pm ( |A| + 1,15 \sqrt{E_1^2 + E_2^2 + E_3^2 + E_4^2 + E_5^2 + E_7^2 + E_8^2} )$   
with E<sub>4</sub> = influence of the interference voltage in series mode (3 V at 16,6; 50; 60 and 400 Hz)  
E<sub>5</sub> = influence of the resistance of the rods from 0 to 100 x R<sub>A</sub> but ≤ 50 kΩ.

In RCD testing, the intrinsic uncertainty must be:

- from 0 to 10% for the test current generated,
- +/-10% for the measurement of the test current,
- +/-10% for the tripping time,
- 0 to 20% for the calculation of the fault voltage (U<sub>r</sub>).
- In test of residual current device,  $B = \pm ( |A| + 1,15 \sqrt{E_1^2 + E_2^2 + E_3^2 + E_5^2 + E_8^2} )$   
with E<sub>5</sub> = influence of the resistance of the probes within the limits indicated by the manufacturer.

## 6.5. POWER SUPPLY

The C.A 6131 is powered by 6 LR6 or AA primary batteries.

The C.A 6133 is powered by 6 Ni-MH rechargeable batteries.  
The charging time is less than 6 hours.



During charging, the instrument cannot make measurements. You can only read the data at memory.

Primary batteries or rechargeable batteries mass: about 6 x 26 g

### 6.5.1. LIFE BETWEEN CHARGES

The average battery life depends on the type of measurement. It is approximately 20 hours.

Typical life between charges of the device:

Function	C.A 6131 on primary batteries	C.A 6133 on rechargeable batteries
Voltage / Current	> 100 h	> 86 h
Phase order	> 100 h	> 86 h
Continuity at 200 mA	> 1,900 tests at 1Ω	> 1 700 tests à 1Ω
Insulation	> 2,000 tests at 1 MΩ for $U_N = 1000$ V	> 1 700 tests à 1 MΩ pour $U_N = 1000$ V
Earth, 3P		> 3,000 10-second measurements
Loop measurement	> 2 000 mesures	> 1 700 mesures
Differential test	> 3 000 tests	> 2 500 tests
Instrument off	> 1 year	> 1 year

## 6.6. ENVIRONMENTAL CONDITIONS

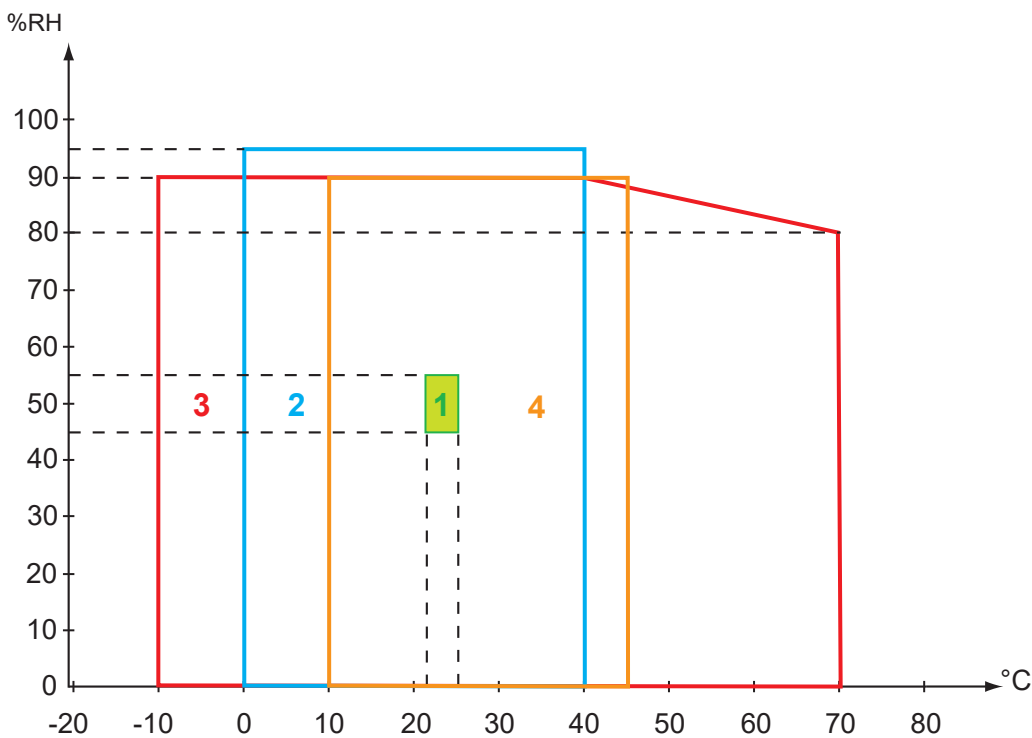

- 1 = Reference range, 21 to 25°C.
- 2 = Operating range, 0 to 40°C.
- 3 = Storage range (without batteries), -10 to +70°C.
- 4 = Range for recharging of the rechargeable batteries, 10 to 45°C.

Indoor and outdoor use.

Altitude < 2,000 m  
Pollution degree 2

The specified operating range corresponds to that of the operating uncertainty defined by the IEC 61557 standard. When the instrument is used outside of this range, 1.5 %/10°C must be added to the operating uncertainty, and 1.5% between 75 and 85% RH.

## 6.7. BLUETOOTH LINK (C.A 6133)

Bluetooth 2.1  
Class 1  
Band: 2 400 – 2 483.5 MHz  
Nominal output power: +12dBm

## 6.8. MECHANICAL CHARACTERISTICS

Dimensions (L x D x H) 223 x 126 x 70mm  
Weight approximately 1.1 kg

Protection class IP 54 per IEC 60529  
IK 04 per IEC 62262

Free fall test per IEC/EN 61010-2-030 or BS EN 61010-2-030

## 6.9. CONFORMITY TO INTERNATIONAL STANDARDS

The device is in conformity with IEC/EN 61010-2-030 or BS EN 61010-2-030 and IEC/EN 61010-2-034 or BS EN 61010-2-034, 600V CAT III.

Assigned characteristics: measurement category III, 600 V with respect to earth, 550 V in differential between the terminals, and 300V, CAT II on the charger input.

Instrument protected by reinforced insulation.

The C.A 6131 is compliant with IEC 61557 parts 1, 2, 3, 4, 6, 7, and 10.  
The C.A 6133 is compliant with IEC 61557 parts 1, 2, 3, 4, 5, 6, 7 and 10.

## 6.10. ELECTROMAGNETIC COMPATIBILITY (CEM)

The device is in conformity with standard IEC/EN 61326-1 or BS EN 61326-1.



# 7. MAINTENANCE



Except for the batteries, the instrument contains no parts that can be replaced by personnel who have not been specially trained and accredited. Any unauthorized repair or replacement of a part by an “equivalent” may gravely impair safety.

## 7.1. CLEANING

Disconnect everything connected to the instrument and switch it off.

Use a soft cloth, dampened with soapy water. Rinse with a damp cloth and dry rapidly with a dry cloth or forced air. Do not use alcohol, solvents, or hydrocarbons.

## 7.2. REPLACING THE BATTERIES

- Disconnect everything connected to the instrument and switch it off.
- Turn the instrument over and follow the instructions of §1.3.



Spent batteries must not be treated as ordinary household waste. Take them to the appropriate recycling collection point.

## 7.3. UPDATING OF THE INTERNAL SOFTWARE

With a view to providing, at all times, the best possible service in terms of performance and technical upgrades, Chauvin Arnoux invites you to update the embedded software of the device by downloading the new version, available free of charge on our web site.

See you on our site:

[www.chauvin-arnoux.com](http://www.chauvin-arnoux.com)

In **Support**, click on **Download our software** and enter the name of the instrument.

- Disconnect everything connected to the instrument and switch it off.
- Turn the instrument over and open the battery compartment cover as explained in §1.3.
- Connect the instrument to your PC using a micro USB to USB cable.

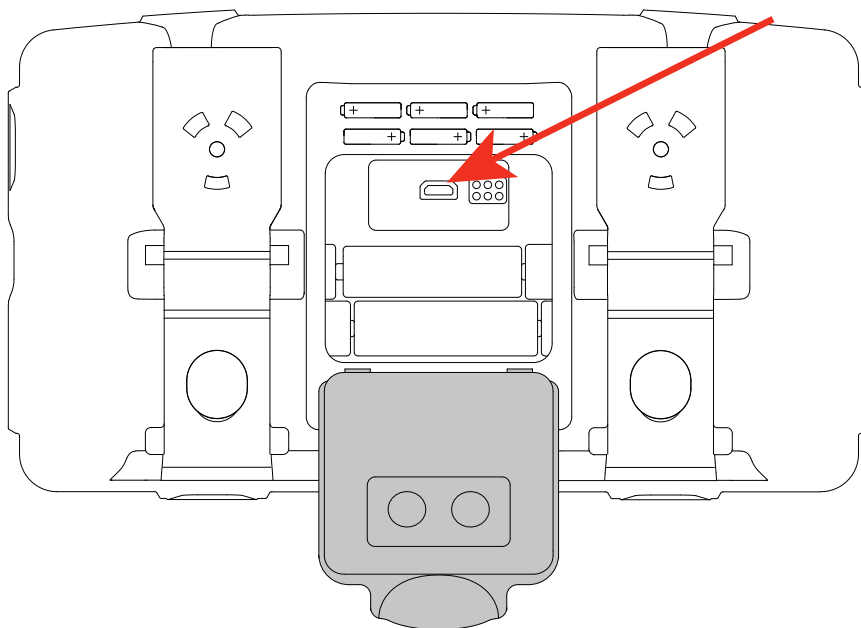

- Simultaneously press the  button and the **MEM** key (for the C.A 6133) or the **P** key (for the C.A 6131). The instrument displays **SOFT UPd**.

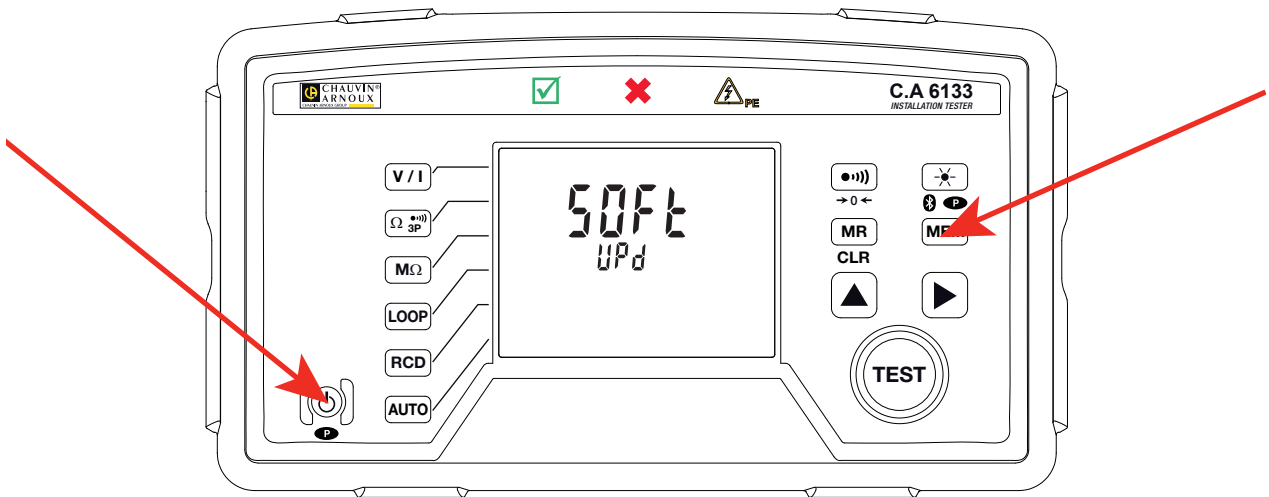

Updating the embedded software erases the recorded data and the configuration of the instrument. As a precaution save the data to a PC before updating the embedded software.

## 7.4. CALIBRATING THE INSTRUMENT

This must be done by qualified personnel. We recommend doing it once a year. This operation is not covered by the warranty.

### 7.4.1. EQUIPMENT NECESSARY

- A voltage and current calibrator. The CX1651 is recommended.
- A 50 Vdc power supply that can generate at least 300 mAdc
- 4 resistors, 50 kΩ, 200 kΩ, 10 MΩ, and 20 MΩ, 0.2%
- A Multi-Contact MLK1,5-BM/PLAST socket, used to make a cable to connect to a point on the specific outlets.

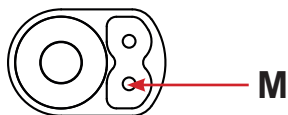

M = mass of the instrument

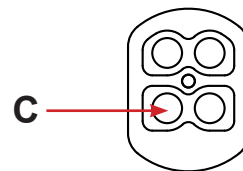

C = clamp input

7.4.2. CALIBRATION PROCEDURE



Press the  button to switch the instrument on.



Press the **MΩ** key to select the **• MΩ** function.

C.A 6131

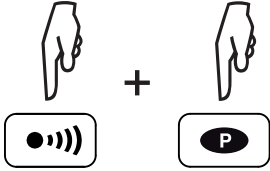

Simultaneously press the **•)))** and **P** keys (for the C.A 6131) or **•)))** and **MEM** keys (for the C.A 6133).

The instrument displays **AdJ** and the **✗** indicator lights.

C.A 6133

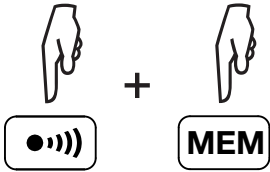

Press the **▶** key and hold it down until the  indicator lights.



Press the **TEST** key and hold it down until the  indicator goes off and the **P** symbol is displayed.

You can then start the first step of the adjustment (there are 26).

Set the desired value on the calibrator and connect it to the instrument as prompted. Validate by pressing the **TEST** key. The instrument displays **1** to indicate that it is performing the first step of the adjustment.

When it has finished, it displays **2**. Prepare the second step, then press the **TEST** key. Continue in this way up to the last step.

Some steps concern only the C.A 6133. If you adjust a C.A 6131, these steps will be omitted.

When the 25th step is validated, the 26th step consists in copying the coefficients to the memory of the instrument. If the adjustment process is interrupted before the end, no adjustment of the instrument will be modified.

If the instrument is unable to validate a step, it returns to it. In this case, check your connections and repeat the step.

To abort the adjustment process, press the  button to switch the instrument off.

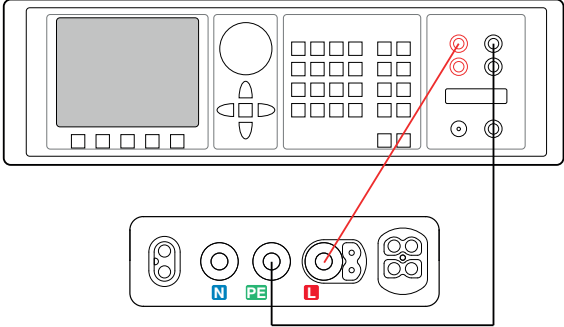
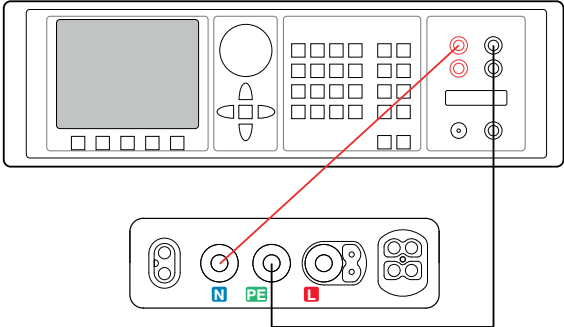
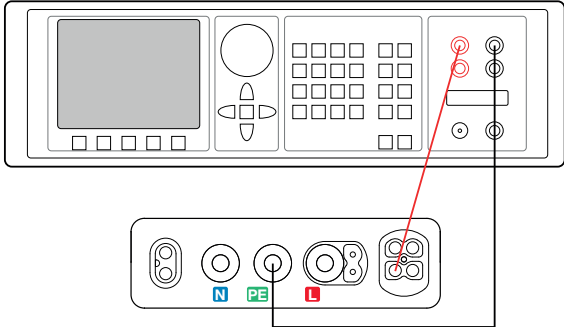
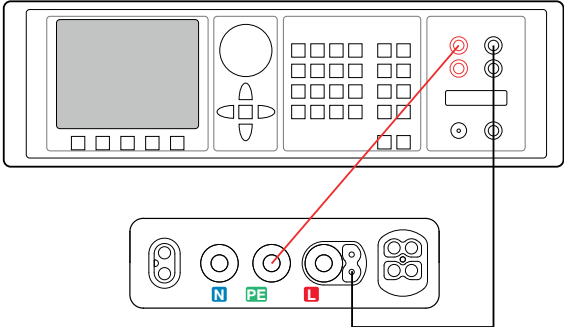
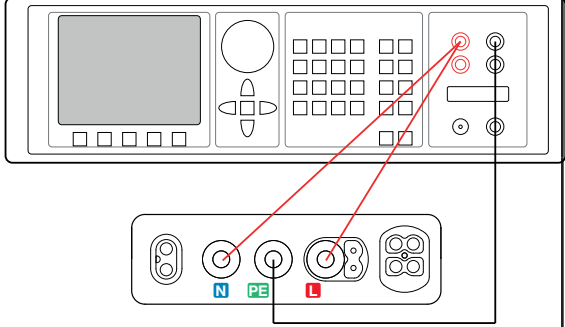
Step	Calibrator	Connection
1	0 Vdc	 <p>L: CX1651_Hi PE: CX1651_Lo</p>
2	500 Vdc	
3	10 Vdc	
4	2 Vdc	
5	0 Vdc	 <p>N: CX1651_Hi PE: CX1651_Lo</p>
6	500 Vdc	
7 C.A6133	0 Vdc	
8 C.A6133	10 Vdc	 <p>C: CX1651_Hi PE: CX1651_Lo</p>
9 C.A6133	0 Vdc	
10 C.A6133	2 Vdc	 <p>PE: CX1651_Hi M: CX1651_Lo</p>
11	1 Vdc	
12	2 Vdc	 <p>L and N: CX1651_Hi PE: CX1651_Lo</p>
13 C.A6133	1 Ω	
14 C.A6133	1900 Ω	

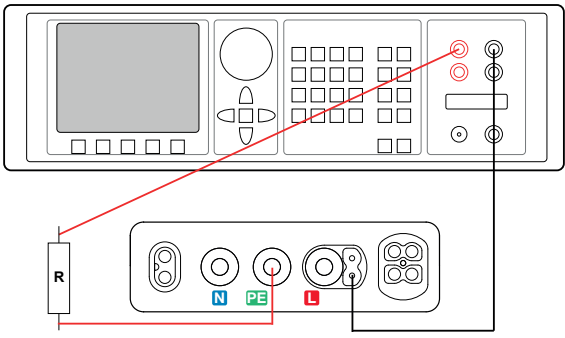
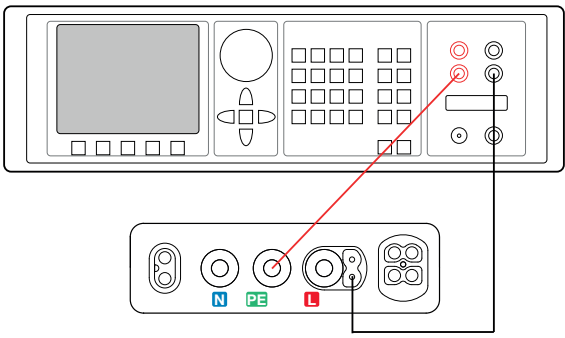
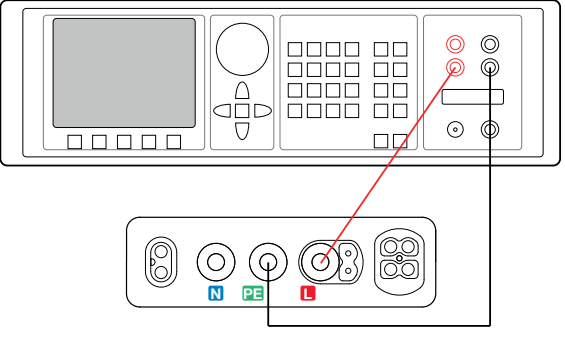
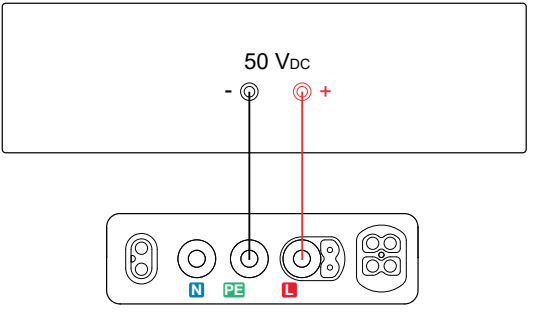
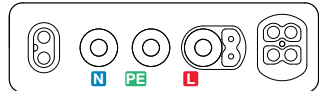
Step	Calibrator	Connection
15	100,26 Vdc R=20 MΩ	 <p>PE: CX1651_Hi R in serie on PE M: CX1651_Lo</p>
16	221,12 Vdc R=10 MΩ	
17	100,01 Vdc R=10 MΩ	
18	101 Vdc R=50 kΩ	
19	220,01 Vdc R=10 MΩ	
20	100,25Vdc R=200 kΩ	
21	10 mAdc	 <p>PE: CX1651_+I M: CX1651_-I</p>
22	100 mAdc	
23	10 mA 49 Hz	 <p>L: CX1651_+I PE: CX1651_-I</p>
24	50 Vdc power supply (1 mA and 30 mA)	 <p>50 Vdc - + N PE L</p> <p>L: Alim_Hi PE: Alim_Lo</p>
	50 Vdc power supply (50 mA and 300 mA)	
25		 <p>N, PE, L: not connected</p>

## 8. WARRANTY

---

Except as otherwise stated, our warranty is valid for **24 months** starting from the date on which the equipment was sold. The extract from our General Terms of Sale is available on our website.

[www.chauvin-arnoux.com/en/general-terms-of-sale](http://www.chauvin-arnoux.com/en/general-terms-of-sale)

The warranty does not apply in the following cases:

- Inappropriate use of the equipment or use with incompatible equipment.
- Modifications made to the equipment without the explicit permission of the manufacturer's technical staff.
- Work done on the device by a person not approved by the manufacturer.
- Adaptation to a particular application not anticipated in the definition of the equipment or not indicated in the user's manual.
- Damage caused by shocks, falls, or floods.



