

Digital limit switch, model EGS80

EN



Part of your business

Digital limit switch, model EGS80

With regard to the supply of products, the current issue of the following document is applicable:
The general terms of delivery for products and services of the electrical industry, as published
by the central association of the "Elektrotechnik und Elektroindustrie (ZVEI) e.V.",
including the supplementary clause "Extended reservation of title".

1	Symbols Used	3
2	Overview	4
2.1	Range of Application	4
3	Safety Instructions	5
4	Installation and Connection	6
4.1	Installation	6
4.2	Connection	7
4.2.1	Connection Input (Field Circuit)	8
4.2.2	Connection Output	9
4.3	Field Device Communication via HART	10
4.4	Front Side	10
5	Display Modes and Fault Messages	11
6	Editing Device Data	12
6.1	Parameterization Mode	12
6.1.1	Invocation	12
6.1.2	Password	13
6.1.3	Navigation Method	14
6.1.4	Lowest Menu Level: Select Values, Enter Numeric Values	15
6.2	Unit	16
6.3	Input	17
6.3.1	Line Monitor	18
6.3.2	Zero Point and Conversion Factor	18
6.3.3	Linerization	22
6.3.4	Smoothing	22

6.4	Relays	23
6.4.1	Operating Behaviour	24
6.4.2	Trip and Hysteresis	26
6.4.3	Alarm Freeze	26
6.4.4	Delay	26
6.5	Current Output	28
6.5.1	Characteristic	29
6.5.2	Fault Current	31
6.5.3	Start Value and End Value	31
6.6	Service	32
6.7	Default Settings	33

1 Symbols Used



Warning

This symbol warns of possible danger.

Failure to heed this warning may result in personal injury or death, or property damage, including destruction.



Attention

This symbol warns the user of a possible fault.

Failure to heed this warning can lead to total failure of the device and any other connected equipment.



Note

This symbol draws attention to important information.

2 Overview

2.1 Range of Application

The devices are used for transmitting signals between field devices and a process control system/control system.

Transmitters are measuring units that provide an output signal consisting of a unit current signal (4 mA to 20 mA). A transmitter power supply provides a transmitter with power and processes the current signal.

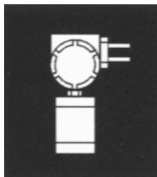

The device converts a fully parameterizable portion of the input signal into a proportional output current (4 mA to 20 mA).

This output signal will be transferred to indicators or to analogue inputs on the process control system/control system, for example.

Both relay outputs of the device can monitor two fully parameterizable trip values of the input signal.

More information can be found on certificates and datasheets.

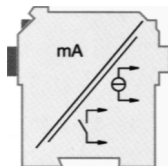

3 Safety Instructions



Warning

The device may only be operated by trained professionals in a manner corresponding to this operating manual.



Warning

The protection of operating personnel and of the system is only ensured if the devices are used in accordance with their intended purpose. Any other type of operation than that described in this manual places the safety and functionality of the devices and systems connected to them in question.



Warning

*The devices may only be installed, connected, and adjusted by electrical professionals **outside the hazardous area.***



Warning

If faults cannot be eliminated, the devices must be taken out of operation and protected from being placed in service again inadvertently. Devices must only be repaired directly by the manufacturer. Tampering with or making changes to the devices is dangerous and therefore not permitted. They render the warranty void.



Note

The responsibility for the adherence to local safety standards lies with the operator.

4 Installation and Connection

4.1 Installation



Attention

The device is constructed in protection degree IP20 and must therefore be protected from undesirable ambient conditions (water, small foreign objects).

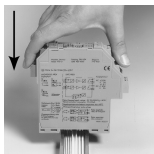

The devices can be mounted on a 35 mm DIN mounting rail according to DIN EN 60715. The devices must be snapped onto the rail **vertically**, and never slanted or tipped to the side.

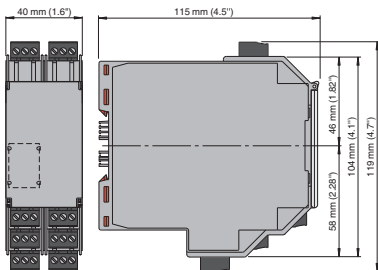

Dimensions of the device in mm

4.2 Connection

The removable terminals of the KF-series considerably simplify the connection and the switch cabinet assembly. They make it possible to replace devices quickly and without fault if a customer service becomes necessary.

Terminals are equipped with screws, are self-opening, have a large connection area for a wire cross-section up to 2.5 mm² and coded plugs, making it impossible to mix them up.

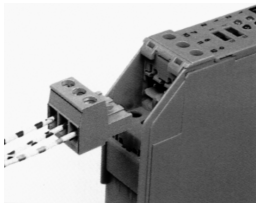

4.2.1 Connection Input (Field Circuit)

The non-intrinsically safe field circuit is connected to the terminals 1 to 3.

In both cases you can connect the following field devices:

1. a 2-wire transmitter
2. an active current source

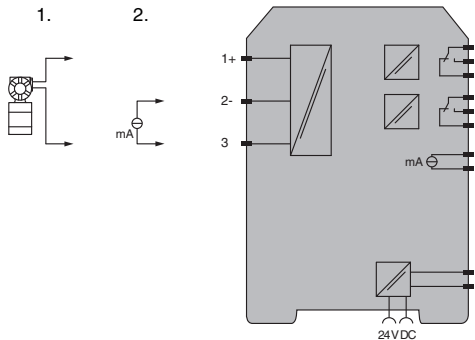

4.2.2 Connection Output

The control circuit and the power supply are connected to terminals 7 to 24 on the device.

The terminals have the following functions:

- Terminals 7/8: current output (terminal 9 not used)
- Terminals 10 to 12: relay 1
- Terminals 16 to 18: relay 2
- Terminals 23/24: (terminal 22 not used) AC/DC power supply

Terminals 4 to 6, 13 to 15 and 19 to 21 do not exist.

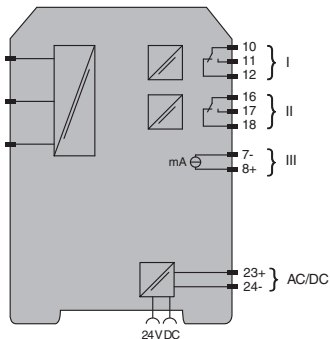

4.3 Field Device Communication via HART

In order to set the parameters of the connected HART field device, you will require a HART communicator which you can connect to the field cables. Transmitting the HART signal via the current output of the device is not possible.

4.4 Front Side

The following indicating and operating elements are located on the front of the device:

- LED CHK (red) to indicate a device fault
- LED PWR (green) to indicate the presence of the supply voltage
- LED OUT 1 (yellow) to indicate that relay 1 is active
- LED OUT 2 (yellow) to indicate that relay 2 is active
- Display for indication of the measured values, fault messages and parameterization mode
- Four keys for setting the parameters of the device:
▲ (Up) ▼ (Down) ESC (Escape) OK
- Interface for connecting a computer for parameterization and diagnostics of the device with the parameterization software, using a adapter

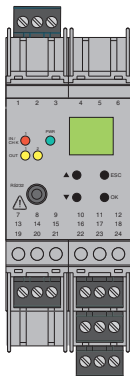

5 Display Modes and Fault Messages

In normal operation, the current measured value is indicated in the selected unit.

For information on selecting the unit, see section 6.2.

If the Alarm freeze (see section 6.4.3) is triggered but the device continues operating normally, a corresponding message appears in the second line of the display.

If a fault occurs, one of the following messages is displayed until the fault is rectified (when parameterized):

- *Err Mem* for device fault,
- *Err LB* for lead breakage,
- *Err SC* for short circuit

For the selection of fault messages see section 6.3.1.

If switching the device on/off and checking the cables does not rectify the fault, please contact Pepperl+Fuchs or the field device manufacturer.

The relays de-energizes when a fault occurs.

For information on the behaviour of the current output in the event of fault, see section 6.5.2.



Note

The display of the device is updated at regular intervals. This can causes a short flickering of the display. This flickering isn't a defect of the display.

6 Editing Device Data



Warning



Note

*A change in device data will change the operation of the device!
Before entering new data into the device, you should ascertain that no danger to the installation will result.*

*In this manual, the parameterization of the device via the control panel is described.
Parameterization by means of a PC is more convenient.*

6.1 Parameterization Mode

6.1.1 Invocation

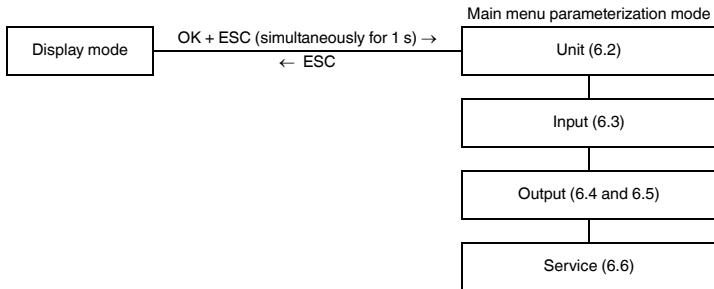

You can return to display mode from any point in the menu in parameterization mode by pressing the ESC key (possibly multiple times). If you do not press any key for 10 minutes in parameterization mode, the device automatically switches back into display mode.

6.1.2 Password

You can protect the parameterization from unauthorized changes by means of a password (see section 6.6; at the delivery of the device, the password is inactive).

If the password protection is active, you can view the different settings in the parameterization mode, but not change them before entering the password. On the first attempt to make a change, the device immediately prompts for a password.

The password must be entered for **each** transition from display mode to parameterization mode, **once** each time.

The password cannot be changed. It is **1234**.

The password is entered as follows:

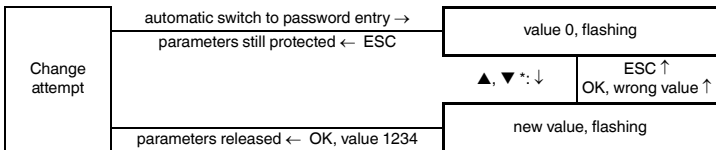

* If you press the ▲ or ▼ key, the value changes step by step. If you hold the ▲ or ▼ key, the setting "rolls" to higher or lower values.

6.1.3 Navigation Method

The following diagram shows the navigation method in parameterization mode using the ▲, ▼, OK and ESC keys:

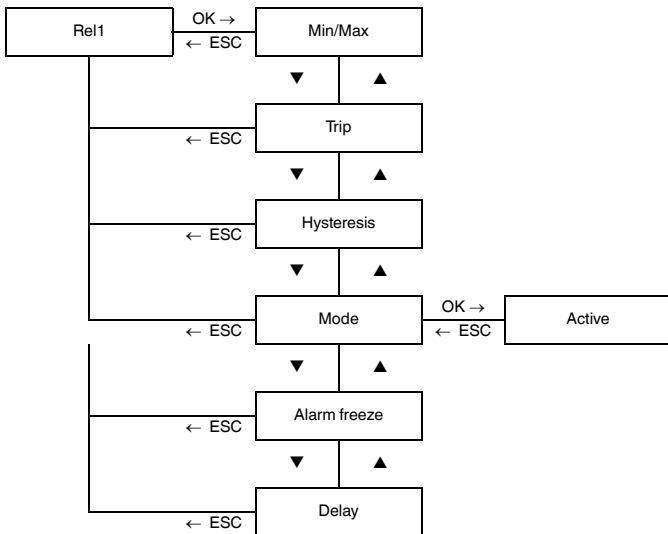

6.1.4 Lowest Menu Level: Select Values, Enter Numeric Values

On the lowest level of the menu, you can either select one of several possible values, or enter a number for the individual parameters.

Proceed as follows:

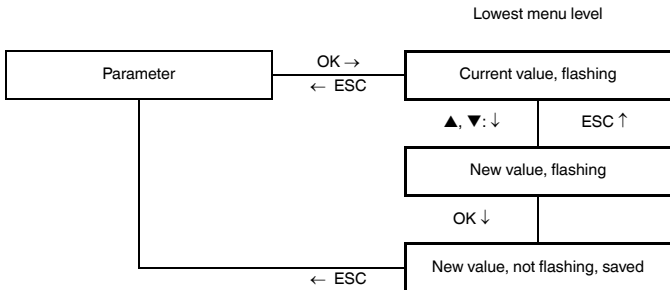

When entering *numeric values*, please note:

- If you press the ▲ or ▼ keys, the value changes step by step.
- If you hold the ▲ or ▼ keys, the value "rolls" to higher or lower values.
- The algebraic sign changes automatically.
- The decimal point is moved automatically.

6.2 Unit

The following diagram shows the unit menu. Items from the lowest menu level are outlined in bold. The device measures in mA. Using the parameters zero point and conversion factor (section 6.3.2) it converts the measured value into the selected units. These units are used for the display of the measured values and for all corresponding settings in the parameterization mode.

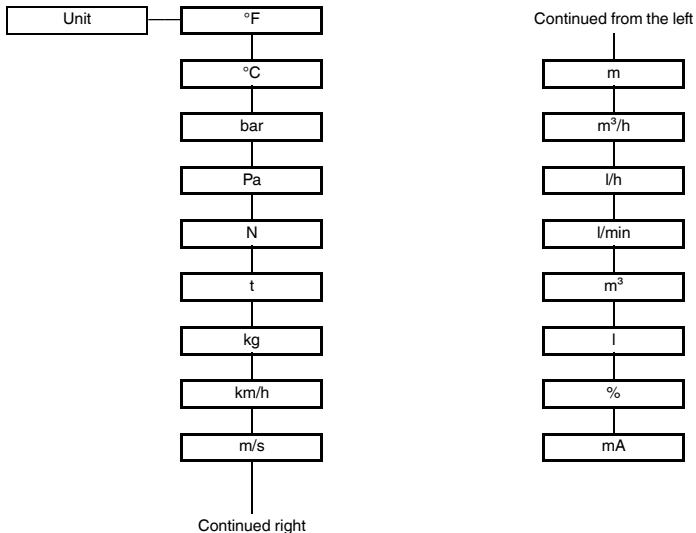

6.3 Input

The following diagram shows the input parameters menu. Items from the lowest menu level are outlined in bold.

The menu items *Zero point* and *Conversion factor* will **not** be shown if the unit mA is selected (section 6.2).

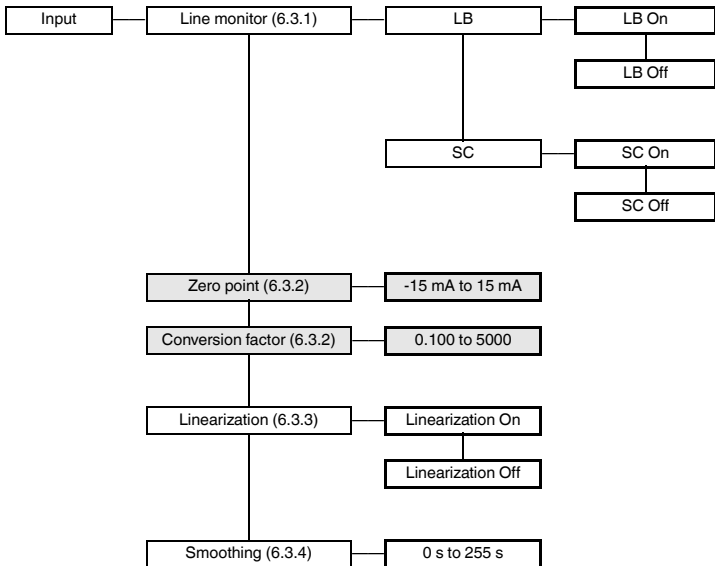

6.3.1 Line Monitor

- If you select *On* for *LB*, an input current < 0.2 mA will be registered as a lead break (section 5).
- If you select *On* for *SC*, an input current > 22 mA will be registered as a short circuit (section 5).

If you wish to process the ≤ 0.2 mA input values as measured values, you must deselect the lead breakage detection (*Off LB*). If not, an fault will be signalled within the measuring range.

6.3.2 Zero Point and Conversion Factor

The device measures in mA. If you have selected different *units* (section 6.2), the device calculates the measured value in the selected units using the parameters *Zero point* and *Conversion factor*.

The parameters for your application must be determined according to the following formula:

Measured value in the selected units = (Original measured value [mA] – Zero point) x Conversion factor

An arbitrary value between -15 mA and +15 mA can be set as the *Zero point*, and values between 0.100 and 5000 as the *Conversion factor*.

The following includes examples where the formulas are applied.

Example 1: selected unit °C, 0 °C to 200 °C is to correspond to 4 mA to 20 mA

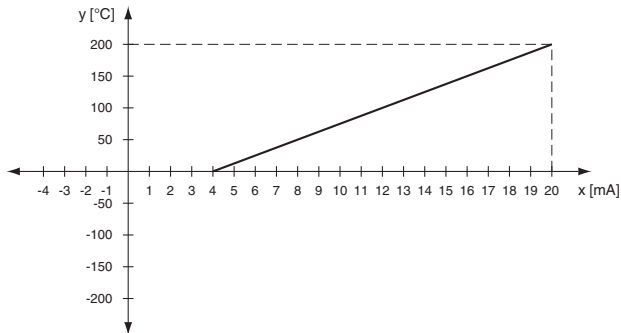

- Linearization
 $y = m x + n$
- Conversion factor = rise in the graph
 $m = (y_2 - y_1) / (x_2 - x_1)$
 $m = (200 - 0) / (20 - 4) = 12.5$
- Zero point = intersection point with the x-axis on the graph, providing that the physical measuring range starts from 0 ($y = 0$ °C). The zero point corresponds to the lower measuring range limit ($x = 4$ mA) from which the measuring range starts.

The zero point can be calculated as follows:

$$n = y - m x$$

$$n = 200 - 12.5 \times 20 = -50$$

$$y = m x + n$$

$$x = (y - n) / m$$

$$x = (0 + 50) / 12.5 = 4$$

Example 2: selected unit °C, 0 °C to -100 °C is to correspond to 20 mA to 0 mA

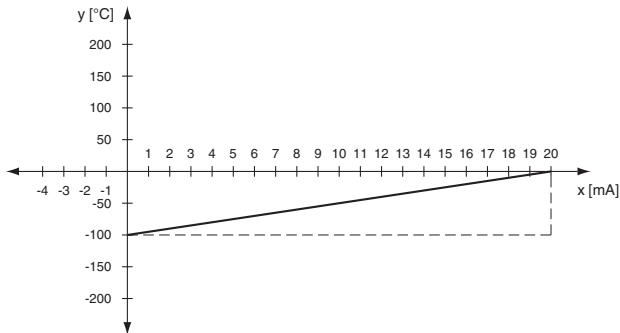

- Linearization
 $y = m x + n$
- Conversion factor = rise in the graph
 $m = (y_2 - y_1) / (x_2 - x_1)$
 $m = (100 - 0) / (20 - 0) = 5$
- Zero point = intersection point with the x-axis on the graph, with the condition that the physical measuring range starts from 0 ($y = 0$ °C). The zero point corresponds to the upper measuring range limit ($x = 20$ mA) at which the measuring range ends.

The zero point can be calculated as follows:

$$n = y - m x$$

$$n = -100 - 5 \times 0 = -100$$

$$y = m x + n$$

$$x = (y - n) / m$$

$$x = (0 + 100) / 5 = 20$$

Example 3: selected unit bar, -4 bar to 4 bar is to correspond to 4 mA to 20 mA

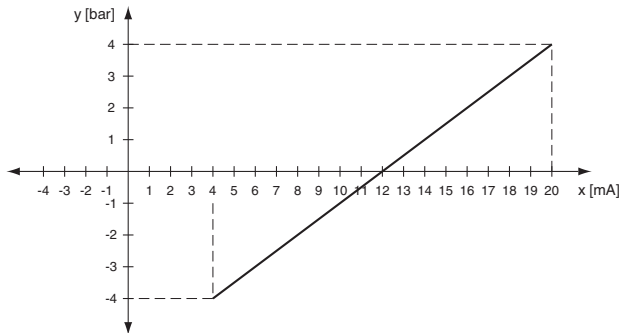

- Linearization
 $y = m x + n$
- Conversion factor = rise in the graph
 $m = (y_2 - y_1) / (x_2 - x_1)$
 $m = (4 - 0) / (20 - 12) = 0.5$
- Zero point = intersection point with the x-axis on the graph (bar value at $y = 0$)
 $n = y - m x$
 $n = 4 - 0.5 \times 20 = -6$
 $y = m x + n$
 $x = (y - n) / m$
 $x = (0 + 6) / 0.5 = 1$

6.3.3 Linerization

Using the parameterization software a linearization table can be saved in the device; for details of this function see On-line help. Via the operator panel you can merely switch the use of the table for the calculation of the output value on and off (On/Off).

6.3.4 Smoothing

For extremely variable measurement values, you can use *Smoothing* to influence how quickly an output reacts to a change in input value: 0 s = no smoothing, 255 s = maximum smoothing.

6.4 Relays

The following diagram shows the relay outputs menu. Items from the lowest menu level are outlined in bold.

From the *Rel1* and *Rel2* menu options, you can use the OK key to get to a menu in which you can enter individual parameters for the selected relay. Both menus are structured in the same way and are thus only described once. Information about current output see section 6.5.

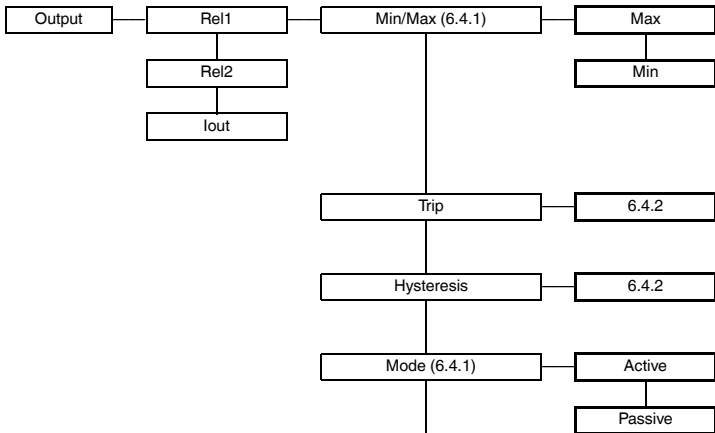

Continued on next page

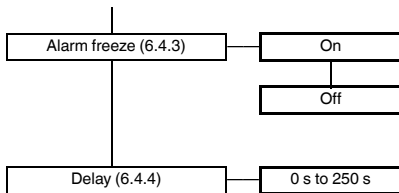

6.4.1 Operating Behaviour

The switching direction can be set as *Max* or *Min* and the direction of action as *Active* or *Passive* (section 6.4).

Application ranges:

- Switching direction *Max*, mode of operation *Active*:
alarm on trip value overrange, e. g. audible alarm on
- Switching direction *Max*, mode of operation *Passive*:
switch off on trip value overrange, e. g. pump, heating, ... off;
with large hysteresis Min/Max operation (pump, heating, ... on/off)
- Switching direction *Min*, mode of operation *Active*:
alarm on trip value underrange, e. g. audible alarm on
- Switching direction *Min*, mode of operation *Passive*:
switch off on trip value underrange, e. g. pump, heating, ... off;
with large hysteresis Min/Max operation (pump, heating, ... off/on)

The exact operating behaviour of the device is shown in the following diagram:

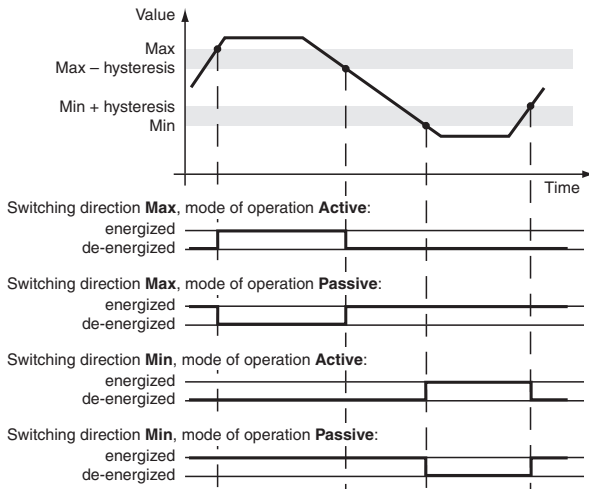

6.4.2 Trip and Hysteresis

When entering the values for *Trip* and *Hysteresis* please note:

- Both values are to be entered in the units, which were selected under *Units* (section 6.2).
- You can enter values
 - between 0 mA and 24 mA and
 - between the converted values of these limits in the selected units; for conversion using the parameters *Zero point* and *Conversion factor* see section 6.3.2
- The hysteresis must be selected as > 1 % of the trip point to prevent the relay from vibrating.
- As the representation of the operating behaviour in section 6.4.1 shows, the following must apply:
 - for the switching direction *Max*: Trip point - Hysteresis ≥ 0
 - for the switching direction *Min*: Trip point + Hysteresis \leq upper limit trip point

These input limits are automatically preset by the device.

6.4.3 Alarm Freeze

The *Alarm freeze* helps you to avoid that short-term trip value overranges are not noticed by the operating staff.

If *Alarm freeze On* has been selected, the new state is maintained after the relay switching until the ESC key is pressed or the device is restarted. These actions reset the relay, except for a trip value overrange.

6.4.4 Delay

If you set a time > 0 sec, you prevent short-time trip value overranges of the trip value from triggering an alarm.

- The relay only switches if the trip point is exceeded/fallen short of for a period that is longer than the delay time.
- The relay only switches back if the trip point -/+ hysteresis is fallen short of/exceeded for a period that is longer than the delay time.
- If the trip point is exceeded/fallen short of for a short time, this does not have any effects.
- You can adjust the delay time from 0 s to 250 s.

The following diagram shows the operating behaviour for the trip mode *Max*, operating mode *Active*.

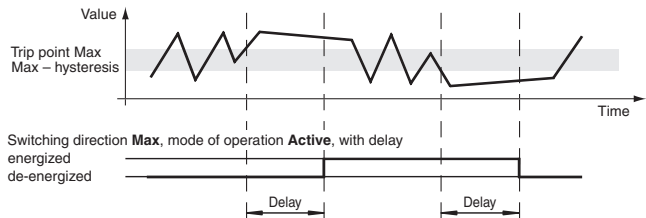

6.5 Current Output

The following illustrations show the current output menus. Items from the lowest menu level are outlined in bold. Information about relay outputs see section 6.4.

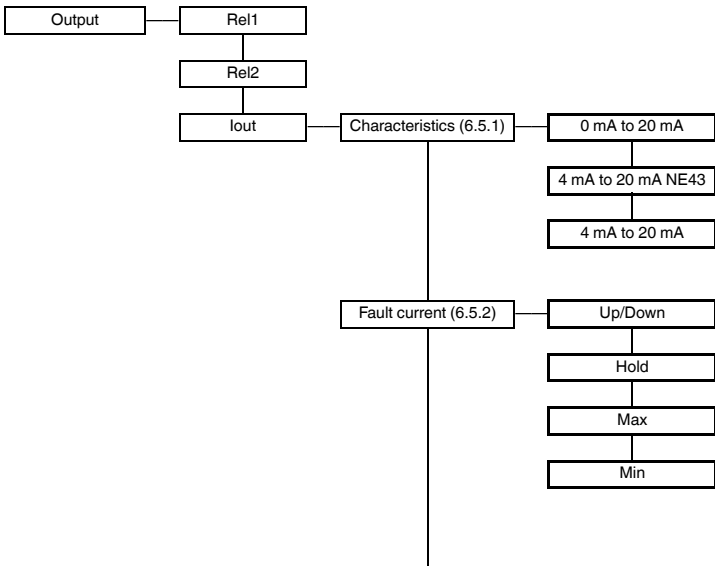

Continued on next page

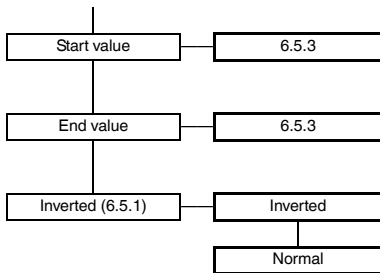

6.5.1 Characteristic

With the parameters *Start value* and *End value* establish a sub-range of the input signal as the measuring range of the application (section 6.5.3). This measuring range is formed linearly on the output signal.

The following table shows, for the various characteristics (section 6.5), the conversion of the *Start value* and *End value* and the behaviour during measuring overrange.

- The statements apply for the setting *Inverted* → *Normal*.
- If you select *Inverted* → *Inverted*, the conversion of *Start value* and *End value* are reversed. The start value is thus converted to 20 mA and the end value to 0 mA or 4 mA.
- Measuring overrange, which extend over the described linear range, cannot be evaluated. In the case of such overrange, the specified value is constantly output.

Characteristic	Start value converted into	End value converted into	Linear underrange up to	Linear overrange up to
0 mA to 20 mA	0 mA	20 mA	0 mA	20.5 mA
4 mA to 20 mA NE43	4 mA	20 mA	3.8 mA	20.5 mA
4 mA to 20 mA	4 mA	20 mA	0 mA	approx. 22 mA

Example of a diagram of a mA measurement range on the output signal

Characteristic 4 mA to 20 mA NE43, start value 2 mA, end value 10 mA

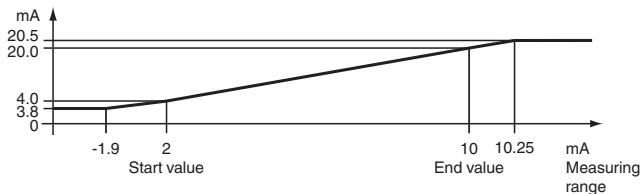

Example diagram displaying the input signal in °C to the output signal

Characteristic 4 mA to 20 mA NE43, start value 0 °C, end value 200 °C (see example 1 in section 6.3.2)

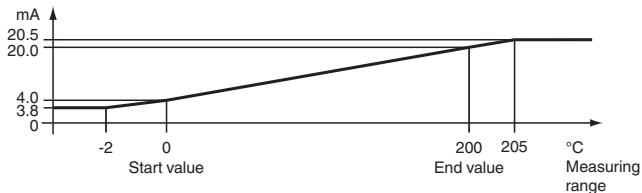

6.5.2 Fault Current

The following table shows the current output in the event of a fault, depending on the characteristic.

Setting	0 mA to 20 mA	4 mA to 20 mA NE43	4 mA to 20 mA
Up/Down	21.5 mA with short-circuit	21.5 mA with short-circuit	22 mA with short-circuit (not distinguishable from <i>End value</i> overrange)
	0 mA with lead breakage (not distinguishable from <i>Start value</i> measurement)	2.0 mA with lead breakage	0 mA with lead breakage (not distinguishable from <i>Start value</i> underrange)
Hold	Last measured value before the fault		
Max	21.5 mA	21.5 mA	22 mA (not distinguishable from <i>End value</i> overrange)
Min	0 mA (not distinguishable from <i>Start value</i> measurement)	2.0 mA	0 mA (not distinguishable from <i>Start value</i> underrange)

6.5.3 Start Value and End Value

Please note when entering *Start value* and *End value*:

- Both values are to be entered in the units, which were selected under *Units* (section 6.2).
- Values between 0 mA and 20 mA can be entered, or between the values of these limits converted into the selected units, using the parameters *Zero point* and *Conversion factor* see section 6.3.2

The difference between *End value* and *Start value* must be at least 1 % of the *End value* (preset automatically by the device).

6.6 Service

The following diagram shows the service parameter menus. Items from the lowest menu level are outlined in bold.

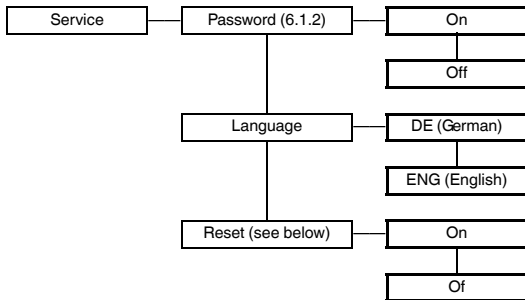

Reset: Pressing the OK key when *On Reset* is flashing resets all settings on the device to default (see section 6.7). Any entries that you have made in parameterization mode are lost.

6.7 Default Settings

Menu	Parameter	Default setting	Separate value
Main menu	Unit	mA	
Input	Line monitor	On LB/On SC	
	Zero point	4.000 mA	
	Conversion factor	0.100	
	Linearization	Off	
	Smoothing	3 s	
Output Rel1	Min/Max (= switching direction)	Min	
	Trip	16.00 mA	
	Hysteresis	2.000 mA	
	Mode	Passive	
	Alarm freeze	Off	
	Delay	0 s	
Output Rel2	Min/Max (= switching direction)	Min	
	Trip	2.000 mA	
	Hysteresis	2.000 mA	
	Mode	Active	
	Alarm freeze	Off	
	Delay	0 s	
Output Iout	Characteristics	4 mA to 20 mA NE43	

Menu	Parameter	Default setting	Separate value
	<i>Fault current</i>	<i>Min</i>	
	<i>Start value</i>	<i>0.000 mA</i>	
	<i>End value</i>	<i>20.00 mA</i>	
	<i>Inverted</i>	<i>Normal</i>	
<i>Service</i>	<i>Password</i>	<i>Off</i>	
	<i>Language</i>	<i>ENG</i>	

