

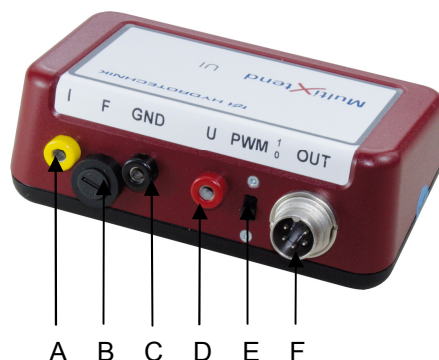



MultiXtend UI

Technisches Datenblatt
Technical Data Sheet

	<p>MultiXtend UI 316A-A0-00.xx</p>	<p>± 30 VDC / ± 2 ADC \rightarrow 0...20 mA ± 60 VDC / ± 4 ADC \rightarrow 0...20 mA</p>
	<p>Strom- /Spannungsadapter zur Umsetzung von ± 30 VDC / ± 2 ADC oder ± 60 VDC / ± 4 ADC auf Normsignal</p>	<p><i>current-/voltage adaptor to transform ± 30VDC / ± 2ADC or ± 60 VDC / ± 4 ADC to standardized signals</i></p>
<p>Beschreibung <i>Description</i></p>	<p>Der MultiXtend UI ist ein Adapter zur Umwandlung von Strom und Spannung auf das Normsignal 0...20 mA. Es können damit positive und negative Spannungen / Ströme gemessen werden. Der Nullpunkt liegt bei 10 mA.</p>	<p><i>The MutliXtend UI is an adaptor to transform current and voltage to the standardized signal 0...20 mA. It is possible to measure positive and negative voltages / currents. The zero point is at the signal level of 10 mA.</i></p>
<p>Eigenschaften <i>Qualities</i></p>	<ul style="list-style-type: none"> • Ausgangssignal 0...20 mA • Hochohmiger oder niederohmiger Spannungseingang • Niederohmiger Stromeingang • Galvanische Trennung von Ein- und Ausgang • Zuschaltbarer Hardwarefilter für PWM-Signal • Temperaturbereich -20 ...+85°C • Kompatibel zu allen Hydrotechnik Messgeräten 	<ul style="list-style-type: none"> • <i>output signal 0...20 mA</i> • <i>high-impedance voltage or low-impedance input</i> • <i>low-impedance current input</i> • <i>input and output galvanically isolated</i> • <i>switchable hardware filter for PWM-signals</i> • <i>temperature range -4...+185°F</i> • <i>compatible with all Hydrotechnik measuring instruments</i>
<p>Verwendungszweck <i>Designated use</i></p>	<p>Messung höhere Spannungen und Ströme mit Messgeräten, die nur Standardsignaleingänge besitzen.</p>	<p><i>Measure higher voltages und currents with measuring instruments that have inputs for standardized signals only.</i></p>

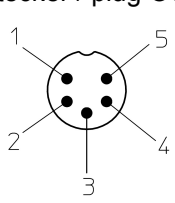
**Elektrische Verbindungen
Electrical connections**

- A: Stromeingang / *current input*
 B: Sicherungshalter für Feinsicherung / *Fuse holder for microfuse*
 C: Masse / *ground*
 D: Spannungseingang / *voltage input*
 E: Schalter für Hardwarefilter(PWM-Filter) / *switch to activate hardware filter(PWM filter)*
 F: Anschluss zum Messgerät / *connection to measuring instrument*

Pinbelegungen <i>Pin assignments</i>	Bezeichnung <i>Labeling</i>	Nr. <i>No</i>	Funktion	<i>Function</i>
Rundsteckverbinder M16 x 0.75 mit Schraubverriegelung, Ausführung 05-a, 5-polig, Stecker <i>Circular connectors M16 x 0.75 with screw-locking Layout 05-a, 5 poles, male IEC / DIN EN 61076-2-106</i>				
Stecker / plug OUT  M16 5p m	Signal	1	Signal	<i>signal</i>
	GND Ub/Signal	2	Versorgungs- und Signalmasse	<i>supply and signal ground</i>
	+Ub	3	Versorgung +	<i>supply +</i>
	NC	4	nicht verbunden	<i>not connected</i>
	NC	5	nicht verbunden	<i>not connected</i>
BIL 20 Buchse mit Isolierkopf und -ring zum Einbau, für 4 mm Stecker gelb <i>Socket with insulated head and ring for installation, for 4 mm plug yellow</i>				
Buchse / jack 	I	1	Stromeingang	<i>current input</i>
BIL 20 Buchse mit Isolierkopf und -ring zum Einbau, für 4 mm Stecker rot <i>Socket with insulated head and ring for installation, for 4 mm plug red</i>				
Buchse / jack 	U	1	Spannungseingang	<i>voltage input</i>
BIL 20 Buchse mit Isolierkopf und -ring zum Einbau, für 4 mm Stecker schwarz <i>Socket with insulated head and ring for installation, for 4 mm plug black</i>				
Buchse / jack 	GND	1	Masse	<i>ground</i>

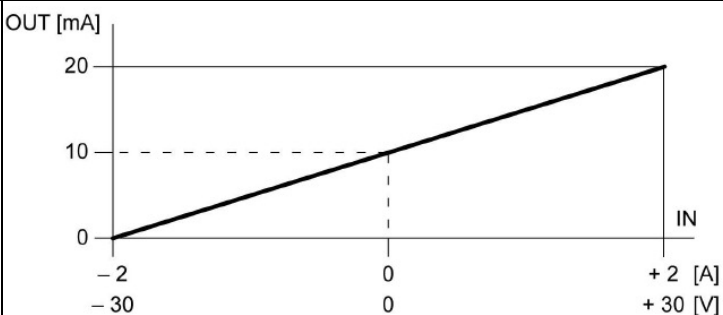
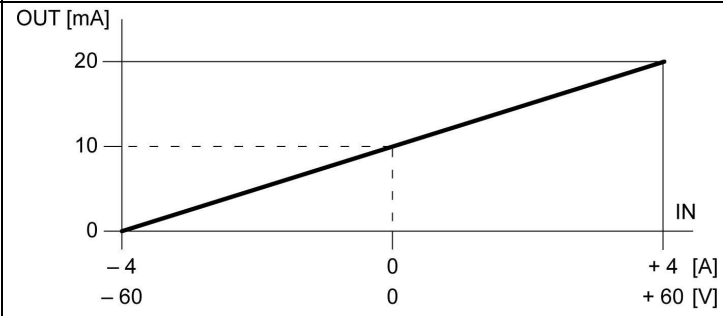
Sicherungshalter für Feinsicherung / Fuse holder for microfuse			
	F_1	M2A für Ausgang von ± 30 VDC / ± 2 ADC M4A für Ausgang von ± 60 VDC / ± 4 ADC	M2A for output of ± 30 VDC / ± 2 ADC M4A for output of ± 60 VDC / ± 4 ADC
Einstellung im Messgerät Setting in measuring instrument ± 30 VDC / ± 2 ADC \rightarrow 0...20 mA			
	A) Kalibrierwert / calibration value : I = 4A oder / or U = 60V Durchführung eines Nullpunktgleichs ohne Signal notwendig / <i>zero point alignment without signal is necessary</i>		
	B) Messbereich / measuring range : I = -2A ...+2A oder / or U = -30V ... +30V		
Einstellung im Messgerät setting in measuring instrument ± 60 VDC / ± 4 ADC \rightarrow 0...20mA			
	C) Kalibrierwert / calibration value : I = 8A oder / or U = 120V Durchführung eines Nullpunktgleichs ohne Signal notwendig / <i>zero point alignment without signal is necessary</i>		
	D) Messbereich / measuring range : I = -4A ...+4A oder / or U = -60V ... +60V		

Absolute Grenzwerte Absolute maximum rating	Min	Typ.	Max	Einheit Unit	Symbol Icon	Bemerkung Remarks
Versorgungsspannung / Supply voltage	13		30	VDC	V+	Ta=25°C Ta=77°F
Betriebstemperatur / operating temperature	-20 (-4)		85 (185)	°C (°F)	To	
Lagertemperatur / storage temperature	-40 (-40)		125 (257)	°C (°F)	Ts	
Relative Feuchte / relative humidity	0		80	%	r.F.	Nicht betauend / not condensing

Elektrische Eigenschaften Electrical qualities	Referenzbedingungen / <i>Reference conditions</i> : Umgebungstemperatur $T_a=25^{\circ}\text{C}$ / <i>environmental temperature $T_a=77^{\circ}\text{F}$</i>				
Parameter	Min	Typ.	Max	Einheit Units	Bemerkung Remarks
Versorgungsstrom / <i>supply current</i>		40		mA	ohne Signal / <i>without signal</i>
± 30 VDC / ± 2 ADC \rightarrow 0...20 mA Hochohmig / <i>high impedance</i>					
Eingangssignal Strom / <i>input signal current</i>	-2		2	ADC	
Eingangssignal Spannung / <i>input signal voltage</i>	-30		30	VDC	
Fehlergrenzen Eingangssignal / <i>error limits input signal</i>			1	%FS	
Eingangswiderstand Strom / <i>input impedance current</i>		0.1		Ω	Toleranz $\pm 5\%$ <i>tolerance $\pm 5\%$</i>
Eingangswiderstand Spannung / <i>input impedance voltage</i>		10'000		k Ω	Toleranz $\pm 5\%$ <i>tolerance $\pm 5\%$</i>
± 60 VDC / ± 4 ADC \rightarrow 0...20 mA Niederohmig / <i>low impedance</i>					
Eingangssignal Strom / <i>input signal current</i>	-4		4	ADC	
Eingangssignal Spannung / <i>input signal voltage</i>	-60		60	VDC	
Fehlergrenzen Eingangssignal / <i>error limits input signal</i>			1	%FS	
Eingangswiderstand Strom / <i>input impedance current</i>		0.05		Ω	Toleranz $\pm 5\%$ <i>tolerance $\pm 5\%$</i>
Eingangswiderstand Spannung / <i>input impedance voltage</i>		60		k Ω	Toleranz $\pm 5\%$ <i>tolerance $\pm 5\%$</i>
Temperaturfehler / <i>temperature error</i>	-0.03		+0.03	%/ $^{\circ}\text{C}$	
Einschwingzeit ohne PWM-Filter / <i>response time without PWM-filter</i>		5		ms	Signalsprung von 10 auf 90 % vom Endwert / <i>signal change from 10 to 90 % of full scale</i>
Einschwingzeit mit PWM-Filter / <i>response time with PWM-filter</i>		250		ms	Signalsprung von 10 auf 90 % vom Endwert / <i>signal change from 10 to 90 % of full scale</i>
Galvanische Trennung / <i>galvanic isolation</i>			70	VDC	

Mechanische Eigenschaften Mechanical characteristics	
Gehäuse / <i>Casing</i>	Kunststoff mit EMV Beschichtung / <i>Plastic with EMC coat</i>
Schutzart / <i>IP protection class</i>	IP 40
Gewicht / <i>Weight</i>	190g

MultiXtend UI

Technisches Datenblatt
Technical Data Sheet

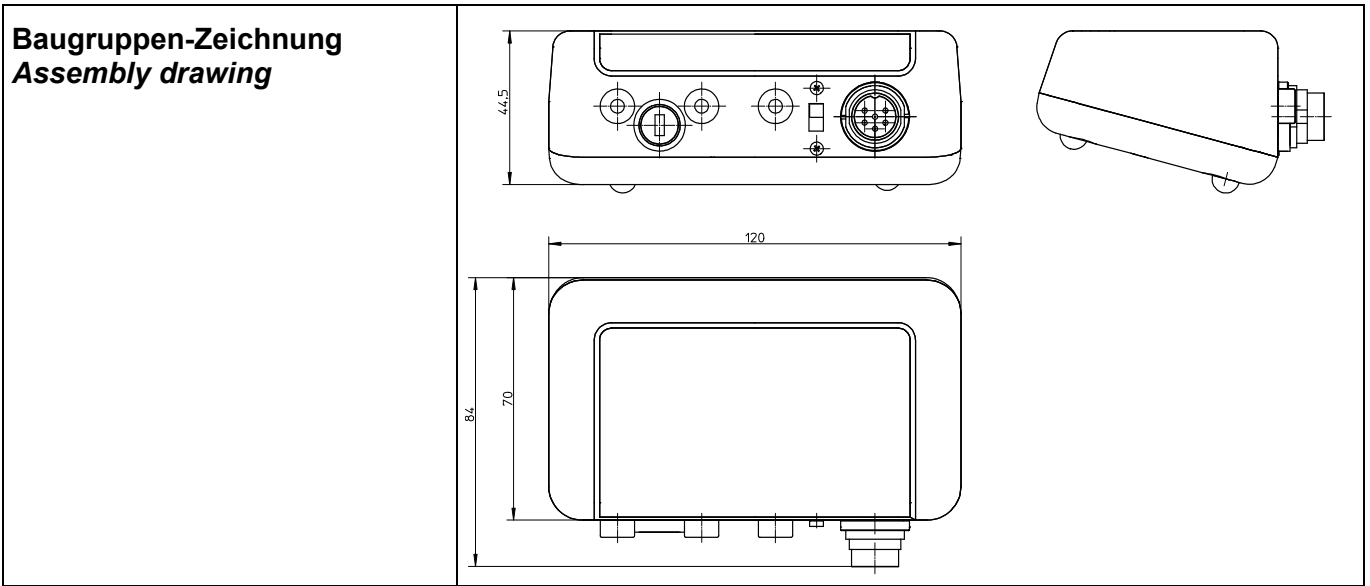

Verpackung / Packing	MultiXtend UI wird in einem Karton verpackt geliefert. <i>MultiXtend UI is delivered in a box.</i>
-----------------------------	---

Typenschild <i>Type plate</i>	<div data-bbox="699 1077 1426 1458"> <p>MultiXtend UI CE</p> <p>Bestell-Nr. / Part-No. 316A-A0-00.20 Eingangssignal / Input $\pm 2A/\pm 30V$ Ausgangssignal / Output 0 ... 20mA Versorgungsspannung / Supply voltage 13 ... 30 VDC Werk-Nr. / Serial-No 02187</p> <p>HYDROTECHNIK MESSEN MIT SYSTEM</p>  </div> <div data-bbox="699 1503 1426 1883"> <p>MultiXtend UI CE</p> <p>Bestell-Nr. / Part-No. 316A-A0-00.30 Eingangssignal / Input $\pm 4A/\pm 60V$ Ausgangssignal / Output 0 ... 20mA Versorgungsspannung / Supply voltage 13 ... 30 VDC Werk-Nr. / Serial-No 00217</p> <p>HYDROTECHNIK MESSEN MIT SYSTEM</p>  </div>
---	---

MultiXtend UI

Technisches Datenblatt
Technical Data Sheet

TKZ / order number	Eingangssignal / input signal	Bemerkung / remarks
316A-A0-00.20	± 30 VDC / ± 2 ADC	Hochohmig / high impedance
316A-A0-00.30	± 60 VDC / ± 4 ADC	Niederohmig / low impedance

Europäische Konformität European Conformity	CE	
Elektromagnetische Verträglichkeit / <i>electromagnetic compatibility</i>	Richtlinie 2004/108/EG	<i>Directive 2004/108/EC</i>

Haftungsausschluss / Limitation of Liability	<p>Hydrotechnik behält sich Änderungen an diesem Dokument vor, ohne vorherige Information. Im Zweifelsfall gilt die deutsche Sprachversion. Angaben in Klammern dienen nur zur Information.</p> <p><i>Hydrotechnik reserves the right to modify this document without prior notice. The German language version is valid in any case of doubt. Data in brackets only given for information.</i></p>
---	---

Revision	Rev 01	Rev 02	Rev 03	Rev 04	Rev 05	Rev 06	Rev 07	Rev 08
	26.05.2011	15.08.2012	2014-10-02					
	CF	AK	MM					