



# IDPT 200

## Differential Pressure Transmitter for Process Industry with HART®-Communication

accuracy according to IEC 60770:  
0.075 % FSO

### Differential pressure

from 1 mbar up to 20 bar

### static pressure

max. 400 bar

### Output signal

2-wire: 4 ... 20 mA

### Special characteristics

- ▶ static over pressure 400 bar
- ▶ rangeability max. 100:1
- ▶ aluminium die cast case
- ▶ HART®-communication
- ▶ output signal: linear or square root extraction





### Optional versions

- ▶ ATEX-version  
Ex ia = intrinsically safe version  
Ex d = flameproof enclosure  
(in preparation)
- ▶ LCD

The differential pressure transmitter IDPT 200 has been especially designed for the process industry and can be used for level measurement of closed, pressurized tanks, pump or filter controlling, etc.

The possibility passes different pressure seals at the IDPT 200 adding with different membrane materials to reach an optimal adaptation to the application.

### Preferred areas of use are

-  Oil and gas industry
-  Chemical and petrochemical industry
-  Energy Industry
-  Food and beverage
-  Paper Industry



Differenzdruckbereiche						
sensor	Type	A	B	C	D	E
Differential pressure range dp [bar]		10 mbar	60 mbar	400 mbar	2.5 bar	20 bar
Setting limits (offset and span in this range freely adjustable)		-10 ... 10 mbar	-60 ... 60 mbar	-400...400 mbar	-2.5 ... 2.5 bar	-20 ... 20 bar
Lowest permissible span		1 mbar	2 mbar	4 mbar	25 mbar	200 mbar
Permissible static pressure	optional	70 bar	160 bar	160 bar 400 bar	160 bar 400 bar	160 bar 400 bar
rangeability TD (with respect to the differential pressure range dp)		10:1	30:1	100:1	100:1	100:1

Output signal / Supply	
Standard	2 wire: 4 ... 20 mA / $V_S = 12 \dots 42 V_{DC}$ (with LC-Display / $V_S = 15 \dots 42 V_{DC}$ ) ATEX-version: / $V_S = 15 \dots 28 V_{DC}$
Error signal	Namur NE43 high / low (adjustable)
Performance	
Accuracy <sup>1</sup>	turn-down $\leq 10:1$ : $\leq \pm 0.075 \% \text{ FSO}$ turn-down $> 10:1$ : $\leq \pm [0.075 \times \text{turn-down}] \% \text{ FSO}$ with turn-down = nominal pressure range / adjusted range  (FSO = Full Scale Output)
Influence supply	$\leq 0.001 \% \text{ FSO} / 10 \text{ V}$
Influence static pressure	Type A: $\pm [0,015 \text{ mbar} + 0,1\% \text{ of the adjusted range}] / 40 \text{ bar}$ Type B: $\pm [0,06 \text{ mbar} + 0,075\% \text{ of the adjusted range}] / 160 \text{ bar}$ Type C: $\pm [0,2 \text{ mbar} + 0,05\% \text{ of the adjusted range}] / 160 \text{ bar}$ Type D: $\pm [1,25 \text{ mbar} + 0,05\% \text{ of the adjusted range}] / 160 \text{ bar}$ Type E: $\pm [10 \text{ mbar} + 0,05\% \text{ of the adjusted range}] / 160 \text{ bar}$
Influence installation position	max. 400 Pa (can be compensated about zero-point correction)
Long term stability	Type A: $\leq \pm (0.5\% \times \text{differential pressure range dp}) / \text{year}$ at reference conditions Type B: $\leq \pm (0.2\% \times \text{differential pressure range dp}) / \text{year}$ at reference conditions Type C - E: $\leq \pm (0.1\% \times \text{differential pressure range dp}) / \text{year}$ at reference conditions
Permissible load	without LC-display : $R_{\max} = [(V_S - 12 \text{ V}) / 0.023 \text{ A}] \Omega$ with LC-display : $R_{\max} = [(V_S - 15 \text{ V}) / 0.023 \text{ A}] \Omega$ HART <sup>®</sup> -communication: $R = 230 \Omega \dots 600 \Omega$
Response time T90	Type A: appr. 1.6 s Type B: appr. 0.4 s Type C: appr. 0.2 s Type D: appr. 0.2 s Type E: appr. 0.1 s
damping	electronic : 0.1 ... 60 s plus response time T90

Thermal effects (Offset and Span)	
Temperature range -20 ... +65°C	Type A: $\pm [0.45 \times \text{turn-down} + 0.25]\% \text{ of the adjusted range}$ Type B: $\pm [0.30 \times \text{turn-down} + 0.20]\% \text{ of the adjusted range}$ Type C - E: $\pm [0.20 \times \text{turn-down} + 0.10]\% \text{ of the adjusted range}$
Temperature range -40 ... -20°C or +65 ... +100°C	Type A: $\pm [0.45 \times \text{turn-down} + 0.25]\% \text{ of the adjusted range}$ Type B: $\pm [0.30 \times \text{turn-down} + 0.20]\% \text{ of the adjusted range}$ Type C - E: $\pm [0.20 \times \text{turn-down} + 0.10]\% \text{ of the adjusted range}$

Permissible temperatures	
Environment / storage	without display : -40 ... 85 °C
	with display : -20 ... 65 °C (85°C without function)
Media wetted parts	Silicon oil : -40 ... 100 °C (information: +125°C short time, max. 30 min.)
	Fluorolube oil : -40 ... 100 °C (information: +125°C short time, max. 30 min.)

Electrical protection	
Short-circuit protection	permanent
Reverse polarity protection	no damage, but also no function

Mechanical stability	
One-sided overload	According to the maximum static pressure of differential pressure sensor
Vibration	5 g RMS (25 ... 2000 Hz) according to DIN EN 60068-2-6
Shock	100 g / 1 msec according to DIN EN 60068-2-27

Materials			
Pressure port / flange	standard	stainless steel 304 / 1.4301	others: on request
	option	stainless steel 316 / 1.4401	
Diaphragm	standard	stainless steel 316L	others: on request
	option	Hastelloy® C-276	
Vent and dump valves	standard option	stainless steel 304 / 1.4301	others: on request
Blanking plugs		stainless steel 316 / 1.4401	
Bolts and nuts	standard	stainless steel 304 / 1.4301	others: on request
	option	stainless steel 316 / 1.4401	
Manufacturing label		stainless steel 316 / 1.4401	
Housing	standard	aluminum die cast with epoxy painting (blue)	others: on request
	option	stainless steel 304 / 1.4301	
Seals (media wetted)	standard	FKM (-30...250°C)	others: on request
	option	NBR (-40...125°C), PTFE (-180...250°C)	
Filling fluids	standard	Silicon oil (-40...125°C)	others: on request
	option	Fluorolube oil (-40...125°C)	

Explosion protection	
Approvals AX18-DPT200	<b>IBExU 14 ATEX 1273 X</b> II 1/2G Ex ia IIC T4 Ga/Gb II 2D Ex ia IIIC T 85 °C Db
Safety technical maximum values for intrinsically safe version	Pi = 660 mW, Ui = 28 V, li = 93 mA, Ci 29,7 nF, Li negligible
Approval (flameproof enclosure)	in preparation
Permissible temperatures for environment	-10 ... 60 °C

Miscellaneous	
Display (optionally)	Type : LCD Lines : 2 Digits : 8 Bargraph : 0...100% rotatability : yes, 90°-steps and / or by turn of the electronic case
configuration	- offset / span local via 2 buttons - local configuration with an optional display - complete configuration via HART®
Mounting bracket (optionally)	material CF8M or stainless steel 304 / 1.4401 weight 0,45 kg (inclusive bolts and nuts)
Ingress protection	IP 67
Installation position	any
Weight	Differential pressure transmitter: approx. 3 kg (depending on version)
Current consumption	approx. 23 mA
CE-conformity	EMC Directive: 2004/108/EC

Connections			
Electrical connection	terminal clamps in clamping chamber (for cable-Ø max.2.5 mm²)		
Process connections	Standard	internal thread 1/4" - 18 NPT / fixing 7/16 UNF	others: on request
	option	internal thread 1/4" - 18 NPT / fixing M10 oval flange 1/2" NPT internal thread adapter M20x1,5	

**Wiring diagram**

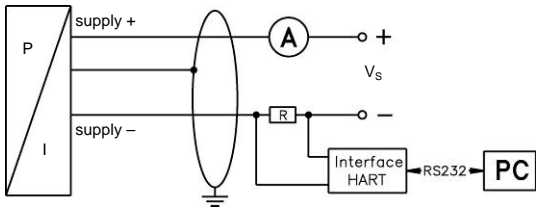

**Pin configuration**

Electrical connection	terminal clamps
Supply + (Vs+)	+
Supply - (Vs-)	-
Test +	TEST+
Ground	⏏

**Dimensions (in mm)**

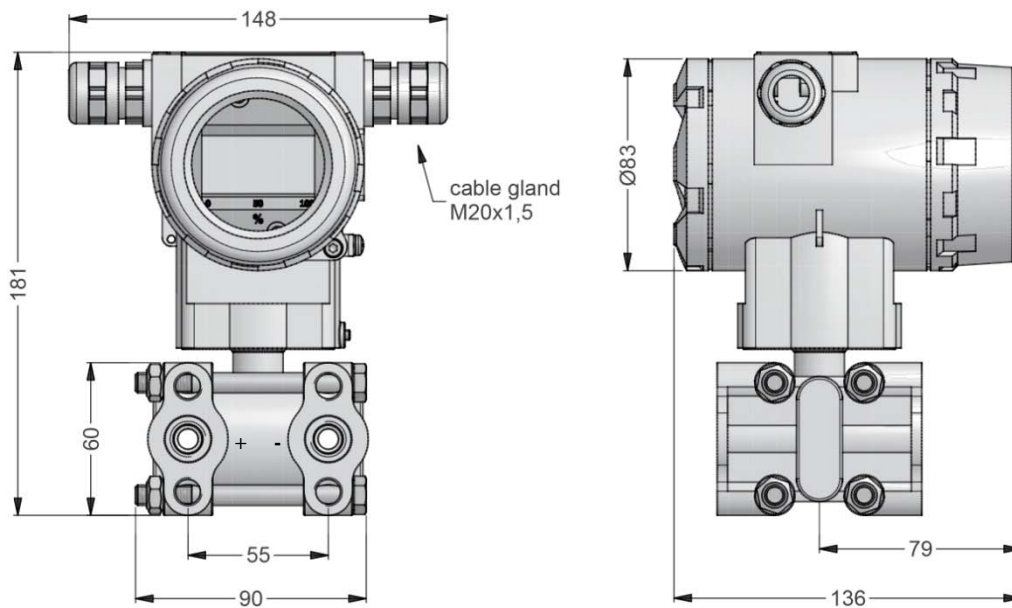

*HART® is a registered trade mark of HART Communication Foundation; Hastelloy® is a brand name of Haynes International Inc. Windows® is a registered trade mark of Microsoft Corporation*

