

## User manual IM2

Pt100 3-/4-wire -200.0°C...850.0°C / -328.0°F...1562.0°F



### Technical features:

- red display of -19999...99999 Digits (optional: green, orange or blue display)
- minimal installation depth: 70 mm without plug-in screw terminal
- min/max-memory
- display flashing at threshold value exceedance / threshold value undercut
- permanent min/max-value recording
- brightness control
- programming interlock via access code
- protection class IP65 at the front side
- plug-in screw terminal
- optional: 2 relay outputs
- optional: analog output
- accessories: PC-based configuration-kit PM-TOOL with CD & USB-adapter for devices without keypad and for a simple adjustment of standard devices

# Identification

STANDARD-TYPES	ORDER NUMBER
Pt100 3-/4-wire	IM2-1TR5B.010C.570xD
Housing size: 96x48 mm	IM2-1TR5B.010C.670xD

## Options – breakdown order code:

	IM	2	-	1	T	R	5	B.	0	1	0	C.	6	7	2	x	D		
<b>Standard type M-line</b>																			<b>Dimension</b>
																			<input type="checkbox"/> physical unit
<b>Installation depth</b>																			<b>Version</b>
89 mm, incl. plug-in terminal																			<input type="checkbox"/> internal version
<b>Housing size</b>																			<b>Switching points</b>
B96 x H48 x D70 mm																			<input type="checkbox"/> no switching points
																			<input type="checkbox"/> 2 relay outputs
<b>Type of display</b>																			<b>Protection class</b>
Temperature																			<input type="checkbox"/> without keypad, operation via PM-TOOL
<b>Display colour</b>																			<input type="checkbox"/> IP65/plug-in terminal
Blue																			<b>Supply voltage</b>
Green																			<input type="checkbox"/> 230 VAC
Red																			<input type="checkbox"/> 10-30 VDC galv. isolated
Orange																			<b>Measuring input</b>
<b>Number of digits</b>																			<input type="checkbox"/> Pt100
5-digit																			<b>Analog output</b>
<b>Digit height</b>																			<input type="checkbox"/> without
14 mm																			<input type="checkbox"/> 0-10 VDC, 0/4-20 mA
<b>Digital input</b>																			<b>Temperature devices</b>
without																			<input type="checkbox"/> Pt100-3-/4-wire

Please state physical unit by order, e.g. °C

# Contents

<b>1. Brief description</b>	<b>1</b>
<b>2. Assembly</b>	<b>2</b>
<b>3. Electrical connection</b>	<b>3</b>
<b>4. Functions and operation description</b>	<b>4</b>
<b>4.1. Programming software PM-TOOL</b>	<b>5</b>
<b>5. Setting up the device</b>	<b>6</b>
<b>5.1. Switching on</b>	<b>6</b>
<b>5.2. Standard parameterisation (flat operation level)</b>	<b>6</b>
Value assignment for triggering of the signal input	
<b>5.3. Programming interlock „RUN“</b>	<b>10</b>
Activation/Deactivation of the programming interlock or change into the professional level respectively back into the flat operation level	
<b>5.4. Extended parameterisation (professional operation level)</b>	<b>11</b>
<b>5.4.1. Signal input parameter „INP“</b>	<b>11</b>
Value assignment for triggering of the signal input	
<b>5.4.2. General device parameter „FCT“</b>	<b>13</b>
Higher device functions like min/max permanent, brightness control, as well as the control of the keyboard configuration	
<b>5.4.3. Safety parameter „COD“</b>	<b>15</b>
Assignment of user and master code for locking or access to certain parameters like e.g. analog output and alarms, etc.	
<b>5.4.4. Analog output parameter „OUT“</b>	<b>17</b>
Analog output functions	
<b>5.4.5. Relay functions „REL“</b>	<b>19</b>
Parameter for the definition of the setpoints	
<b>5.4.6. Alarm parameter „AL1...AL4“</b>	<b>21</b>
Activator and dependencies of the alarms	
<b>6. Reset to factory settings</b>	<b>23</b>
Reset of the parameter to the factory default settings	
<b>7. Alarms / Relays</b>	<b>24</b>
Function principle of the switching outputs	
<b>8. Technical data</b>	<b>26</b>
<b>9. Safety advices</b>	<b>28</b>
<b>10. Error elimination</b>	<b>29</b>

## 1. Brief description

The panel meter **IM2-1C** is a 5-digit device for Pt100 sensors and a visual threshold value monitoring via the display. The configuration happens via four front keys or via the optional PC software PM-TOOL. An integrated programming interlock prevents unrequested changes of the parameters and can be unlocked again by an individual code. Optional an analog output for further processing in the equipment is available. And on demand, two free adjustable setpoints are available with which threshold values can be controlled and reported to an superior master display.

The electrical connection is carried out on the back side via plug-in terminals.

Selectable functions like e.g. the request of the min/max-value or a direct change of threshold value in operation mode complete the modern device concept.

## 2. Assembly

Please read the *Safety advices* on *page 28* before installation and keep this user manual for future reference.

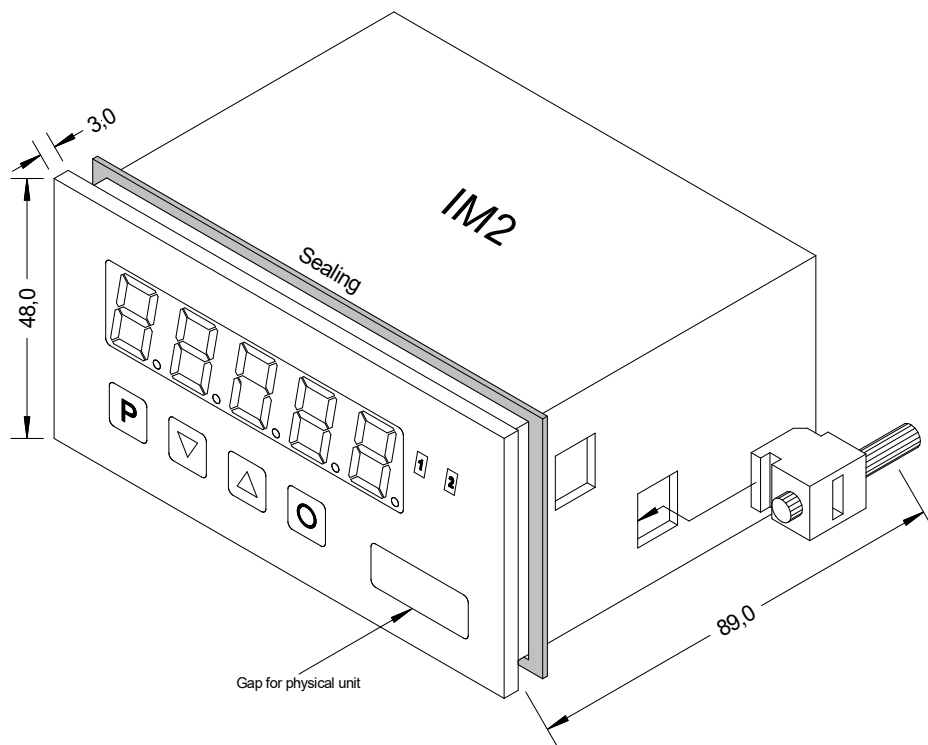

1. After removing the fixing elements, insert the device.
2. Check the seal to make sure it fits securely.
3. Click the fixing elements back into place and tighten the clamping screws by hand. Then use a screwdriver to tighten them another half a turn.

**CAUTION!** The torque should not exceed 0.1 Nm!

The dimension symbols can be exchanged before installation via a channel on the side!

### 3. Electrical connection

Type IM2-1TR5B.010C.470xD with a supply of 115 VAC

Type IM2-1TR5B.010C.570xD with a supply of 230 VAC

Type IM2-1TR5B.010C.670xD with a supply of 10-30 VDC

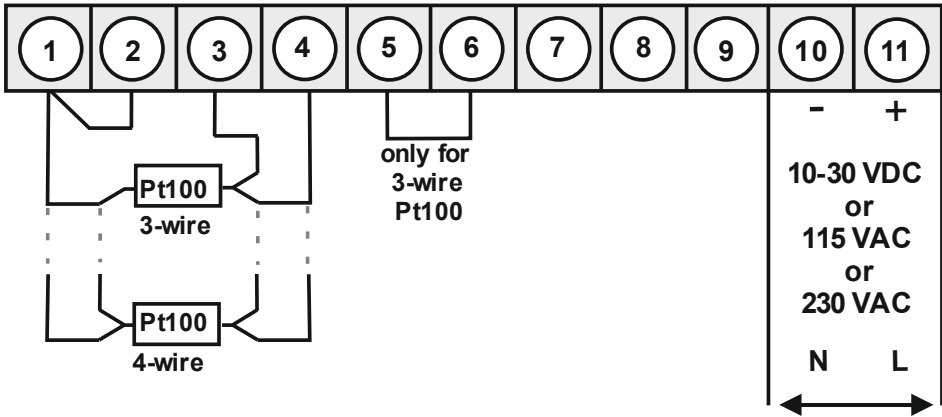

#### Options:

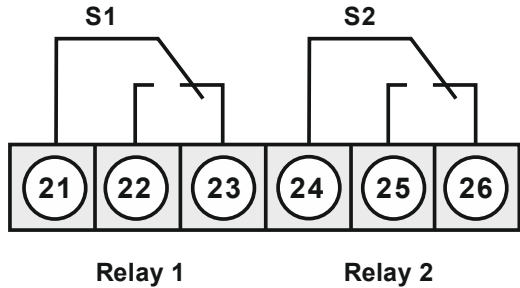
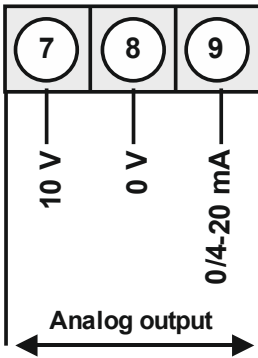

## 4. Function and operation description

### Operation

The operation is divided into three different levels.

#### Menu level (delivery status)













This level is for the standard settings of the device. Only menu items which are sufficient to set the device into operation are displayed. To get into the professional level, run through the menu level and parameterise "PROF" under menu item *RUN*.

#### Menu group level (complete function volume)

Suited for complex applications as e.g. linkage of alarms, setpoint treatment, totaliser function etc. In this level function groups which allow an extended parameterisation of the standard settings are available. To leave the menu group level, run through this level and parameterise „ULOC,, under menu item *RUN*.

#### Parameterisation level:

Parameter deposited in the menu item can here be parameterised. Functions, that can be changed or adjusted, are always signalled by a flashing of the display. Settings that are made in the parameterisation level are confirmed with **[P]** and thus saved. By pressing the **[O]**-key (zero-key) it leads to a break-off of the value input and to a change into the menu level. All adjustments are saved automatically by the device and it changes into operating mode, if no further key operation is done within the next 10 seconds.

Level	Key	Description
Menu level		Change to parameterisation level and deposited values.
	 	Keys for up and down navigation in the menu level.
		Change into operation mode.
Parameterisation level		To confirm the changes made at the parameterization level.
	 	Adjustment of the value / the setting.
		Change into menu level or break-off in value input.
Menu group level		Change to menu level.
	 	Keys for up and down navigation in the menu group level.
		Change into operation mode or back into menu level.

## Function chart:

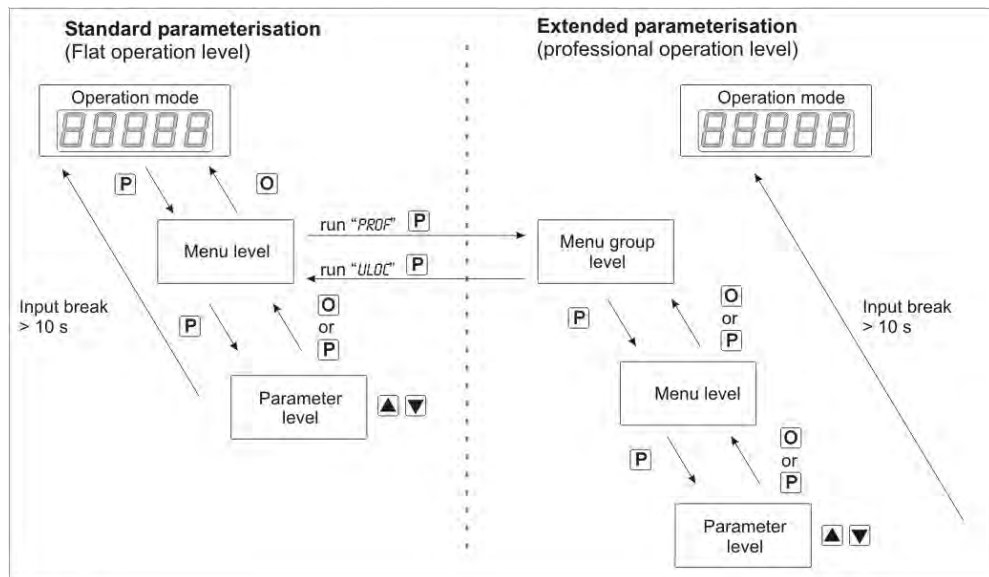

### Underline:

- P Takeover
- O Stop
- ▲ Value selection (+)
- ▼ Value selection (-)

### 4.1 Parameterisation software PM-TOOL:

Part of the PM-TOOL are the software on CD and an USB-cable with device adapter. The connection is done via a 4-pole micromatch-plug on the back side of the device, to the PC-side the connection ist done via an USB plug.

System requirements: PC incl. USB interface  
Software: Windows XP, Windows VISTA

With this tool the device configuration can be generated, omitted and saved on the PC. The parameters can be changed via the easy to handle program surface, wherent the operating mode and the possible selection options can be preset by the program.

### CAUTION!

During parameterisation with connected measuring signal, make sure that the measuring signal has no mass supply to the programming plug. The programming adapter is galvanic not isolated and directly connected with the PC. Via polarity of the input signal, a current can discharge via the adapter and destroy the device as well as other connected components!



## 5. Setting up the device

### 5.1. Switching-on





Once the installation is complete, you can start the device by applying the voltage supply. First, check once again that all electrical connections are correct.

#### Starting sequence

For 1 second during the switching-on process, the segment test (*B B B B B*) is displayed followed by an indication of the software type and, after that, also for 1 second the software version. After the starting sequence, the device switches to operation/display mode.

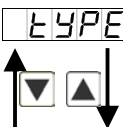
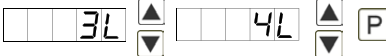
### 5.2. Standard parameterisation: (Flat operation level)

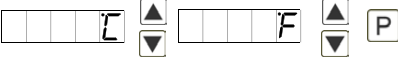
To parameterise the display, press the **[P]** key in operating mode for 1 second. The display then changes to the menu level with the first menu item *TYPE*.

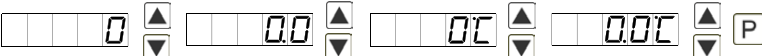
Menu level	Parameterisation level
	<p><b>Selection of the input signal, <i>TYPE</i>:</b> Default: 4L</p>  <p>Selectable as measuring input types are 3-wire and 4-wire Pt100 signals. Confirm the selection with <b>[P]</b> and the display switches back to menu level.</p>
	<p><b>Type of temperature measurement, <i>UNIT</i>:</b> Default: °C</p>  <p>Select between °C and °F to display the temperature. Confirm the selection with <b>[P]</b> and the display switches back to menu level.</p>
	<p><b>Setting the decimal point / physical unit, <i>DOT</i>:</b> Default: 0.0</p>  <p>The decimal point and the physical unit of the device can be adjusted with <b>[▼]</b> <b>[▲]</b>. If e.g. temperature measurement is selected in °C, select 0°C respectively 0.0°C in the parameterisation level. Confirm the selection with <b>[P]</b> and the display switches back to menu level.</p>

## Menu level

## Parameterisation level

**Impedance matching, *OFFS*:**

Default: 0.0

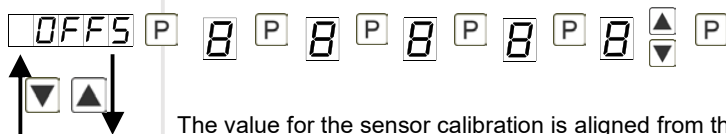

The value for the sensor calibration is aligned from the smallest to the highest digit [▼] [▲] and confirmed digit per digit with [P]. After the last digit, the device changes back into menu level. During a temperature measurement in °C the value calibration can be adjusted between -20.0 and +20.0 and can be set during a measurement in °F between -36.0 and +36.0. If the measurement is switched later on, the value is rounded.

**Setting up the display time, *SEC*:**

Default: 1.0

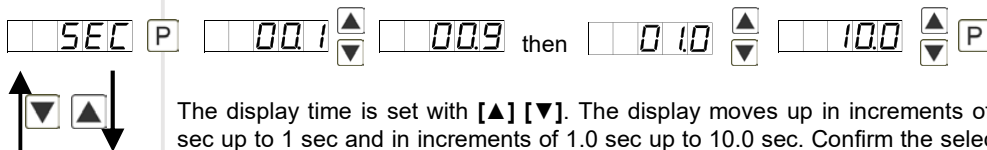

The display time is set with [▲] [▼]. The display moves up in increments of 0.1 sec up to 1 sec and in increments of 1.0 sec up to 10.0 sec. Confirm the selection by pressing the [P] button. The display then switches back to the menu level again.

**Selection of analog output, *OUT.RA*:**

Default: 4-20

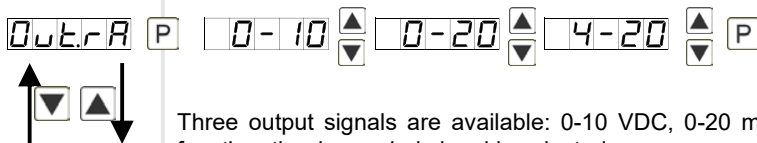

Three output signals are available: 0-10 VDC, 0-20 mA and 4-20 mA, with this function, the demanded signal is selected.

**Setting up the final value of the analog output, *OUT.EN*:**

Default: 850.0

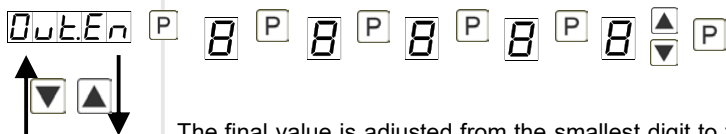

The final value is adjusted from the smallest digit to the highest digit with [▲] [▼] and digit by digit confirmed with [P]. A minus sign can only be parameterised on the highest digit. After the last digit, the device changes back into menu level.

## Menu level

## Parameterisation level

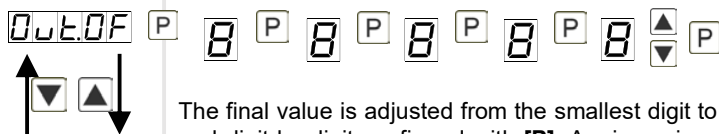
**Setting up the initial value of the analog output, *OUT.OF*:**Default: *-200.0*

The final value is adjusted from the smallest digit to the highest digit with **[▲]** **[▼]** and digit by digit confirmed with **[P]**. A minus sign can only be parameterised on the highest digit. After the last digit, the device changes back into menu level.

**Threshold values / limit values, *LI-1*:**Default: *200.0*

This limit value defines the threshold, that leads to an activation / deactivation of the alarm.

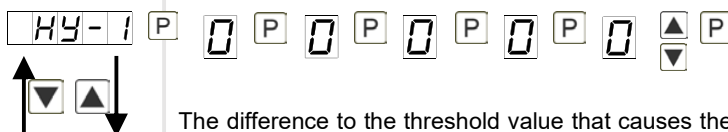
**Hysteresis for limit values, *HY-1*:**Default: *0.0*

The difference to the threshold value that causes the delay of the actuation of the alarm, is defined by the hysteresis.

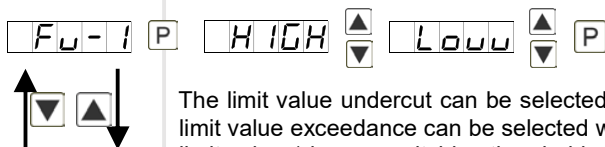
**Function if display falls below / exceeds limit value, *FU-1*:**Default: *HIGH*

The limit value undercut can be selected with *LOW* (LOW = lower limit value) and limit value exceedance can be selected with *HIGH* (HIGH = upper limit value). If e.g. limit value 1 is on a switching threshold of 100 and occupied with function *HIGH*, the alarm will be activated by reaching the threshold. If the limit value is allocated to *LOW*, an alarm will be activated by undercut of the threshold.

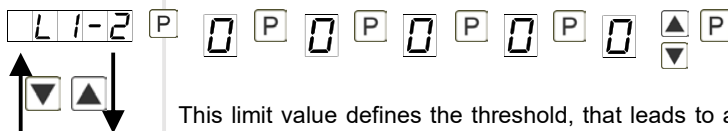
**Threshold values / limit values, *LI-2*:**Default: *300.0*

This limit value defines the threshold, that leads to an activation / deactivation of the alarm.

## Menu level

## Parameterisation level

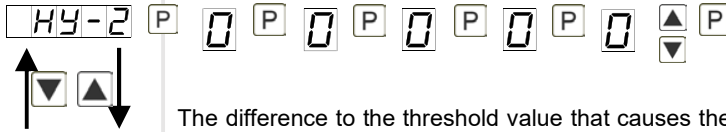
**Hysteresis for threshold values, *HY-2*:**Default: *0.0*

The difference to the threshold value that causes the delay of the actuation of the alarm, is defined by the hysteresis.

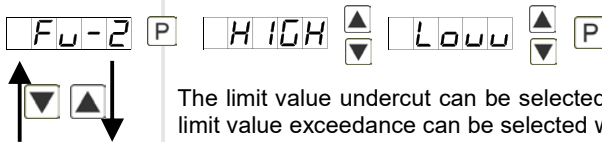
**Function if display falls below / exceeds limit value, *FU-2*:**Default: *HIGH*

The limit value undercut can be selected with *LOW* (LOW = lower limit value) and limit value exceedance can be selected with *HIGH* (HIGH = upper limit value). If e.g. limit value 1 is on a switching threshold of 100 and occupied with function *HIGH*, the alarm will be activated by reaching the threshold. If the limit value is allocated to *LOW*, an alarm will be activated by undercut of the threshold.

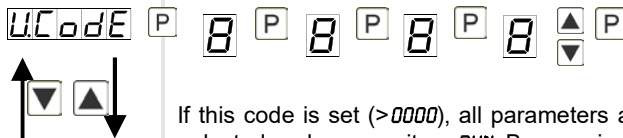
**User code (4-digit number-combination, free available), *U.CODE*:**Default: *0000*

If this code is set (>0000), all parameters are locked for the user, if *LOC* has been selected under menu item *RUN*. By pressing [**P**] for approx. 3 seconds in operation mode, the message *CODE* is shown in the display. Enter the preset *U.CODE* to get access to the for the user unlocked set of parameters. The code needs to be entered bevor each try of parameterisation, as long as *A.CODE* (Master code) all parameters are unlocked again.

## Menu level

## Parameterisation level

**Master code (4-digit number-combination free available), *A.CODE*:**

Default: 1234

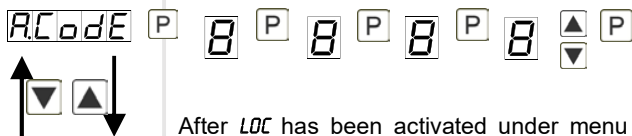

After *LOC* has been activated under menu item *RUN*, this code can be used for unlocking all parameters. By pressing **[P]** for approx. 3 seconds in operation mode, the message *CODE* is shown in the display and offer the user access to all parameters by entering *A.CODE*. While leaving this parameterisation it can be unlocked permanently under *RUN* by selecting *ULOC* or *PROF*. So, at an anew pressing of **[P]** in operating mode, an anew entering of the code is not needed.

### 5.3. Programming interlock

**Activation / Deactivation of the programming interlock or completion of the standard parameterisation with change into menu group level (complete function volume), *RUN*:**

Default: *ULOC*

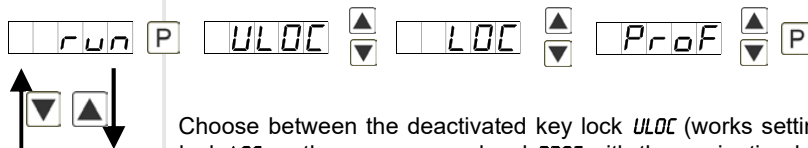

Choose between the deactivated key lock *ULOC* (works setting), the activated key lock *LOC*, or the menu group level *PROF* with the navigation keys **[▲]** **[▼]**. Confirm the selection with **[P]**. After this, the display confirms the settings with "- - - -" and automatically switches into operating mode. If *LOC* was selected, the keyboard is locked. To get back into the menu level, press **[P]** for 3 seconds in operating mode. Now enter the *CODE* (works setting 1234) that appears using **[▲]** **[▼]** plus **[P]** to unlock the keyboard. *FAIL* appears if the input is wrong.

To parameterise further functions, *PROF* needs to be set. The device confirms this setting with „- - - -“, and changes automatically into operation mode. By pressing **[P]** for approx. 3 seconds in operation mode, the first menu group *IMP* is shown in the display and thus confirms the change into the extended parameterisation. It stays as long activated as *ULOC* is entered in menu group *RUN*, thus the display is set back in standard parameterisation again.

## 5.4. Extended parameterisation (Professional operation level)

### 5.4.1. Signal input parameters

#### Menu group level

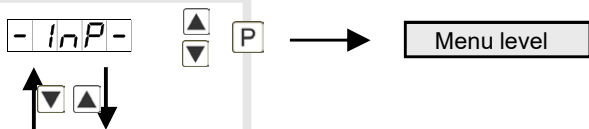

#### Menu level

#### Parameterisation level

##### Selection of the input signal, *TYPE*:

Default: 4L

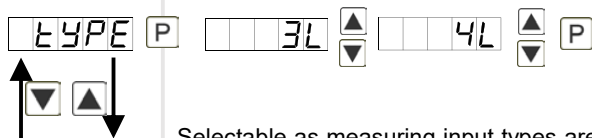

Selectable as measuring input types are 3-wire and 4-wire-Pt100 signals. Confirm the selection with [P] and the display switches back to menu level.

##### Type of temperature measurement, *UNIT*:

Default: °C

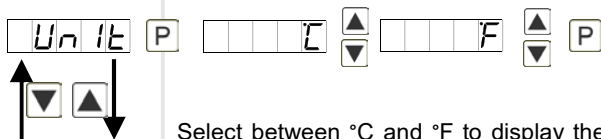

Select between °C and °F to display the temperature. Confirm the selection with [P] and the display switches back to menu level.

##### Setting the decimal point / physical unit, *DOT*:

Default: 0.0

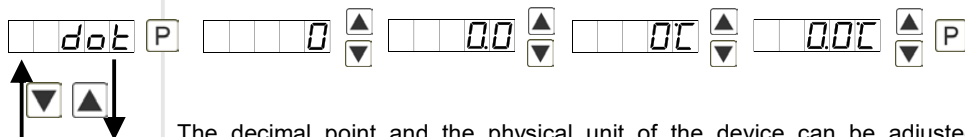

The decimal point and the physical unit of the device can be adjusted with [▼] [▲]. If e.g. temperature measurement is selected in °C, select 0°C respectively 0.0°C in the parameterisation level. Confirm the selection with [P] and the display switches back to menu level.

## Menu level

## Parameterisation level

**Impedance matching, *OFFS*:**

Default: 0.0

 OFFS [P] [8] [P] [8] [P] [8] [P] [8] [P] [8] [▲] [P]

The value for the sensor calibration is aligned from the smallest to the highest digit [▼] [▲] and confirmed digit per digit with [P]. After the last digit, the device changes back into menu level. During a temperature measurement in °C the value calibration can be adjusted between -20.0 and +20.0 and can be set during a measurement in °F between -36.0 and +36.0. If the measurement is switched later on, the value is rounded.

**Setting up the display time, *SEC*:**

Default: 1.0

 SEC [P] [0] [0] [▲] [0] [0] [▼] then [0] [1] [0] [▲] [1] [0] [▼] [P]

The display time is set with [▲] [▼]. The display moves up in increments of 0.1 sec up to 1 sec and in increments of 1.0 sec up to 10.0 sec. Confirm the selection by pressing the [P] button. The display then switches back to the menu level again.

**Device undercut, *DI.UND*:**

Default: -19999

 di.Und [P] [8] [P] [8] [P] [8] [P] [8] [P] [8] [▲] [P]

With this function the device undercut (\_\_\_\_) can be defined on a definite value. Exception is input type **4-20 mA**, it already shows undercut at a signal <1 mA, so a sensor failure is marked.

**Display overflow, *DI.QUE*:**

Default: 99999

 di.QUE [P] [8] [P] [8] [P] [8] [P] [8] [P] [8] [▲] [P]

With this function the display overflow (----) can be defined on a definite value.

 rEt
**Back to menu group level, *RET*:**

With [P] the selection is confirmed and the device changes into menu group level „-IMP-“.

## 5.4.2. General device parameters

## Menu group level

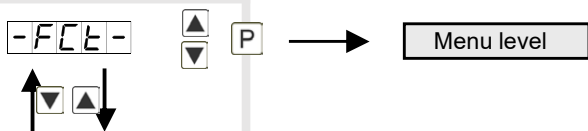

## Menu level

## Parameterisation level

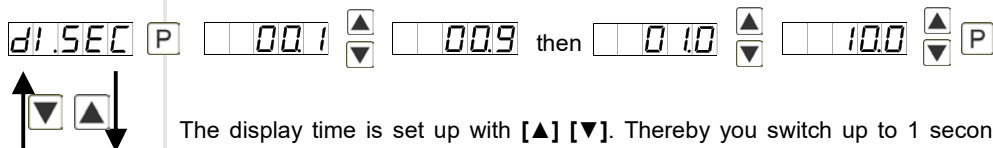
**Display time, *DISC*:**Default: *01.0*

The display time is set up with [**▲**] [**▼**]. Thereby you switch up to 1 second in increments of 0.1 and up to 10.0 seconds in increments of 1.0. With [**P**] the selection is confirmed and the device changes into menu level.

**Rounding of display values, *ROUND*:**Default: *00001*

This function is for instable display values, where the display value is changed in steps of 1, 5, 10 or 50. This does not affect the resolution of the optional outputs. With [**P**] the selection is confirmed and the device changes into menu level.

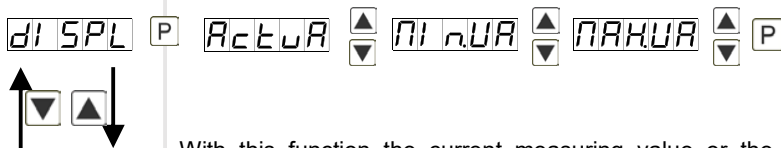
**Display, *DISPL*:**Default: *ACTUA*

With this function the current measuring value or the min/max value can be allocated to the display. With [**P**] the selection is confirmed and the device changes into menu level.



## Menu level

## Parameterisation level

**Brightness control, LIGHT:**

Default: 15

 LIGHT P    00    ▲    15    ▲    P  
                  ▼                   ▼

The brightness of the display can be adjusted in 16 levels from 00 = very dark to 15 = very bright via this parameter or alternatively via the navigation keys from the outside. During the start of the device the level that is deposited under this parameter will always be used, even though the brightness has been changed via the navigation keys in the meantime.

**Display flashing, FLASH:**

Default: NO

 FLASH P    no    ▲    AL-1    ▲    AL-2    ▲    AL.12    ▲  
                  ▼                   ▼                   ▼                   ▼  
                  ▲    AL-3    ▲    AL-4    ▲    AL.34    ▲    AL.AL    ▲    P  
                  ▼                   ▼                   ▼                   ▼



A display flashing can be added as additional alarm function either to single or to a combination of off-limit condition. With *NO*, no flashing is allocated.

**Assignment (deposit) of key functions, TAST:**

Default: NO

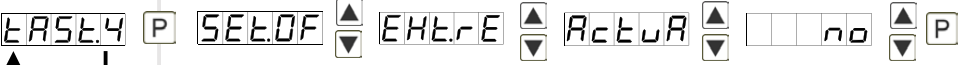

 TASTE P    EHTR    ▲    LI.12    ▲    LI.34    ▲    LIGHT    ▲  
                  ▼                   ▼                   ▼                   ▼  
                  ▲    no    ▲    P  
                  ▼

For the operation mode, special functions can be deposited on the navigation keys [▲] [▼], in particular this function is made for devices in housing size 48x24mm which do not have a 4th key ([O]-key). If the min/max-memory is activated with *EHTR*, all measured min/max-values are saved during operation and can be recalled via the navigation keys. The values get lost by re-start of the device. If the threshold value correction *LI.12* or *LI.34* is chosen, the values of the threshold can be changed during operation without disturbing the operating procedure. Under *LIGHT* the brightness can be changed during operation. If *NO* is selected, the navigation keys are without any function in the operation mode.

Menu level	Parameterisation level
	<p><b>Special function [O]-key, TRST.4:</b> Default: <i>NO</i></p> <p>  </p> <p>For the operation mode, special functions can be deposited on the [O]-key. This function is activated by pressing the key. <i>SELOF</i> adds a defined value to the currently displayed value. <i>EHT.RE</i> deletes the min/max-memory. <i>ACTUA</i> shows the measuring value for approx. 7 seconds, after this the device switches back onto the parameterised display value. If <i>NO</i> is selected, the [O]-key is without any function in the operation mode.</p>
	<p><b>Back to menu group level, RET:</b></p> <p>With [P] the selection is confirmed and the device changes into menu group level „-FCT-“.</p>

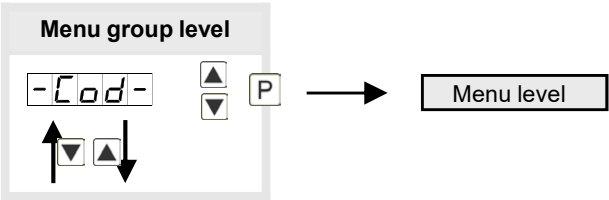
5.4.3. Safety parameters



Menu level	Parameterisation level
	<p><b>Adjustment of user code, U.CODE:</b> Default: <i>0000</i></p> <p>  </p> <p>Via this code reduced sets of parameters <i>OUT.LE</i> and <i>AL.LEV</i> can be unlocked during locked programming. Further parameters are not available via this code. The <i>U.CODE</i> can only be changed via the correct input of the <i>R.CODE</i> (Master code).</p>

## Menu level

## Parameterisation level

**Master code, *R.CODE*:**

Default: 1234

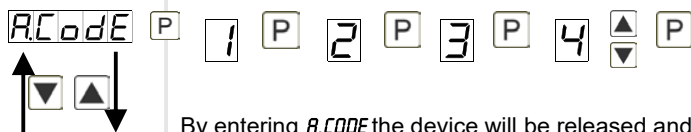

By entering *R.CODE* the device will be released and all parameters unlocked.

**Release/ lock analog output parameters, *OUT.LE*:**

Default: ALL

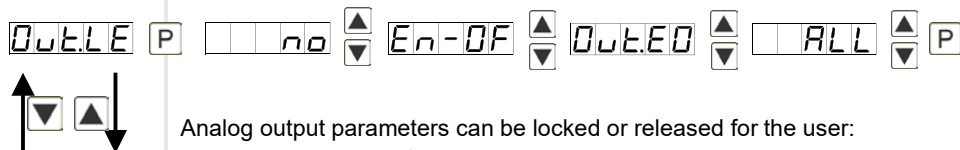

Analog output parameters can be locked or released for the user:

- At *EN-OF* the initial or final value can be changed in operation mode.
- At *OUT.ED* the output signal can be changed from e.g. 0-20 mA to 4-20 mA or 0-10 VDC.
- At *ALL* analog output parameters are released.
- At *NO* all analog output parameters are locked.

**Release/lock alarm parameters, *AL.LEU*:**

Default: ALL

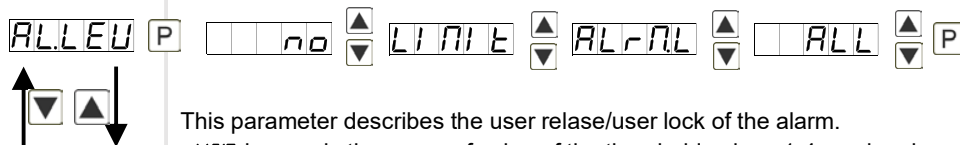

This parameter describes the user release/user lock of the alarm.

- *LIMIT*, here only the range of value of the threshold values 1-4 can be changed.
- *ALRM.L*, here the range of value and the alarm trigger can be changed.
- *ALL*, all alarm parameters are released.
- *NO*, all alarm parameters are locked.

RET

**Back to menu group level, *RET*:**

With [P] the selection is confirmed and the device changes into menu group level „-COD-“.

## 5.4.4. Analog output parameters

## Menu group level

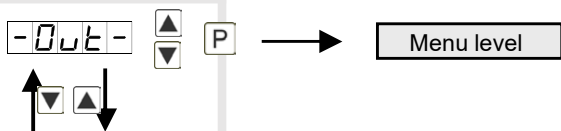

## Menu level

## Parameterisation level

Selection reference analog output, *OUTPT*:Default: *ACTUA*

The analog output signal can refer to different functions, in detail this are the current measurand, min-value or max-value. With **[P]** the selection is confirmed and the device changes into menu level.

Selection analog output, *OUT.RA*:Default: *4-20*

Three output signals are available: 0-10 VDC, 0-20 mA and 4-20 mA. With this function the demanded signal can be selected.

Setting up the final value of the analog output, *OUT.EN*:Default: *850.0*

The final value can be adjusted from the smallest to the largest digit with **[▲]** **[▼]**. Confirm each digit with **[P]**. A minus sign can only be parameterized on the highest value digit. After the last digit, the display switches back to the menu level.

Setting up the initial value of the analog output, *OUT.OF*:Default: *-200.0*

The initial value can be adjusted from the smallest to the largest digit with **[▲]** **[▼]**. Confirm each digit with **[P]**. A minus sign can only be parameterized on the highest value digit. After the last digit, the display switches back to the menu level.

## Menu level

## Parameterisation level

**Overflow behavior, *O.FLOU*:**Default: *EDGE*



To recognise and evaluate faulty signals, e.g. by a controller, the overflow behavior of the analog output can be defined. As overflow can be seen either *EDGE*, that means the analog output runs on the set limits e.g. 4 mA and 20 mA, or *TO.OFF* (input value smaller than initial value, analog output changes on e.g. 4 mA), *TO.END* (higher than final value, analog output changes on e.g. 20 mA). If *TO.MIN* or *TO.MAX* is set, the analog output changes on the smallest or highest possible binary value. This means that values of e.g. 0 mA, 0 VDC or values higher than 20 mA or 10 VDC can be reached. With **[P]** the selection is confirmed and the device changes into menu level.



**Back to menu group level, *RET*:**

With **[P]** the selection is confirmed and the device changes into menu group level *..-OUT-*.

## 5.4.5. Relay functions

## Menu group level

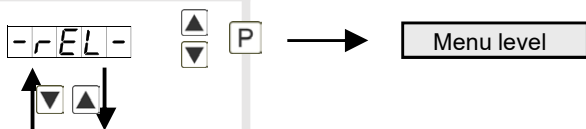

## Menu level

## Parameterisation level

## Alerting relay 1, REL-1:

Default: AL-1

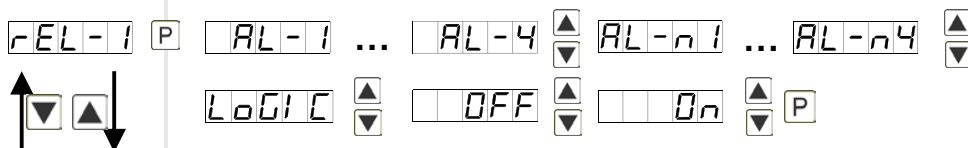

Each setpoint (optional) can be linked up via 4 alarms (by default). This can either be inserted at activated alarms *AL1/4* or deactivated alarms *ALM1/4*. If *LOGIC* is selected, logical links are available in the menu level *LOG-1* and *COM-1*. Access to these two menu levels via *LOGIC*, at all other selected functions, these two parameters are overlapped. Via *ON/OFF* the setpoints can be activated/deactivated, in this case the output and the setpoint display are set/not set on the front of the device. With **[P]** the selection is confirmed and the device changes into menu level.

## Logic relay 1, LOG-1

Default: OR

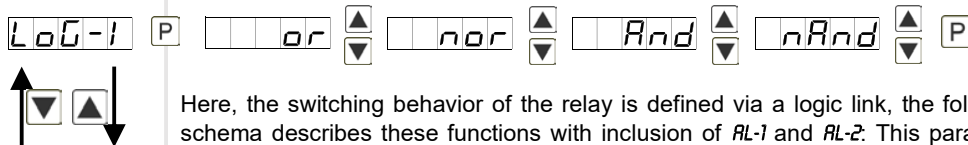

Here, the switching behavior of the relay is defined via a logic link, the following schema describes these functions with inclusion of *AL-1* and *AL-2*. This parameter can only be selected if *LOGIC* was selected under *REL-1*.

<input type="checkbox"/> <input type="checkbox"/> <input type="checkbox"/> or	$A1 \vee A2$	As soon as a selected alarm is activated, the relay operates. Equates to operating current principle.
<input type="checkbox"/> <input type="checkbox"/> nor	$\overline{A1 \vee A2} = \overline{A1} \wedge \overline{A2}$	The relay operates only, if no selected alarm is active. Equates to quiescent current principle.
<input type="checkbox"/> <input type="checkbox"/> And	$A1 \wedge a2$	The relay operates only, if all selected alarms are active.
<input type="checkbox"/> <input type="checkbox"/> nAnd	$\overline{A1 \wedge A2} = \overline{A1} \vee \overline{A2}$	As soon as a selected alarm is not activated, the relay operates.

With **[P]** the selection is confirmed and the device changes into menu level.

## Menu level

## Parameterisation level

**Alarms for relay 1, COM-1:**Default: *AL-1*

COM-1 [P] AL-1 [▲] [▼] AL-2 [▲] [▼] ... AL-1234 [▲] [▼] [P]



The allocation of the alarms to relay 1 happens via this parameter, one alarm or a group of alarms can be chosen. This parameter can only be selected if *LOGIC* was selected under *REL-1*. With [P] the selection is confirmed and the device changes into menu level.

**Alerting relay 2, REL-2:**Default: *AL-2*

REL-2 [P] AL-5 ... AL-8 [▲] [▼] AL-n5 ... AL-n8 [▲] [▼]  
 LOGIC [▲] [▼] OFF [▲] [▼] ON [▲] [▼] [P]



Each setpoint (optional) can be linked up via 4 alarms (by default). This can either be inserted at activated *AL1/4* or deactivated alarms *ALM1/4*. If *LOGIC* is selected, logical links are available in the menu level *LOG-1* and *COM-1*. Access to these two menu levels is only via *LOGIC*, at all other selected functions, these two parameters are overlapped. Via *ON/OFF* the setpoints can be activated/deactivated, in this case the output and the setpoint display are set/not set on the front of the device. With [P] the selection is confirmed and the device changes into menu level.

**Logic relay 2, LOG-2:**Default: *OR*



LOG-2 [P] or [▲] [▼] nor [▲] [▼] And [▲] [▼] nAnd [▲] [▼] [P]



Here, the switching behavior of the relay is defined via a logic link, the following schema describes these functions with inclusion of *AL-1* and *AL-2*. This parameter can only be selected if *LOGIC* was selected under *REL-2*.

or	$A1 \vee A2$	As soon as a selected alarm is activated, the relay operates. Equates to operating current principle.
nor	$\overline{A1 \vee A2} = \overline{A1} \wedge \overline{A2}$	The relay operates only, if no selected alarm is active. Equates to quiescent current principle.
And	$A1 \wedge a2$	The relay operates only, if all selected alarms are active.
nAnd	$\overline{A1 \wedge A2} = \overline{A1} \vee \overline{A2}$	As soon as a selected alarm is not activated, the relay operates.

With [P] the selection is confirmed and the device changes into menu level.





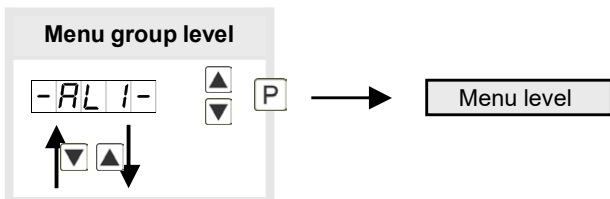

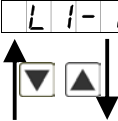

Menu level	Parameterisation level
	<p><b>Alarms for relay 2, COM-2:</b> Default: <i>A.2</i></p> <p>COM-2 [P] A.1 [▲] [▼] A.2 [▲] [▼] ... A.1234 [▲] [▼] [P]</p> <p>The allocation of the alarms to relay 1 happens via this parameter, one alarm or a group of alarms can be chosen. This parameter can only be selected if <i>LOGIC</i> was selected under <i>REL-1</i>. With [P] the selection is confirmed and the device changes into menu level.</p>
	<p><b>Back to menu group level, RET:</b></p> <p>With [P] the selection is confirmed and the device changes into menu group level „-REL-“.</p>

### 5.4.6. Alarm parameters

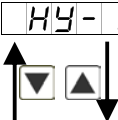

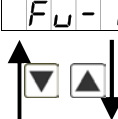
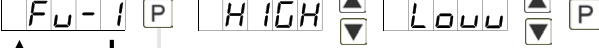
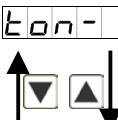
Menu level	Parameterisation level
	<p><b>Dependency of alarm 1, ALRM.1:</b> Default: <i>ACTUA</i></p> <p>ALRM.1 [P] ACTUA [▲] [▼] MINUA [▲] [▼] MAXUA [▲] [▼] [P]</p> <p>The dependency of alarm 1 can be related to special functions, in detail these are the current measurand, the min-value or the max-value. <i>EHTER</i> causes the dependency either by pressing the [O]-key on the front of the housing or by an external signal via the digital input. With [P] the selection is confirmed and the device changes into menu level.</p> <p><b>Example:</b> By using the maximum value <i>ALARM.1 = MAX.VA</i> in combination with a threshold monitoring <i>FU-1 = HIGH</i>, an alarm confirmation can be realised. Use the navigation keys or the fourth key for confirmation.</p>

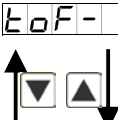

Menu level	Parameterisation level
	<p><b>Threshold values / limits, LI-1:</b> Default: 200.0</p> <p>  </p> <p>This limit value defines the threshold, that leads to an activation / deactivation of the alarm.</p>
	<p><b>Hysteresis for threshold values, HY-1:</b> Default: 0.0</p> <p>  </p> <p>The difference to the threshold value that causes the delay of the actuation of the alarm, is defined by the hysteresis.</p>
	<p><b>Function for threshold value exceedance / undercut, FU-1:</b> Default: HIGH</p> <p>  </p> <p>The limit value undercut can be selected with <i>LOW</i> (LOW = lower limit value) and limit value exceedance can be selected with <i>HIGH</i> (HIGH = upper limit value). If e.g. limit value 1 is on a switching threshold of 100 and occupied with function <i>HIGH</i>, the alarm will be activated by reaching the threshold. If the limit value is allocated to <i>LOW</i>, an alarm will be activated by undercut of the threshold.</p>
	<p><b>Switching-on delay, TOM-1:</b> Default: 000</p> <p>  </p> <p>For limit value 1 one can preset a delayed switching-on of 0-100 seconds.</p>
	<p><b>Switching-off delay, TOF-1:</b> Default: 000</p> <p>  </p> <p>For limit value 1 one can preset a delayed switching-off of 0-100 seconds.</p>

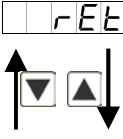
Menu level	Parameterisation level
	<p><b>Back to menu group level, <i>RET</i>:</b></p> <p>With [<b>P</b>] the selection is confirmed and the device changes into menu group level „-AL1-“.</p>

**The same applies to -AL2- to -AL4-.**

### Programming interlock:

Menu-group level	
	<p>Description see page 10, menu-level <i>RUN</i></p>

## 6. Reset to factory settings

To return the unit to a **defined basic state**, a reset can be carried out to the default values.

The following procedure should be used:

- Switch off the power supply
- Press button [**P**]
- Switch on voltage supply and press [**P**]-button until „- - - -“ is shown in the display.

With reset, the default values of the program table are loaded and used for subsequent operation. This sets the unit back to the state in which it was supplied.

**Caution! All application-related data are lost.**

## 7. Alarms / Relays

This device has 4 virtual alarms that can monitor one limit value in regard of an undercut or exceedance. Each alarm can be allocated to an optional relay output S1-S2; furthermore alarms can be controlled by events like e.g. min/max-value.

### Function principle of alarms / relays

<b>Alarm / Relay x</b>	Deactivated, instantaneous value, min/max-value or an activation via the [O]-key.
<b>Switching threshold</b>	Threshold / limit value of the change-over.
<b>Hysteresis</b>	Broadness of the window between the switching thresholds.
<b>Working principle</b>	Operating strom / Quiescent current

### Operating current

By operating current the alarm S1-S2 is **off** below the threshold and **on** on reaching the threshold.

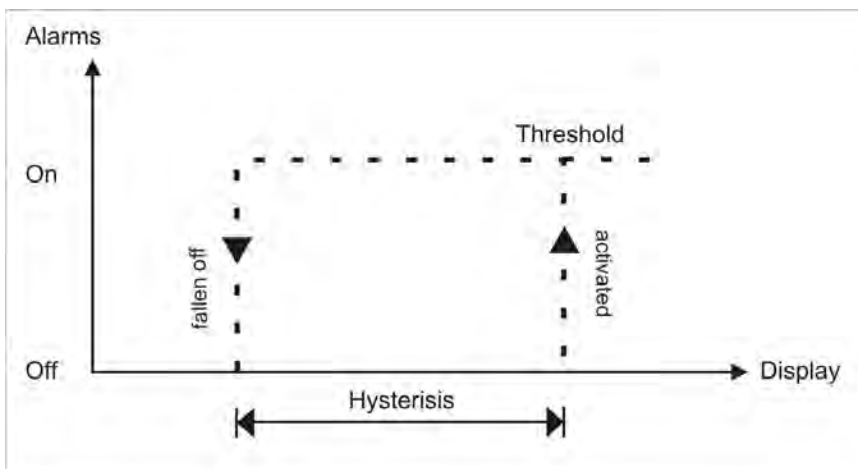

### Quiescent current

By quiescent current the alarm S1-S2 is **on** below the threshold and switched **off** on reaching the threshold.

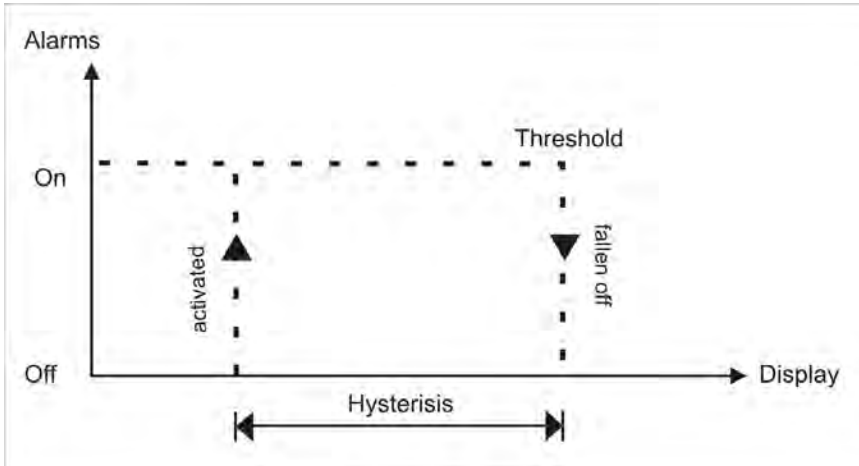

### Switching-on delay

The switching-on delay is activated via an alarm and e.g. switched 10 seconds after reaching the switching threshold, a short-term exceedance of the switching value does not cause an alarm, respectively does not cause a switching operation of the relay. The switching-off delay operates in the same way, keeps the alarm / the relay switched longer for the parameterised time.

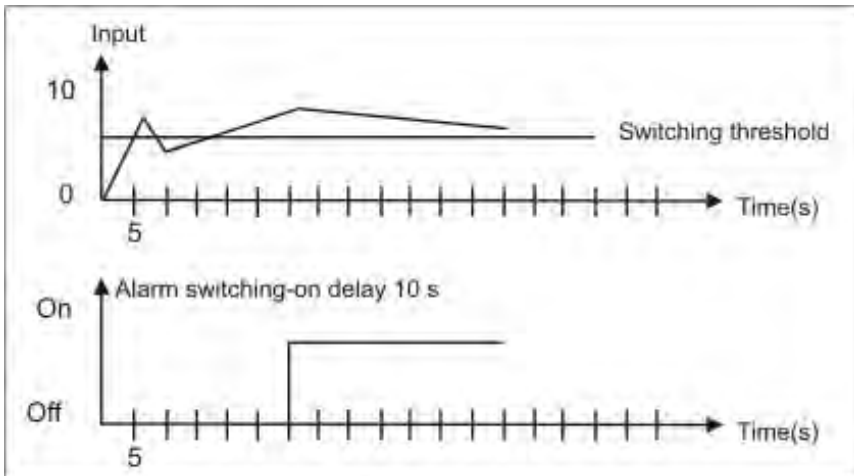

## 8. Technical data

<b>Housing</b>			
<b>Dimensions</b>	96x48x70 mm (BxHxD)		
	96x48x89 mm (BxHxD) including plug-in terminal		
Panel cut-out	92.0 <sup>+0.8</sup> x 45.0 <sup>+0.6</sup> mm		
Wall thickness	up to 15 mm		
Fixing	screw elements		
Material	PC Polycarbonate, black, UL94V-0		
Sealing material	EPDM, 65 Shore, black		
Protection class	standard IP65 (Front), IP00 (Back side)		
Weight	approx. 200 g		
Connection	plug-in terminal; wire cross-section up to 2.5 mm <sup>2</sup>		
<b>Display</b>			
Digit height	14 mm		
Segment colour	red (optional green, orange or blue)		
Display range	-19999 up to 99999		
Setpoints	one LED per setpoint		
Overflow	horizontal bars at the top		
Underflow	horizontal bars at the top		
Display time	0.1 to 10.0 seconds		
<b>Input</b>	<b>Measuring range</b>	<b>Measuring error</b>	<b>Digit</b>
Pt100 2-Leiter	-200.0...850.0°C	0.1 % of measuring range	±1
Pt100 2-Leiter	-328.0...1562.0°C	0.1 % of measuring range	±1
<b>Accuracy</b>			
Temperature drift	100 ppm / K		
Measuring time	0.1...10.0 seconds		
Measuring principle	U/F-conversion		
Resolution	0.1°C or 0.1°F		

<b>Output</b>	
Analog output	0/4-20 mA / burden 350 Ohm; 0-10 VDC / burden 10 kOhm, 16 bit
Switching outputs	
Relay with change-over contacts	250 VAC / 5 AAC; 30 VDC / 5 ADC 30 x 10 <sup>3</sup> at 5 AAC, 5 ADC ohm resistive burden
Switching cycles	10 x 10 <sup>6</sup> mechanically Diversification according to DIN EN50178 / Characteristics according to DIN EN60255
<b>Power supply</b>	230 VAC ± 10 % max. 10 VA 10-30 VDC galv. isolated, max. 4 VA
<b>Memory</b>	
	EEPROM
Data life	≥ 100 years at 25°C
<b>Ambient conditions</b>	
Working temperature	0...50°C
Storing temperature	-20...80°C
Weathering resistance	relative humidity 0-80% on years average without dew
<b>EMV</b>	
	EN 61326
<b>CE-sign</b>	
	Conformity according to directive 2014/30/EU
<b>Safety standard</b>	
	According to low voltage directive 2014/35/EU EN 61010; EN 60664-1

## 9. Safety advices

Please read the following safety advices and the assembly *chapter 2* before installation and keep it for future reference.

### Proper use

The **IM2-1C-device** is designed for the evaluation and display of sensor signals.



**Attention! Careless use or improper operation can result in personal injury and/or damage to the equipment.**

### Control of the device

The panel meters are checked before dispatch and sent out in perfect condition. Should there be any visible damage, we recommend close examination of the packaging. Please inform the supplier immediately of any damage.



### Installation

The **IM2-1C-device** must be installed by a suitably **qualified specialist** (e.g. with a qualification in industrial electronics).

### Notes on installation

- There must be no magnetic or electric fields in the vicinity of the device, e.g. due to transformers, mobile phones or electrostatic discharge.
- The fuse rating of the supply voltage should not exceed a value of **0.5 A N.B. fuse!**
- Do not install **inductive consumers** (relays, solenoid valves etc.) near the device and **suppress** any interference with the aid of RC spark extinguishing combinations or free-wheeling diodes.
- Keep input, output and supply lines separate from one another and do not lay them parallel with each other. Position “go” and “return lines” next to one another. Where possible use twisted pair. This way, the best measuring results can be received.
- Screen off and twist sensor lines. Do not lay current-carrying lines in the vicinity. Connect the **screening on one side** on a suitable potential equaliser (normally signal ground).
- The device is not suitable for installation in areas where there is a risk of explosion.
- Any electrical connection deviating from the connection diagram can endanger human life and/or can destroy the equipment.
- The terminal area of the devices is part of the service. Here electrostatic discharge needs to be avoided. Attention! High voltages can cause dangerous body currents.
- Galvanic isolated potentials within one complex need to be placed on an appropriate point (normally earth or machines ground). So, a lower disturbance sensibility against impacted energy can be reached and dangerous potentials, that can occur on long lines or due to faulty wiring, can be avoided.

## 10. Error elimination

	Error description	Measures
1.	<p>The unit permanently indicates overflow.</p> 	<ul style="list-style-type: none"> <li>The input has a very high measurement, check the measuring circuit.</li> <li>The input is open.</li> </ul>
2.	<p>The unit permanently shows underflow.</p> 	<ul style="list-style-type: none"> <li>The input has a very low measurement, check the measuring circuit .</li> <li>The input is open.</li> </ul>
3.	<p>The word <b>HELP</b> lights up in the 7-segment display.</p>	<ul style="list-style-type: none"> <li>The unit has found an error in the configuration memory. Perform a reset on the default values and reconfigure the unit according to your application.</li> </ul>
4.	<p>Program numbers for parameterising of the input are not accessible.</p>	<ul style="list-style-type: none"> <li>Programming lock is activated.</li> <li>Enter correct code.</li> </ul>
5.	<p><b>Err1</b> lights up in the 7-segment display.</p>	<ul style="list-style-type: none"> <li>Please contact the manufacturer if errors of this kind occur.</li> </ul>
6.	<p>The device does not react as expected.</p>	<ul style="list-style-type: none"> <li>If you are not sure that the device has been parameterised before, then follow the steps as written in <i>chapter 6</i> and set it back to its delivery status.</li> </ul>