

User manual IM2

Direct voltage signals: Shunt 0-60/150/300/1000 mV



Technical features:

- red display of -19999...99999 Digits (optional: green, orange or blue display)
- minimal installation depth: 70 mm without plug-in screw terminal
- min/max-memory
- 30 additional adjustable supporting points
- display flashing at threshold value exceedance / threshold value undercut
- zero-key for triggering of Hold, Tara
- permanent min/max-value recording
- volume metering (Totaliser)
- mathematic functions like reciprocal value, square root, squaring or rounding
- setpoint generator
- sliding average determination
- brightness control
- programming interlock via access code
- protection class IP65 at the front side
- plug-in screw terminal
- optional: 2 relay outputs
- optional: analog output or galvanic isolated digital input
- accessories: PC-based configuration-kit PM-TOOL with CD & USB-adapter for devices without keypad and for a simple adjustment of standard devices

Identification

STANDARD-TYPES	ORDER NUMBER
Direct current shunt	IM2-1VR5B.0002.570xD
Housing size: 96x48 mm	IM2-1VR5B.0002.670xD

Options – breakdown order code:

	IM	2	1	V	R	5	B.	0	0	0	2.	6	7	2	x	D	
Basic type M-Line																	Dimension
																	<input type="checkbox"/> D physical unit
Installation depth																	Version
89 mm																	<input type="checkbox"/> x internal version
incl. plug-in terminal																	
Housing size																	Switching points
96x48x70 mm (BxHxD)																	<input type="checkbox"/> 0 no switching point
																	<input type="checkbox"/> 2 2 relay outputs
Display type																	Protection class
V, A																	<input type="checkbox"/> 1 without keypad, operation via PM-TOOL
Display colour																	<input type="checkbox"/> 7 IP65 / plug-in terminal
Blue																	
Green																	
Red																	
Orange																	
Number of digits																	Supply voltage
5 digits																	<input type="checkbox"/> 4 115 VAC
																	<input type="checkbox"/> 5 230 VAC
																	<input type="checkbox"/> 6 10-30 VDC galv. isolated
Digit height																	Measuring input
14 mm																	<input type="checkbox"/> 2 Shunt 0-60-150-300-1000 mV
Digital input																	Analogoutput
none																	<input type="checkbox"/> 0 without
one																	<input type="checkbox"/> X 0-10 VDC, 0/4-20 mA
																	Sensor supply
																	<input type="checkbox"/> 0 without

Please state physical unit by order, e.g. A.

Contents

1. Brief description	1
2. Assembly	2
3. Electrical connection	3
4. Functions and operation description	4
4.1. Programming software PM-TOOL	5
5. Setting up the device	6
5.1. Switching on	6
5.2. Standard parameterisation (flat operation level)	6
Value assignment for triggering of the signal input	
5.3. Programming interlock „RUN“	10
Activation/Deactivation of the programming interlock or change into the professional level, respectively back into the flat operation level	
5.4. Extended parameterisation (professional operation level)	10
5.4.1. Signal input parameters <i>IMP</i>	10
Value assignment for triggering of the signal input incl. linearisation	
5.4.2. General device parameters <i>FCT</i>	14
Higher device functions like Hold, Tara, min/max permanent, setpoint function respectively nominal value function, average determination, brightness control, as well as the control of the digital input and the keyboard configuration	
5.4.3. Safety parameters <i>COD</i>	19
Assignment of user and master code for locking or access to certain parameters like e.g. analog output and alarms, etc.	
5.4.4. Analog output parameters <i>OUT</i>	20
Analog output functions	
5.4.5. Relay functions <i>REL</i>	22
Parameter for the definition of the setpoints	
5.4.6. Alarm parameters <i>AL1...AL4</i>	25
Activator and dependencies of the alarms	
5.4.7. Totaliser (Volume metering) <i>TOT</i>	27
Parameter for calculation of the sum function	
6. Reset to factory settings	29
Reset of the parameter to the factory default settings	
7. Alarms / Relays	29
Function principle of the switching outputs	
8. Sensor alignment	31
Function diagram for sensors with existing trimming resistor	
9. Technical data	32
10. Safety advices	34
11. Error elimination	35

1. Brief description

The panel meter **IM2** is a 5-digit device for direct voltage signals and a visual threshold value monitoring via the display. The configuration happens via four front keys or via the optional PC software PM-TOOL. An integrated programming interlock prevents unrequested changes of the parameters and can be unlocked again by an individual code. Optional the following functions are available: a supply for the sensor, a digital input for triggering of Hold (Tara) or an analog output for further processing in the equipment.

By use of the two optional galvanic isolated setpoints, free adjustable threshold values can be controlled and reported to a superior master display.

The electrical connection is carried out on the back side via plug-in terminals.

Selectable functions like e.g. the request of the min/max-value, an average determination of the measuring signals, a nominal preset respectively setpoint preset, a direct change of threshold value in operation mode and additional measuring supporting points for linearisation complete the modern device concept.

2. Assembly

Please read the *Safety advices* on *page 34* before installation and keep this user manual for future reference.

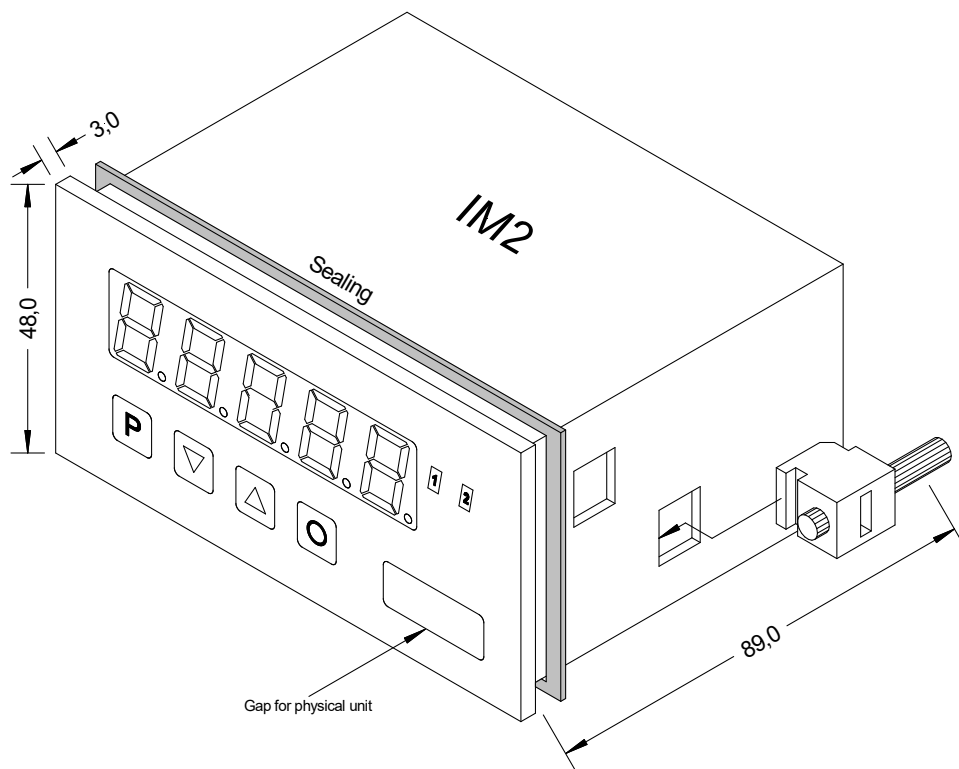

1. After removing the fixing elements, insert the device.
2. Check the seal to make sure it fits securely.
3. Click the fixing elements back into place and tighten the clamping screws by hand. Then use a screwdriver to tighten them another half a turn.

CAUTION! The torque should not exceed 0.1 Nm!

The dimension symbols can be exchanged before installation via a channel on the side!

3. Electrical connection

Type IM2-1VR5B.0002.470xD with a supply of 115 VAC

Type IM2-1VR5B.0002.570xD with a supply of 230 VAC

Type IM2-1VR5B.0002.670xD with a supply of 10-30 VDC

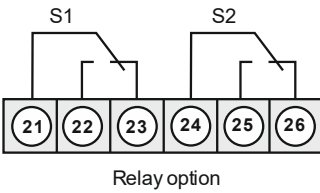
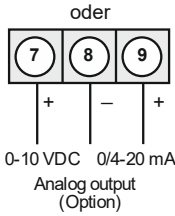
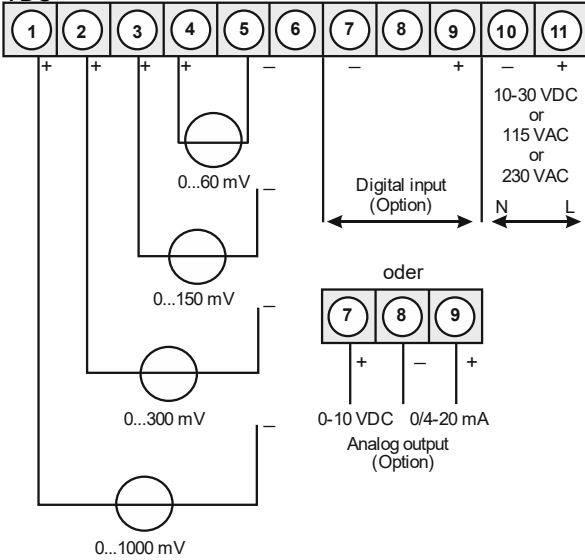

IM2 with digital input in combination with 24 VDC sensor supply

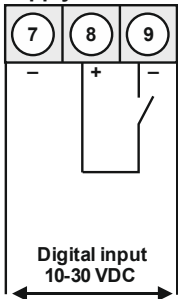

IM2 with digital input and external voltage supply source

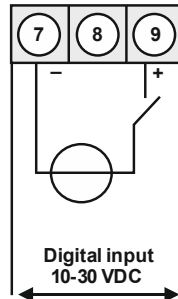

4. Function and operation description

Operation

The operation is divided into three different levels.

Menu level (delivery status)









This level is for the standard settings of the device. Only menu items which are sufficient to set the device into operation are displayed. To get into the professional level, run through the menu level and parameterise *PROF* under menu item *RUN*.

Menu group level (complete function volume)

Suited for complex applications as e.g. linkage of alarms, setpoint treatment, totaliser function etc. In this level function groups which allow an extended parameterisation of the standard settings are available. To leave the menu group level, run through this level and parameterise *ULOC* under menu item *RUN*.

Parameterisation level:

Parameter deposited in the menu item can be parameterised here. Functions, that can be changed or adjusted, are always signalled by a flashing of the display. Settings that are made in the parameterisation level are confirmed with **[P]** and thus saved. By pressing the **[O]**-key (zero-key) it leads to a break-off of the value input and to a change into the menu level. All adjustments are saved automatically by the device and it changes into operating mode, if no further key operation is done within the next 10 seconds.

Level	Key	Description
Menu level		Change to parameterisation level and deposited values.
		Keys for up and down navigation in the menu level.
		Change into operation mode.
Parameterisation level		To confirm the changes made at the parameterization level.
		Adjustment of the value / the setting.
		Change into menu level or break-off in value input.
Menu group level		Change to menu level.
		Keys for up and down navigation in the menu group level.
		Change into operation mode or back into menu level.

Function chart:

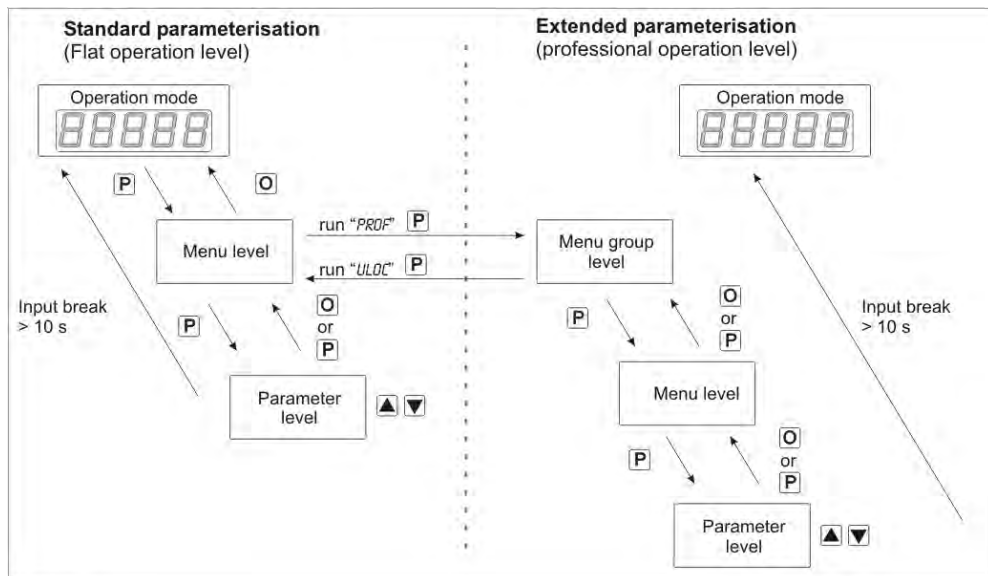

Underline:

- P** Takeover
- O** Stop
- ▲** Value selection (+)
- ▼** Value selection (-)

4.1 Parameterisation software PM-TOOL:

Part of the PM-TOOL are the software on CD and an USB-cable with device adapter. The connection happens via a 4-pole micromatch-plug on the back side of the device, to the PC-side the connection happens via an USB plug.

System requirements: PC incl. USB interface
 Software: Windows XP, Windows VISTA

With this tool the device configuration can be generated, omitted and saved on the PC. The parameters can be changed via the easy to handle program surface, whereat the operating mode and the possible selection options can be preset by the program.

5. Setting up the device

5.1. Switching-on

Once the installation is complete, start the device by applying the voltage supply. First, check once again that all electrical connections are correct.

Starting sequence

For 1 second during the switching-on process, the segment test (8 8 8 8) is displayed followed by an indication of the software type and, after that, also for 1 second the software version. After the starting sequence, the device switches to operation/display mode.

5.2. Standard parameterisation: (Flat operation level)

To parameterise the display, press the **[P]** key in operating mode for 1 second. The display then changes to the menu level with the first menu item *TYPE*.

Menu level

Parameterisation level

Selection of the input signal, *TYPE*:

Default: *SU.060*

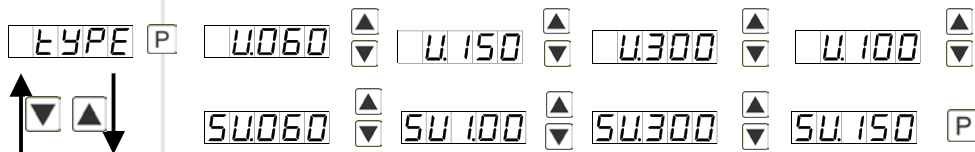

There are several measuring input options: 60, 150, 600 or 1000 mV signals as works calibration (without application of the sensor signal) and *SU* as sensor calibration (with the sensor applied). Confirm the selection with **[P]** and the display switches back to menu level.

Setting the end value of the measuring range, *END*:

Default: *10000*

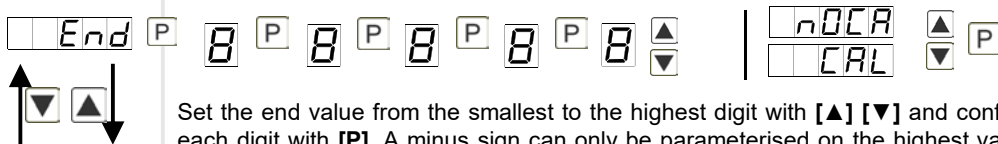

Set the end value from the smallest to the highest digit with **[▲]** **[▼]** and confirm each digit with **[P]**. A minus sign can only be parameterised on the highest value digit. After the last digit, the display switches back to the menu level. If *SEMS* was selected as input option, one can only select between *NOCA* and *CAL*. With *NOCA*, only the previously set display value is taken over, and with *CAL*, the device takes over both the display value and the analogue input value.

Setting the start/offset value of the measuring range, *OFFS*:

Default: *0*

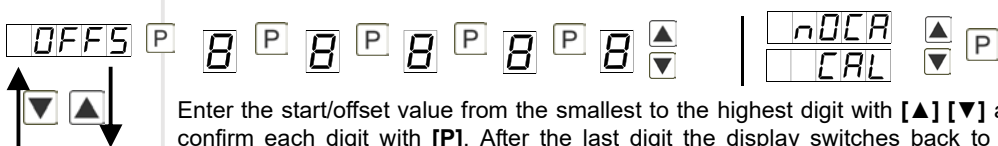

Enter the start/offset value from the smallest to the highest digit with **[▲]** **[▼]** and confirm each digit with **[P]**. After the last digit the display switches back to the menu level. If *SEMS* was selected as input option, one can only select between *NOCA* and *CAL*. With *NOCA*, only the previously set display value is taken over, and with *CAL*, the device takes over both the display value and the analogue input value.

Menu level

Parameterisation level

Setting the comma/decimal point, *DOT*:

Default: 0

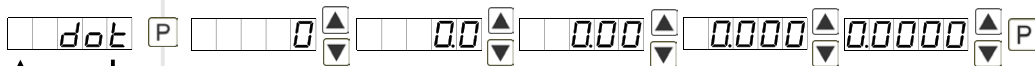

The decimal point on the display can be moved with [▲] [▼] and confirmed with [P]. The display then switches back to the menu level again.

Setting up the display time, *SEC*:

Default: 1.0

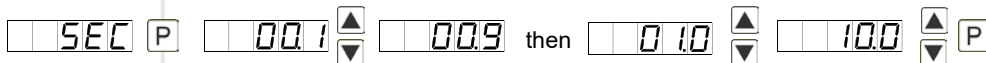

The display time is set with [▲] [▼]. The display moves up in increments of 0.1 up to 1 second and in increments of 1.0 up to 10.0 second. Confirm the selection by pressing the [P] button. The display then switches back to the menu level again.

Selection of analog output, *OUT.RA*:

Default: 4-20



Three output signals are available: 0-10 VDC, 0-20 mA and 4-20 mA, with this function, the demanded signal is selected.

Setting up the final value of the analog output, *OUT.EN*:

Default: 10000



The final value is adjusted from the smallest digit to the highest digit with [▲] [▼] and digit by digit confirmed with [P]. A minus sign can only be parameterised on the highest digit. After the last digit, the device changes back into menu level.

Setting up the initial value of the analog output, *OUT.OF*:

Default: 0



The final value is adjusted from the smallest digit to the highest digit with [▲] [▼] and digit by digit confirmed with [P]. A minus sign can only be parameterised on the highest digit. After the last digit, the device changes back into menu level.

Menu level

Parameterisation level

Threshold values / Limit values, LI-1:

Default: 2000

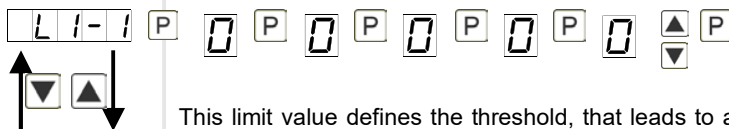

This limit value defines the threshold, that leads to an activation / deactivation of the alarm.

Hysteresis for limit values, HY-1:

Default: 0



The difference to the threshold value that causes the delay of the actuation of the alarm, is defined by the hysteresis.

Function if display falls below / exceeds limit value, FU-1:

Default: HIGH

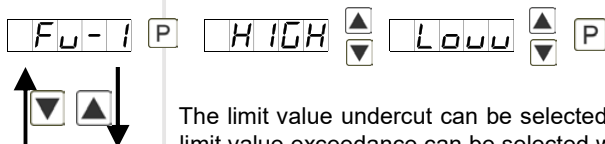

The limit value undercut can be selected with *LOW* (LOW = lower limit value) and limit value exceedance can be selected with *HIGH* (HIGH = upper limit value). If e.g. limit value 1 is on a switching threshold of 100 and occupied with function *HIGH*, the alarm will be activated by reaching the threshold. If the limit value is allocated to *LOW*, an alarm will be activated by undercut of the threshold.

Threshold values / Limit values, LI-2:

Default: 3000



This limit value defines the threshold, that leads to an activation / deactivation of the alarm.

Hysteresis for threshold values, HY-2:

Default: 0

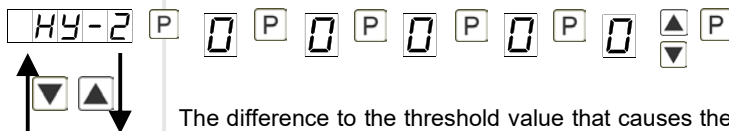

The difference to the threshold value that causes the delay of the actuation of the alarm, is defined by the hysteresis.

Menu level

Parameterisation level

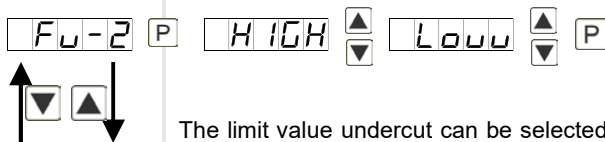
Function if display falls below / exceeds limit value, *FU-2*:Default: *HIGH*

The limit value undercut can be selected with *LOWU* (LOW = lower limit value) and limit value exceedance can be selected with *HIGH* (HIGH = upper limit value). If e.g. limit value 1 is on a switching threshold of 100 and occupied with function *HIGH*, the alarm will be activated by reaching the threshold. If the limit value is allocated to *LOW*, an alarm will be activated by undercut of the threshold.

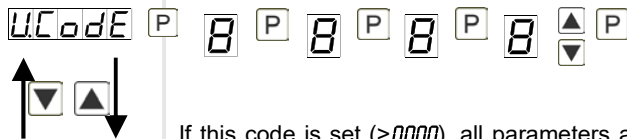
User code (4-digit number-combination, free available), *U.CODE*:Default: *0000*

If this code is set (>0000), all parameters are locked for the user, if *LOC* has been selected under menu item *RUN*. By pressing [**P**] for approx. 3 seconds in operation mode, the message *CODE* is shown in the display. Enter the preset *U.CODE* to get access to the set of parameters which are released for the user. The code needs to be entered before each try of parameterisation, as long as *R.CODE* (Master code) releases all parameters again.

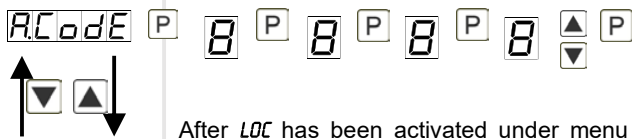
Master code (4-digit number-combination free available), *R.CODE*:Default: *1234*

After *LOC* has been activated under menu item *RUN*, this code can be used for releasing all parameters. By pressing [**P**] for approx. 3 seconds in operation mode, the message *CODE* is shown in the display and offer the user access to all parameters by entering *R.CODE*. While leaving this parameterisation it can be released permanently under *RUN* by selecting *ULOC* or *PROF*. So, at an anew pressing of [**P**] in operating mode, an anew entering of the code is not needed.

Menu level	Parameterisation level
------------	------------------------

5.3. Programming interlock *RUN*

Activation / Deactivation of the programming interlock or completion of the standard parameterisation with change into menu group level (complete function volume), *RUN*:

Default: *ULOC*

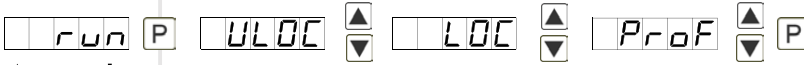

With the navigation keys [▲] [▼], choose between the deactivated key lock *ULOC* (works setting), the activated key lock *LOC*, or the menu group level *PROF*. Confirm the selection with [P]. After this, the display confirms the settings with "- - - -", and automatically switches to operating mode. If *LOC* was selected, the keyboard is locked. To get back into menu level, press [P] for 3 seconds in operating mode. Now enter the *CODE* (works setting *1234*) that appears using [▲] [▼] plus [P] to unlock the keyboard. *FAIL* appears if the input is wrong. To parameterise further functions, *PROF* needs to be set. The device confirms this setting with „- - - -“, and changes automatically into operation mode. By pressing [P] for approx. 3 seconds in operation mode, the first menu group *INP* is shown in the display and thus confirms the change into the extended parameterisation. It stays as long activated as *ULOC* is entered in menu group *RUN*, thus the display is set back in standard parameterisation again.

5.4. Extended parameterisation (Professional operation level)

5.4.1. Signal input parameters

Menu group level

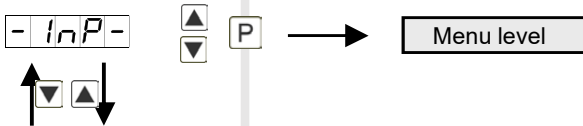

Menu level	Parameterisation level
------------	------------------------

Selection of the input signal, *TYPE*:

Default: *SU.060*

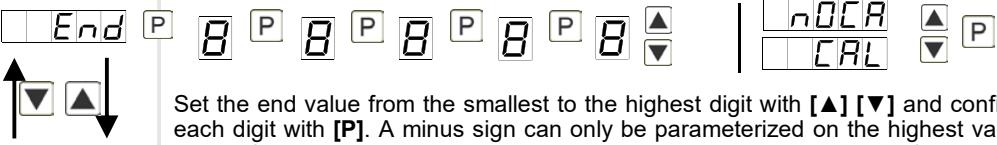
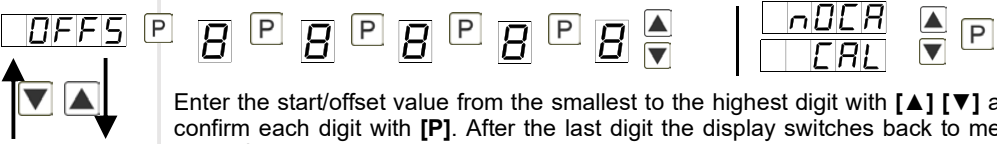
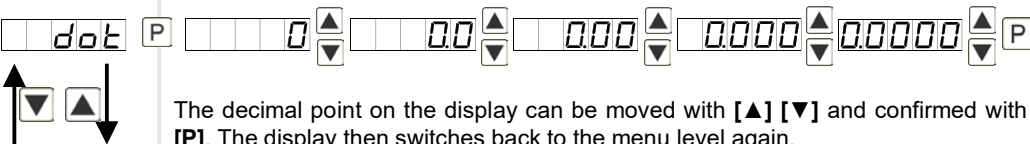
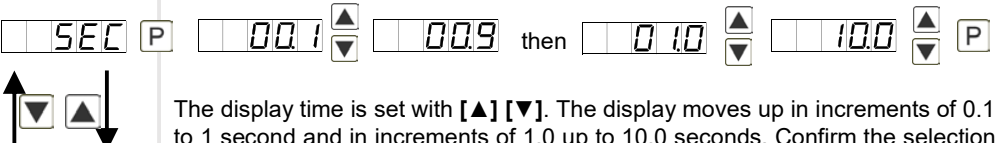
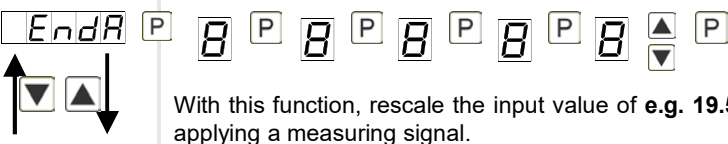

There are several measuring input options: 60, 150, 600 or 1000 mV signals as works calibration (without application of the sensor signal) and *SU* as sensor calibration (with the sensor applied). Confirm the selection with [P] and the display switches back to menu level.

Menu level	Parameterisation level
	<p>Setting the end value of the measuring range, <i>END</i>: Default: 10000</p> <p>Set the end value from the smallest to the highest digit with [▲] [▼] and confirm each digit with [P]. A minus sign can only be parameterized on the highest value digit. After the last digit, the display switches back to menu level. If <i>SENS</i> was selected as input option, one can only select between <i>NOCA</i> and <i>CAL</i>. With <i>NOCA</i>, only the previously set display value is taken over, and with <i>CAL</i>, the device takes over both the display value and the analog input value</p>
	<p>Setting the start/offset value of the measuring range, <i>OFFS</i>: Default: 0</p> <p>Enter the start/offset value from the smallest to the highest digit with [▲] [▼] and confirm each digit with [P]. After the last digit the display switches back to menu level. If <i>SENS</i> was selected as input option, one can only select between <i>NOCA</i> and <i>CAL</i>. With <i>NOCA</i>, only the previously set display value is taken over, and with <i>CAL</i>, the device takes over both the display value and the analogue input value.</p>
	<p>Setting the comma, decimal point, <i>DOT</i>: Default: 0</p> <p>The decimal point on the display can be moved with [▲] [▼] and confirmed with [P]. The display then switches back to the menu level again.</p>
	<p>Setting up the display time, <i>SEC</i>: Default: 1.0</p> <p>The display time is set with [▲] [▼]. The display moves up in increments of 0.1 up to 1 second and in increments of 1.0 up to 10.0 seconds. Confirm the selection by pressing the [P] button. The display then switches back to the menu level again.</p>
	<p>Rescaling the measuring input values, <i>ENDR</i>: Default: 10000</p> <p>With this function, rescale the input value of e.g. 19.5 mA (works setting) without applying a measuring signal.</p>

Menu level

Parameterisation level

OFFSA

P

8

P

8

P

8

P

8

P

8

P

8

▲

▼

P

**Rescaling the measuring input values, OFFSA:**

Default: 0

With this function, rescale the input value of e.g. **3.5 mA** (works setting) without applying a measuring signal.

TARA

P

0

P

0

P

0

P

0

P

0

P

0

▲

▼

P

**Setting up the tare/offset value, TARA:**

Default: 0

The given value is added to the linearized value. In this way, the characteristic line can be shifted by the selected amount.

ADJPT

P

0

P

0

P

0

P

0

P

0

P

0

▲

▼

P

**Setting up the balance point, ADJ.PT:**

Default: 08000

The balance point for the final value can be chosen (in %) from the measuring range by *SU.XXX*. The preset 80.000% result from the widespread detuning of the melt pressure sensors.

Unit

P

C

▲

▼

F

▲

▼

L

▲

▼

A

▲

▼

U

▲

▼

E

▲

▼

no

▲

▼

P

**Setting up the physical unit, UNIT:**

Default: NO

One can choose between the above shown physical units. It will be displayed on the 5th digit of the display, thus the range of value is limited to -1999...9999.

SPCT

P

0

▲

▼

0

▲









▼

P

**Number of additional setpoints, SPCT:**

Default: 00

30 additional setpoints can be defined to the initial value and final value, so linear sensor values are not linearised. Only activated setpoint parameters are displayed.

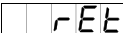
Menu level	Parameterisation level
	<p>Display values for setpoints, DIS.01 ... DIS.30:</p>  <p>Under this parameter setpoints are defined according to their value. At the sensor calibration, like at final value/offset, one is asked at the end if a calibration shall be activated.</p>
	<p>Analog values for setpoints, INP.01 ... INP.30:</p>  <p>The setpoints are always preset according to the selected input signal mA/V. The demanded analog values can be freely adjusted in ascending order.</p>
	<p>Device undercut, DI.UND: Default: -19999</p>  <p>With this function the device undercut (_ _ _ _) can be defined on a definite value. Exception is input type 4-20 mA, it already shows undercut at a signal <1 mA, so a sensor failure is marked.</p>
	<p>Display overflow, DI.QUE: Default: 99999</p>  <p>With this function the display overflow (-----) can be defined on a definite value.</p>
	<p>Back to menu group level, RET:</p>  <p>With [P] the selection is confirmed and the device changes into menu group level „-INP-“.</p>

5.4.2. General device parameters

Menu group level

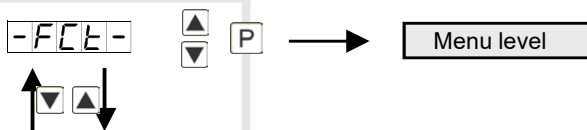

Menu level

Parameterisation level

Display time, *DISC*:

Default: 01.0

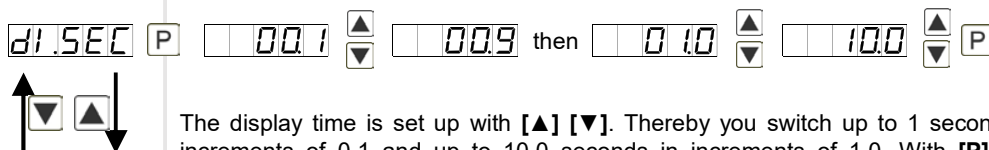

The display time is set up with [**▲**] [**▼**]. Thereby you switch up to 1 second in increments of 0.1 and up to 10.0 seconds in increments of 1.0. With [**P**] the selection is confirmed and the device changes into menu level.

Rounding of display values, *ROUND*:

Default: 00001

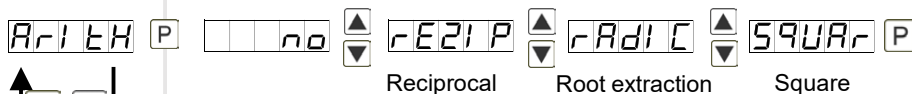

This function is for instable display values, where the display value is changed in steps of 1, 5, 10 or 50. This does not affect the resolution of the optional outputs. With [**P**] the selection is confirmed and the device changes into menu level.

Arithmetics, *ARITH*:Default: *NO*

With this function the calculated value, not the measuring value, is shown in the display. Calculation types:







rEZIP = (Final value*Final value)/Display value

rAdiC = Root(Display value*Final value)

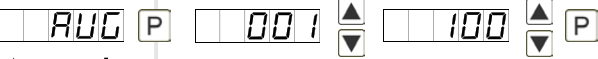
SqUAr = (Display value)²/Final value

Advice: The denominator of fractions should not be 0 because a division by 0 is not possible. It creates an undefined state and the display goes into the overflow.

With *NO*, no calculation is deposited. With [**P**] the selection is confirmed and the device changes into menu level.

Menu level	Parameterisation level
	<p>Sliding average determination, <i>AVG</i>: Default: 10</p> <p></p> <p>Under this menu item, the number of measurements that need to be averaged are preset. The averaging time results from the product of measuring time <i>SEC</i> and the averaged measurements <i>AVG</i>. With selection of <i>AVG</i> in menu level <i>DISPL</i> the result is shown in the display and evaluated when entered in the alarm <i>ALI-AL4</i> or the analog output <i>OUTPT</i>.</p>
	<p>Zero point slowdown, <i>ZERO</i>: Default: 00</p> <p></p> <p>At the zero point slowdown, a value range around the zero point can be preset, so the display shows a zero. If e.g.10 is set, the display would show a zero in the value range from -10 to +10; below continue with -11 and beyond with +11. The maximum adjustable range of value is 99.</p>
	<p>Solid constant value, <i>CONST</i>: Default: 0</p> <p></p> <p>The constant value can be evaluated like the current measurand via the alarms or the analog output. The decimal place cannot be changed for this value and is taken over from the current measurand. So, with this value a setpoint generator can be realised via the analog output. Furthermore it can be used as calculated difference. At this the constant value needs to be subtracted from the current measurand and the difference is evaluated in the alerting or via the analog output. Thus regulation can be displayed quite easy with this parameterisation.</p>
	<p>Minimum constant value, <i>CON.MI</i>: Default: -19999</p> <p></p> <p>The minimum constant value is selected and adjusted from the smallest to the highest digit with [▲] [▼] and confirmed digit per digit with [P]. A minus sign can only be adjusted on the highest digit. After the last digit the display changes back into menu level.</p>

Menu level

Parameterisation level

Maximum constant value, *CON.NR*:

Default: 99999

 conNR [P] 8 [P] 8 [P] 8 [P] 8 [P] 8 [▲] [▼] [P]

The maximum constant value is selected and adjusted from the smallest to the highest digit with [▲] [▼] and confirmed digit per digit with [P]. A minus sign can only be adjusted on the highest digit. After the last digit the display changes back into menu level.

Display, *DISPL*:

Default: ACTUR

 di SPL [P] ActUR [▲] [▼] minUR [▲] [▼] MAXUR [▲] [▼] totAL [▲] [▼]
 HoLD [▲] [▼] AUG [▲] [▼] const [▲] [▼] dIFF [▲] [▼] [P]

With this function the current measurand, the min/max-value, the totaliser, the process-controlled hold-value, the sliding average value, the constant value or the difference between constant value and current value can be allocated to the display. With [P] the selection is confirmed and the device changes into menu level.

Brightness control, *LIGHT*:

Default: 15

 LIgHE [P] 00 [▲] [▼] 15 [▲] [▼] [P]

The brightness of the display can be adjusted in 16 levels from 00 = very dark to 15 = very bright via this parameter or alternatively via the navigation keys from the outside. During the start of the device the level that is deposited under this parameter will always be used, even though the brightness has been changed via the navigation keys in the meantime.

Display flashing, *FLASH*:

Default: NO

 FLASH [P] no [▲] [▼] AL-1 [▲] [▼] AL-2 [▲] [▼] AL12 [▲] [▼]
 AL-3 [▲] [▼] AL-4 [▲] [▼] AL34 [▲] [▼] ALAL [▲] [▼] [P]

A display flashing can be added as additional alarm function either to single or to a combination of off-limit condition. With NO, no flashing is allocated.

Menu level

Parameterisation level

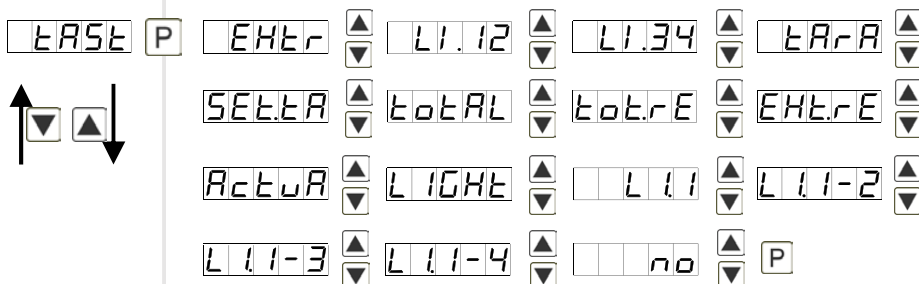
Assignment (deposit) of key functions, *TAST*:Default: *NO*

For the operation mode, special functions can be deposited on the navigation keys [▲] [▼], in particular the function min/max-memory is activated with *EHTR*, all measured min/max-values are saved during operation and can be recalled via the navigation keys. The values get lost by restart of the device. If the threshold value correction *LI.12* or *LI.34* is chosen, the values of the threshold can be changed during operation without disturbing the operating procedure. With *TARA* the device is set temporarily on a parameterised value. The device acknowledges the correct taring with showing *00000* in the display. *SET.TA* switches into the offset value and can be adjusted via the navigation keys. Via *TOTAL* the current value of the totaliser can be displayed for approx. 7 seconds, after this the device switches back on the parameterised display value. If *TOT.RE* is deposited, the totaliser can be set back by pressing of the navigation keys [▲] [▼], the device acknowledges this with showing *00000* in the display. By allocation on *EHT.RE* the min/max-memory is deleted. At *ACTUA* the measuring value is shown for approx. 7 seconds, after this the device switches back on the parameterised display value. With *LIGHT* the brightness of the display is adjusted. This setting is not saved and gets lost at a restart fo the device. Via selection *L11*, *L11-2*, *L11-3*, *L11-4* threshold values can be addressed via the navigation keys; they can be changed digit per digit or taken over by pushing the [P]-key. The adjustment is taken over directly, an existing limit value monitoring and the current measurement will not be influenced by this. If *NO* is selected, the navigation keys are without any function in the operation mode.

Menu level

Parameterisation level

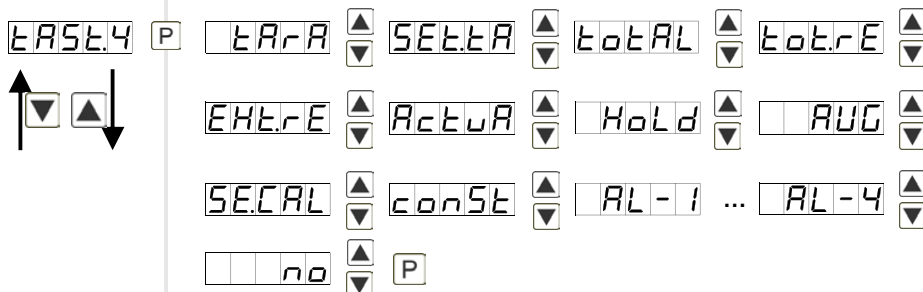
Special function [O]-key, *TAST.4*:Default: *NO*

For operation mode, special functions can be deposited on the [O]-key. Activate this function by pressing the key. With *TARA* the device is set temporarily on zero and saved permanently as offset. The device acknowledges the correct taring by showing *00000*. *SET.TA* switches into the offset value and can be adjusted via the navigation keys. Via *TOTAL* the current value of the totaliser can be displayed for approx. 7 seconds, after this the device switches back on the parameterised display value. If *TOT.RE* is deposited, the totaliser can be set back by pressing of the navigation keys [▲] [▼], the device acknowledges this with showing *00000*. *EHT.RE* deletes the min/max-memory. If *HOLD* has been selected, the moment can be hold constant by pressing the [O]-key, and is updated by releasing the key. **Advice:** *HOLD* is activated only, if *HOLD* was selected under parameter *DISPL*. *ACTUA* shows the measuring value for approx. 7 seconds, after this the device switches back on the parameterised display value. The same goes for *AVG*, here the sliding average value will be displayed. Via *SE.CAL* a sensor calibration is done by pressing the zero key, the operating diagram is shown in *chapter 8*. The constant value *CONST* can be called up via the key or adjusted digit per digit. At *AL-1...AL-4* an output can be set and therewith can e.g. a setpoint adjustment be done. If *NO* is selected, the [O]-key is without any function in the operation mode.

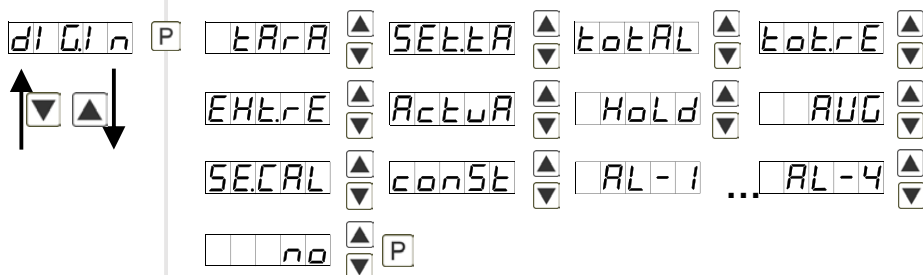
Special function digital input, *DIG.IN*:Default: *NO*

For the operation mode, the above shown parameters can be laid on the optional digital input, too. Functions description see *TAST.4*.



Menu level	Parameterisation level
	<p>Back to menu group level, RET:</p> <p>With [P] the selection is confirmed and the device changes into menu group level „-FCT-“.</p>

5.4.3. Safety parameters

Menu group level







Menu level	Parameterisation level
	<p>Adjustment of user code, U.CODE: Default: 0000</p> <p>Via this code reduced sets of parameters <i>OUT.LE</i> and <i>RL.LEV</i> can be released during locked programming. Further parameters are not available via this code. The <i>U.CODE</i> can only be changed via the correct input of the <i>R.CODE</i> (Master code).</p>
	<p>Master code, R.CODE: Default: 1234</p> <p>By entering <i>R.CODE</i> the device will be released and all parameters unlocked.</p>
	<p>Release/ lock analog output parameters, OUT.LE: Default: ALL</p> <p>Analog output parameters can be locked or released for the user:</p> <ul style="list-style-type: none"> - <i>EN-OF</i>: the initial or final value can be changed in operation mode. - <i>OUT.EO</i>: output signal can be changed from e.g. 0-20mA to 4-20mA or 0-10VDC. - <i>ALL</i>: analog output parameters are released. - <i>NO</i>: all analog output parameters are locked

Menu level	Parameterisation level
	<p>Release/lock alarm parameters, <i>AL.LEU</i>: Default: <i>ALL</i></p> <p><i>AL.LEU</i> [P] [] <i>no</i> [▲] [▼] <i>LIMIT</i> [▲] [▼] <i>ALRM.L</i> [▲] [▼] [] <i>ALL</i> [▲] [▼] [P]</p> <p>This parameter describes the user release/user lock of the alarm:</p> <ul style="list-style-type: none"> - <i>LIMIT</i>: here only the range of value of the threshold values 1-4 can be changed. - <i>ALRM.L</i>: here the range of value and the alarm trigger can be changed. - <i>ALL</i>: all alarm parameters are released. - <i>NO</i>: all alarm parameters are locked.
	<p>Back to menu group level, <i>RET</i>:</p> <p>With [P] the selection is confirmed and the device changes into menu group level „-COD-“.</p>

5.4.4. Analog output parameters

Menu group level
 <p><i>-OUT-</i> [▲] [▼] [P] → Menu level</p>

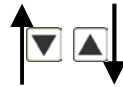
Menu level	Parameterisation level
	<p>Selection reference analog output, <i>OUTPT</i>: Default: <i>ACTUA</i></p> <p><i>OUTPT</i> [P] <i>ACTUA</i> [▲] [▼] <i>MINUA</i> [▲] [▼] <i>MAXUA</i> [▲] [▼] <i>TOTAL</i> [▲] [▼]</p> <p><i>HOLD</i> [▲] [▼] [] <i>AUG</i> [▲] [▼] <i>CONST</i> [▲] [▼] <i>DIFF</i> [▲] [▼] [P]</p> <p>The analog output signal can refer to different functions, in detail this are the current measurand, min/max-value or totaliser function/sum-function, the sliding average value, the constant value or the difference between the current value and the constant value. If <i>HOLD</i> was selected the signal of the analog output will be hold and processed just after deactivation of <i>HOLD</i>. With [P] the selection is confirmed and the device changes into menu level.</p>

Menu level	Parameterisation level
	<p>Selection analog output, <i>OUT.RA</i>: Default: 4-20</p> <p><i>OUT.RA</i> P 0-10 0-20 4-20 P</p> <p>Available are 3 output signals: 0-10 VDC, 0-20 mA and 4-20 mA. With this function the demanded signal can be selected.</p>
	<p>Setting up the final value of the analog output, <i>OUT.EM</i>: Default: 10000</p> <p><i>OUT.EM</i> P 8 P 8 P 8 P 8 P 8 P</p> <p>The final value can be adjusted from the smallest to the largest digit with [▲] [▼]. Confirm each digit with [P]. A minus sign can only be parameterized on the highest value digit. After the last digit, the display switches back to the menu level.</p>
	<p>Setting up the initial value of the analog output, <i>OUT.OF</i>: Default: 00000</p> <p><i>OUT.OF</i> P 8 P 8 P 8 P 8 P 8 P</p> <p>The initial value can be adjusted from the smallest to the largest digit with [▲] [▼]. Confirm each digit with [P]. A minus sign can only be parameterized on the highest value digit. After the last digit, the display switches back to the menu level.</p>
	<p>Overflow behavior, <i>O.FLOW</i>: Default: <i>EDGE</i></p> <p><i>O.FLOW</i> P <i>EDGE</i> <i>to.END</i> <i>to.OFF</i> <i>to.MIN</i> <i>to.MAX</i> P</p> <p>To recognise and evaluate faulty signals, e.g. by a controller, the overflow behavior of the analog output can be defined. As overflow can be seen either <i>EDGE</i>, that means the analog output runs on the set limits e.g. 4 mA and 20 mA, <i>TO.OFF</i> (input value smaller than initial value, analog output changes on e.g. 4 mA) or <i>TO.END</i> (higher than final value, analog output changes on e.g. 20 mA). If <i>TO.MIN</i> or <i>TO.MAX</i> is set, the analog output changes on the smallest or highest possible binary value. This means that values of e.g. 0 mA, 0 VDC or values higher than 20 mA or 10 VDC can be reached. With [P] the selection is confirmed and the device changes into menu level.</p>
	<p>Back to menu group level, <i>RET</i>:</p> <p>With [P] the selection is confirmed and the device changes into menu group level „-OUT-“.</p>

5.4.5. Relay functions

Menu group level

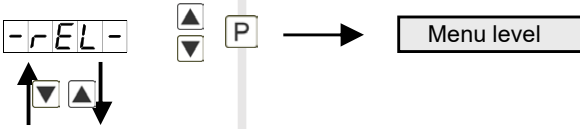

Menu level



Parameterisation level

Alerting relay 1, REL-1:
Default: AL-1

REL-1 P AL-1 ... AL-4 AL-n1 ... AL-n4
 LOGIC OFF ON CAL
 CALOF CALEN P

The screenshot shows the parameterisation level for 'Alerting relay 1, REL-1'. The default is 'AL-1'. The screen displays several parameters: 'REL-1' with a 'P' key, 'AL-1' through 'AL-4', 'AL-n1' through 'AL-n4', 'LOGIC', 'OFF', 'ON', 'CAL', 'CALOF', and 'CALEN'. Each parameter has up and down arrows for navigation. A 'P' key is shown at the end of the 'CALEN' parameter.

Each setpoint (optional) can be linked up via 4 alarms (by default). This can either be inserted at activated alarms *AL1/4* or deactivated alarms *ALN1/4*. If *LOGIC* was selected, logical links are available in the menu levels *LOG-1* and *COM-1*. Access to these two menu levels is via *LOGIC*, at all other selected functions, these two parameters are overleaped. Via *ON/OFF* the setpoints can be activated/deactivated, in this case the output and the setpoint display are set/not set on the front of the device. The parameters *CAL*, *CAL.OF* and *CAL.EN* can only be used in accordance with the semi-automatic calibration (*Chapter 8. Sensor alignment*). At *CAL* the relay switches during sensor calibration, at *CAL.OF* during offset calibration and at *CAL.EN* during the calibration of the final value. With **[P]** the selection is confirmed and the device changes into menu level.

Menu level	Parameterisation level												
	<p>Logic relay 1, LOG-1 Default: OR</p> <p>LOG-1 [P] [] or [] nor [] And [] nAnd [] [P]</p> <p>Here, the switching behavior of the relay is defined via a logic link, the following schema describes these functions with inclusion of <i>AL-1</i> and <i>AL-2</i>. This parameter can only be selected if <i>LOGIC</i> was selected under <i>REL-1</i>.</p> <table border="1"> <tr> <td data-bbox="212 422 347 518">[] or</td> <td data-bbox="352 422 582 518">$A1 \vee A2$</td> <td data-bbox="588 422 1086 518">As soon as a selected alarm is activated, the relay operates. Equates to operating current principle.</td> </tr> <tr> <td data-bbox="212 518 347 614">[] nor</td> <td data-bbox="352 518 582 614">$\overline{A1 \vee A2} = \bar{A1} \wedge \bar{A2}$</td> <td data-bbox="588 518 1086 614">The relay operates only, if no selected alarm is active. Equates to quiescent current principle.</td> </tr> <tr> <td data-bbox="212 614 347 694">[] And</td> <td data-bbox="352 614 582 694">$A1 \wedge A2$</td> <td data-bbox="588 614 1086 694">The relay operates only, if all selected alarms are active.</td> </tr> <tr> <td data-bbox="212 694 347 758">[] nAnd</td> <td data-bbox="352 694 582 758">$\overline{A1 \wedge A2} = \bar{A1} \vee \bar{A2}$</td> <td data-bbox="588 694 1086 758">As soon as a selected alarm is not activated, the relay operates.</td> </tr> </table> <p>With [P] the selection is confirmed and the device changes into menu level.</p>	[] or	$A1 \vee A2$	As soon as a selected alarm is activated, the relay operates. Equates to operating current principle.	[] nor	$\overline{A1 \vee A2} = \bar{A1} \wedge \bar{A2}$	The relay operates only, if no selected alarm is active. Equates to quiescent current principle.	[] And	$A1 \wedge A2$	The relay operates only, if all selected alarms are active.	[] nAnd	$\overline{A1 \wedge A2} = \bar{A1} \vee \bar{A2}$	As soon as a selected alarm is not activated, the relay operates.
[] or	$A1 \vee A2$	As soon as a selected alarm is activated, the relay operates. Equates to operating current principle.											
[] nor	$\overline{A1 \vee A2} = \bar{A1} \wedge \bar{A2}$	The relay operates only, if no selected alarm is active. Equates to quiescent current principle.											
[] And	$A1 \wedge A2$	The relay operates only, if all selected alarms are active.											
[] nAnd	$\overline{A1 \wedge A2} = \bar{A1} \vee \bar{A2}$	As soon as a selected alarm is not activated, the relay operates.											
	<p>Alarms for relay 1, CON-1: Default: A.1</p> <p>CON-1 [P] A.1 [] A.2 [] ... A.1234 [] [P]</p> <p>The allocation of the alarms to relay 1 happens via this parameter, one alarm or a group of alarms can be chosen. This parameter can only be selected if <i>LOGIC</i> was selected under <i>REL-1</i>. With [P] the selection is confirmed and the device changes into menu level.</p>												

Menu level

Parameterisation level

Alerting relay 2, REL-2:

Default: AL-2



REL-2 P AL-5 ... AL-8 ▲▼ AL-n5 ... AL-n8 ▲▼
 LOGIC ▲▼ OFF ▲▼ On ▲▼ CAL ▲▼
 CALOF ▲▼ CALEN ▲▼ P

Each setpoint (optional) can be linked up via 4 alarms (by default). This can either be inserted at activated alarms *AL1/4* or deactivated alarms *ALN1/4*. If *LOGIC* was selected, logical links are available in the menu level *LOG-1* and *COM-1*. Access to these two menu levels is via *LOGIC*, at all other selected functions, these two parameters are overlapped. Via *ON/OFF* the setpoints can be activated/deactivated, in this case the output and the setpoint display are set/not set on the front of the device. The parameters *CAL*, *CAL.OF* and *CAL.EN* can only be used in accordance with the semi-automatic calibration (*Chapter 8. Sensor alignment*). At *CAL* the relay switches during sensor calibration, at *CAL.OF* during offset calibration and at *CAL.EN* during the calibration of the final value. With **[P]** the selection is confirmed and the device changes into menu level.

Logic relay 2, LOG-2:

Default: OR





LOG-2 P or ▲▼ nor ▲▼ And ▲▼ nAnd ▲▼ P

Here, the switching behavior of the relay is defined via a logic link, the following schema describes these functions with inclusion of *AL-1* and *AL-2*. This parameter can only be selected if *LOGIC* was selected under *REL-1*.

<input type="checkbox"/> or	$A1 \vee A2$	As soon as a selected alarm is activated, the relay operates. Equates to operating current principle.
<input type="checkbox"/> nor	$\overline{A1 \vee A2} = \overline{A1} \wedge \overline{A2}$	The relay operates only, if no selected alarm is active. Equates to quiescent current principle.
<input type="checkbox"/> And	$A1 \wedge a2$	The relay operates only, if all selected alarms are active.
<input type="checkbox"/> nAnd	$\overline{A1} \wedge \overline{A2} = \overline{A1} \vee \overline{A2}$	As soon as a selected alarm is not activated, the relay operates.



With **[P]** the selection is confirmed and the device changes into menu level.

Menu level	Parameterisation level
	<p>Alarms for relay 2, CON-2: Default: <i>A.2</i></p> <p>CON-2 [P] A.1 [▲] [▼] A.2 [▲] [▼] ... A.1234 [▲] [▼] [P]</p> <p>The allocation of the alarms to relay 1 happens via this parameter, one alarm or a group of alarms can be chosen. This parameter can only be selected if <i>LOGIC</i> was selected under <i>REL-1</i>. With [P] the selection is confirmed and the device changes into menu level.</p>
	<p>Back to menu group level, RET:</p> <p>RET [P]</p> <p>With [P] the selection is confirmed and the device changes into menu group level „-REL-“.</p>

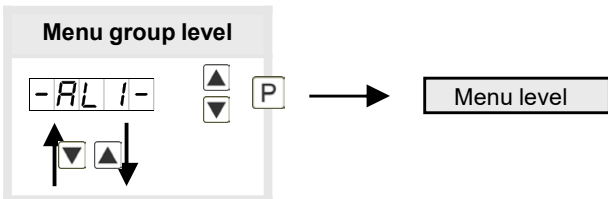
5.4.6. Alarm parameters

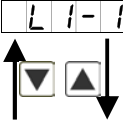
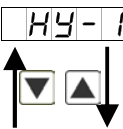
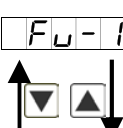
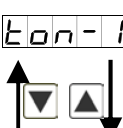
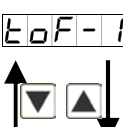

Menu level	Parameterisation level
	<p>Dependency of alarm 1, ALRM.1: Default: <i>ACTUA</i></p> <p>ALRM.1 [P] ACTUA [▲] [▼] MINUA [▲] [▼] MAXUA [▲] [▼] TOTRAL [▲] [▼]</p> <p>HOLD [▲] [▼] AVG [▲] [▼] CONST [▲] [▼] DIFF [▲] [▼]</p> <p>EHTER [▲] [▼] [P]</p> <p>The dependency of alarm 1 can be related to special functions, in detail these are the current measurand, the min-value, the max-value, the totaliser value/sum value, the sliding average value, the constant value or the difference between the current measurand and the constant value. If <i>HOLD</i> was selected the alarm is hold and processed just after deactivation of <i>HOLD</i>. <i>EHTER</i> causes the dependency either by pressing the [O]-key on the front of the housing or by an external signal via the digital input. With [P] the selection is confirmed and the device changes into menu level.</p> <p>Example: Using the maximum value <i>ALARM.1 = MAXUA</i> in combination with a threshold monitoring <i>FU-1 = HIGH</i>, an alarm confirmation can be realised. Use the navigation keys or the 4th key for confirmation.</p>

Menu level	Parameterisation level
	<p>Threshold values / Limits, LI-1: Default: 2000</p> <p>LI-1 P 0 P 0 P 0 P 0 P 0 P ▲ P ▼</p> <p>This limit value defines the threshold, that leads to an activation / deactivation of the alarm.</p>
	<p>Hysteresis for threshold values, HY-1: Default: 00000</p> <p>HY-1 P 0 P 0 P 0 P 0 P 0 P ▲ P ▼</p> <p>The difference to the threshold value that causes the delay of the actuation of the alarm, is defined by the hysteresis.</p>
	<p>Function for threshold value exceedance/undercut, FU-1: Default: HIGH</p> <p>FU-1 P HIGH ▲ LOW ▼ P</p> <p>The limit value undercut can be selected with <i>LOW</i> (LOW = lower limit value) and limit value exceedance can be selected with <i>HIGH</i> (HIGH = upper limit value). If e.g. limit value 1 is on a switching threshold of 100 and occupied with function <i>HIGH</i>, the alarm will be activated by reaching the threshold. If the limit value is allocated to <i>LOW</i>, an alarm will be activated by undercut of the threshold.</p>
	<p>Switching-on delay, TON-1: Default: 000</p> <p>TON-1 P 0 P 0 P 0 ▲ P ▼</p> <p>For limit value 1 one can preset a delayed switching-on of 0-100 seconds.</p>
	<p>Switching-off delay, TOF-1: Default: 000</p> <p>TOF-1 P 0 P 0 P 0 ▲ P ▼</p> <p>For limit value 1 one can preset a delayed switching-off of 0-100 seconds.</p>
	<p>Back to menu group level, RET:</p> <p>RET</p> <p>With [P] the selection is confirmed and the device changes into menu group level „-ALI-“.</p>

The same applies to -AL2- to -AL4-.

5.4.7. Totaliser (Volume metering)

Menu group level

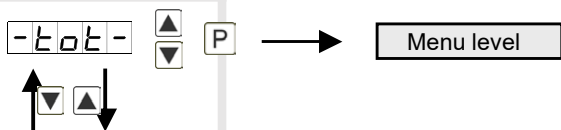

Menu level

Parameterisation level

Totaliser state, TOTAL:

Default: OFF

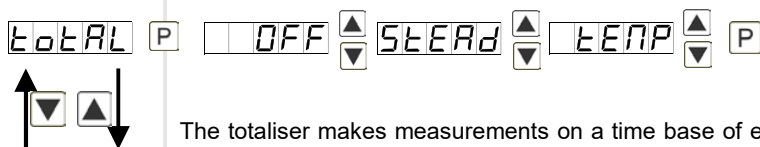

The totaliser makes measurements on a time base of e.g. l/h possible, at this the scaled input signal is integrated by a time and steadily (select *STEAD*) or temporarily (select *TEMP*) saved. Choose the quick storage for numerous filling processes and the permanent storage for consumption measurings. At the permanent storage *STEAD*, the current cumulative value is saved at each totaliser reset and furthermore, every 30 minutes in the non-volatile memory of the device. If *OFF* is selected, the function is deactivated. With [**P**] the selection is confirmed and the device changes into menu level.

Time base, T.BASE:

Default: SEC

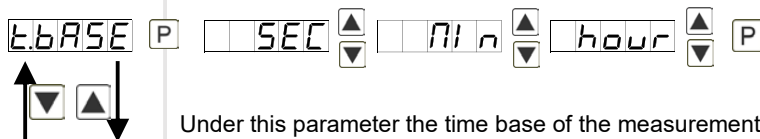



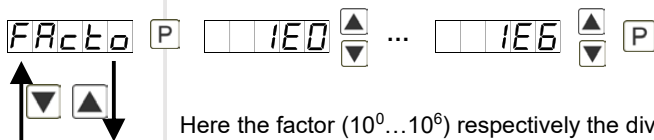

Under this parameter the time base of the measurement can be preset in seconds, minutes or hours.

Totaliser factor, FACTO:

Default: 1E0

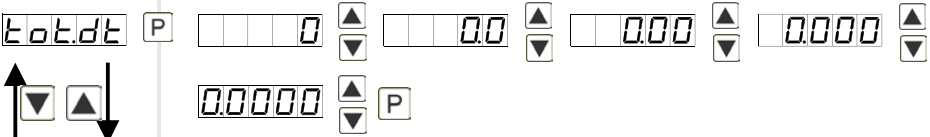

Here the factor ($10^0 \dots 10^6$) respectively the divisor for the internal calculation of the measuring value is assigned.

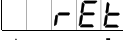
Menu level	Parameterisation level
	<p>Setting up the decimal point for the totaliser, <i>TOT.DT</i>: Default: 0</p>  <p>The decimal point of the device can be adjusted with the navigation keys [▲] [▼]. With [P] the selection is confirmed and the device changes into menu level.</p>
	<p>Totaliser reset, <i>TOT.RE</i>: Default: 00000</p>  <p>The reset value is adjusted from the smallest to the highest digit with the navigation keys [▲] [▼] and digit per digit confirmed with [P]. After the last digit, the display switches back to the menu level. The activator for the reset is parameter driven via the 4th key or via the optional digital input.</p>
	<p>Back to menu group level, <i>RET</i>:</p>  <p>With [P] the selection is confirmed and the device changes into menu group level „-TOT-“.</p>

Programming interlock:

Description see page 10, menu-level *RUN*

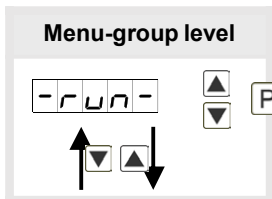

6. Reset to default values

To return the unit to a **defined basic state**, a reset can be carried out to the default values.

The following procedure should be used:

- Switch off the power supply
- Press **[P]** button
- Switch on voltage supply and press **[P]**-button until „- - - -“ is shown in the display.

With reset, the default values of the program table are loaded and used for subsequent operation. This sets the unit back to the state in which it was supplied.

Caution! All application-related data are lost.

7. Alarms / Relays

This device has 4 virtual alarms that can monitor one limit value in regard of an undercut or exceedance. Each alarm can be allocated to an optional relay output S1-S2; furthermore alarms can be controlled by events like e.g. Hold or min/max-value.

Function principle of alarms / relays

Alarm / Relay x	Deactivated, instantaneous value, min/max-value, Hold-value, totaliser value, sliding average value, constant value, difference between instantaneous value and constant value or an activation via the digital input or the [O] -key.
Switching threshold	Threshold / limit value of the change-over
Hysteresis	Broadness of the window between the switching thresholds
Working principle	Operating current / Quiescent current

Operating current

By operating current the alarm S1-S2 is **off** below the threshold and **on** on reaching the threshold.

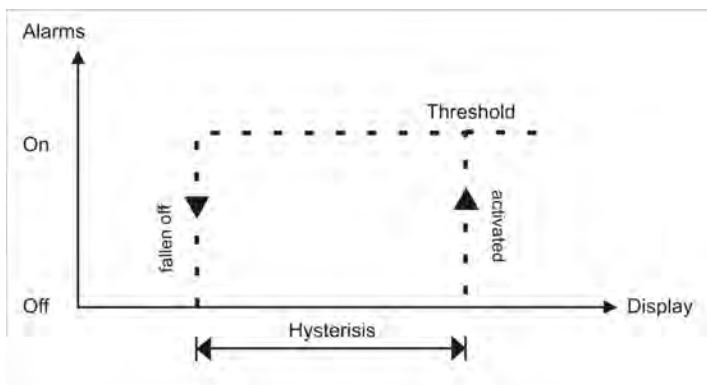

Quiescent current

By quiescent current the alarm S1-S2 is **on** below the threshold and switched **off** on reaching the threshold.

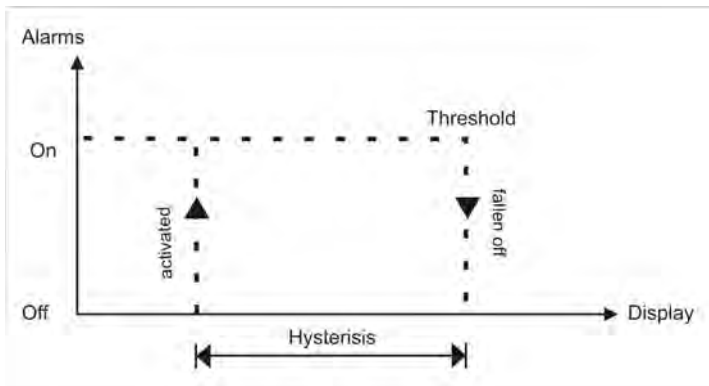

Switching-on delay

The switching-on delay is activated via an alarm and e.g. switched 10 seconds after reaching the switching threshold, a short-term exceedance of the switching value does not cause an alarm, respectively does not cause a switching operation of the relay. The switching-off delay operates in the same way, keeps the alarm / the relay switched longer for the parameterised time.

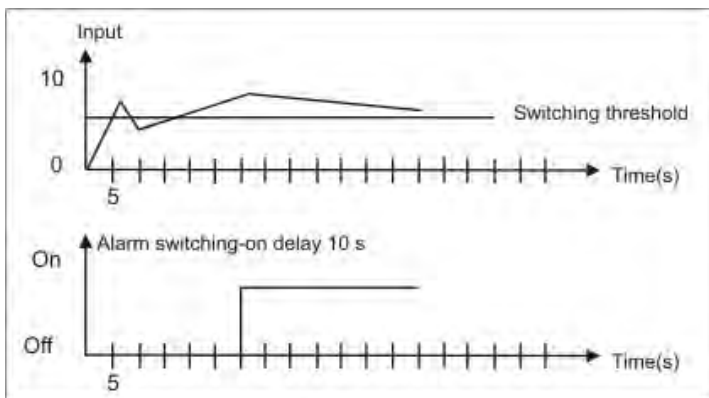

8. Sensor calibration offset / final value

The device is equipped with a semi-automatic sensor calibration (*SUX*). A switching output operates the trimming resistor, which exists in some sensors. An adjustment of offset and final value takes place, after which the sensor can be used directly. Depending on parameterisation, the calibration can be realized via the 4th key or via the digital input. It is possible to key during the calibration steps. So, reference signals can be connected manually. However the calibration will be interrupted after 30 seconds.

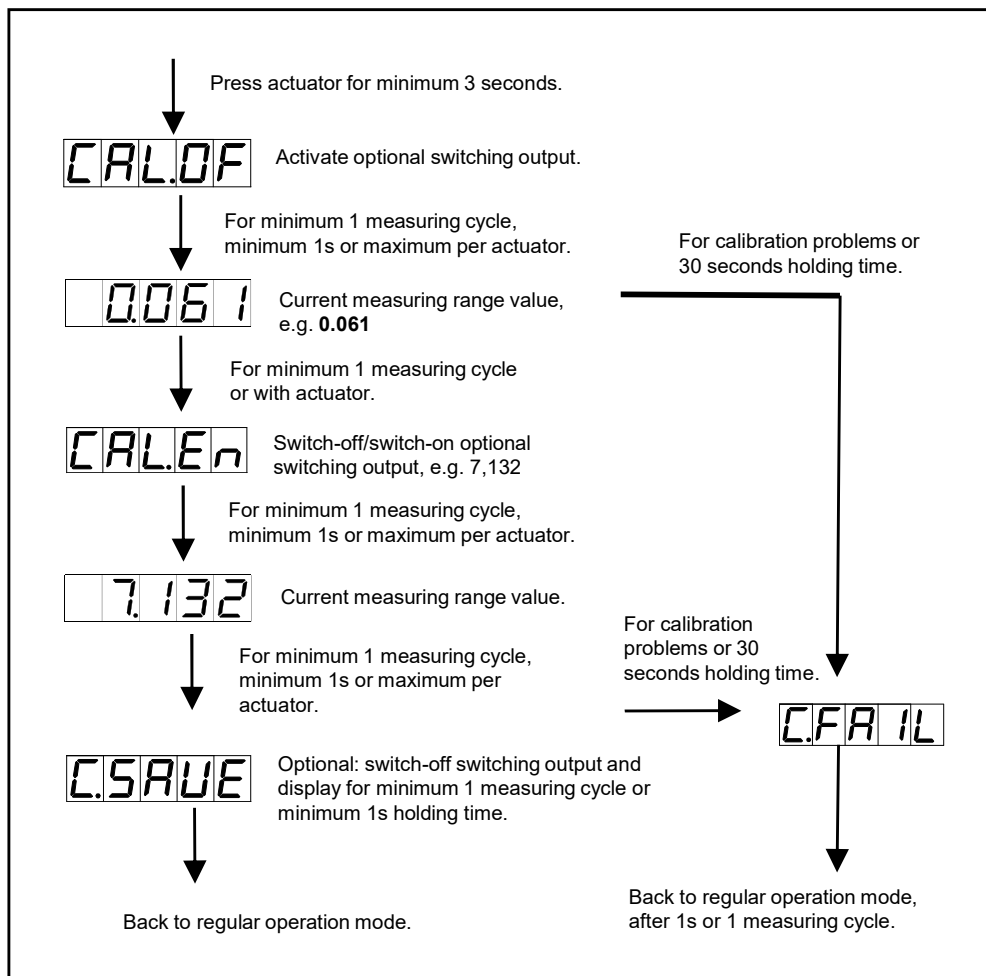

9. Technical data

Housing				
Dimensions	96x48x70 mm (BxHxD)			
	96x48x89 mm (BxHxD) including plug-in terminal			
Panel cut-out	92.0 ^{+0.8} x 45.0 ^{+0.6} mm			
Wall thickness	up to 15 mm			
Fixing	screw elements			
Material	PC Polycarbonate, black, UL94V-0			
Sealing material	EPDM, 65 Shore, black			
Protection class	standard IP65 (Front), IP00 (Back side)			
Weight	approx. 200 g			
Connection	plug-in terminal; wire cross-section up to 2.5 mm ²			
Display				
Digit height	14 mm			
Segment colour	red (optional green, orange or blue)			
Display range	-19999 up to 99999			
Setpoints	one LED per setpoint			
Overflow	horizontal bars at the top			
Underflow	horizontal bars at the top			
Display time	0.1 to 10.0 seconds			
Input	Measuring range	Ri	Measuring error	Digit
-5...75 mV	0...60 mV	~12 kΩ	0.5 % of measur. range	±1
-15...180 mV	0...150 mV	~60 kΩ	0.5 % of measur. range	±1
-30...360 mV	0...300 mV	~30 kΩ	0.5 % of measur. range	±1
-100...1200 mV	0...1000 mV	~200 kΩ	0.5 % of measur. range	±1
Digital input	< 2.4 V OFF, 10 V ON, max. 30 VDC R _I ~ 5 kΩ			
Accuracy				
Temperature drift	100 ppm / K			
Measuring time	0.1...10.0 seconds			
Measuring principle	U/F-conversion			
Resolution	approx. 18 bit at 1 sec measuring time			

Output	
Analog output	0/4-20 mA / burden 350 Ω; 0-10 VDC / burden 10 kΩ, 16 bit
Switching outputs	
Relay with change-over contacts	250 VAC / 5 AAC; 30 VDC / 5 ADC 30 x 10 ³ at 5 AAC, 5 ADC ohm resistive burden
Switching cycles	10 x 10 ⁶ mechanically Diversification according to DIN EN50178 / Characteristics according to DIN EN60255
Power supply	230 VAC ±10 % max. 10 VA 10-30 VDC galv. isolated, max. 4 VA
Memory	
	EEPROM
Data life	≥ 100 years at 25°C
Ambient conditions	
Working temperature	0...50°C
Storing temperature	-20...80°C
Weathering resistance	relative humidity 0-80% on years average without dew
EMV	
	EN 61326
CE-sign	
	Conformity according to directive 2014/30/EU
Safety standard	
	According to low voltage directive 2014/35/EU EN 61010; EN 60664-1

10. Safety advices

Please read the following safety advice and the assembly *chapter 1* before installation and keep it for future reference.

Proper use

The **IM2-12-device** is designed for the evaluation and display of sensor signals.



Danger! Careless use or improper operation can result in personal injury and/or cause damage to the equipment.

Control of the device

The panel meters are checked before dispatch and sent out in perfect condition. Should there be any visible damage, we recommend close examination of the packaging. Please inform the supplier immediately of any damage.



Installation

The **IM2-12-device** must be installed by a suitably **qualified specialist** (e.g. with a qualification in industrial electronics).

Notes on installation

- There must be no magnetic or electric fields in the vicinity of the device, e.g. due to transformers, mobile phones or electrostatic discharge.
- **The fuse rating of the supply voltage should not exceed a value of 0.5A N.B. fuse!**
- Do not install **inductive consumers** (relays, solenoid valves etc.) near the device and **suppress** any interference with the aid of RC spark extinguishing combinations or free-wheeling diodes.
- Keep input, output and supply lines separate from one another and do not lay them parallel with each other. Position "go" and "return lines" next to one another. Where possible use twisted pair. So, you receive best measuring results.
- Screen off and twist sensor lines. Do not lay current-carrying lines in the vicinity. Connect the **screening on one side** on a suitable potential equaliser (normally signal ground).
- The device is not suitable for installation in areas where there is a risk of explosion.
- Any electrical connection deviating from the connection diagram can endanger human life and/or can destroy the equipment.
- The terminal area of the devices is part of the service. Here electrostatic discharge needs to be avoided. Attention! High voltages can cause dangerous body currents.
- Galvanic isolated potentials within one complex need to be placed on an appropriate point (normally earth or machines ground). So, a lower disturbance sensibility against impacted energy can be reached and dangerous potentials, that can occur on long lines or due to faulty wiring, can be avoided.

11. Error elimination

	Error description	Measures
1.	<p>The unit permanently indicates overflow.</p> 	<ul style="list-style-type: none"> The input has a very high measurement, check the measuring circuit. With a selected input with a low voltage signal, it is only connected on one side or the input is open. Not all of the activated setpoints are parameterised. Check if the relevant parameters are adjusted correctly.
2.	<p>The unit permanently shows underflow.</p> 	<ul style="list-style-type: none"> The input has a very low measurement, check the measuring circuit . With a selected input with a low voltage signal, it is only connected on one side or the input is open. Not all of the activated setpoints are parameterised. Check if the relevant parameters are adjusted correctly.
3.	<p>The word HELP lights up in the 7-segment display.</p>	<ul style="list-style-type: none"> The unit has found an error in the configuration memory. Perform a reset on the default values and reconfigure the unit according to your application.
4.	<p>Program numbers for parameterising of the input are not accessible.</p>	<ul style="list-style-type: none"> Programming lock is activated. Enter correct code.
5.	<p>Err1 lights up in the 7-segment display</p>	<ul style="list-style-type: none"> Please contact the manufacturer if errors of this kind occur.
6.	<p>The device does not react as expected.</p>	<ul style="list-style-type: none"> If you are not sure that the device has been parameterised before, then follow the steps as written in <i>chapter 6</i> and set it back to its delivery status.

