

User manual IM3

Alternating voltage / Alternating current signals rms-value (TRMS)

300 VAC, 0-5 AAC



Technical features:

- red display from -19999...99999 digits (optional green, orange, blue or tricolour display)
- installation depth: 120 mm without plug-in screw terminal
- multi voltage power supply unit 100-240 VAC
- adjustment via factory setting or directly on the sensor signal
- min/max-memory with adjustable permanent display
- 30 additional adjustable support points
- display flashing at threshold value exceedance / undercut
- navigation keys for the triggering of Hold, Tara, display change, setpoint setting, alarm actuation
- flexible alarm system with adjustable delay times
- power measurement and energy measurement at constant voltage
- mathematical functions like reciprocal value, square root, square and rounding
- constant setting / setpoint setting
- sliding averaging
- brightness control via parameter or front keys
- programming interlock via access code
- protection class IP65 at the front
- plug-in screw terminal
- optional: 1 or 2 relay outputs
- optional: 1 independently scalable analog output
- accessories: pc-based configuration-kit PM-TOOL with CD & USB adapter
- on demand: devices for working temperatures of -25°C...60°C

Identification

STANDARD TYPES	ORDER NUMBER
Alternating current / Alternating voltage Housing size: 96x24 mm	IM3-3VR5B.0H04.S72xD

Options – breakdown of order code:

	IM	3-	3	V	R	5	B.	0	H	0	4.	S	7	2	x	D		
Standard type M-line																		Dimension [D] physical unit
Installation depth mm 144 mm (154 mm), incl. plug-in terminal			[3]															Version [x] internal version
Housing size B96xH24xD120 mm			[3]															Switching points [0] no switching point [1] 1 relay output [2] 2 relay outputs
Type of display V, A				[V]														Protection class [1] without keypad, operation via PM-Tool [7] IP65 / plug-in terminal
Display colours Blue Green Red Tricolor (red, green, orange) Orange					[B] [G] [R] [T] [Y]													Voltage supply [S] 100-240 VAC
Number of digits 5-digit																		Measuring input [4] AC voltage/AC current, TRMS
Digit height 14 mm																		Analog output [0] without [X] 0-10 VDC, 0/4-20 mA
Digital input without																		Special measuring input [H] 300 VAC, 5 AAC

Please state physical unit by order, e.g. A.

Contents

1.	Brief description	2
2.	Safety advices	2
3.	Assembly	3
4.	Electrical connection	4
5.	Description of function and operation	5
	5.1. Programming software PM-TOOL	6
6.	Setting up the device	7
	6.1. Switching on	7
	6.2. Standard parameterisation (flat operation level)	7
	Value assignment for the triggering of the signal input	
	6.3. Programming interlock „RUN“	10
	Activation/Deactivation of the programming interlock or change into professional or flat operation level	
	6.4. Extended parametersation (professional operation level)	11
	6.4.1. Signal input parameters „INP“	11
	Value assignment for the triggering of the signal input incl. linearisation	
	6.4.2. General device parameters „FCT“	14
	Superior device functions like Hold, Tara, min/max permanent, setpoint value function / nominal value function, averaging, brightness control, suppression of negative Offsets, as well as the control of the keyboard layout	
	6.4.3. Safety parameters „COD“	18
	Assignment of user and master code to lock or to receive access to defined parameter such as analog output and alarms, etc	
	6.4.4. Analog parameters „OUT“	19
	Analog output functions	
	6.4.5. Relay functions „REL“	21
	Parameter for setpoint definition	
	6.4.6. Alarm parameters „AL1...AL4“	22
	Actuator and dependencies of the alarms	
	6.4.7. Totaliser (Volume metering) „TOT“	24
	Parameter for calculation of the sum function	
7.	Reset to factory settings	25
	Reset parameters onto the delivery state	
8.	Alarms / Relays	26
	Functional principle of the switching outputs	
9.	Sensor alignment	27
	Diagram of functional sequences for sensors with existing adjustable resistor	
10.	Technical data	28
11.	Error elimination	30

1. Brief description

The panel meter instrument **IM3-34H** is a 5-digit device for AC current / AC voltage signals (TRMS) and a visual threshold value monitoring via the display. The configuration happens via three keys at the front or by the optional PC software PM-TOOL. The integrated programming interlock prevents unrequested changes of parameters and can be unlocked again with an individual code. Optional the following functions are available: one analog output and interfaces for further evaluating in the unit.

With help of the two galvanic isolated setpoints (optional), free adjustable limit values can be controlled and reported to a superior master display.

The electrical connection is done via plug-in terminals on the back side.

Selectable functions like e.g. the recall of the min/max-value, an averaging of the measuring signals, a nominal presetting or setpoint presetting, a direct threshold value regulation during operation mode and further measuring setpoints for linearisation, complete the modern device concept.

2. Safety advices

Please read the following safety advice and the assembly *chapter 2* before installation and keep it for future reference.

Proper use

The **IM3-34H-device** is designed for the evaluation and display of sensor signals.



Danger! Careless use or improper operation can result in personal injury and/or cause damage to the equipment.

Control of the device

The panel meters are checked before dispatch and sent out in perfect condition. Should there be any visible damage, we recommend close examination of the packaging. Please inform the supplier immediately of any damage.

Installation

The **IM3-34H-device** must be installed by a suitably **qualified specialist** (e.g. with a qualification in industrial electronics).

Notes on installation

- There must be no magnetic or electric fields in the vicinity of the device, e.g. due to transformers, mobile phones or electrostatic discharge.
- **The fuse rating of the supply voltage should not exceed a value of 0.5A N.B. fuse!**
- Do not install **inductive consumers** (relays, solenoid valves etc.) near the device and **suppress** any interference with the aid of RC spark extinguishing combinations or free-wheeling diodes.
- Keep input, output and supply lines separate from one another and do not lay them parallel with each other. Position “go” and “return lines” next to one another. Where possible use twisted pair. So, you receive best measuring results.
- Screen off and twist sensor lines. Do not lay current-carrying lines in the vicinity. Connect the **screening on one side** on a suitable potential equaliser (normally signal ground).
- The device is not suitable for installation in areas where there is a risk of explosion.
- Any electrical connection deviating from the connection diagram can endanger human life and/or can destroy the equipment.
- The terminal area of the devices is part of the service. Here electrostatic discharge needs to be avoided. Attention! High voltages can cause dangerous body currents.
- Galvanic isolated potentials within one complex need to be placed on a appropriate point (normally earth or machines ground). So, a lower disturbance sensibility against impacted energy can be reached and dangerous potentials, that can occur on long lines or due to faulty wiring, can be avoided.

3. Assembly

Please read the *Safety advices* on *page 2* before installation and keep this user manual for future reference.

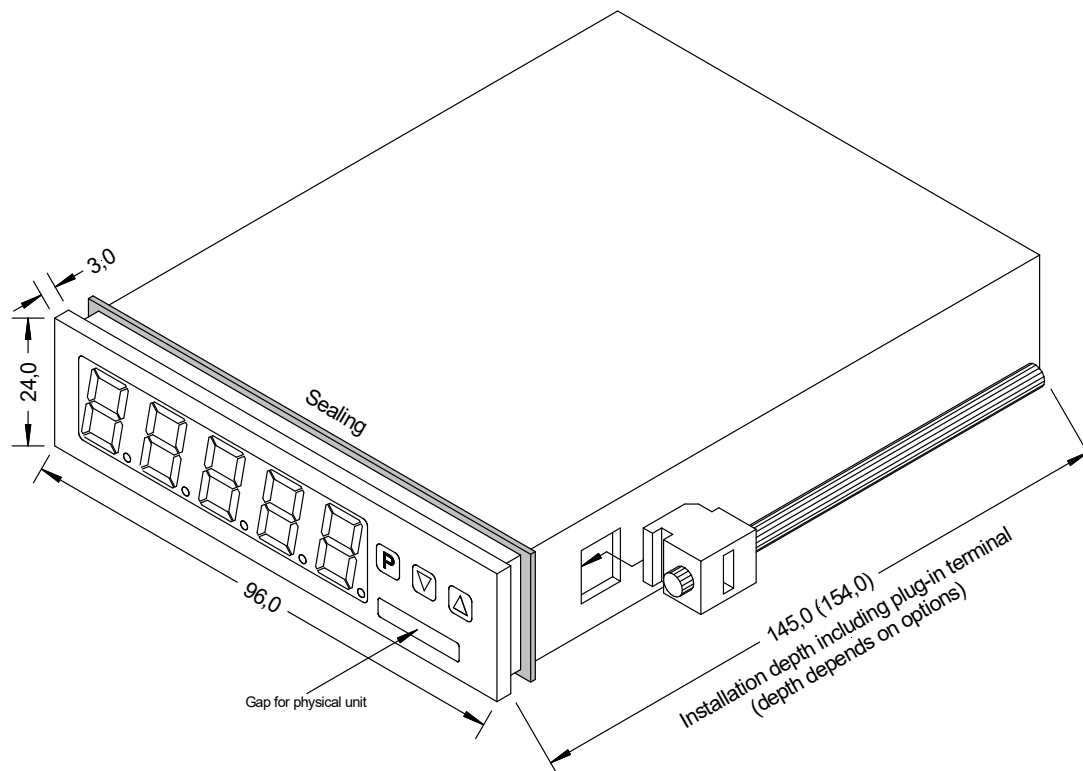

1. After removing the fixing elements, insert the device.
2. Check the seal to make sure it fits securely.
3. Click the fixing elements back into place and tighten the clamping screws by hand. Then use a screwdriver to tighten them another half a turn.

CAUTION! The torque should not exceed 0.1 Nm!

The dimension symbols can be exchanged before installation via a channel on the side!

4. Electrical connection

Type IM3-3VR5B.0H04.S70xD supply 100-240 VAC 50/60Hz, DC $\pm 10\%$

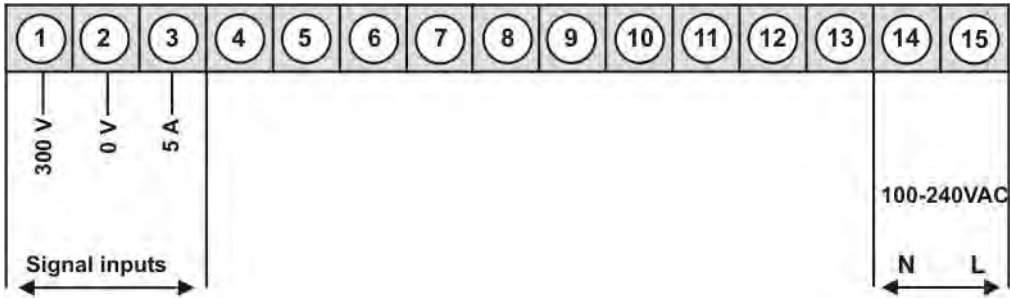

Options:

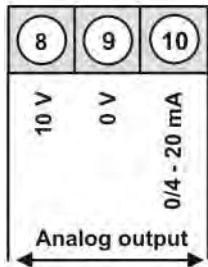
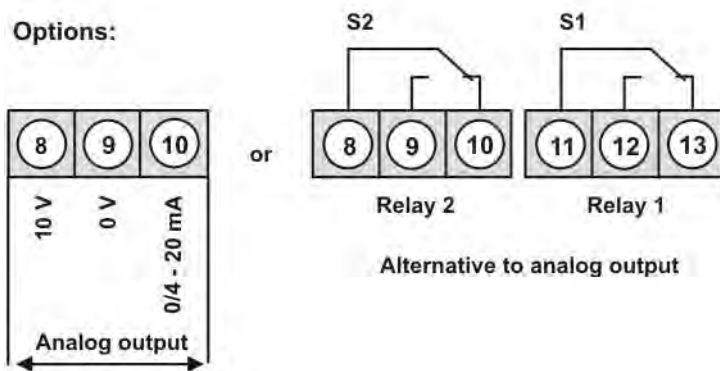

5. Description of function and operation

Operation

The operation is divided into three different levels.

Menu level (delivery status)













This level was designed for the standard settings of the device. Only menu items which are sufficient to set the device into operation are displayed. To get into the professional level, run through the menu level and parameterise *PROF* under menu item *RUN*.

Menu group level (complete function volume)

Suited for complex applications as e.g. linkage of alarms, setpoint treatment, totaliser function etc. In this level function groups which allow an extended parameterisation of the standard settings are available. To leave the menu group level, run through this level and parameterise *ULDC* under menu item *RUN*.

Parameterisation level:

Parameter deposited in the menu item can here be parameterised. Functions, that can be changed or adjusted, are always signalled by a flashing of the display. Settings that are made in the parameterisation level are confirmed with **[P]** and thus safed. Pressing the **[O]-key** leads to a break-off of the value input and to a change into the menu level. All adjustments are saved automatically by the device and changes into operating mode, if no further key operation is done within the next 10 seconds.

Level	Key	Description
Menu-level		Change to parameterisation level and deposited values.
	 	Keys for up and down navigation in the menu level.
		Change into operation mode.
Parameterisation-level		To confirm the changes made at the parameterisation level.
	 	Adjustment of the value / the setting.
		Change into menu level or break-off in value input.
Menu-group-level		Change to menu level.
	 	Keys for up and down navigation in the menu group level.
		Change into operation mode or back into menu level.

Function chart:

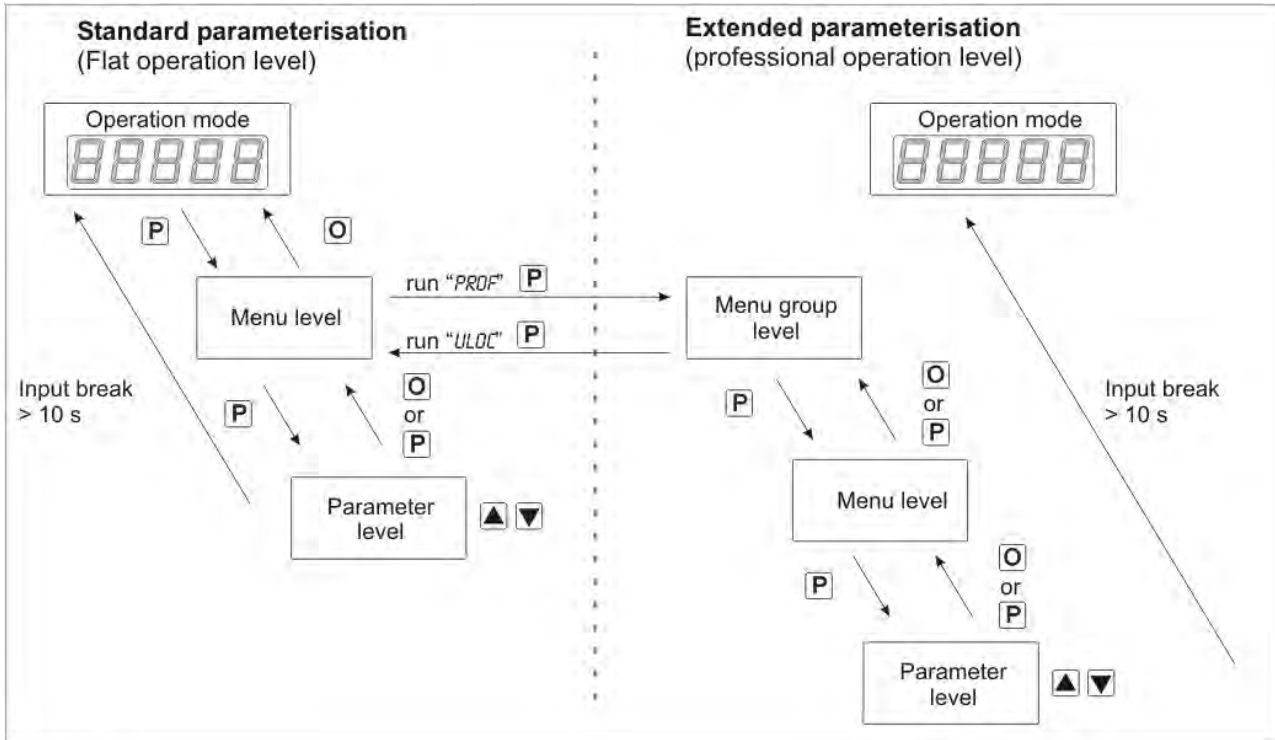

Underline:

- P** Takeover
- O** Stop
- ▲** Value selection (+)
- ▼** Value selection (-)

5.1 Parameterisation software PM-TOOL:

Part of the PM-TOOL are the software on CD and an USB-cable with device adapter. The connection happens via a 4-pole micromatch-plug on the back side of the device, to the PC-side the connection happens via an USB plug.

System requirements: PC incl. USB interface
 Software: Windows XP, Windows VISTA

With this tool the device configuration can be generated, omitted and saved on the PC. The parameters can be changed via the easy to handle program surface, whereat the operating mode and the possible selection options can be preset by the program.

6. Setting up the device

6.1. Switching on

Once the installation is complete, start the device by applying the voltage supply. Before, check once again that all electrical connections are correct.







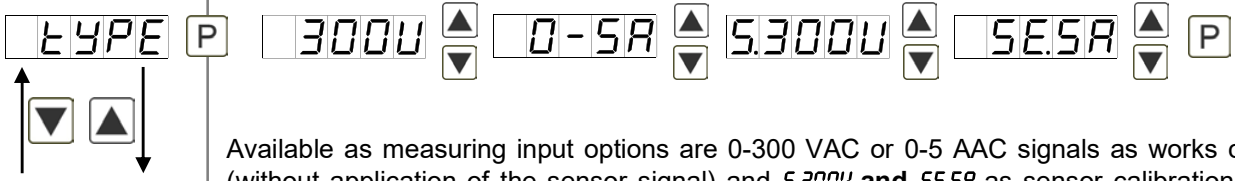
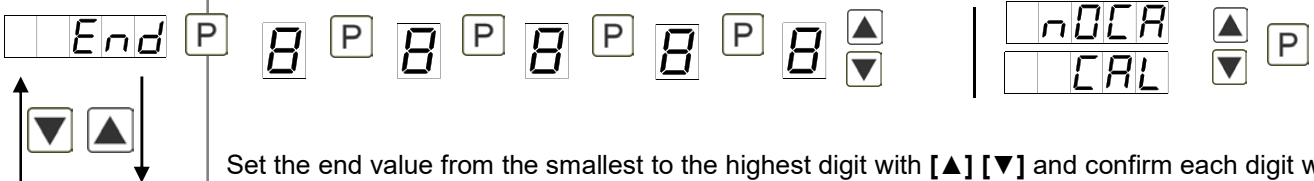
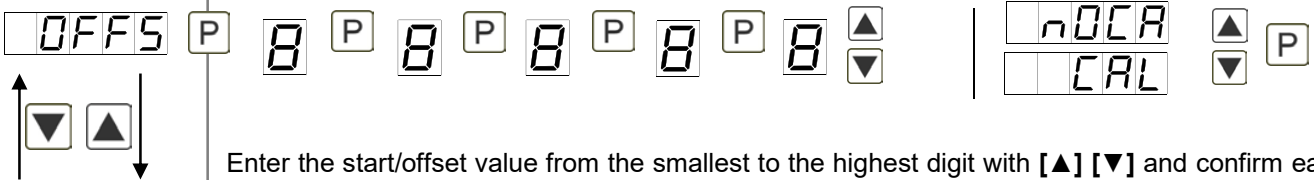

Starting sequence

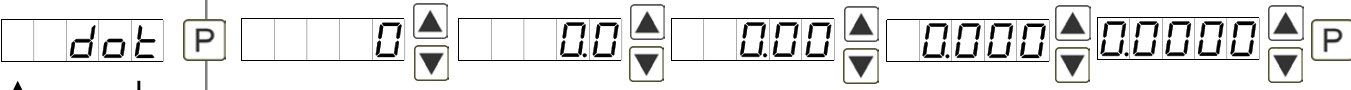

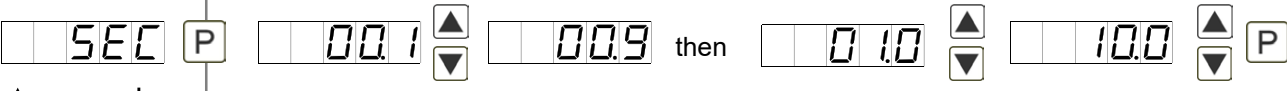
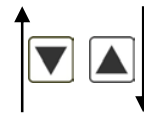
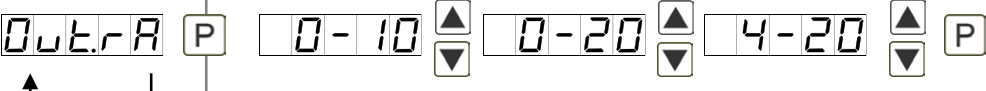
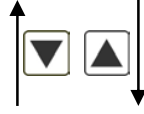

For 1 second during the switching-on process, the segment test (8 8 8 8 8) is displayed followed by an indication of the software type and, after that, also for 1 second the software version. After the starting sequence, the device switches to operation/display mode.

6.2. Standard parameterisation: (Flat operation level)

To parameterise the display, press the **[P]**-key in operating mode for 1 second. The display then changes to the menu level with the first menu item *TYPE*.

Menu level	Parameterisation level
	<p>Selection of the input signal, <i>TYPE</i>: Default: 5.300U</p> <p>Available as measuring input options are 0-300 VAC or 0-5 AAC signals as works calibration (without application of the sensor signal) and 5.300V and 5E.5A as sensor calibration (with the sensor applied). Select with [▲] [▼] and confirm the selection with [P].</p>
	<p>Setting the end value of the measuring range, <i>END</i>: Default: 10000</p> <p>Set the end value from the smallest to the highest digit with [▲] [▼] and confirm each digit with [P]. A minus sign can only be parameterized on the highest value digit. After the last digit, the display switches back to the menu level. If <i>SEMS</i> was selected as input option, you can only select between <i>nDCA</i> and <i>CAL</i>. With <i>nDCA</i>, only the previously set display value is taken over, and with <i>CAL</i>, the device takes over both the display value and the analogue input value.</p>
	<p>Setting the start/offset value of the measuring range, <i>OFFS</i>: Default: 0</p> <p>Enter the start/offset value from the smallest to the highest digit with [▲] [▼] and confirm each digit with [P]. After the last digit the display switches back to the menu level. If <i>SEMS</i> was selected as input option, you can only select between <i>nDCA</i> and <i>CAL</i>. With <i>nDCA</i>, only the previously set display value is taken over, and with <i>CAL</i>, the device takes over both the display value and the analogue input value.</p>

Menu level	Parameterisation level
	<p>Setting the decimal point, DOT: Default: 0</p> <p>  </p> <p>The decimal point on the display can be moved with [▲] [▼] and confirmed with [P]. The display then switches back to the menu level again.</p>
	<p>Setting up the display time, SEC: Default: 1.0</p> <p>  </p> <p>The display time is set with [▲] [▼]. The display moves up in increments of 0.1 up to 1 second and in increments of 1.0 up to 10.0 seconds. Confirm the selection by pressing the [P] button. The display then switches back to the menu level again.</p>
	<p>Selection of analog output, OUT.RA: Default: 4-20</p> <p>  </p> <p>Three output signals are available: 0-10 VDC, 0-20 mA and 4-20 mA, with this function, the demanded signal is selected.</p>
	<p>Setting up the final value of the analog output, OUT.EN: Default: 10000</p> <p>  </p> <p>The final value is adjusted from the smallest digit to the highest digit with [▲] [▼] and digit by digit confirmed with [P]. A minus sign can only be parameterised on the highest digit. After the last digit, the device changes back into menu level.</p>
	<p>Setting up the initial value of the analog output, OUT.OF: Default: 00000</p> <p>  </p> <p>The final value is adjusted from the smallest digit to the highest digit with [▲] [▼] and digit by digit confirmed with [P]. A minus sign can only be parameterised on the highest digit. After the last digit, the device changes back into menu level.</p>
	<p>Threshold values / limits, LI-1: Default: 2000</p> <p>  </p> <p>This value defines the threshold, that activates/deactivates an alarm.</p>

Menu level	Parameterisation level
	<p>Hysteresis for limit values, HY-1: Default: 00000</p> <p>HY-1 P 0 P 0 P 0 P 0 P 0 P</p> <p>The delayed reaction of the alarm is the difference to the threshold value, which is defined by the hysteresis.</p>
	<p>Function for threshold value undercut / exceedance, FU-1: Default: HIGH</p> <p>FU-1 P HIGH LOW P</p> <p>A limit value undercut is selected with <i>LOW</i> (for LOW = lower limit value), a limit value exceedance with <i>HIGH</i> (for HIGH = higher limit value). If e.g. limit value 1 is on a threshold level of 100 and allocated with function <i>HIGH</i>, an alarm is activated by reaching of the threshold level. If the threshold value was allocated to <i>LOW</i>, an alarm will be activated by undercutting the threshold value, as long as the hysteresis is zero.</p>
<p>The same applies to LI-2!</p>	
	<p>User code (4-digit number-combination, free available), U.CODE: Default: 0000</p> <p>U.CoDE P 0 P 0 P 0 P 0 P</p> <p>If this code was set (>0000), all parameters are locked for the user, if <i>LOC</i> has been selected before under menu item <i>RUN</i>. By pressing [P] for 3 seconds in operation mode, the display shows <i>CODE</i>. The <i>U.CODE</i> needs to be entered to get to the reduced number of parameter sets. The code has to be entered before each parameterisation, until the <i>A.CODE</i> (Master code) unlocks all parameters again.</p>
	<p>Master code (4-digit number-combination, free available), A.CODE: Default: 1234</p> <p>A.CoDE P 0 P 0 P 0 P 0 P</p> <p>All parameters can be unlocked with this code, after <i>LOC</i> has been activated under menu item <i>RUN</i>. By pressing [P] for 3 seconds in operation mode, the display shows <i>CODE</i> and enables the user to reach all parameters by entering the <i>A.CODE</i>. Under <i>RUN</i> the parameterisation can be activated permanently by selecting <i>ULOC</i> or <i>PROF</i>, thus at an anew pushing of [P] in operation mode, the code needs not to be entered again.</p>

6.3. Programming interlock „RUN“

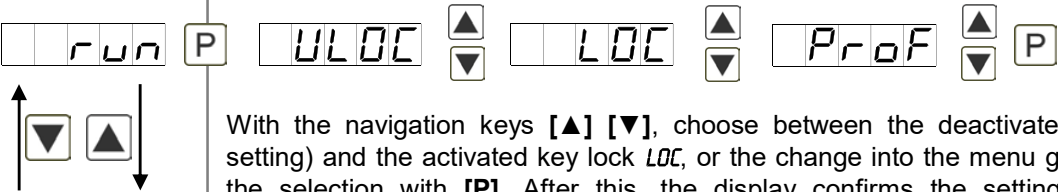





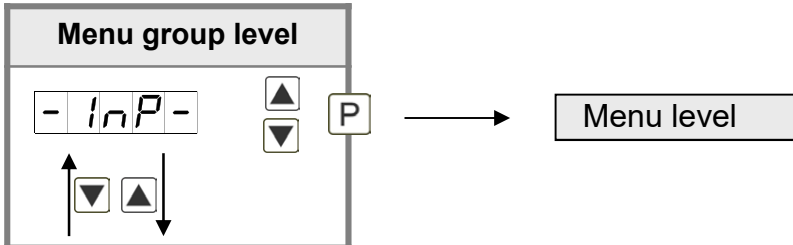

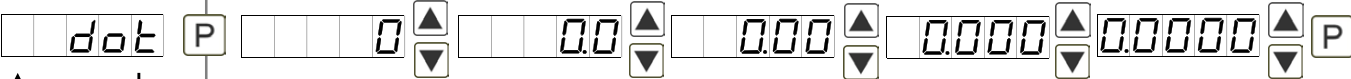

Menu level	Parameterisation level
	<p>Activation / deactivation of the programming lock or completion of the standard parameterisation with change into menu group level (complete function range), <i>RUN</i>: Default: <i>ULOC</i></p> <p>With the navigation keys [▲] [▼], choose between the deactivated key lock <i>ULOC</i> (works setting) and the activated key lock <i>LOC</i>, or the change into the menu group level <i>PROF</i>. Confirm the selection with [P]. After this, the display confirms the settings with "- - - -", and automatically switches to operating mode. If <i>LOC</i> was selected, the keyboard is locked. To get back into the menu level, press [P] for 3 seconds in operating mode. Now enter the <i>CODE</i> (works setting 1 2 3 4) that appears using [▲] [▼] plus [P] to unlock the keyboard. <i>FAIL</i> appears if the input is wrong. To parameterise further functions <i>PROF</i> needs to be set. The device confirms this setting with „- - - -“, and changes automatically in operation mode. By pressing [P] for approx. 3 seconds in operation mode, the first menu group <i>INP</i> is shown in the display and thus confirms the change into the extended parameterisation. It stays activated as long as <i>ULOC</i> or <i>LOC</i> is entered in menu group <i>RUN</i>.</p>

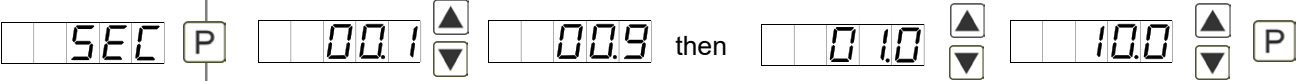







6.4. Extended parameterisation (Professional operation level)

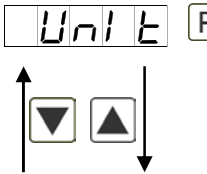
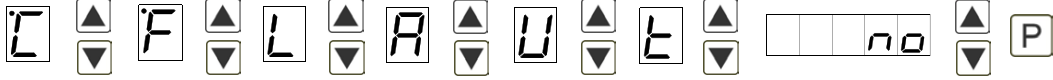
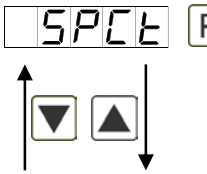

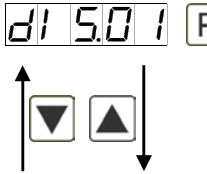
6.4.1. Signal input parameters

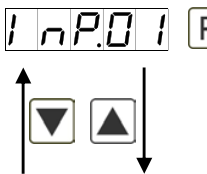

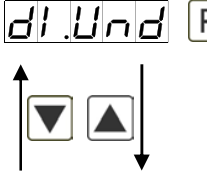
Menu level	Parameterisation level
	<p>Selection of the input signal, <i>TYPE</i>: Default: 5.300V</p> <p>Available as measuring input options are 0-300 VAC or 0-5 AAC signals as works calibration (without application of the sensor signal) and 5.300V and 5E.5A as sensor calibration (with the sensor applied). Select with [▲] [▼] and confirm the selection with [P].</p>
	<p>Setting the end value of the measuring range, <i>END</i>: Default: 10000</p> <p>Set the end value from the smallest to the highest digit with [▲] [▼] and confirm each digit with [P]. A minus sign can only be parameterized on the highest value digit. After the last digit, the display switches back to the menu level. If <i>SENS</i> was selected as input option, you can only select between <i>NOCA</i> and <i>CAL</i>. With <i>NOCA</i>, only the previously set display value is taken over, and with <i>CAL</i>, the device takes over both the display value and the analogue input value.</p>
	<p>Setting up the start/offset value of the measuring range, <i>OFFS</i>: Default: 0</p> <p>Enter the start/offset value from the smallest to the highest digit with [▲] [▼] and confirm each digit with [P]. After the last digit the display switches back to the menu level. If <i>SENS</i> was selected as input option, you can only select between <i>NOCA</i> and <i>CAL</i>. With <i>NOCA</i>, only the previously set display value is taken over, and with <i>CAL</i>, the device takes over both the display value and the analogue input value.</p>

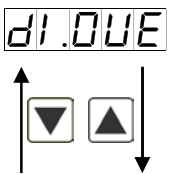

Menu level	Parameterisation level
	<p>Setting the decimal point, DOT: Default: 0</p>  <p>The decimal point on the display can be moved with [▲] [▼] and confirmed with [P]. The display then switches back to the menu level again.</p>
	<p>Setting up the display time, SEC: Default: 1.0</p>  <p>The display time is set with [▲] [▼]. The display moves up in increments of 0.1 up to 1 second and in increments of 1.0 up to 10.0 seconds. Confirm the selection by pressing the [P] button. The display then switches back to the menu level again.</p>
	<p>Rescaling the measuring input values, ENDR: Default: 10000</p>  <p>With this function, you can rescale the input value of e.g. 4.9 AAC (works setting) without applying a measuring signal. If sensor calibration has been selected, these parameters are not available.</p>
	<p>Rescaling the measuring input values, OFFR: Default: 0</p>  <p>With this function, you can rescale the input value of e.g. 0.1 AAC (works setting) without applying a measuring signal. If sensor calibration has been selected, these parameters are not available.</p>
	<p>Setting up the tare/offset value, TARR: Default: 0</p>  <p>The given value is added to the linearized value. In this way, the characteristic line can be shifted by the selected amount.</p>
	<p>Setting up the balance point, ADJ.PT: Default: 08000</p>  <p>The balance point for the final value can be chosen from the measuring range by SE.IOP with 0...10 V or SE.IR with 0...1 A in %. The preset 80.000% result from the widespread detuning of the melt pressure sensors.</p>

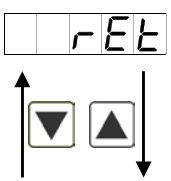

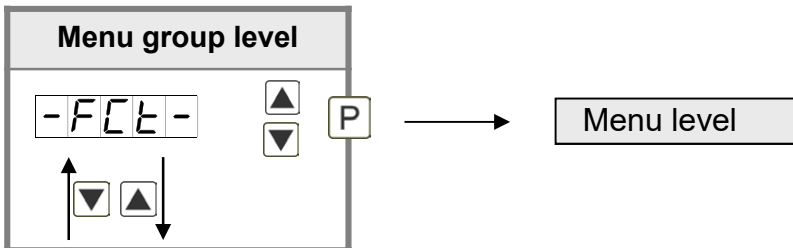

Menu level	Parameterisation level
	<p>Setting up the physical unit, <i>UNIT</i>: Default: <i>NO</i></p>  <p>One can choose between the above shown physical units. It will be displayed on the 5th digit of the display.</p>
	<p>Number of additional setpoints, <i>SPCT</i>: Default: <i>00</i></p>  <p>30 additional setpoints can be defined to the initial value and final value, so linear sensor values are not linearised. Only activated setpoint parameters are displayed.</p>
	<p>Display values for setpoints, <i>DIS.01 ... DIS.30</i>:</p>  <p>Under this parameter setpoints are defined according to their value. At the sensor calibration, like at final value / offset, one is asked at the end if a calibration shall be activated.</p>
	<p>Analog values for setpoints, <i>INP.01 ... INP.30</i>:</p>  <p>The setpoints are always preset according to the selected input signal A/V. The desired analog values can be freely parameterised in ascending order.</p>
	<p>Device undercut, <i>DI.UND</i>: Default: <i>-19999</i></p>  <p>With this function the device undercut (_____) can be defined on a definite value.</p>

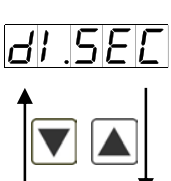
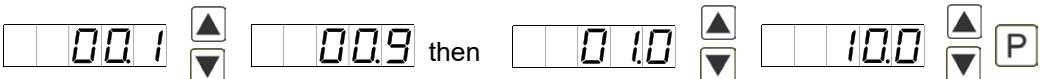
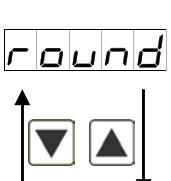





Menu level	Parameterisation level
	<p>Display overflow, <i>DI.OUE</i>: Default: 99999</p>  <p>With this function the display overflow (-----) can be defined on a definite value.</p>
	<p>Back to menu group level, <i>RET</i>:</p> <p>With [P] the selection is confirmed and the device changes into menu group level „-IMP-“.</p>



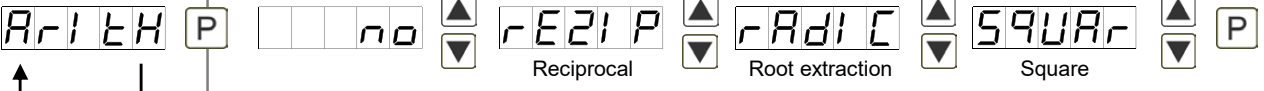







6.4.2. General device parameters





Menu level	Parameterisation level
	<p>Display time, <i>DISEC</i>: Default: 01.0</p>  <p>The display is set up with [▲] [▼]. Thereby it switches up to 1 second in increments of 0.1 seconds and up to 10.0 seconds in increments of 1.0. With [P] the selection is confirmed and the device changes into menu level.</p>
	<p>Rounding of display values, <i>ROUND</i>: Default: 00001</p>  <p>This function is for instable display values, where the display value is changed in increments of 1, 5, 10 or 50. This does not affect the resolution of the optional outputs. With [P] the selection is confirmed and the device changes into menu level.</p>

Menu level	Parameterisation level
	<p>Arithmetic, ARITH: Default: <i>NO</i></p> <p>ArITH P no REZIP Reciprocal rAdiC Root extraction SqUAR Square P</p> <p>With this function the calculated value, not the measuring value, is shown in the display. Calculation types</p> <p>rEZIP = (Final value*Final value)/Display value</p> <p>rAdiC = Root(Display value*Final value)</p> <p>SqUAR = (Display value)²/Final value</p> <p>Advice: The denominator of fractions should not be 0 because a division by 0 is not possible. It creates an undefined state and the display goes into the overflow. With <i>NO</i>, no calculation is deposited. With [P] the selection is confirmed and the device changes into menu level.</p>
	<p>Sliding average determination, AVG: Default: <i>1.0</i></p> <p>AVG P 01 50 P</p> <p>Here, the number of the meterings that need to be averaged is preset. The time of averaging results of the product of measuring time <i>SEC</i> and the averaged metering <i>AVG</i>. With the selection of <i>AVG</i> in the menu level <i>DISPL</i>, the result will be shown in the display and evaluated via the alarms.</p>
	<p>Zero point slowdown, ZERO: Default: <i>00</i></p> <p>ZER0 P 0 P 0 P</p> <p>Here, a value range around the zero point can be preset, so the display shows a zero. If e.g. a 10 is set, the display would show a zero in the value range from -10 to +10; below continue with -11 and beyond with +11. The maximum adjustable range of value is 99.</p>
	<p>Suppression of negative Offsets, N.OFFS: Default: <i>ON</i></p> <p>n.OFFS P ---on ---OFF P</p> <p>This function can be used to suppress negative display values. When ON, the function is active and all measured values below OFFS (measurand of initial value) are ignored, OFF is selected and negative numerical values are displayed, all measured values are linearized. With [P] the selection is confirmed and the display changes to the menu level.</p>
	<p>Definite constant value, CONST: Default: <i>0</i></p> <p>const P 8 P 8 P 8 P 8 P 8 P</p> <p>The constant value can be evaluated via the alarms or via the analog output, like the current measurand. The decimal place cannot be changed for this value and is taken over by the current measurand. Like this a setpoint generator can be realised via the analog output by this value. Furthermore it can be used for calculating the difference. At this the constant value is subtracted from the current measurand and the difference is evaluated in the alerting or by the analog output. Thus regulations can be displayed quite easily.</p>

Menu level	Parameterisation level
	<p>Arithmetic, ARITH: Default: <i>NO</i></p> <p>  </p> <p>With this function the calculated value, not the measuring value, is shown in the display. Calculation types</p> <p>rEZIP = (Final value*Final value)/Display value</p> <p>rAdiC = Root(Display value*Final value)</p> <p>SqUAr = (Display value)²/Final value</p> <p>Advice: The denominator of fractions should not be 0 because a division by 0 is not possible. It creates an undefined state and the display goes into the overflow. With <i>NO</i>, no calculation is deposited. With [P] the selection is confirmed and the device changes into menu level.</p>
	<p>Sliding average determination, AVG: Default: <i>1.0</i></p> <p>  </p> <p>Here, the number of the meterings that need to be averaged is preset. The time of averaging results of the product of measuring time <i>SEC</i> and the averaged metering <i>AVG</i>. With the selection of <i>AVG</i> in the menu level <i>DISPL</i>, the result will be shown in the display and evaluated via the alarms.</p>
	<p>Zero point slowdown, ZERO: Default: <i>00</i></p> <p>  </p> <p>At the zero point slowdown, a value range around the zero point can be preset, so the display shows a zero. If e.g. a 10 is set, the display would show a zero in the value range from -10 to +10; below continue with -11 and beyond with +11. The maximum adjustable range of value is 99.</p>
	<p>Definite constant value, CONST: Default: <i>0</i></p> <p>  </p> <p>The constant value can be evaluated via the alarms or via the analog output, like the current measurand. The decimal place cannot be changed for this value and is taken over by the current measurand. Like this a setpoint generator can be realised via the analog output by this value. Furthermore it can be used for calculating the difference. At this the constant value is subtracted from the current measurand and the difference is evaluated in the alerting or by the analog output. Thus regulations can be displayed quite easily.</p>

Menu level	Parameterisation level
	<p>Minimum constant value, <i>CON.MI</i>: Default: -19999</p> <p>  </p> <p>The minimum constant value is adjusted from the smallest to the highest digit with the navigation keys [▲] [▼] and confirmed digit per digit with [P]. A minus sign can only be adjusted on the highest digit. After the last digit the display changes back into menu level.</p>
	<p>Maximum constant value, <i>CON.MA</i>: Default: 99999</p> <p>  </p> <p>The maximum constant value is adjusted from the smallest to the highest digit with the navigation keys [▲] [▼] and confirmed digit per digit with [P]. A minus sign can only be adjusted on the highest digit. After the last digit the display changes back into menu level.</p>
	<p>Display, <i>DISPL</i>: Default: <i>ACTUA</i></p> <p>  </p> <p>With this function the current measuring value, min/max value, totaliser value or the process-controlled Hold-value can be allocated to the display. With [P] the selection is confirmed and the device changes into menu level.</p>
	<p>Brightness control, <i>LIGHT</i>: Default: 10</p> <p>  </p> <p>The brightness of the display can be adjusted in 16 levels from 00 = very dark to 15 = very bright via this parameter or alternatively via the navigation keys from the outside. During the start of the device the level that is deposited under this parameter will always be used, even though the brightness has been changed via the navigation keys in the meantime.</p>
	<p>Display flashing, <i>FLASH</i>: Default: <i>NO</i></p> <p>  </p> <p>A display flashing can be added as additional alarm function either to single or to a combination of off-limit condition. With <i>NO</i>, no flashing is allocated.</p>

Menu level	Parameterisation level																																
<div style="display: flex; align-items: center;"> <div style="border: 1px solid black; padding: 2px; margin-right: 5px;">EASE</div> <div style="border: 1px solid black; padding: 2px; margin-right: 5px;">P</div> <div style="margin-right: 10px;">  </div> </div>	<p>Assignment (deposit) of key functions, TAST: Default: <i>NO</i></p> <table style="width: 100%; border-collapse: collapse;"> <tr> <td style="border: 1px solid black; padding: 2px; text-align: center;">EHTR</td> <td style="text-align: center;">▲ ▼</td> <td style="border: 1px solid black; padding: 2px; text-align: center;">L1.12</td> <td style="text-align: center;">▲ ▼</td> <td style="border: 1px solid black; padding: 2px; text-align: center;">L1.34</td> <td style="text-align: center;">▲ ▼</td> <td style="border: 1px solid black; padding: 2px; text-align: center;">TARA</td> <td style="text-align: center;">▲ ▼</td> </tr> <tr> <td style="border: 1px solid black; padding: 2px; text-align: center;">SET.TA</td> <td style="text-align: center;">▲ ▼</td> <td style="border: 1px solid black; padding: 2px; text-align: center;">TOTAL</td> <td style="text-align: center;">▲ ▼</td> <td style="border: 1px solid black; padding: 2px; text-align: center;">TOT.RE</td> <td style="text-align: center;">▲ ▼</td> <td style="border: 1px solid black; padding: 2px; text-align: center;">EHT.RE</td> <td style="text-align: center;">▲ ▼</td> </tr> <tr> <td style="border: 1px solid black; padding: 2px; text-align: center;">ACTUA</td> <td style="text-align: center;">▲ ▼</td> <td style="border: 1px solid black; padding: 2px; text-align: center;">LIGHT</td> <td style="text-align: center;">▲ ▼</td> <td style="border: 1px solid black; padding: 2px; text-align: center;">L1.1</td> <td style="text-align: center;">▲ ▼</td> <td style="border: 1px solid black; padding: 2px; text-align: center;">L1.1-2</td> <td style="text-align: center;">▲ ▼</td> </tr> <tr> <td style="border: 1px solid black; padding: 2px; text-align: center;">L1.1-3</td> <td style="text-align: center;">▲ ▼</td> <td style="border: 1px solid black; padding: 2px; text-align: center;">L1.1-4</td> <td style="text-align: center;">▲ ▼</td> <td style="border: 1px solid black; padding: 2px; text-align: center;">no</td> <td style="text-align: center;">▲ ▼</td> <td style="border: 1px solid black; padding: 2px; text-align: center;">P</td> <td></td> </tr> </table> <p>For the operation mode, special functions can be deposited on the navigation keys [▲] [▼], in particular this function is made for devices in housing size 48x24mm which do not have a 4th key ([O]-key). If the min/max-memory is activated with <i>EHTR</i>, all measured min/max-values are saved during operation and can be recalled via the navigation keys. The values get lost by restart of the device. If the threshold value correction <i>L1.12</i> or <i>L1.34</i> is chosen, the values of the threshold can be changed during operation without disturbing the operating procedure. With <i>TARA</i> the device is tared to zero and saved permanently as offset. The device confirms the correct taring by showing <i>00000</i> in the display. <i>SET.TA</i> switches into the offset value and can be changed via the navigation keys [▲] [▼]. Via <i>TOTAL</i> the current value of the totaliser can be displayed, after this the device changes back on the parameterised display value. If <i>TOT.RE</i> is deposited, the totaliser can be set back by pressing of the navigation keys [▲] [▼], the device acknowledges this with <i>00000</i> in the display. The configuration of <i>EHT.RE</i> deletes the min/max-memory. Under <i>ACTUA</i> the measurand is shown, after this the display returns to the parameterised display value. If <i>ABS.UA</i> (absolute value) was selected, the display shows the value that has been measured since voltage connection, without consideration of a previous taring. Via selection <i>L1.1</i>, <i>L1.1-2</i>, <i>L1.1-3</i>, <i>L1.1-4</i> threshold values can be addressed via the navigation keys; they can be changed digit per digit or taken over by pushing the [P]-key. The adjustment is taken over directly, an existing limit value monitoring and the current measurement will not be influenced by this. If <i>NO</i> is selected, the navigation keys are without any function in the operation mode.</p>	EHTR	▲ ▼	L1.12	▲ ▼	L1.34	▲ ▼	TARA	▲ ▼	SET.TA	▲ ▼	TOTAL	▲ ▼	TOT.RE	▲ ▼	EHT.RE	▲ ▼	ACTUA	▲ ▼	LIGHT	▲ ▼	L1.1	▲ ▼	L1.1-2	▲ ▼	L1.1-3	▲ ▼	L1.1-4	▲ ▼	no	▲ ▼	P	
EHTR	▲ ▼	L1.12	▲ ▼	L1.34	▲ ▼	TARA	▲ ▼																										
SET.TA	▲ ▼	TOTAL	▲ ▼	TOT.RE	▲ ▼	EHT.RE	▲ ▼																										
ACTUA	▲ ▼	LIGHT	▲ ▼	L1.1	▲ ▼	L1.1-2	▲ ▼																										
L1.1-3	▲ ▼	L1.1-4	▲ ▼	no	▲ ▼	P																											
<div style="display: flex; align-items: center;"> <div style="border: 1px solid black; padding: 2px; margin-right: 5px;">rEt</div> <div style="margin-right: 10px;">  </div> </div>	<p>Back to menu group level, RET:</p> <p>With [P] the selection is confirmed and the device changes into menu group level „-FCT-“.</p>																																

6.4.3. Safety parameters

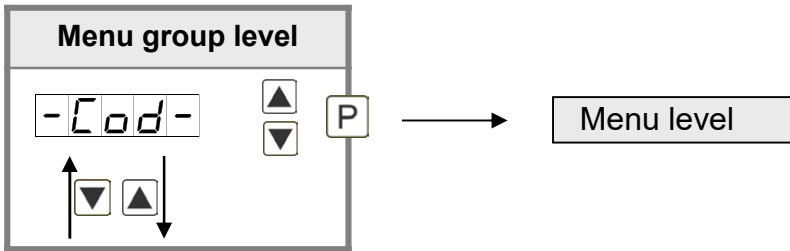



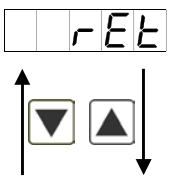

Menu level	Parameterisation level
	<p>User code <i>U.CODE</i>: Default: 0000</p> <p><i>U.CoDE</i> P 0 P 0 P 0 P 0 P</p> <p>Via this code reduced sets of parameters can be set free. A change of the <i>U.CODE</i> can be done via the correct input of the <i>R.CODE</i> (master code).</p>
	<p>Master code, <i>R.CODE</i>: Default: 1234</p> <p><i>R.CoDE</i> P 1 P 2 P 3 P 4 P</p> <p>By entering <i>R.CODE</i> the device will be unlocked and all parameters are released.</p>
	<p>Release/lock analog output parameter, <i>OUT.LE</i>: Default: <i>ALL</i></p> <p><i>Out.LE</i> P <i>no</i> <i>En-Of</i> <i>Out.EO</i> <i>ALL</i> P</p> <p>Analog output parameter can be locked or released for the user:</p> <ul style="list-style-type: none"> - <i>EN-OF</i>: the initial or final value can be changed in operation mode - <i>OUT.EO</i>: the output signal can be changed from e.g. 0-20 mA to 4-20 mA or 0-10 VDC - <i>ALL</i>: analog output parameters are released - <i>NO</i>: all analog output parameters are locked
	<p>Release/lock alarm parameters, <i>AL.LEU</i>: Default: <i>ALL</i></p> <p><i>AL.LEU</i> P <i>no</i> <i>LIMIT</i> <i>ALrNL</i> <i>ALL</i> P</p> <p>This parameter describes the user release/user lock of the alarm:</p> <ul style="list-style-type: none"> - <i>LIMIT</i>: here only the range of value of the threshold values 1-4 can be changed - <i>ALRM.L</i>: here the range of value and the alarm trigger can be changed - <i>ALL</i>: all alarm parameters are released - <i>NO</i>: all alarm parameters are locked

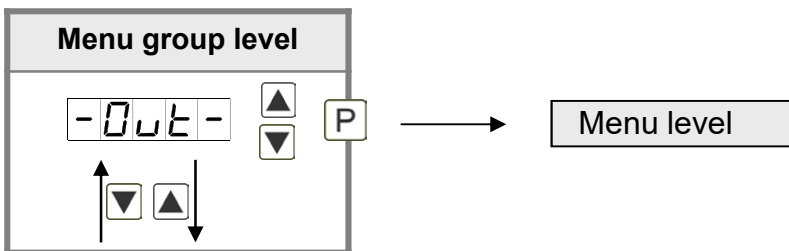
Menu level	Parameterisation level
	<p>Back to menu group level, <i>RET</i>:</p> <p>With [P] the selection is confirmed and the device changes into menu group level „-COD-“.</p>

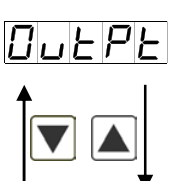
6.4.4. Analog output parameters

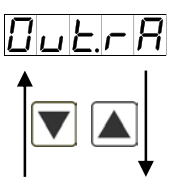
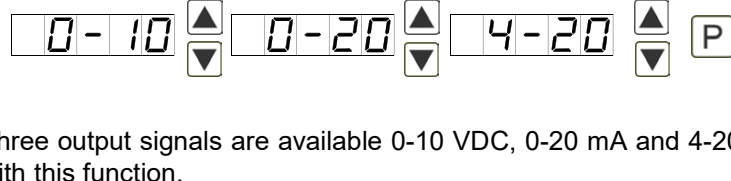
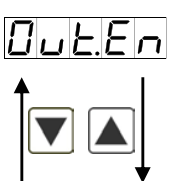
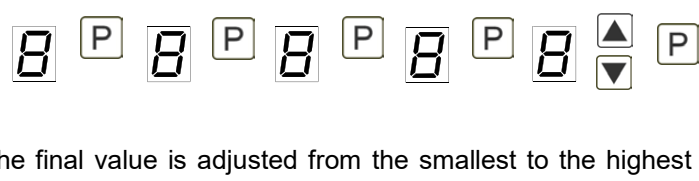

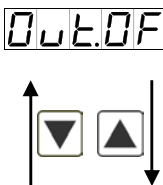

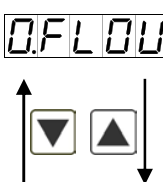
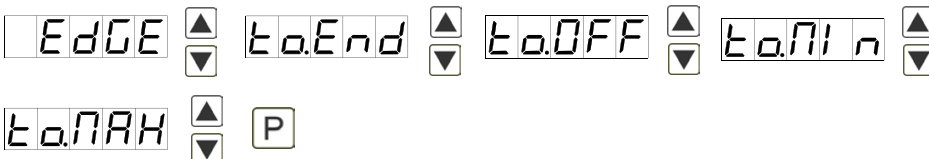
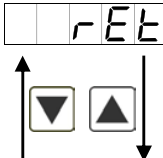
Menu level	Parameterisation level
	<p>Selection reference of analog output, <i>OUTPT</i>: Default: <i>ACTUA</i></p> <p>  </p> <p>The analog output signal can refer to different functions, in detail these are the current measurand, the min-value, the max-value, the totaliser function / sum function, the constant value or the difference between current measurand and constant value. If <i>HOLD</i> is selected, the signal of the analog output will be kept. It can be continued processing after a deactivation of <i>HOLD</i>. With [P] the selection is confirmed and the device changes into menu level.</p>
	<p>Selection analog output, <i>OUT.RA</i>: Default: 4-20</p> <p>  </p> <p>Three output signals are available 0-10 VDC, 0-20 mA and 4-20 mA. Select the desired signal with this function.</p>
	<p>Setting the final value of the analog output, <i>OUT.EN</i>: Default: 10000</p> <p>  </p> <p>The final value is adjusted from the smallest to the highest digit with [▲] [▼] and confirmed digit per digit with [P]. A minus sign can only be parameterised on the highest digit. After the last digit the device changes back into menu level.</p>

Menu level	Parameterisation level
	<p>Setting the initial value of the analog output, <i>OUT.OF</i>: Default: 00000</p> <p></p> <p>The initial value is adjusted from the smallest to the highest digit with [▲] [▼] and confirmed digit per digit with [P]. A minus sign can only be parameterised on the highest digit. After the last digit the device changes back into menu level.</p>
	<p>Overflow behaviour, <i>O.FLOW</i>: Default: <i>EDGE</i></p> <p></p> <p>To recognise and evaluate faulty signals, e.g. by a controller, the overflow behaviour of the analog output can be defined. As overflow can be seen either <i>EDGE</i>, that means the analog output runs on the set limits e.g. 4 and 20 mA, or <i>TO.OFF</i> (input value smaller than initial value, analog output switches on e.g. 4 mA), <i>TO.END</i> (higher than final value, analog output switches on e.g. 20 mA). If <i>TO.MIN</i> or <i>TO.MAX</i> is set, the analog output switches on the smallest or highest possible binary value. This means that values of e.g. 0 mA, 0 VDC or values higher than 20 mA or 10 VDC can be reached. With [P] the selection is confirmed and the device changes into menu level.</p>
	<p>Back to menu group level, <i>RET</i>:</p> <p>With [P] the selection is confirmed and the device changes into menu group level „-OUT-“.</p>

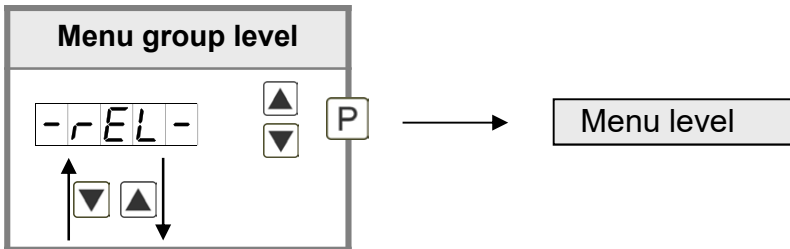
6.4.5. Relay functions





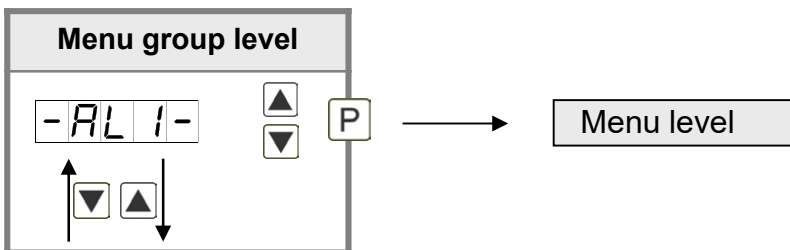

Menu level	Parameterisation level												
	<p>Alarm relay 1, REL-1: The same applies for relay 2 Default: <i>AL-1</i></p> <p>REL-1 P AL-1 AL-4 ▲▼ AL-n1 AL-n4 ▲▼</p> <p>LOGIC ▲▼ OFF ▲▼ On ▲▼ CAL ▲▼</p> <p>CAL.OF ▲▼ CAL.EN ▲▼ P</p> <p>Each setpoint (optional) can be linked up via 4 alarms (by default). This can either be inserted at activated alarms <i>AL1/4</i> or deactivated alarms <i>ALN1/4</i>. If <i>LOGIC</i> is selected, logical links are available in the menu level <i>LOG-1</i> and <i>COM-1</i>. Access to these two menu levels is via <i>LOGIC</i>, at all other selected functions, these two parameters are overleaped. Via <i>ON/OFF</i> the setpoints can be activated/deactivated, in this case the output and the setpoint display are set/not set on the front of the device. The parameters <i>CAL</i>, <i>CAL.OF</i> and <i>CAL.EN</i> can only be used in accordance with the semi-automatic calibration (<i>Chapter 9. Sensor alignment</i>). At <i>CAL</i> the relay switches during sensor calibration, at <i>CAL.OF</i> during offset calibration and at <i>CAL.EN</i> during the calibration of the final value. With [P] the selection is confirmed and the device changes into menu level.</p>												
	<p>Logic relay 1, LOG-1 Default: <i>OR</i></p> <p>LOG-1 P or ▲▼ nor ▲▼ And ▲▼ nAnd ▲▼ P</p> <p>Here, the switching behaviour of the relay is defined via a logic link, the following schema describes these functions with inclusion of <i>AL-1</i> and <i>AL-2</i>. This parameter can only be selected if <i>LOGIC</i> was selected under <i>REL-1</i>.</p> <table border="1"> <tbody> <tr> <td>or</td> <td>$A1 \vee A2$</td> <td>As soon as a selected alarm is activated, the relay operates. Equates to operating current principle.</td> </tr> <tr> <td>nor</td> <td>$\overline{A1 \vee A2} = \overline{A1} \wedge \overline{A2}$</td> <td>The relay operates only, if no selected alarm is active. Equates to quiescent current principle.</td> </tr> <tr> <td>And</td> <td>$A1 \wedge A2$</td> <td>The relay operates only, if all selected alarms are active.</td> </tr> <tr> <td>nAnd</td> <td>$\overline{A1 \wedge A2} = \overline{A1} \vee \overline{A2}$</td> <td>As soon as a selected alarm is not activated, the relay operates.</td> </tr> </tbody> </table> <p>With [P] the selection is confirmed and the device changes into menu level.</p>	or	$A1 \vee A2$	As soon as a selected alarm is activated, the relay operates. Equates to operating current principle.	nor	$\overline{A1 \vee A2} = \overline{A1} \wedge \overline{A2}$	The relay operates only, if no selected alarm is active. Equates to quiescent current principle.	And	$A1 \wedge A2$	The relay operates only, if all selected alarms are active.	nAnd	$\overline{A1 \wedge A2} = \overline{A1} \vee \overline{A2}$	As soon as a selected alarm is not activated, the relay operates.
or	$A1 \vee A2$	As soon as a selected alarm is activated, the relay operates. Equates to operating current principle.											
nor	$\overline{A1 \vee A2} = \overline{A1} \wedge \overline{A2}$	The relay operates only, if no selected alarm is active. Equates to quiescent current principle.											
And	$A1 \wedge A2$	The relay operates only, if all selected alarms are active.											
nAnd	$\overline{A1 \wedge A2} = \overline{A1} \vee \overline{A2}$	As soon as a selected alarm is not activated, the relay operates.											

Menu level	Parameterisation level
	<p>Alarms for relay 1, COM-1: Default: <i>R.1</i></p> <p>COM-1 P R.1 R.2 ... R.1234 P</p> <p>The allocation of the alarms to relay 1 happens via this parameter, one alarm or a group of alarms can be chosen. With [P] the selection is confirmed and the device changes into menu level.</p>
	<p>Back to menu group level, RET:</p> <p>RET</p> <p>With [P] the selection is confirmed and the device changes into menu group level „-REL-“.</p>

6.4.6. Alarm parameters

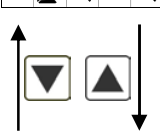
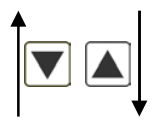
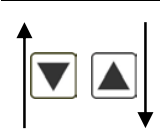

Menu level	Parameterisation level
	<p>Dependency alarm 1, ALRM.1: Default: <i>ACTUA</i></p> <p>ALRM.1 P ActUA MinUA MaxUA totAL HoLD AUG conSt dIFF EXtEr P</p> <p>The dependency of alarm 1 can be related to special functions, in detail these are the current measurand, the min-value, the max-value, the totaliser value/sum value, the sliding average value, the constant value or the difference between the current measurand and the constant value. If <i>HOLD</i> is selected the alarm is hold and processed just after deactivation of <i>HOLD</i>. <i>EXtEr</i> causes the dependency by an external signal via the digital input. With [P] the selection is confirmed and the device changes into menu level.</p> <p>Example: By using the maximum value <i>ALARM.1 = MAX.VA</i> in combination with a threshold monitoring <i>FU-1 = HIGH</i>, an alarm confirmation can be realised. Use the navigation keys or the digital input for confirmation.</p>

Menu level	Parameterisation level
	<p>Threshold values / limit values, LI-1: Default: 2000</p> <p>LI-1 P 0 P 0 P 0 P 0 P 0 P</p> <p>The limit value defines the threshold, that activates/deactivates an alarm.</p>
	<p>Hysteresis for threshold values, HY-1: Default: 00000</p> <p>HY-1 P 0 P 0 P 0 P 0 P 0 P</p> <p>The delayed reaction of the alarm is the difference to the threshold value, which is defined by the hysteresis.</p>
	<p>Function for threshold value undercut / exceedance, FU-1: Default: HIGH</p> <p>FU-1 P HIGH LOW P</p> <p>A limit value undercut is selected with <i>LOW</i> (for LOW = lower limit value), a limit value exceedance with <i>HIGH</i> (for HIGH = higher limit value). If e.g. limit value 1 is on a threshold level of 100 and allocated with function <i>HIGH</i>, an alarm is activated by reaching of the threshold level. If the threshold value was allocated to <i>LOW</i>, an alarm will be activated by undercutting the threshold value, as long as the hysteresis is zero.</p>
	<p>Switching-on delay, TON-1: Default: 000</p> <p>TON-1 P 0 P 0 P 0 P</p> <p>For limit value 1 one can preset a delayed switching-on of 0-100 seconds.</p>
	<p>Switching-off delay, TOF-1: Default: 000</p> <p>TOF-1 P 0 P 0 P 0 P</p> <p>For limit value 1 one can preset a delayed switching-off of 0-100 seconds.</p>
	<p>Back to menu group level, RET:</p> <p>RET</p> <p>With [P] the selection is confirmed and the device changes into menu group level „-RL1-“.</p>

The same applies for *RL2* to *RL8*.

6.4.7. Totaliser (Volume metering)

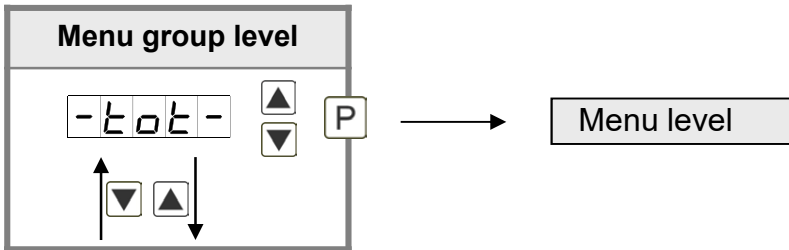

Menu level	Parameterisation level
	<p>State of totaliser, TOTAL: Default: OFF</p> <p>total P OFF STEAD TEMP P</p> <p>The totaliser realizes measurements on a time base of e.g. l/h, at this the scaled input signal is integrated by time and steadily (select <i>STEAD</i>) or temporarily (select <i>TEMP</i>) saved. Select the constant storage for consumption measurements and the quick storage for frequently filling processes. During the constant storage <i>STEAD</i> the current sum value is saved at each totaliser reset. Furthermore it is safed every 30 minutes in the not-quick storage of the device. If <i>OFF</i> is selected, the function is deactivated. With [P] the selection is confirmed and the device changes into menu level.</p>
	<p>Time base, T.BASE: Default: SEC</p> <p>TBASE P SEC min hour P</p> <p>Under this parameter the time base of the measurement can be preset in seconds, minutes or hours.</p>
	<p>Totaliser factor, FACTO: Default: 1E0</p> <p>FACTO P 1E0 ... 1E6 P</p> <p>At this the factor (1E0...1E6) respectively the divisor for the internal calculation of the measuring value is assigned.</p>
	<p>Setting up the decimal point for the totaliser, TOT.DT: Default: 0</p> <p>tot.dt P 0 0.0 0.00 0.000 0.0000</p> <p>000000 P</p> <p>The decimal point of the device can be adjusted with the navigation keys [▲] [▼]. With [P] the selection is confirmed and the device changes into menu level.</p>

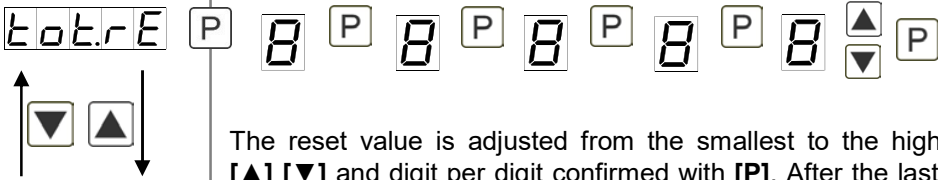
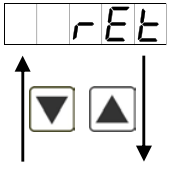
Menu level	Parameterisation level
	<p>Totaliser reset, TOT.RE: Default: 00000</p> <p>The reset value is adjusted from the smallest to the highest digit with the navigation keys [▲] [▼] and digit per digit confirmed with [P]. After the last digit, the display switches back to the menu level. The activator for the reset is parameter driven via the 4th key or via the optional digital input.</p>
	<p>Back to menu group level, RET:</p> <p>With [P] the selection is confirmed and the device changes into menu group level „-TOT-“.</p>

Programming interlock, RUN:

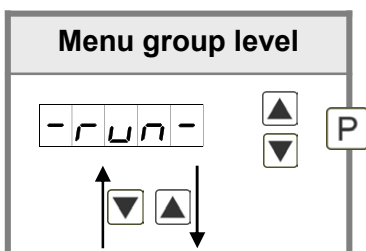

Description see page 10, menu level RUN

7. Reset to default values

To return the unit to a **defined basic state**, a reset can be carried out to the default values.

The following procedure should be used:

- Switch off the power supply
- Press button [P]
- Switch on voltage supply and press [P]-button until „- - - -“ is shown in the display.

With reset, the default values of the program table are loaded and used for subsequent operation. This sets the unit back to the state in which it was supplied.

Caution! All application-related data are lost.

8. Alarms / Relays

This device has 8 virtual alarms that can monitor one limit value in regard of an undercut or exceedance. Each alarm can be allocated to an optional relay output S1-S2; furthermore alarms can be controlled by events like e.g. hold value or min/max-value.

Function principle of alarms / relays	
Alarm / Relay x	deactivated, instantaneous value, min/max-value, hold-value, totaliser value, sliding average value, constant value, difference between instantaneous value and constant value or an activation via the digital input
Switching threshold	Threshold / limit value of the change-over
Hysteresis	Broadness of the window between the switching thresholds
Working principle	Operating current / quiescent current

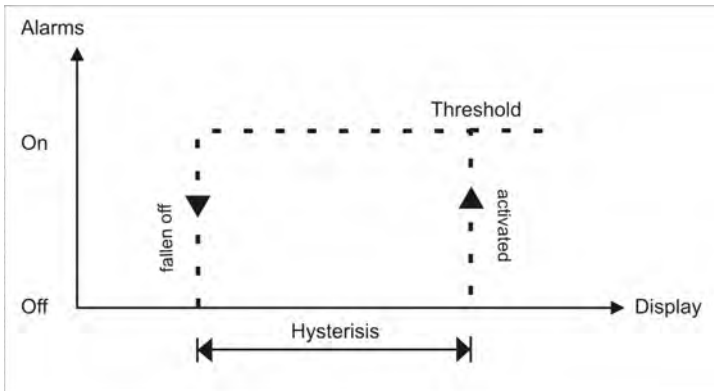

Operating current

By operating current the alarm S1-S2 is **off** below the threshold and **on** on reaching the threshold.

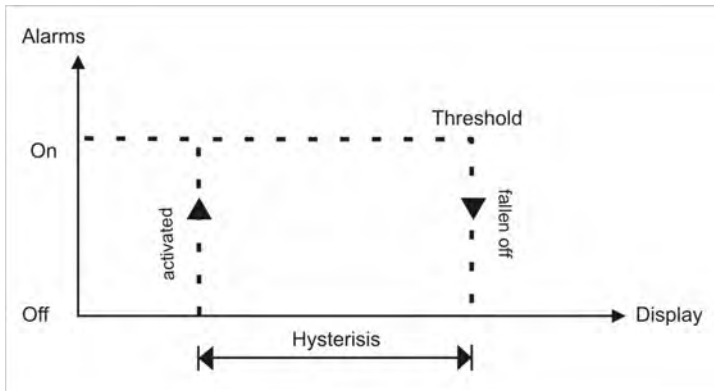

Quiescent current

By quiescent current the alarm S1-S2 is **on** below the threshold and switched **off** on reaching the threshold.

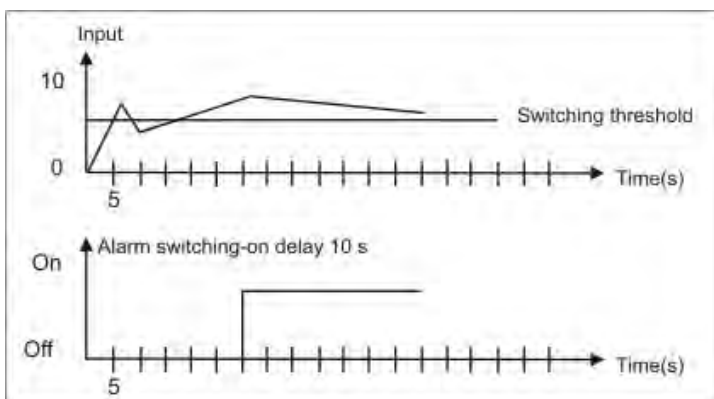

Switching-on delay

The switching-on delay is activated via an alarm and e.g. switched 10 seconds after reaching the switching threshold, a short-term exceedance of the switching value does not cause an alarm, respectively does not cause a switching operation of the relay. The switching-off delay operates in the same way, keeps the alarm / the relay switched longer for the parameterised time.

9. Sensor alignment offset / final value

The device is equipped with a semi-automatic sensor calibration (5.300V, 5E.5A). A switching output operates the trimming resistor, which exists in some sensors. An adjustment of offset and final value takes place, after which the sensor can be used directly. Depending on parameterisation, the calibration can be realized via the 4th key or via the digital input. It is possible to key during the calibration steps. So, reference signals can be connected manually. However the calibration will be interrupted after 30 seconds.

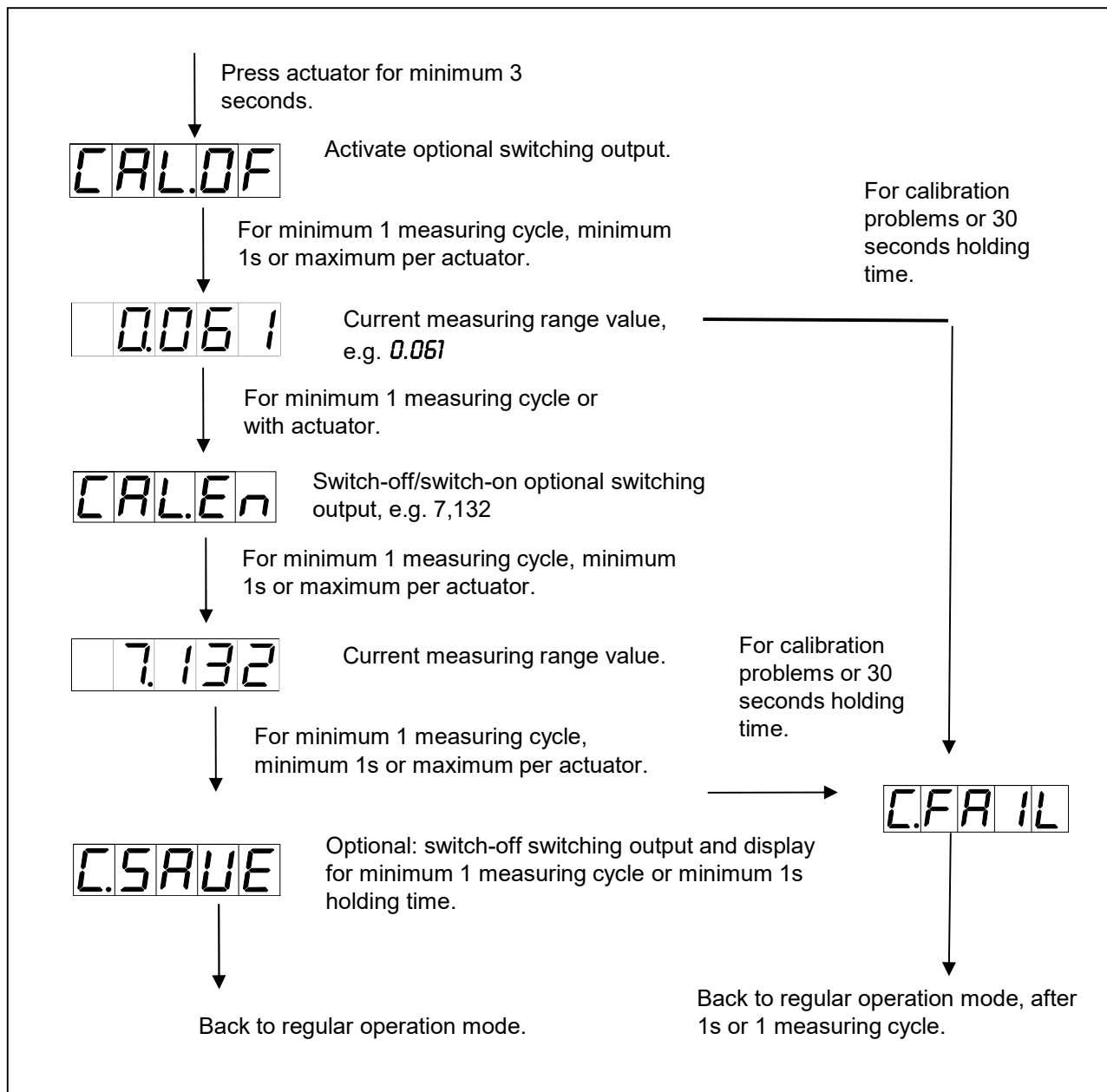



10. Technical data

Housing			
Dimensions	96x24x120 mm (BxHxD)		
	96x24x144 (154) mm (BxHxD) incl. plug-in terminal		
Panel cut-out	92.0 ^{+0.8} x 22.2 ^{+0.3} mm		
Wall thickness	up to 10 mm		
Fixing	screw elements		
Material	PC polycarbonate, black, UL94V-0		
Sealing material	EPDM, 65 Shore, black		
Protection class	standard IP65 (front), IP00 (back side)		
Weight	approx. 200 g		
Connection	plug-in terminal; wire cross-section up to 2.5 mm ²		
Display			
Digit height	14 mm		
Segment colour	red (optional green, orange or blue)		
Range of display	-19999 to 99999		
Setpoint	one LED per setpoint		
Overflow	horizontal bars at the top		
Underflow	horizontal bars at the bottom		
Display time	0.1 to 10.0 seconds		
Input	Ri	Measuring error	Digit
0...5 AAC TRMS	~ 0.05 Ω	0.5 % of final value	±1
0...300 VAC TRMS	~ 1 MΩ	0.5 % of final value	±1
Accuracy			
Drift of temperature	100 ppm / K		
Measuring time	0.1...10.0 seconds		
Measuring principle	U/F-conversion		
Resolution	approx. 18 bit at 1 second measuring time		
Output			
Analog output	0/4-20 mA / burden ≤500 Ohm, 0-10 VDC / burden ≥10 kOhm, 16 Bit		
Switching outputs			
Relay with change-over contact	250 VAC / 2 AAC; 30 VDC / 2 ADC		
Switching cycles	0.5 x 10 ⁵ at contact load 0.5 x 10 ⁶ mechanically Division according to DIN EN 50178 / Characteristics according to DIN EN 60255		

Power supply	100-240 VAC 50/60 Hz / DC $\pm 10\%$ (max. 10 VA)
Memory	EEPROM
Data life	≥ 100 years / 25°C
Ambient conditions	
Working temperature	0°C...50°C
Storing temperature	-20°C...80°C
Weathering resistance	relative humidity 0-80% on years average without dew
EMV	EN 61326, EN 55011
CE-sign	conformity according to directive 2014/30/EU
Safety standard	according to low voltage directive 2014/35/EU EN 61010; EN 60664-1

11. Error elimination

	Error description	Measures
1.	The unit permanently indicates overflow. 	<ul style="list-style-type: none"> The input has a very high measurement, check the measuring circuit. With a selected input with a low voltage signal, it is only connected on one side or the input is open. Not all of the activated setpoints are parameterised. Check if the relevant parameters are adjusted correctly.
2.	The unit permanently shows underflow. 	<ul style="list-style-type: none"> The input has a very low measurement, check the measuring circuit. With a selected input with a low voltage signal, it is only connected on one side or the input is open. Not all of the activated setpoints are parameterised. Check if the relevant parameters are adjusted correctly.
3.	The word HELP lights up in the 7-segment display.	<ul style="list-style-type: none"> The unit has found an error in the configuration memory. Perform a reset on the default values and reconfigure the unit according to your application.
4.	Program numbers for parameterising of the input are not accessible.	<ul style="list-style-type: none"> Programming lock is activated Enter correct code
5.	Err1 lights up in the 7-segment display.	<ul style="list-style-type: none"> Please contact the manufacturer if errors of this kind occur.
6.	The device does not react as expected.	<ul style="list-style-type: none"> If you are not sure that the device has been parameterised before, then follow the steps as written in <i>chapter 6</i> and set it back to its delivery status.