

User manual IM3

Pt100 3-/4-wire -200.0°C...850.0°C / -328.0°F...1562.0°F



Technical features:

- red display of -19999...99999 digits (optional: green, orange or blue display)
- installation depth: 120 mm without plug-in terminal
- min/max memory
- optical threshold value indication at threshold value exceedance / undercut
- permanent min/max-value recording
- brightness control
- programming interlock via access code
- protection class IP65 at the front
- plug-in terminal
- option: 1 or 2 analog outputs
- option: 2 or 4 relay outputs or 8 PhotoMos outputs
- option: interface RS232 or RS485
- accessories: PC-based configuration kit PM-TOOL incl. CD and USB-adapter for devices without keypad and for a simple adjustment of standard devices

Identification

STANDARD TYPES	ORDER NUMBER
Pt100 3-/4-wire Housing size: 96x48 mm	IM3-1TR5B.010C.S70xD IM3-1TR5B.010C.W70xD

Options – breakdown of order code:

	IM	3	-	1	T	R	5	B.	0	1	0	C.	6	7	2	x	D		
Standard type M-line																			Dimension
																			<input type="checkbox"/> D physical unit
Installation depth mm																			Version
139 mm, incl. plug-in terminal																			<input type="checkbox"/> x internal version
Housing size																			Switching points
96x48x120 mm (BxHxD)																			<input type="checkbox"/> 0 no switching points
																			<input type="checkbox"/> 2 2 relay outputs
																			<input type="checkbox"/> 4 4 relay outputs
																			<input type="checkbox"/> 8 8 PhotoMos-outputs
Type of display																			Protection class
Temperature																			<input type="checkbox"/> 1 without keypad, operation via PM-TOOL
Display colour																			<input type="checkbox"/> 7 IP65 / plug-in terminal
Blue																			
Green																			
Red																			
Orange																			
Number of digits																			Supply voltage
5-digit																			<input type="checkbox"/> S 100-240 VAC, DC +/- 10%
																			<input type="checkbox"/> W 10-40 VDC galv. isolated, 18-30 VDC
Digit height																			Measuring input
14 mm																			<input type="checkbox"/> C Pt100
Digital input																			Analog output
without																			<input type="checkbox"/> 0 without
Interface RS232																			<input type="checkbox"/> X 1x 0-10 VDC, 0/4-20 mA
Interface RS485																			<input type="checkbox"/> Y 2x 0-10 VDC, 0/4-20 mA
Temperature devices																			
Pt100 3-/4-wire																			

Please state physical unit by order, e.g. °C

Contents

1. Brief description	2
2. Assembly	3
3. Electrical connection	4
4. Function description and operation	5
4.1. Programming software PM-TOOL	6
5. Setting up the device	7
5.1. Switching on	7
5.2. Standard parameterisation (flat operation level)	7
Value assignment for the triggering of the signal input	
5.3. Programming interlock „RUN“	9
Activation/Deactivation of the programming interlock or change into professional or flat operation level	
5.4. Extended parameters (professional operation level)	10
5.4.1. Signal input parameters „INP“	10
Value assignment for the triggering of the signal input	
5.4.2. General device parameters „FCT“	12
Superior device functions like min/max permanent, brightness control, as well as the control of the keyboard layout	
5.4.3. Safety parameters „COD“	14
Assignment of user and master code to lock or to receive access to defined parameter such as analog output and alarms, etc.	
5.4.4. Serial parameters „SER“	15
Parameter for interface definition	
5.4.5. Analog output parameters „OUT“	16
Analog output functions	
5.4.6. Relay functions „REL“	19
Parameter for setpoint definition	
5.4.7. Alarm parameters „AL1...AL4“	21
Actuator and dependencies of the alarms	
6. Reset to factory settings	22
Reset parameters onto the delivery state	
7. Alarms / Relays	23
Functional principle of the switching outputs	
8. Interfaces	24
Connection RS232 and RS485	
9. Technical data	25
10. Safety advices	27
11. Error elimination	28

1. Brief description

The panel meter instrument **IM3-1C** is a 5-digit device for Pt100 sensors and a visual threshold value monitoring via the display. The configuration happens via four keys at the front or by the optional PC software PM-TOOL. The integrated programming interlock prevents unrequested changes of parameters and can be unlocked again with an individual code. Optional the following functions are available: two analog outputs and interfaces for further evaluating in the unit.

With help of the galvanic isolated setpoints (optional), free adjustable limit values can be controlled and reported to a superior master display.

The electrical connection is done via plug-in terminals on the back side.

Selectable functions like e.g. the recall of the min/max-value, a direct threshold value regulation during operation mode, complete the modern device concept.

2. Assembly

Please read the *Safety advices* on page 27 before installation and keep this user manual for future reference.

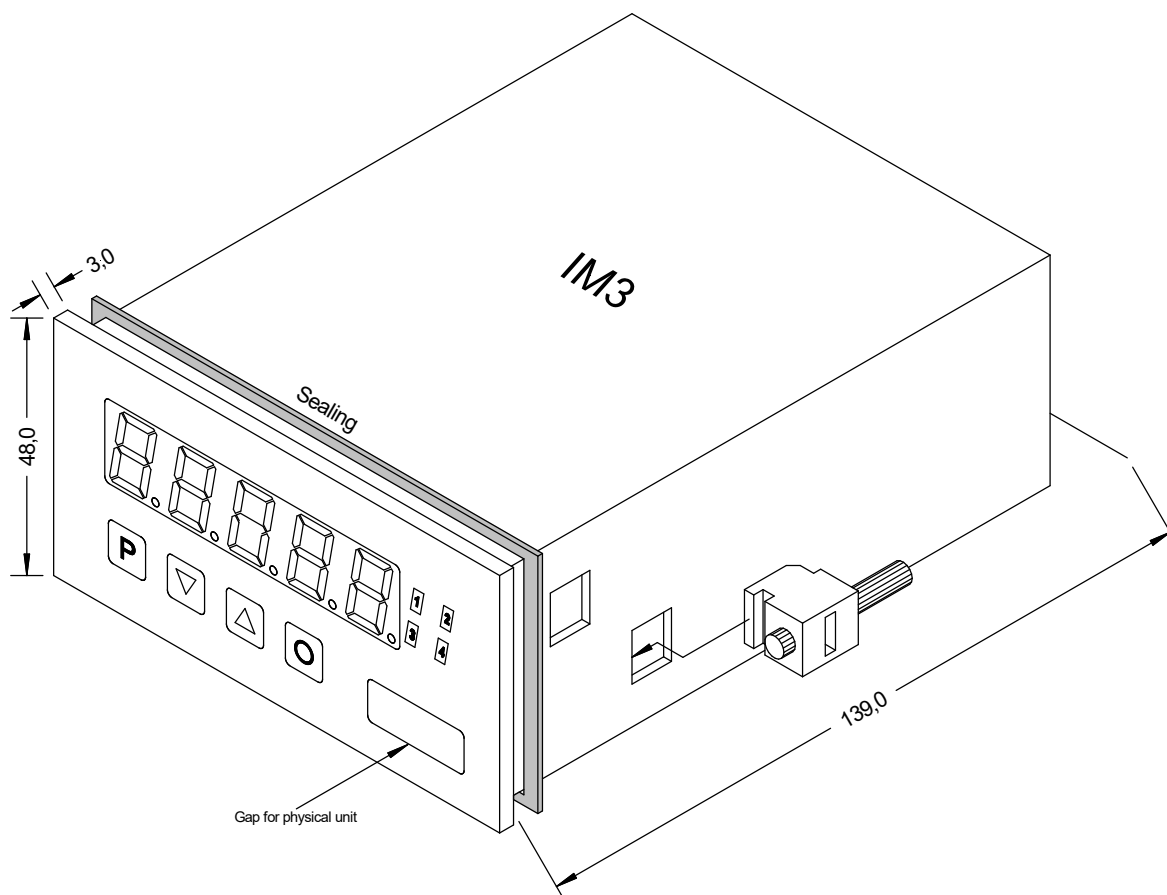

1. After removing the fixing elements, insert the device.
2. Check the seal to make sure it fits securely.
3. Click the fixing elements back into place and tighten the clamping screws by hand. Then use a screwdriver to tighten them another half a turn.

CAUTION! The torque should not exceed 0.1 Nm!

The dimension symbols can be exchanged before installation via a channel on the side!

3. Electrical connection

Type IM3-1TR5B.010C.W70xD supply 10-40 VDC, galv. isolated, 18-30 VAC
Type IM3-1TR5B.010C.S70xD supply 100-240 VAC, DC \pm 10%

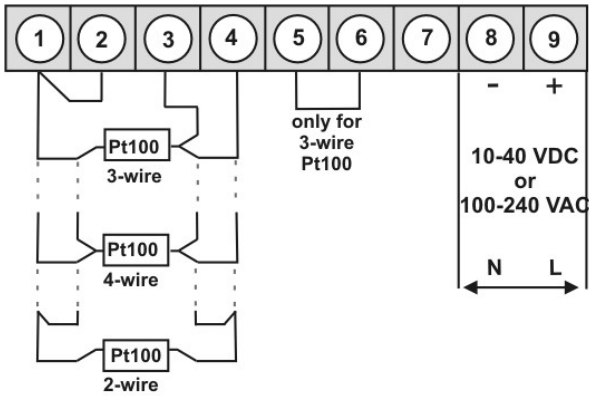

Options:

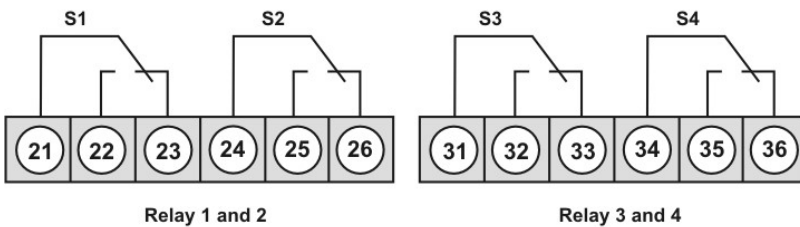
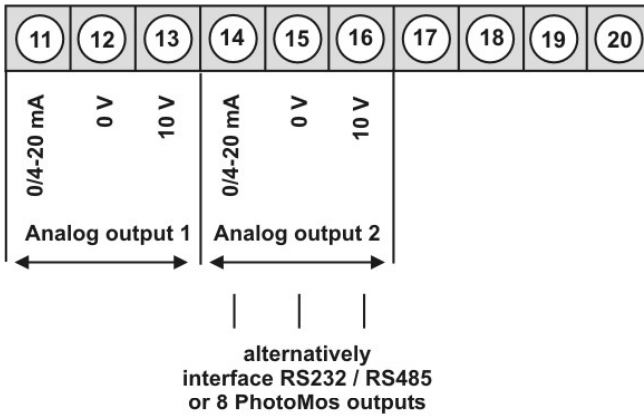

Alternative to analog output 2

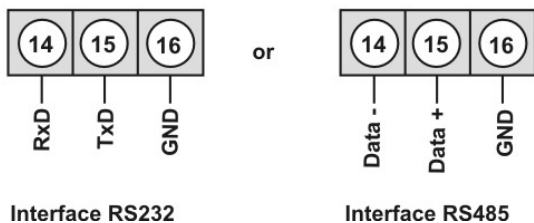
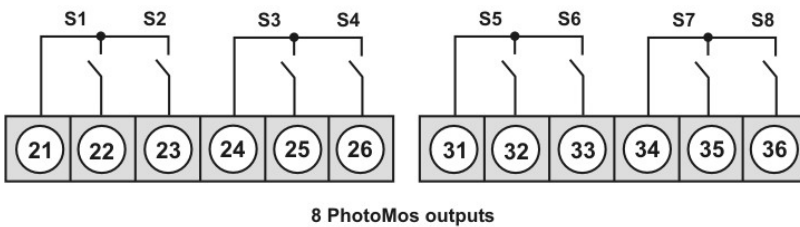

4. Function and operation description

Operation

The operation is divided into three different levels.

Menu level (delivery status)













This level was designed for the standard settings of the device. Only menu items which are sufficient to set the device into operation are displayed. To get into the professional level, run through the menu level and parameterise *PROF* under menu item *RUN*.

Menu group level (complete function volume)

Suited for complex applications as e.g. linkage of alarms, setpoint treatment, totaliser function etc. In this level function groups which allow an extended parameterisation of the standard settings are available. To leave the menu group level, run through this level and parameterise *ULOC* under menu item *RUN*.

Parameterisation level:

Parameter deposited in the menu item can here be parameterised. Functions, that can be changed or adjusted, are always signalled by a flashing of the display. Settings that are made in the parameterisation level are confirmed with **[P]** and thus saved. Pressing the **[O]-key** leads to a break-off of the value input and to a change into the menu level. All adjustments are saved automatically by the device and changes into operating mode, if no further key operation is done within the next 10 seconds.

Level	Key	Description
Menu-level		Change to parameterisation level and deposited values.
	 	Keys for up and down navigation in the menu level.
		Change into operation mode.
Parameterisation-level		To confirm the changes made at the parameterization level.
	 	Adjustment of the value / the setting.
		Change into menu level or break-off in value input.
Menu-group-level		Change to menu level.
	 	Keys for up and down navigation in the menu group level.
		Change into operation mode or back into menu level.

Function chart:

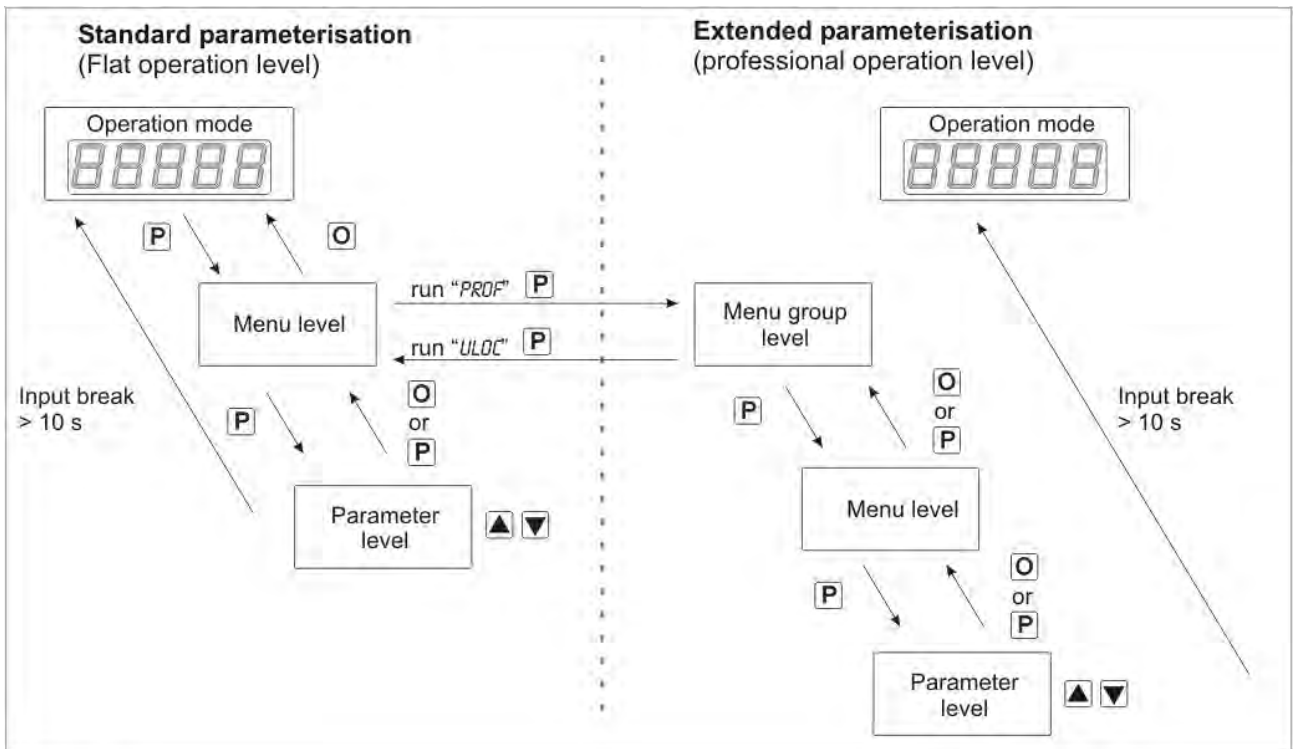

Underline:

- P** Takeover
- O** Stop
- ▲** Value selection (+)
- ▼** Value selection (-)

4.1 Parameterisation software PM-TOOL:

Part of the PM-TOOL are the software on CD and an USB-cable with device adapter. The connection happens via a 4-pole micromatch-plug on the back side of the device, to the PC-side the connection happens via an USB plug.

System requirements: PC incl. USB interface
 Software: Windows XP, Windows VISTA

With this tool the device configuration can be generated, omitted and saved on the PC. The parameters can be changed via the easy to handle program surface, whereat the operating mode and the possible selection options can be preset by the program.

5. Setting up the device

5.1. Switching on



Once the installation is complete, start the device by applying the voltage supply. Before, check once again that all electrical connections are correct.





Starting sequence

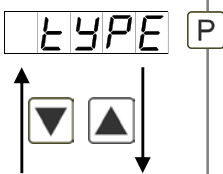
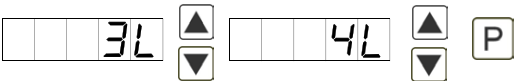
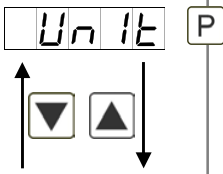
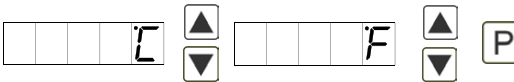
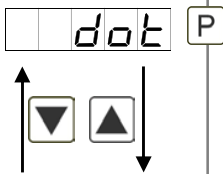
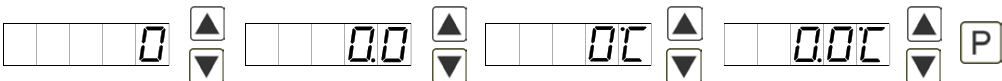
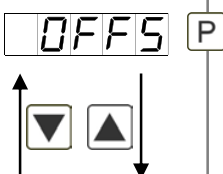



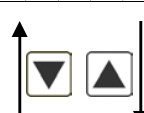

For 1 second during the switching-on process, the segment test ($\theta \theta \theta \theta \theta$) is displayed followed by an indication of the software type and, after that, also for 1 second the software version. After the starting sequence, the device switches to operation/display mode.

5.2. Standard parameterisation: (Flat operation level)

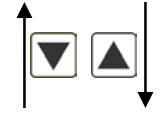
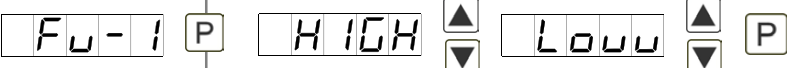
To parameterise the display, press the **[P]-key** in operating mode for 1 second. The display then changes to the menu level with the first menu item *TYPE*.

Menu level	Parameterisation level
	<p>Selection of the input signal, <i>TYPE</i>: Default: 4L</p>  <p>Available as measuring input types are 3- and 4-wire-Pt100 signals. Confirm the selection with [P] and the display switches back to menu level.</p>
	<p>Type of temperature metering, <i>UNIT</i>: Default: °C</p>  <p>The temperature can be displayed in °C or in °F. Confirm the selection with [P] and the display switches back to menu level.</p>
	<p>Setting the decimal point, <i>DOT</i>: Default: 0.0</p>  <p>The decimal point on the display and the physical unit can be changed with [▲] [▼]. If e.g. temperature measurement in °C was selected, one can choose between 0°C and 0.0°C in the parameterisation level. Confirm with [P], the display then switches back to the menu level again.</p>
	<p>Impedance matching, <i>OFFS</i>: Default: 0.0</p>  <p>The value for the sensor calibration is selectable from the smallest to the highest digit with [▲] [▼] and confirmed with [P]. After the last digit the display switches back to the menu level again. The value calibration for a temperature measurement in °C can be adjusted between -20.0 and +20.0 and in °F between -36.0 and +36.0. If the type of the measurement is changed later, then the value is rounded.</p>

Menu level	Parameterisation level
	<p>Setting up the display time, SEC: Default: 1.0</p> <p>SEC P 00.1 ▲ 00.9 then 0.10 ▼ 10.0 ▼ P</p> <p>The display time is set with [▲] [▼]. The display moves up in increments of 0.1 up to 1 second and in increments of 1.0 up to 10.0 seconds. Confirm the selection by pressing the [P] button. The display then switches back to the menu level again.</p>
	<p>Selection of analog output, OUT.RA: Default: 4-20</p> <p>Out.RA P 0-10 ▼ 0-20 ▼ 4-20 ▼ P</p> <p>Three output signals are available: 0-10 VDC, 0-20 mA and 4-20 mA, with this function, the demanded signal is selected.</p>
	<p>Setting up the final value of the analog output, OUT.EN: Default: 850.0</p> <p>Out.EN P 8 P 8 P 8 P 8 P 8 ▼ P</p> <p>The final value is adjusted from the smallest digit to the highest digit with [▲] [▼] and digit by digit confirmed with [P]. A minus sign can only be parameterised on the highest digit. After the last digit, the device changes back into menu level.</p>
	<p>Setting up the initial value of the analog output, OUT.OF: Default: -200.0</p> <p>Out.OF P 8 P 8 P 8 P 8 P 8 ▼ P</p> <p>The final value is adjusted from the smallest digit to the highest digit with [▲] [▼] and digit by digit confirmed with [P]. A minus sign can only be parameterised on the highest digit. After the last digit, the device changes back into menu level.</p>
	<p>Threshold values / limits, LI-1: Default: 200.0</p> <p>LI-1 P 0 P 0 P 0 P 0 P 0 ▼ P</p> <p>This value defines the threshold, that activates/deactivates an alarm.</p>
	<p>Hysteresis for limit values, HY-1: Default: 0.0</p> <p>HY-1 P 0 P 0 P 0 P 0 P 0 ▼ P</p> <p>The delayed reaction of the alarm is the difference to the threshold value, which is defined by the hysteresis.</p>

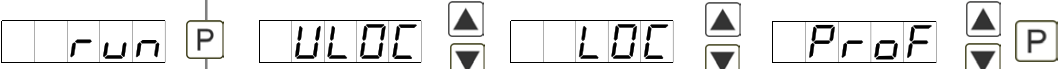

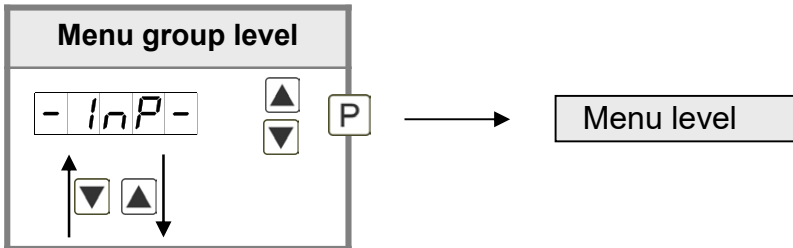

Menu level	Parameterisation level
	<p>Function for threshold value undercut / exceedance, FU-1: Default: <i>HIGH</i></p> <p></p> <p>A limit value undercut is selected with <i>LOW</i> (for LOW = lower limit value), a limit value exceedance with <i>HIGH</i> (for HIGH = higher limit value). If e.g. limit value 1 is on a threshold level of 100 and allocated with function <i>HIGH</i>, an alarm is activated by reaching of the threshold level. If the threshold value was allocated to <i>LOW</i>, an alarm will be activated by undercutting the threshold value, as long as the hysteresis is zero.</p>
	<p>The same applies to LI-2!</p>
	<p>User code (4-digit number-combination, free available), U.CODE: Default: <i>0000</i></p> <p></p> <p>If this code was set (>0000), all parameters are locked for the user, if <i>LOC</i> has been selected before under menu item <i>RUN</i>. By pressing [P] for 3 seconds in operation mode, the display shows <i>CODE</i>. The <i>U.CODE</i> needs to be entered to get to the reduced number of parameter sets. The code has to be entered before each parameterisation, until the <i>A.CODE</i> (Master code) unlocks all parameters again.</p>
	<p>Master code (4-digit number-combination, free available), A.CODE: Default: <i>1234</i></p> <p></p> <p>All parameters can be unlocked with this code, after <i>LOC</i> has been activated under menu item <i>RUN</i>. By pressing [P] for 3 seconds in operation mode, the display shows <i>CODE</i> and enables the user to reach all parameters by entering the <i>A.CODE</i>. Under <i>RUN</i> the parameterisation can be activated permanently by selecting <i>ULOC</i> or <i>PROF</i>, thus at an anew pushing of [P] in operation mode, the code needs not to be entered again.</p>
<p>5.3. Programming interlock „RUN“</p>	
	<p>Activation / deactivation of the programming lock or completion of the standard parameterisation with change into menu group level (complete function range), RUN: Default: <i>ULOC</i></p> <p></p> <p>With the navigation keys [▲] [▼], choose between the deactivated key lock <i>ULOC</i> (works setting) and the activated key lock <i>LOC</i>, or the change into the menu group level <i>PROF</i>. Confirm the selection with [P]. After this, the display confirms the settings with "- - - -", and automatically switches to operating mode. If <i>LOC</i> was selected, the keyboard is locked. To get back into the menu level, press [P] for 3 seconds in operating mode. Now enter the <i>CODE</i> (works setting <i>1 2 3 4</i>) that appears using [▲] [▼] plus [P] to unlock the keyboard. <i>FAIL</i> appears if the input is wrong. To parameterise further functions <i>PROF</i> needs to be set. The device confirms this setting with „- - - -“, and changes automatically in operation mode. By pressing [P] for approx. 3 seconds in operation mode, the first menu group <i>INP</i> is shown in the display and thus confirms the change into the extended parameterisation. It stays activated as long as <i>ULOC</i> or <i>LOC</i> is entered in menu group <i>RUN</i>.</p>

5.4. Extended parametrisation (Professional operation level)

5.4.1. Signal input parameters

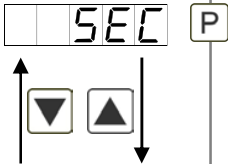
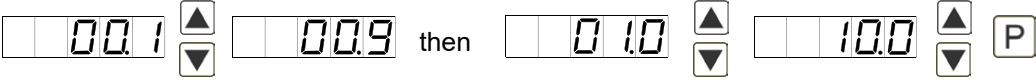
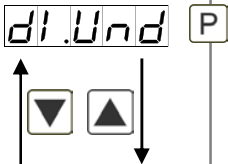

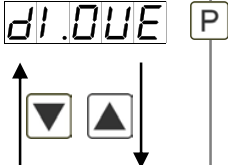
Menu level	Parameterisation level
	<p>Selection of the input signal, TYPE: Default: 4L</p> <p>Available as measuring input types are 3- and 4-wire-Pt100 signals. Confirm the selection with [P] and the display switches back to menu level.</p>
	<p>Type of temperature metering, UNIT: Default: °C</p> <p>The temperature can be displayed in °C or in °F. Confirm the selection with [P] and the display switches back to menu level.</p>
	<p>Setting the decimal point, DOT: Default: 0.0</p> <p>The decimal point on the display and the physical unit can be changed with [▲] [▼]. If e.g. temperature measurement in °C is selected, then you can choose between 0°C and 0.0°C in the parameterisation level. Confirm with [P], the display then switches back to the menu level again.</p>
	<p>Impedance matching, DOT: Default: 0.0</p> <p>The value for the sensor calibration is selectable from the smallest to the highest digit with [▲] [▼] and confirmed with [P]. After the last digit the display switches back to the menu level again. The value calibration for a temperature measurement in °C can be adjusted between -20.0 and +20.0 and in °F between -36.0 and +36.0. If the type of the measurement is changed later, then the value is rounded.</p>

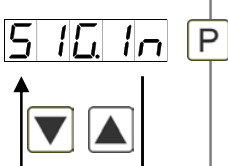
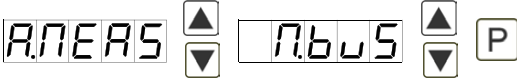
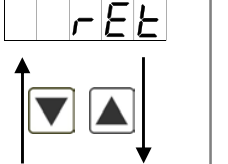
Menu level	Parameterisation level
	<p>Setting up the display time, SEC: Default: 1.0</p>  <p>The display time is set with [▲] [▼]. The display moves up in increments of 0.1 up to 1 second and in increments of 1.0 up to 10.0 seconds. Confirm the selection by pressing the [P] button. The display then switches back to the menu level again.</p>
	<p>Device undercut, DI.UND: Default: -19999</p>  <p>With this function the device undercut (____) can be defined on a definite value. Exception is input type 4-20 mA, it already shows undercut at a signal <1 mA, so a sensor failure is marked.</p>
	<p>Display overflow, DI.OUE: Default: 99999</p>  <p>With this function the display overflow (-----) can be defined on a definite value.</p>
	<p>Input variable of process value, SIG.IN: Default: R.MEAS</p>  <p>With this parameter, the device can be controlled via the analog input signals R.MEAS = 0-20 mA, 4-20 mA or 0-10 VDC or via the digital signals of the interface M.BUS = RS232/RS485 (Modbus protocol). With [P] the selection is confirmed and the device changes into menu level.</p>
	<p>Back to menu group level, RET:</p> <p>With [P] the selection is confirmed and the device changes into menu group level „-INP-“.</p>

5.4.2. General device parameters

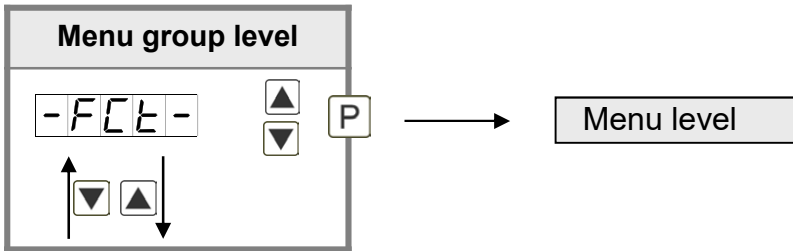

Menu level	Parameterisation level
	<p>Display time, <i>DISC</i>: Default: 01.0</p> <p>01.5EC P 00.1 ▲ ▼ 00.9 then 01.0 ▲ ▼ 10.0 ▲ ▼ P</p> <p>The display is set up with [▲] [▼]. Thereby it switches up to 1 second in increments of 0.1 seconds and up to 10.0 seconds in increments of 1.0. With [P] the selection is confirmed and the device changes into menu level.</p>
	<p>Rounding of display values, <i>ROUND</i>: Default: 00001</p> <p>round P 00001 ▲ ▼ 00005 ▲ ▼ 00010 ▲ ▼ 00050 ▲ ▼ P</p> <p>This function is for instable display values, where the display value is changed in increments of 1, 5, 10 or 50. This does not affect the resolution of the optional outputs. With [P] the selection is confirmed and the device changes into menu level.</p>
	<p>Display, <i>DISPL</i>: Default: ACTUA</p> <p>di SPL P ActUA ▲ ▼ mi nUA ▲ ▼ MAXUA ▲ ▼ P</p> <p>With this function the current measuring value or the min/max value can be allocated to the display. With [P] the selection is confirmed and the device changes into menu level.</p>
	<p>Brightness control, <i>LIGHT</i>: Default: 15</p> <p>LIGHE P 00 ▲ ▼ 15 ▲ ▼ P</p> <p>The brightness of the display can be adjusted in 16 levels from 00 = very dark to 15 = very bright via this parameter or alternatively via the navigation keys from the outside. During the start of the device the level that is deposited under this parameter will always be used, even though the brightness has been changed via the navigation keys in the meantime.</p>

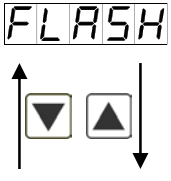
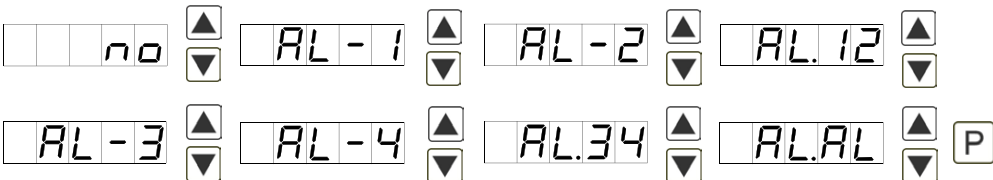
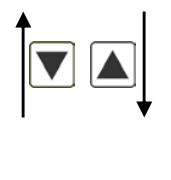
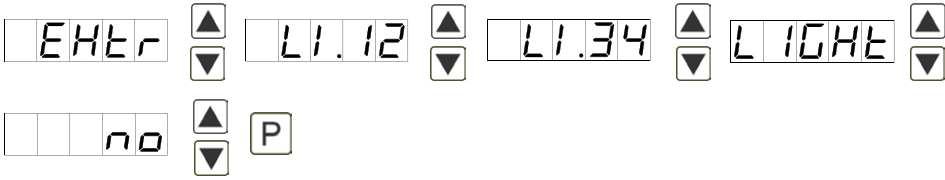
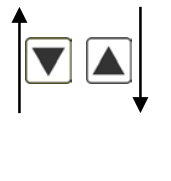
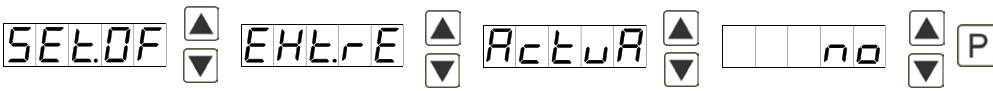
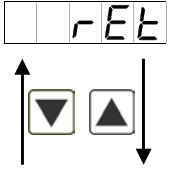
Menu level	Parameterisation level
 <p>FLASH P</p>	<p>Display flashing, FLASH: Default: <i>NO</i></p> <p>  </p> <p>A display flashing can be added as additional alarm function either to single or to a combination of off-limit condition. With <i>NO</i>, no flashing is allocated.</p>
 <p>EAST P</p>	<p>Assignment (deposit) of key functions, EAST: Default: <i>NO</i></p> <p>  </p> <p>For the operation mode, special functions can be deposited on the navigation keys [▲] [▼], in particular this function is made for devices in housing size 48x24mm which do not have a 4th key ([O]-key). If the min/max-memory was activated by <i>EHTR</i>, all measured min/max-values are saved during operation and can be recalled via the navigation keys. The values get lost by restart of the device. If the threshold value correction <i>LI.12</i> or <i>LI.34</i> is chosen, the values of the threshold can be changed during operation without disturbing the operating procedure. Under <i>LIGHT</i> the brightness can be changed during operation. If <i>NO</i> was selected, the navigation keys are without any function in the operation mode.</p>
 <p>EAST.4 P</p>	<p>Special function [O]-key, EAST.4: Default: <i>NO</i></p> <p>  </p> <p>For the operation mode, special functions can be deposited on the [O]-key. This function is activated by pressing the key. <i>SET.OF</i> adds a defined value to the currently displayed value. <i>EHT.RE</i> deletes the min/max-memory. <i>ACTUA</i> shows the measuring value for approx. 7 seconds, after this the device switches back onto the parameterised display value. If <i>NO</i> was selected, the [O]-key is without any function in the operation mode.</p>
 <p>RET</p>	<p>Back to menu group level, RET:</p> <p>With [P] the selection is confirmed and the device changes into menu group level „-FCT-“.</p>

5.4.3. Safety parameters

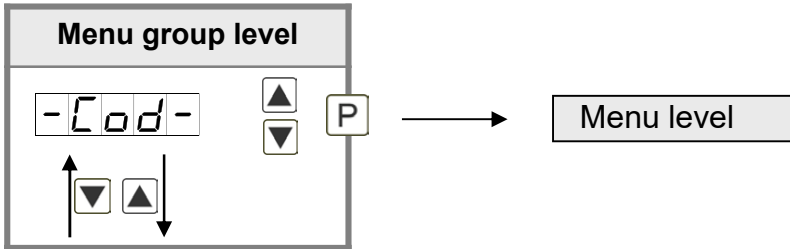

Menu level	Parameterisation level
	<p>User code, U.CODE: Default: 0000</p> <p>Via this code reduced sets of parameters can be set free. A change of the U.CODE can be done via the correct input of the R.CODE (master code).</p>
	<p>Master code, R.CODE: Default: 1234</p> <p>By entering R.CODE the device will be unlocked and all parameters are released.</p>
	<p>Release/lock analog output parameter, OUT.LE: Default: ALL</p> <p>Analog output parameter can be locked or released for the user:</p> <ul style="list-style-type: none"> - EN-OF: the initial or final value can be changed in operation mode - OUT.EO: the output signal can be changed from e.g. 0-20 mA to 4-20 mA or 0-10 VDC - ALL: analog output parameters are released - NO: all analog output parameters are locked
	<p>Release/lock alarm parameters, AL.LEU: Default: ALL</p> <p>This parameter describes the user release/user lock of the alarm:</p> <ul style="list-style-type: none"> - LIMIT: here only the range of value of the threshold values 1-4 can be changed - ALRM.L: here the range of value and the alarm trigger can be changed - ALL: all alarm parameters are released - NO: all alarm parameters are locked
	<p>Back to menu group level, RET:</p> <p>With [P] the selection is confirmed and the device changes into menu group level „-COD-“.</p>



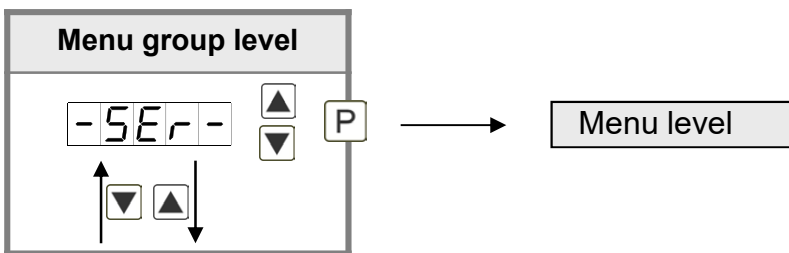



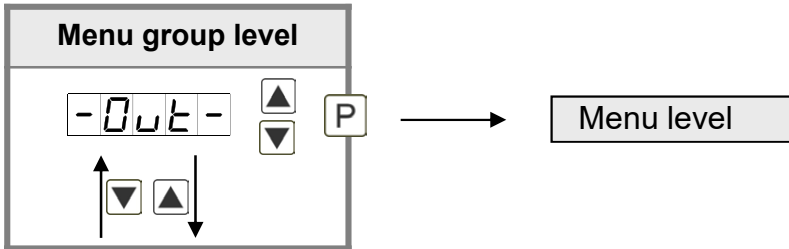

5.4.4. Serial parameters

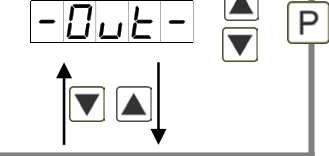

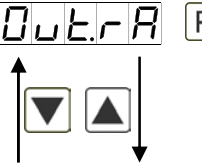

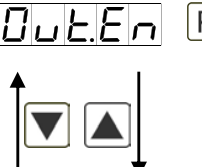
Menu level	Parameterisation level
	<p>Device address, ADDR: Default: 001</p> <p>The device address is adjusted from the smallest to the largest digit with the navigation keys [▲] [▼] and confirmed digit per digit with [P]. A device address up to max. 250 is available. Interface data: Baudrate 9600 bit/s, 8 databyte, 1 stopbit, no parity (8n1).</p>
	<p>ModBus operating modes, B.MODE: Default: ASCII</p> <p>There are two different types of operating modes: <i>ASCII</i> and <i>RTU</i>. Modbus transfers no binary cycle, but the ASCII-Code. Thus it is directly readable, however the data throughput is smaller in comparison to the RTU. Modbus RTU (RTU = Remote Terminal Unit) transfers the data in binary-coded. This leads to a good data throughput, even though the data cannot be evaluated directly, as they first need to be transferred into a readable format.</p>
	<p>Timeout, TIOUT: Default: 000</p> <p>The monitoring of the data transfer is parameterised in seconds up to max. 100 seconds; there is no monitoring with an input of 000. The timeout is adjusted from the smallest to the largest digit with the navigation keys [▲] [▼] and confirmed digit per digit with [P]. After the last digit the device changes back into menu level.</p>
	<p>Back to menu group level, RET:</p> <p>With [P] the selection is confirmed and the device changes into menu group level „-SER-“.</p>

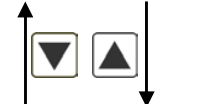
5.4.5. Analog output parameters for analog output 1



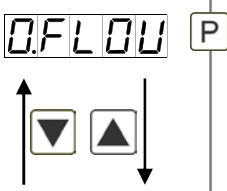

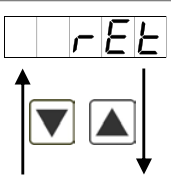

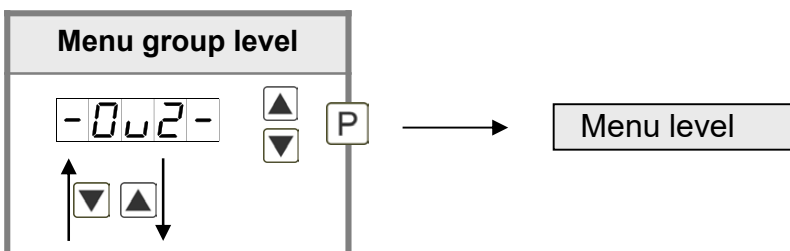

Menu level	Parameterisation level
	<p>Selection reference of analog output, <i>OUTPT</i>: Default: <i>ACTUA</i></p>  <p>The analog output signal can refer to different functions, in detail these are the current measurand, the min-value or the max-value. With [P] the selection is confirmed and the device changes into menu level.</p>
	<p>Selection analog output, <i>OUT.RA</i>: Default: <i>4-20</i></p>  <p>Three output signals are available 0-10 VDC, 0-20 mA and 4-20 mA. Select the desired signal with this function.</p>
	<p>Setting the final value of the analog output, <i>OUT.EN</i>: Default: <i>850.0</i></p>  <p>The final value is adjusted from the smallest to the highest digit with [▲] [▼] and confirmed digit per digit with [P]. A minus sign can only be parameterised on the highest digit. After the last digit the device changes back into menu level.</p>
	<p>Setting the initial value of the analog output, <i>OUT.OF</i>: Default: <i>-200.0</i></p>  <p>The initial value is adjusted from the smallest to the highest digit with [▲] [▼] and confirmed digit per digit with [P]. A minus sign can only be parameterised on the highest digit. After the last digit the device changes back into menu level.</p>

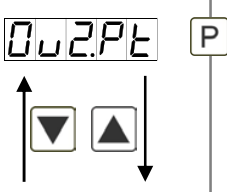
Menu level	Parameterisation level
	<p>Overflow behaviour, O.FLOW: Default: <i>EDGE</i></p> <p>  </p> <p>  </p> <p>To recognise and evaluate faulty signals, e.g. by a controller, the overflow behaviour of the analog output can be defined. As overflow can be seen either <i>EDGE</i>, that means the analog output runs on the set limits e.g. 4 and 20 mA, or <i>TO.OFF</i> (input value smaller than initial value, analog output switches on e.g. 4 mA), <i>TO.END</i> (higher than final value, analog output switches on e.g. 20 mA). If <i>TO.MIN</i> or <i>TO.MAX</i> is set, the analog output switches on the smallest or highest possible binary value. This means that values of e.g. 0 mA, 0 VDC or values higher than 20 mA or 10 VDC can be reached. With [P] the selection is confirmed and the device changes into menu level.</p>
	<p>Back to menu group level, rEt:</p> <p>With [P] the selection is confirmed and the device changes into menu group level „-OUT-“.</p>

Analog output parameters for analog output 2





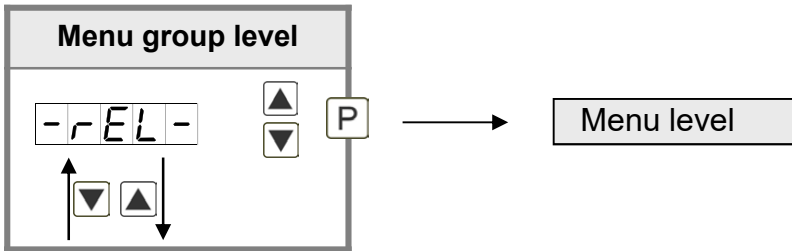

Menu level	Parameterisation level
	<p>Selection reference of analog output, OU2PT: Default: <i>ACTUA</i></p> <p>  </p> <p>The analog output signal can refer to different functions, in detail these are the current measurand, the min-value or the max-value. If <i>HOLD</i> was selected, the signal of the analog output will be kept. It can be continued processing after a deactivation of <i>HOLD</i>. With [P] the selection is confirmed and the device changes into menu level.</p>

Menu level	Parameterisation level
	<p>Selection analog output, <i>OU2.RA</i>: Default: 4-20</p> <p><i>OU2.RA</i> [P] 0-10 [▲] [▼] 0-20 [▲] [▼] 4-20 [▲] [▼] [P]</p> <p>3 output signals are available 0-10 VDC, 0-20 mA and 4-20 mA. Select the desired signal with this function.</p>
	<p>Setting the final value of the analog output, <i>OU2.EN</i>: Default: 850.0</p> <p><i>OU2.EN</i> [P] 8 [P] 8 [P] 8 [P] 8 [P] 8 [▲] [▼] [P]</p> <p>The final value is adjusted from the smallest to the highest digit with [▲] [▼] and confirmed digit per digit with [P]. A minus sign can only be parameterised on the highest digit. After the last digit the device changes back into menu level.</p>
	<p>Setting the initial value of the analog output, <i>OU2.OF</i>: Default: -200.0</p> <p><i>OU2.OF</i> [P] 8 [P] 8 [P] 8 [P] 8 [P] 8 [▲] [▼] [P]</p> <p>The initial value is adjusted from the smallest to the highest digit with [▲] [▼] and confirmed digit per digit with [P]. A minus sign can only be parameterised on the highest digit. After the last digit the device changes back into menu level.</p>
	<p>Overflow behaviour, <i>OU2.FL</i>: Default: <i>EDGE</i></p> <p><i>OU2.FL</i> [P] <i>EDGE</i> [▲] [▼] <i>to.END</i> [▲] [▼] <i>to.OFF</i> [▲] [▼] <i>to.MIn</i> [▲] [▼]</p> <p><i>to.MAX</i> [▲] [▼] [P]</p> <p>To recognise and evaluate faulty signals, e.g. by a controller, the overflow behaviour of the analog output can be defined. As overflow can be seen either <i>EDGE</i>, that means the analog output runs on the set limits e.g. 4 and 20 mA, or <i>TO.OFF</i> (input value smaller than initial value, analog output switches on e.g. 4 mA), <i>TO.END</i> (higher than final value, analog output switches on e.g. 20 mA). If <i>TO.MIN</i> or <i>TO.MAX</i> is set, the analog output switches on the smallest or highest possible binary value. This means that values of e.g. 0 mA, 0 VDC or values higher than 20 mA or 10 VDC can be reached. With [P] the selection is confirmed and the device changes into menu level.</p>
	<p>Back to menu group level, <i>RET</i>:</p> <p><i>RET</i></p> <p>With [P] the selection is confirmed and the device changes into menu group level „-OU2-“.</p>

5.4.6. Relay functions





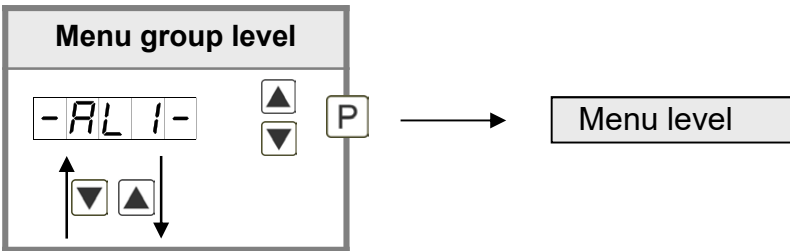

Menu level	Parameterisation level												
	<p>Alarm relay 1, REL-1: The same applies for relays 2-4 Default: AL-1</p> <p>REL-1 P AL-1 ... AL-4 AL-n1 ... AL-n4 LOGIC OFF On P</p> <p>Each setpoint (optional) can be linked up via 4 alarms (by default). This can either be inserted at activated alarms AL-1/4 or deactivated alarms ALN1/4. If LOGIC was selected, logical links are available in the menu level LOG-1 and COM-1. Access to these two menu levels is via LOGIC, at all other selected functions, these two parameters are overlapped. Via ON/OFF the setpoints can be activated/deactivated, in this case the output and the setpoint display are set/not set on the front of the device. With [P] the selection is confirmed and the device changes into menu level.</p>												
	<p>Logic relay 1, LOG-1: Default: OR</p> <p>LOG-1 P or nor And nAnd P</p> <p>Here, the switching behaviour of the relay is defined via a logic link, the following schema describes these functions with inclusion of AL-1 and AL-2. This parameter is only possible if LOGIC was selected under REL-1.</p> <table border="1"> <tr> <td>or</td> <td>$A1 \vee A2$</td> <td>As soon as a selected alarm is activated, the relay operates. Equates to operating current principle.</td> </tr> <tr> <td>nor</td> <td>$\overline{A1 \vee A2} = \overline{A1} \wedge \overline{A2}$</td> <td>The relay operates only, if no selected alarm is active. Equates to quiescent current principle.</td> </tr> <tr> <td>And</td> <td>$A1 \wedge A2$</td> <td>The relay operates only, if all selected alarms are active.</td> </tr> <tr> <td>nAnd</td> <td>$\overline{A1 \wedge A2} = \overline{A1} \vee \overline{A2}$</td> <td>As soon as a selected alarm is not activated, the relay operates.</td> </tr> </table> <p>With [P] the selection is confirmed and the device changes into menu level.</p>	or	$A1 \vee A2$	As soon as a selected alarm is activated, the relay operates. Equates to operating current principle.	nor	$\overline{A1 \vee A2} = \overline{A1} \wedge \overline{A2}$	The relay operates only, if no selected alarm is active. Equates to quiescent current principle.	And	$A1 \wedge A2$	The relay operates only, if all selected alarms are active.	nAnd	$\overline{A1 \wedge A2} = \overline{A1} \vee \overline{A2}$	As soon as a selected alarm is not activated, the relay operates.
or	$A1 \vee A2$	As soon as a selected alarm is activated, the relay operates. Equates to operating current principle.											
nor	$\overline{A1 \vee A2} = \overline{A1} \wedge \overline{A2}$	The relay operates only, if no selected alarm is active. Equates to quiescent current principle.											
And	$A1 \wedge A2$	The relay operates only, if all selected alarms are active.											
nAnd	$\overline{A1 \wedge A2} = \overline{A1} \vee \overline{A2}$	As soon as a selected alarm is not activated, the relay operates.											
	<p>Alarms for relay 1, COM-1: Default: A.1</p> <p>COM-1 P A.1 A.2 ... A.1234 P</p> <p>The allocation of the alarms to relay 1 happens via this parameter, one alarm or a group of alarms can be chosen. With [P] the selection is confirmed and the device changes into menu level.</p>												

Menu level	Parameterisation level												
	<p>Alarm relay 5, REL-5: Default: AL-5 The same applies for relays 6-8</p> <p>REL-5 [P] AL-5 AL-8 ▲▼ AL-n5 AL-n8 ▲▼</p> <p>LOGIC ▲▼ OFF ▲▼ On ▲▼ [P]</p> <p>Each setpoint (optional) can be linked up via 4 alarms (by default). This can either be inserted at activated alarms AL5/8 or deactivated alarms ALN5/8. If LOGIC is selected, logical links are available in the menu level LOG-1 and COM-1. Access to these two menu levels is via LOGIC, at all other selected functions, these two parameters are overlapped. Via ON/OFF the setpoints can be activated/deactivated, in this case the output and the setpoint display are set/not set on the front of the device. With [P] the selection is confirmed and the device changes into menu level.</p>												
	<p>Logic relay 5, LOG-5: Default: OR</p> <p>LOG-5 [P] or ▲▼ nor ▲▼ And ▲▼ nAnd ▲▼ [P]</p> <p>Here, the switching behaviour of the relay is defined via a logic link, the following schema describes these functions with inclusion of AL-1 and AL-2:</p> <table border="1" data-bbox="343 1048 1492 1377"> <tbody> <tr> <td>or</td> <td>$A1 \vee A2$</td> <td>As soon as a selected alarm is activated, the relay operates. Equates to operating current principle.</td> </tr> <tr> <td>nor</td> <td>$\overline{A1 \vee A2} = \overline{A1} \wedge \overline{A2}$</td> <td>The relay operates only, if no selected alarm is active. Equates to quiescent current principle.</td> </tr> <tr> <td>And</td> <td>$A1 \wedge A2$</td> <td>The relay operates only, if all selected alarms are active.</td> </tr> <tr> <td>nAnd</td> <td>$\overline{A1 \wedge A2} = \overline{A1} \vee \overline{A2}$</td> <td>As soon as a selected alarm is not activated, the relay operates.</td> </tr> </tbody> </table> <p>With [P] the selection is confirmed and the device changes into menu level.</p>	or	$A1 \vee A2$	As soon as a selected alarm is activated, the relay operates. Equates to operating current principle.	nor	$\overline{A1 \vee A2} = \overline{A1} \wedge \overline{A2}$	The relay operates only, if no selected alarm is active. Equates to quiescent current principle.	And	$A1 \wedge A2$	The relay operates only, if all selected alarms are active.	nAnd	$\overline{A1 \wedge A2} = \overline{A1} \vee \overline{A2}$	As soon as a selected alarm is not activated, the relay operates.
or	$A1 \vee A2$	As soon as a selected alarm is activated, the relay operates. Equates to operating current principle.											
nor	$\overline{A1 \vee A2} = \overline{A1} \wedge \overline{A2}$	The relay operates only, if no selected alarm is active. Equates to quiescent current principle.											
And	$A1 \wedge A2$	The relay operates only, if all selected alarms are active.											
nAnd	$\overline{A1 \wedge A2} = \overline{A1} \vee \overline{A2}$	As soon as a selected alarm is not activated, the relay operates.											
	<p>Alarms for relay 5, COM-5: Default: A.5</p> <p>COM-5 [P] A.5 ▲▼ A.6 ▲▼ A.5678 ▲▼ [P]</p> <p>The allocation of the alarms to relay 5 happens via this parameter, one alarm or a group of alarms can be chosen. With [P] the selection is confirmed and the device changes into menu level.</p>												
	<p>Back to menu group level, RET:</p> <p>RET</p> <p>With [P] the selection is confirmed and the device changes into menu group level „-REL-“.</p>												

5.4.7. Alarm parameters

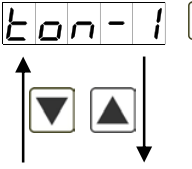

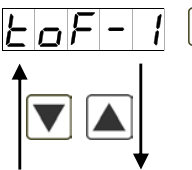
Menu level	Parameterisation level
<p data-bbox="124 772 295 817">-AL 1-</p> <p data-bbox="135 840 279 952">↑ ↓</p>	<p data-bbox="347 672 702 728">Dependency alarm 1, ALRM.1: Default: <i>ACTUA</i></p> <p data-bbox="124 772 1149 840">ALRM.1 P ACTUA MINUA MAXUA P</p> <p data-bbox="135 840 279 952">↑ ↓</p> <p data-bbox="347 873 1484 963">The dependency of alarm 1 can be related to special functions, in detail these are the current measuring value, the min-value, the max-value. With [P] the selection is confirmed and the device changes into menu level.</p> <p data-bbox="347 963 478 996">Example:</p> <p data-bbox="347 996 1484 1075">By using the maximum value <i>ALARM.1 = MAX.VA</i> in combination with a threshold monitoring <i>FU-1 = HIGH</i>, an alarm confirmation can be realised. Use the navigation keys, the 4th key or the digital input for confirmation.</p>
<p data-bbox="124 1176 295 1220">LI-1 P</p> <p data-bbox="135 1220 279 1332">↑ ↓</p>	<p data-bbox="347 1097 798 1153">Threshold values / limit values, LI-1: Default: <i>200.0</i></p> <p data-bbox="375 1176 1085 1254">0 P 0 P 0 P 0 P 0 P</p> <p data-bbox="135 1220 279 1332">↑ ↓</p> <p data-bbox="347 1299 1212 1332">The limit value defines the threshold, that activates/deactivates an alarm.</p>
<p data-bbox="124 1422 295 1467">HY-1 P</p> <p data-bbox="135 1467 279 1579">↑ ↓</p>	<p data-bbox="347 1344 813 1400">Hysteresis for threshold values, HY-1: Default: <i>0.0</i></p> <p data-bbox="375 1422 1085 1500">0 P 0 P 0 P 0 P 0 P</p> <p data-bbox="135 1467 279 1579">↑ ↓</p> <p data-bbox="347 1512 1484 1579">The delayed reaction of the alarm is the difference to the threshold value, which is defined by the hysteresis.</p>
<p data-bbox="124 1668 295 1713">FU-1 P</p> <p data-bbox="135 1713 279 1848">↑ ↓</p>	<p data-bbox="347 1590 1069 1646">Function for threshold value undercut / exceedance, FU-1: Default: <i>HIGH</i></p> <p data-bbox="375 1668 909 1747">HIGH LOW P</p> <p data-bbox="135 1713 279 1848">↑ ↓</p> <p data-bbox="347 1758 1484 1892">A limit value undercut is selected with <i>LOW</i> (for LOW = lower limit value), a limit value exceedance with <i>HIGH</i> (for HIGH = higher limit value). If e.g. limit value 1 is on a threshold level of 100 and allocated with function <i>HIGH</i>, an alarm is activated by reaching of the threshold level. If the threshold value was allocated to <i>LOW</i>, an alarm will be activated by undercutting the threshold value, as long as the hysteresis is zero.</p>

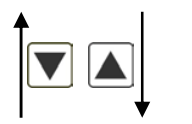
Menu level	Parameterisation level
	<p>Switching-on delay, <i>TON-1</i>: Default: 000</p>  <p>For limit value 1 one can preset a delayed switching-on of 0-100 seconds.</p>
	<p>Switching-off delay, <i>TOF-1</i>: Default: 000</p>  <p>For limit value 1 one can preset a delayed switching-off of 0-100 seconds.</p>
	<p>Back to menu group level, <i>RET</i>:</p> <p>With [P] the selection is confirmed and the device changes into menu group level „-AL1-“.</p>

The same applies for *AL2* to *ALB*.

Programming interlock, *RUN*:

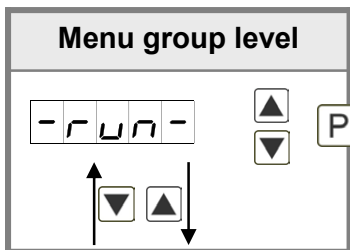

Description see page 9, menu level *RUN*

6. Reset to factory settings

To return the unit to a **defined basic state**, a reset can be carried out to the default values. The following procedure should be used:

- Switch off the power supply
- Press **[P]**-button
- Switch on voltage supply and press **[P]**-button until „- - - -“ is shown in the display.

With reset, the default values of the program table are loaded and used for subsequent operation. This puts the unit back to the state in which it was supplied.

Caution! All application-related data are lost.

7. Alarms / Relays

This device has 4 virtual alarms that can monitor one limit value in regard of an undercut or exceedance. Each alarm can be allocated to an optional relay output S1-S4; furthermore alarms can be controlled by events like e.g. min/max-value.

Function principle of alarms / relays	
Alarm / Relay x	Deactivated, instantaneous value, min/max-value or an activation via the [O]-key
Switching threshold	Threshold / limit value of the change-over
Hysteresis	Broadness of the window between the switching thresholds
Working principle	Operating current / Quiescent current

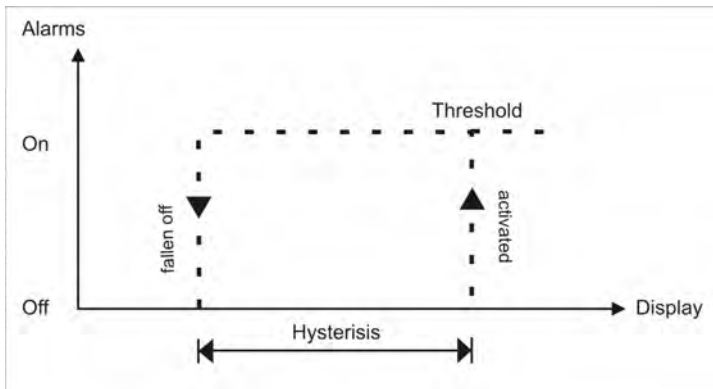

Operating current

By operating current the alarm S1-S4 is **off** below the threshold and **on** on reaching the threshold.

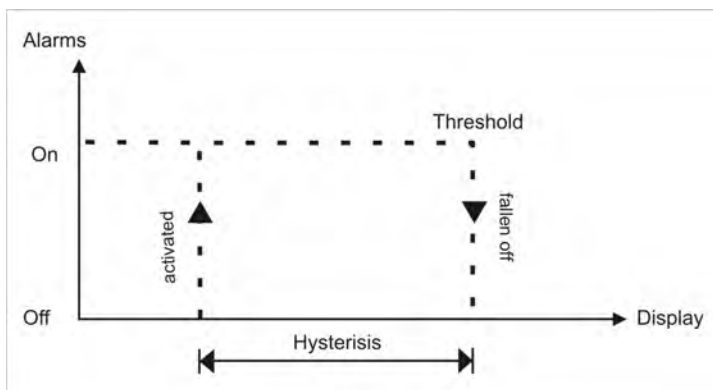

Quiescent current

By quiescent current the alarm S1-S4 is **on** below the threshold and switched **off** on reaching the threshold.

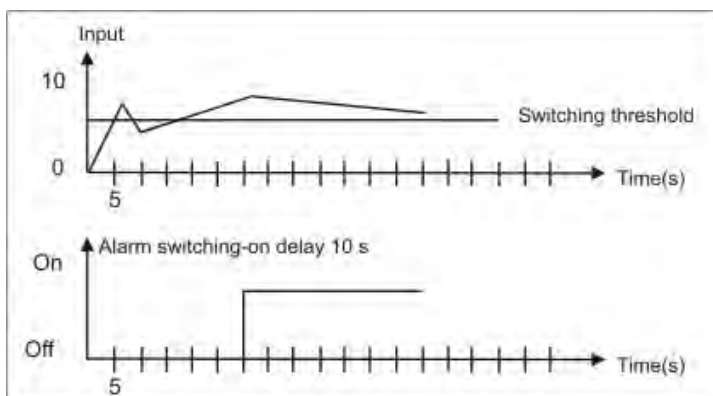

Switching-on delay

The switching-on delay is activated via an alarm and e.g. switched 10 seconds after reaching the switching threshold, a short-term exceedance of the switching value does not cause an alarm, respectively does not cause a switching operation of the relay. The switching-off delay operates in the same way, keeps the alarm / the relay switched longer for the parameterised time.

8. Interfaces RS232 and RS485

Connection RS232

Digital device M3

PC - 9-pole Sub-D-plug



Connection RS485

Digital device M3

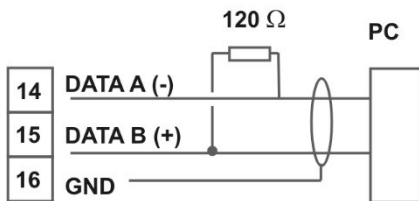

The interface **RS485** is connected via a screened data line with twisted wires (Twisted-Pair). On each end of the bus segment a termination of the bus lines needs to be connected. This is necessary to ensure a secure data transfer to the bus. For this a resistance (120 Ohm) is interposed between the lines Data B (+) and Data A (-).

9. Technical data

Housing			
Dimensions	96x48x120 mm (BxHxD)		
	96x48x139 mm (BxHxD) incl. plug-in terminal		
Panel cut-out	92.0 ^{+0,8} x 45.0 ^{+0,6} mm		
Wall thickness	to 15 mm		
Fixing	screw elements		
Material	PC Polycarbonate, black, UL94V-0		
Sealing material	EPDM, 65 Shore, black		
Protection class	standard IP65 (Front), IP00 (Back side)		
Weight	approx. 300 g		
Connection	plug-in terminal; wire cross section up to 2.5 mm ²		
Display			
Digit height	14 mm		
Segment colour	red (optional blue/green/orange)		
Range of display	-19999 to 99999		
Setpoints	one LED per setpoint		
Overflow	horizontal bars at the top		
Underflow	horizontal bars at the bottom		
Display time	0.1 to 10.0 seconds		
Input	Measuring range	Measuring error	Digit
Pt100 3-/4-wire	-200.0...850.0°C	0.1 % of measuring range	±1
Pt100 3-/4-wire	-328.0...1562.0°F	0.1 % of measuring range	±1
Accuracy			
Temperature drift	100 ppm / K		
Measuring time	0.1...10.0 seconds		
Measuring principle	U/F-converter		
Resolution	approx 0.1°C or 0.1°F		
Output			
Analog output	0/4-20 mA / burden ≤500 Ω or 0-10 VDC / ≥10 kΩ, 16 bit		

Switching outputs	
Relay with change-over contacts Switching cycles	250 VAC / 5 AAC; 30 VDC / 5 ADC 30 x 10 ³ at 5 AAC, 5 ADC ohm resistive load 10 x 10 ⁶ mechanically Diversity according to DIN EN50178 / Characteristics according to DIN EN60255
PhotoMos outputs	8 normally open (NO) contacts 30 VDC/AC, 0,4 A
Interface	
Protocol	Modbus with ASCII or RTU-protocol
RS232	9.600 Baud, no parity, 8 databit, 1 stopbit, wire length max. 3 m
RS485	9.600 Baud, no parity, 8 databit, 1 stopbit, wire length max 1000 m
Power supply	
	100-240 VAC 50/60 Hz, DC ±10 % max. 15 VA 10-40 VDC galv. isolated, 18-30 VAC 50/60 Hz, max. 15 VA
Memory	
	EEPROM
Data life	≥ 100 years at 25°C
Ambient conditions	
Working temperature	0...50°C
Storing temperature	-20...80°C
Climatic density	relative humidity 0-80% on years average without dew
EMV	
	EN 61326, EN 55011
CE-sign	
	Conformity to directive 2014/30/EU
Safety standard	
	according to low voltage directive 2014/35/EU EN 61010; EN 60664-1

10. Safety advices

Please read the following safety advices and the assembly *chapter 2* before installation and keep it for future reference.

Proper use

The **IM3-1C-device** is designed for the evaluation and display of sensor signals.



Danger! Careless use or improper operation can result in personal injury and/or cause damage to the equipment.

Control of the device

The panel meters are checked before dispatch and sent out in perfect condition. Should there be any visible damage, we recommend close examination of the packaging. Please inform the supplier immediately of any damage.

Installation

The **IM3-1C-device** must be installed by a suitably **qualified specialist** (e.g. with a qualification in industrial electronics).

Notes on installation

- There must be no magnetic or electric fields in the vicinity of the device, e.g. due to transformers, mobile phones or electrostatic discharge.
- **The fuse rating of the supply voltage should not exceed a value of 0.5A N.B. fuse!**
- Do not install **inductive consumers** (relays, solenoid valves etc.) near the device and **suppress** any interference with the aid of RC spark extinguishing combinations or free-wheeling diodes.
- Keep input, output and supply lines separate from one another and do not lay them parallel with each other. Position “go” and “return lines” next to one another. Where possible use twisted pair. So, you receive best measuring results.
- Screen off and twist sensor lines. Do not lay current-carrying lines in the vicinity. Connect the **screening on one side** on a suitable potential equaliser (normally signal ground).
- The device is not suitable for installation in areas where there is a risk of explosion.
- Any electrical connection deviating from the connection diagram can endanger human life and/or can destroy the equipment.
- The terminal area of the devices is part of the service. Here electrostatic discharge needs to be avoided. Attention! High voltages can cause dangerous body currents.
- Galvanic isolated potentials within one complex need to be placed on a appropriate point (normally earth or machines ground). So, a lower disturbance sensibility against impacted energy can be reached and dangerous potentials, that can occur on long lines or due to faulty wiring, can be avoided.

11. Error elimination

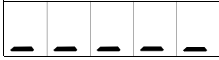
	Error description	Measures
1.	The unit permanently indicates overflow. 	<ul style="list-style-type: none"> The input has a very high measurement, check the measuring circuit. The input is open.
2.	The unit permanently shows underflow. 	<ul style="list-style-type: none"> The input has a very low measurement, check the measuring circuit. The input is open.
3.	The word <i>HELP</i> lights up in the 7-segment display.	<ul style="list-style-type: none"> The unit has found an error in the configuration memory. Perform a reset on the default values and reconfigure the unit according to your application.
4.	Program numbers for parameterising of the input are not accessible.	<ul style="list-style-type: none"> Programming lock is activated Enter correct code
5.	<i>ERR1</i> lights up in the 7-segment display.	<ul style="list-style-type: none"> Please contact the manufacturer if errors of this kind occur.
6.	The device does not react as expected.	<ul style="list-style-type: none"> If you are not sure if the device has been parameterised before, then follow the steps as written in <i>chapter 6</i> and set it back to its delivery status.
7.	The displayed temperature differs from the reference temperature.	<ul style="list-style-type: none"> Check if the right Pt100-type was selected under <i>TYPE</i>. Slightly differences can be corrected via the impedance matching <i>DIFF5</i>. If the parameter that needs to be compensated lies outside of $-10\dots 10^{\circ}\text{C}$ respectively $-18\dots 18^{\circ}\text{F}$, then you should search for a systematic error. If the available adjustment range is not sufficient, a fault in the test setup seems likely.

