

High-performance Intelligent 2-wire In-head Transmitters

Actual size

IPAQ-H^{PLUS} is a **high-performance**, universal and intelligent 2-wire In-head transmitter for temperature and other measurement applications.

IPAQ-HX^{PLUS} is the Intrinsic Safe version for use in Ex-applications.

The outstanding combination of **excellent specifications, high functionality and simple configuration** makes IPAQ-H^{PLUS} and IPAQ-HX^{PLUS} the obvious choice in **demanding applications**.

The Windows based and user friendly software, IPRO 4, is used for transmitter configuration, documentation, monitoring and calibration purposes.



Performance and design:

Precision accuracy

- Linearity 0.05 % for RTD.
- Reduced temperature influence. Each transmitter is individually temperature compensated.
- Long-term stability 0.05 %/year.

Fast response

- Update time down to 170 ms, i.e. a measuring frequency of appr. 6 per second.

Enhanced total system accuracy

- Sensor error correction (for known sensor errors).
- System error correction (against known temperatures).

NAMUR-compliant

- Output limitations and fail currents adjustable according to NAMUR recommendations.

Smart Filter

- Short response time combined with high noise immunity.

Input-Output isolation 3750 VAC

- Excellent filtering of voltage spikes and elimination of ground loops.

High load capacity

- Only 6.5 V voltage drop over the transmitter (IPAQ-H^{PLUS}) allows for high loads.

Designed for harsh conditions

- Operation temperature up to 85 °C / 185 °F (105 °C / 221 °F on request).
- Excellent EMC performance.
- Durable, shockproof design.

5 year limited warranty

Functions:

Input for RTDs, T/Cs, mV and resistance

- Reduced inventory costs.
- Simplified plant engineering.

True on-line communication

- Full access to all features while in operation.

Configuration without external power

- Editing or reading a configuration is possible also without external power supply.

Display connection

- Direct connection of an Inor digital display to the communication port.

Efficient customized 40-point linearization

- Any sensor characteristics can be matched.

Sensor diagnostics

- SmartSense detects low sensor isolation (essential for correct measurements).
- Selectable sensor break action.

Simplified loop check-up

- The transmitter works as an accurate current generator with user defined action.

On-screen indications and line recording

- Valuable tools for temporary measurements.

Improved QA with data storage

- Vital information, such as TAG-No., maintenance record etc. can be stored in the nonvolatile memory.

Accuracy and stability

IPAQ-H^{PLUS}/IPAQ-HX^{PLUS} are designed for applications with the highest demands on accuracy, also under severe operating conditions. To reach these demands, the following factors are essential:

Low linearity and calibration errors -The combination of a high-efficient 40-point linearization and the use of quality components and precision calibration equipment reduce these errors to a minimum, e.g. ±0.05 % of span for RTD inputs.

Low ambient temperature influence -Each transmitter in the IPAQ^{PLUS} family is individually compensated at different temperatures within the operating range. This procedure minimizes the ambient influence to a minimum.

High long-term stability -Internal “self calibration”, by means of continuous adjustment of important parameters after comparison with accurate built-in references, contributes to a stability better than ±0.05 %/year.

Measurements with RTDs and other resistances

IPAQ-H^{PLUS}/IPAQ-HX^{PLUS} accept inputs from standardized Platinum and Nickel RTDs like Pt10...Pt1000 acc. to IEC 751 (α=0.00385), Pt100 acc. to JIS 1604 (α=0.003916) and Ni100/Ni1000 acc. to DIN 43760, as well as inputs from plain resistance sensors such as potentiometers. 3- or 4-wire connection can be chosen.

Measurements with thermocouples and plain voltage

IPAQ-H^{PLUS}/IPAQ-HX^{PLUS} accept inputs from 11 types of standardized thermocouples as well as plain mV input. For T/C input, the CJC (Cold Junction Compensation) is fully automatic, by means of an accurate measurement of the terminal temperature. Alternatively, an external CJ temperature can be entered.

Digital output for display

Direct connection to external Inor display through the communication port. The information on the display is defined when programming the transmitter. *Request display information.*

Customized linearization and Engineering units

The accurate and versatile 40-point *Customized linearization* can be used to create any type of linearization curve for RTD, T/C, resistance and mV inputs. By combining *Customized linearization* with the use of *Engineering units*, the transmitters can be programmed to give a linear output corresponding to a specific measuring range expressed in the primary process value. The sensor characteristics are described by either up to 40 data pairs or 8 polynomials. *Fig. 1a and 1b.*

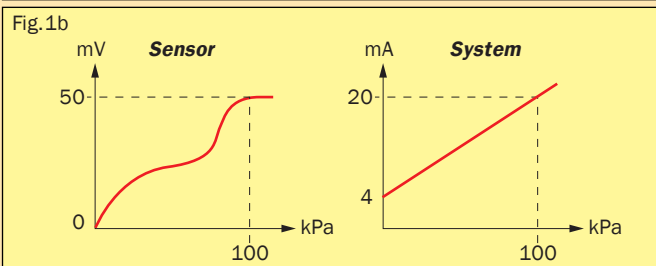
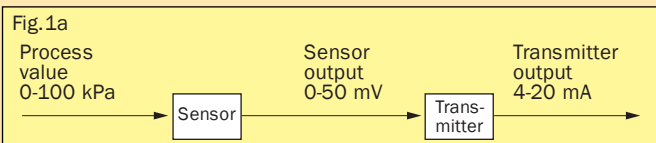

Exemple of a system (sensor + transmitter) with an output linear to the process value, in spite of a non-linear sensor.

Sensor or System error correction

IPAQ-H^{PLUS}/IPAQ-HX^{PLUS} offer two ways of improving the measurement with temperature sensors:

Sensor error correction - Known sensor errors compared to the standard curve, e.g. for a calibrated sensor, are entered, and the transmitter automatically corrects for the sensor errors. *Fig. 2.*

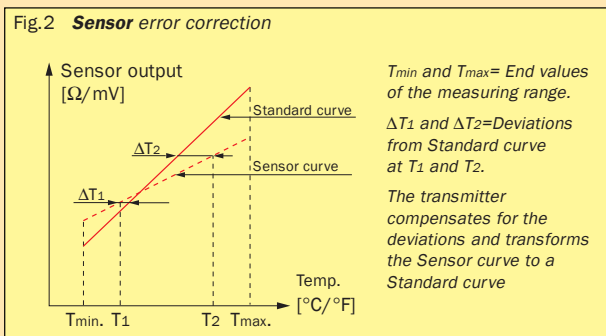

System error correction -This method is used to correct the system error (sensor + transmitter error) by exposing the sensor to one (one-point correction) or two (two-point correction) accurately measured temperatures (true temperatures). The true temperature(s) and the corresponding transmitter reading(s) are entered, and the transmitter automatically corrects for the system errors. *Fig. 3.*

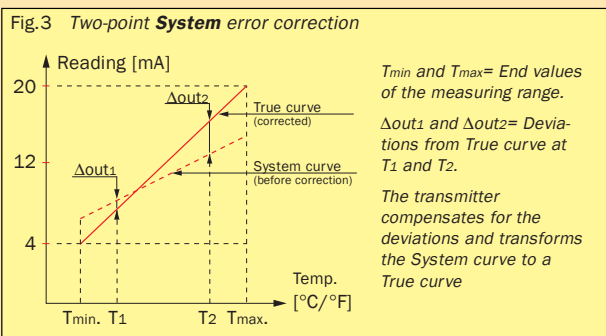

SmartSense - Sensor isolation monitoring

SmartSense continuously monitors the isolation resistance of thermocouples and 3-wire connected RTDs as well as the cabling between sensor and transmitter. The transmitter will react by forcing the output to a user defined level if the isolation is below a preset level. SmartSense requires an extra lead inside the thermocouple or RTD. *Fig. 4.*

For detailed information, see section Theory and Facts.

Sensor break monitoring

IPAQ-H^{PLUS}/IPAQ-HX^{PLUS} monitor sensor break and force the output signal to a user defined level, when any sensor lead is broken or disconnected. The sensor break monitoring can be switched off. The monitoring is furnished with a pulsed excitation current. This eliminates the voltage drop in the lead wires (giving a measuring error), caused by a standard DC excitation current.

Controlled output for instrument calibration

IPAQ-H^{PLUS}/IPAQ-HX^{PLUS} can be set to automatically provide fixed or recurring output current regardless of the input signal. The time periods in recurring mode are selectable.

Smart Filter

The Smart Filter detects the difference between fast signal changes and electrical noise, e.g. ripple and spikes, on the input. The smart filter offers a superior combination of very short response time for the input signal and high noise immunity.

Adjustable dampening

The dampening function can be used to dampen undesired instabilities on the input signal. The dampening time can be set between 0 and 10 seconds in intervals of 1 second. The dampening time is the time required, in addition to the update time, for the output to reach 90% of its final value after a step change has been applied to the input.

NAMUR-compliant

The output can be limited to high and low selectable values, i.e. $3.8 \leq I \leq 20.5$ mA for NAMUR compliance. This function is overridden by the Sensor break monitoring and SmartSense.

Power supply

IPAQ-H^{PLUS}/IPAQ-HX^{PLUS} are loop-powered and will work on voltages down to 6.5 VDC (8 VDC for IPAQ-HX^{PLUS}), thus allowing for high loads in the current loop. Reversed polarity will not damage the transmitter. Fig. 5

Mounting

IPAQ-H^{PLUS}/IPAQ-HX^{PLUS} are designed to fit inside connection heads type DIN B or larger. The 7mm/0.28 inch center hole facilitates the mounting procedure.

IPRO 4 - The user friendly software for all transmitters of the IPAQ family

IPRO 4, which is used with all IPAQ-transmitters, is the tool to utilize all the versatile functions of the IPAQ-H^{PLUS} and IPAQ-HX^{PLUS} such as:

- Measurement configuration: Sensor type, range, sensor or system error correction, linearization, engineering units, output settings, filter activation, etc.
- Monitoring of sensor status: Sensor break and sensor isolation (SmartSense).
- On-screen real time presentation of measured values and output signal in the form of numericals, meters, bar graphs and line recorder.
- Transmitter calibration: Field calibration in one or two points and basic calibration.
- Documentation: Configuration files can be saved for future use and configuration protocols can easily be printed.

The communication with the transmitter can be performed on line, i.e. with transmitter in operation.

IPAQ-H^{PLUS}/IPAQ-HX^{PLUS} can also be configured without connecting a power supply.

An isolated and Ex-approved communication cable is included in the software kit, IPRO-X.

IPRO 4 is compatible with Windows 3.1, Windows 3.11, Windows 95 and Windows NT Workstation 4.0. The program is menu-driven and easy to learn. On-line help is an effective tool for the user.

Warranty

IPAQ-H^{PLUS}/IPAQ-HX^{PLUS} are covered by a 5 year limited warranty.

IPAQ-H^{PLUS}/IPAQ-HX^{PLUS} Configuration scheme

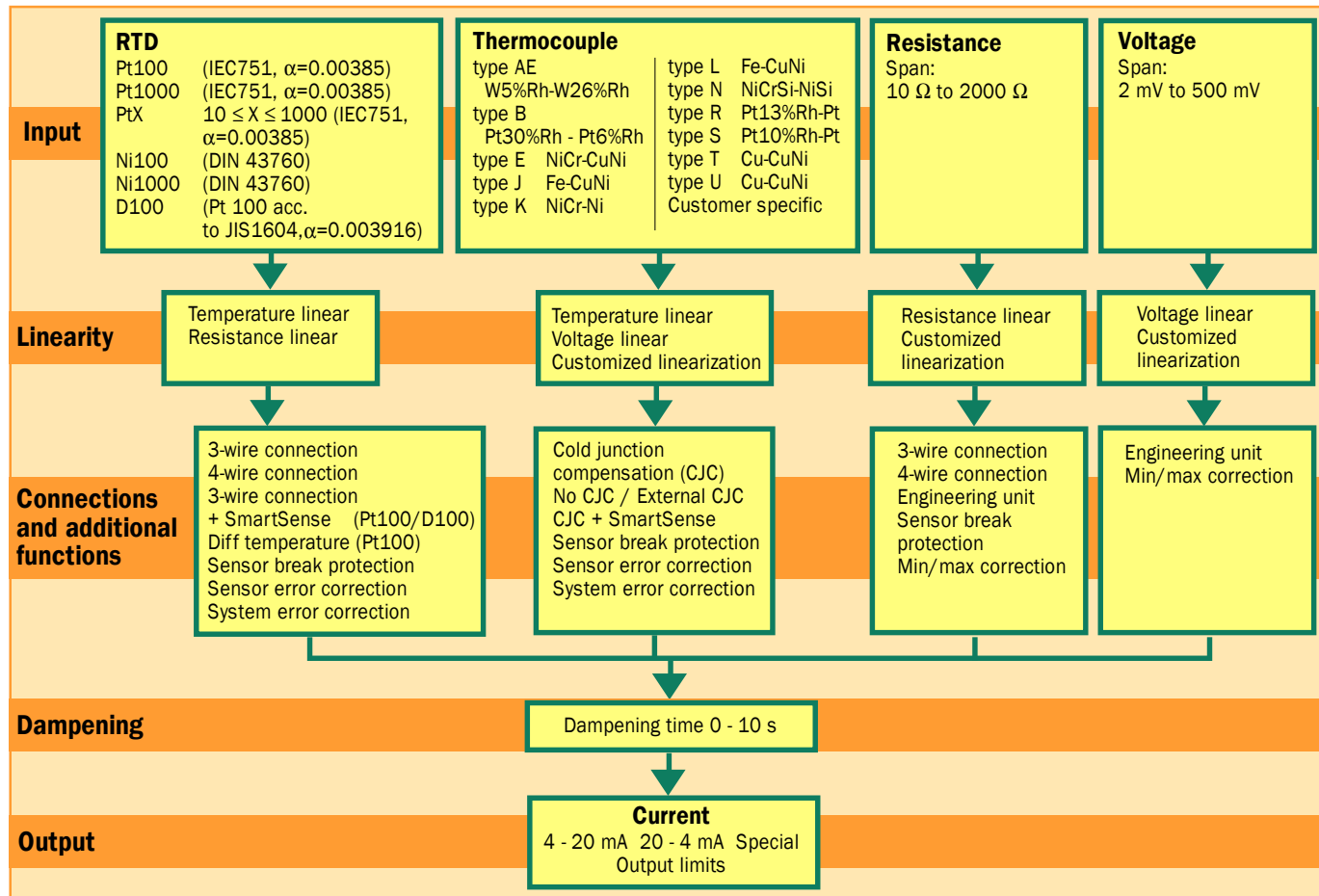

Specifications

Input		
RTD's and Resistance		
Pt100 (IEC751, $\alpha=0.00385$)	3-, 4-wire connection	-200 to +1000 °C / -328 to +1832 °F
Pt1000 (IEC751, $\alpha=0.00385$)	3-, 4-wire connection	-200 to +200 °C / -328 to +392 °F
PtX $10 \leq X \leq 1000$ (IEC751, $\alpha=0.00385$)	3-, 4-wire connection	Upper range depending on X-value
Ni100 (DIN 43760)	3-, 4-wire connection	-60 to +250 °C / -76 to +482 °F
Ni1000 (DIN 43760)	3-, 4-wire connection	-60 to +150 °C / -76 to +302 °F
D100 (Pt 100 acc.to JIS1604, $\alpha=0.003916$)	3-, 4-wire connection	-200 to +1000 °C / -328 to +1832 °F
Potentiometer/resistance	3-, 4-wire connection	0 to 2000 Ω
Sensor current		~ 0.4 mA
Maximum sensor wire resistance		25 Ω /wire
Thermocouples and Voltage		
T/C	Type: AE, B, E, J, K, L, N, R, S, T, U	Ranges according to users manual
Voltage input		-10 to +500 mV
Input impedance		>10 M Ω
Maximum sensor wire resistance		500 Ω (total loop)
Monitoring		
Sensor break monitoring	User definable output	3.5 to 22.8 mA ¹⁾
SmartSense, sensor isolation monitoring	User definable output	3.5 to 22.8 mA ¹⁾
Adjustments		
Zero adjustment	All inputs	Any value within range limits
Minimum spans	Pt100, Pt1000, Ni100, Ni1000	10 °C / 18 °F
	Potentiometer	10 Ω
	T/C, mV	2 mV
Output		
Straight, reversed or any intermediate value		4-20/20-4 mA
Resolution		5 μ A
Minimum output signal	Adjustable	≥ 3.5 mA
Maximum output signal	Adjustable	≤ 22.8 mA
Permissible load, <i>see fig.5</i>	IPAQ-H ^{PLUS}	760 Ω @ 24 VDC, 23 mA
	IPAQ-HX ^{PLUS}	695 Ω @ 24 VDC, 23 mA ²⁾
Temperature		
Ambient, storage		-40 to +85 °C / -40 to +185 °F ⁴⁾
Ambient, operation	IPAQ-H ^{PLUS}	-40 to +85 °C / -40 to +185 °F ⁴⁾
	IPAQ-HX ^{PLUS}	Acc. to Ex-approval (pending)
General data		
Adjustable dampening time		0 to 10 s
Update time		~170 ms ³⁾
Isolation In - Out		3750 VAC, 1 min
Humidity (non-condensing)		0 to 95 %RH
Intrinsic safety	IPAQ-HX ^{PLUS} , Cenelec	Approval pending
	FM	Approval pending
Power supply, polarity protected		
Supply voltage	IPAQ-H ^{PLUS}	6.5 to 36 VDC 2-wire
	IPAQ-HX ^{PLUS}	8.0 to 30 VDC ²⁾ 2-wire
Permissible ripple		4 V p-p @ 50/60 Hz

¹⁾ Independent of output limitation

²⁾ Preliminary data

³⁾ ~300 ms with Sensor Break Monitoring activated

⁴⁾ Up to 105 °C/221 °F available on request

Accuracy		
Linearity	RTD Potentiometer, mV	±0.05 % ¹⁾
	T/C	±0.1 % ¹⁾
Calibration	RTD	Max. of ±0.1 °C / ±0.2 °F or ±0.05 % ¹⁾
	Potentiometer	Max. of ±0.1 Ω or ±0.05 % ¹⁾
Cold Junction Compensation (CJC)	mV, T/C	Max. of ±20 μV or ±0.05 % ¹⁾
	T/C	±0.5 °C / ±0.9 °F
Temperature influence ⁴⁾	All inputs	Max. of ±0.125 °C/25 °C or ±0.125%/25 °C ¹⁾³⁾
		Max. of ±0.25 °F/50 °F or ± 0.14%/50 °F ¹⁾³⁾
Temperature influence CJC ⁴⁾	T/C	±0.5 °C/25 °C / ±1.0 °F/50 °F
Instrument calibration output	4-20 mA	±4.5 μA
Sensor wire resistance influence	RTD, Potentiometer, 3-wire	Negligible ²⁾
	RTD, Potentiometer, 4-wire	Negligible
	mV, T/C	Negligible
Load influence		Negligible
Power supply influence		Negligible
RFI influence, 0.15-1000 MHz, 10 V or V/m		±0.1 % ¹⁾ (typical)
Long-term stability		±0.05 % ¹⁾ /year
Housing		
Material / Flammability (UL)		PC + ABS/V0, Polyamide/V2
Mounting		DIN B-head or larger, DIN rail (with mounting kit)
Connection	Single/stranded wires	≤1.5 mm ² , AWG 16
Weight		50 g
Protection, housing / terminals		IP 50 / IP 10

¹⁾ Of input span

²⁾ With equal wire resistance

³⁾ If zero-deflection > 100% of input span:
add 0.125% of input span/25 °C or 0.14%
of input span/50 °F per 100% zero-deflection

⁴⁾ Reference temperature 23 °C/73 °F

The User Instructions must be read prior to adjustment and/or installation.

Accuracy examples

Applications	Partial accuracies (°C)					Total statistical accuracy	
	Linearity	Calibration	CJC	Temperature influence	Temperature influence CJC	°C ⁵⁾	% of span
Pt100, 0-200 °C, T _{Amb} = 25°C	±0.1	±0.1	–	±0.02	–	±0.14	±0.07
Pt100, 0-200 °C, T _{Amb} = 50°C	±0.1	±0.1	–	±0.27	–	±0.30	±0.15
T/C K, 0-600 °C, T _{Amb} = 25°C	±0.6	±0.3	±0.5	±0.06	±0.04	±0.84	±0.14
T/C K, 0-600 °C, T _{Amb} = 50°C	±0.6	±0.3	±0.5	±0.81	±0.54	±1.28	±0.21

Reference temperature: T_{Amb} = 23 °C

⁵⁾ Total statistical accuracy (Δ_{Tot}) is calculated as the "Root Mean Square" of the partial accuracies (Δ₁...Δ_n)

$$\Delta_{Tot} = \sqrt{\Delta_1^2 + \Delta_2^2 + \dots + \Delta_n^2}$$

INPUTS

RTD

Pt100, Pt1000, Ni100, Ni1000, PtX, D100
4-wire connection

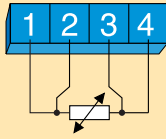

3-wire connection

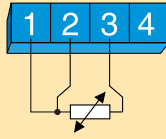

Pt100, D100
3-wire connection

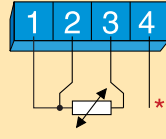

*SmartSense lead

Pt100
Diff temperature $T_1 > T_2$

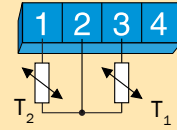

Potentiometer

4-wire connection

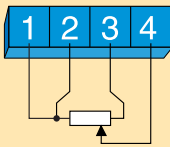

3-wire connection

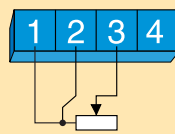

Voltage

millivolt

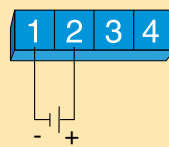

Thermocouple

AE, B, E, J, K, L, N, R, S, T, U
or customer specific

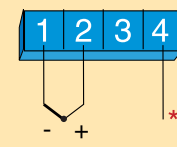

*SmartSense lead

OUTPUT

4-20 mA Output

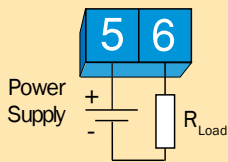

Connections

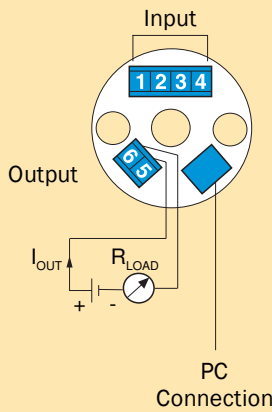

Dimensions

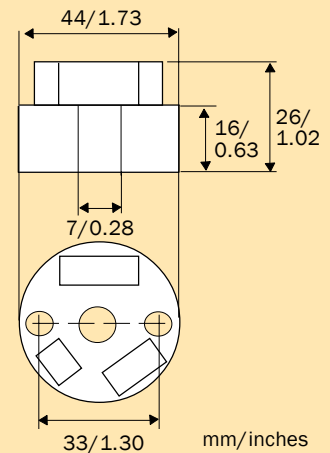

SmartSense

Fig.4

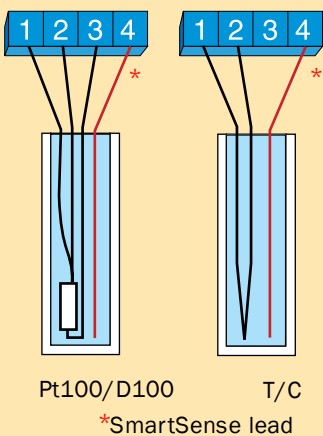

*SmartSense lead

Output load diagram

Fig.5

Permissible R_{Load} at 23 mA output
 R_{Load} (Ω)

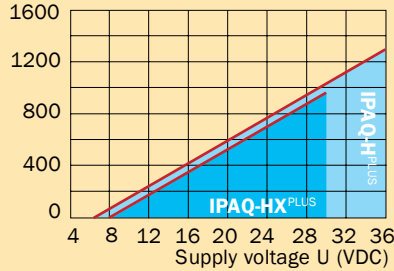

$$R_{Load} = (U - 6.5) / 0.023 \text{ (IPAQ-H}^{PLUS}\text{)}$$

$$R_{Load} = (U - 8.0) / 0.023 \text{ (IPAQ-HX}^{PLUS}\text{)}$$

Ordering table

Item	Part No.
Transmitter	
IPAQ-H ^{PLUS}	701PHPO001
IPAQ-HX ^{PLUS} (Cenelec)	701PHPX001
IPAQ-HX ^{PLUS} (FM)	701PHPX101
Options	
Configuration	70CAL00001
Configuration with 5-point calibration certificate	70CAL00051
Software and cable	
IPRO-X (IPRO with cable)	70IPRX0001
Software IPRO upgrade	70IPRS0001
Accessories	
Surface mounting box	70ADA00008
Rail mounting box	70ADA00009
Head mounting kit	70ADA00012
Rail mounting kit	70ADA00013