

HART® Compatible Intelligent 2-wire In-head Transmitters



Actual size



MESO-H is a *Smart* and universal 2-wire In-head transmitter for temperature and other measurement applications.

MESO-HX is the Intrinsic Safe version for use in Ex-applications.

MESO-H and MESO-HX are *fully HART-compatible*, with communication through the HART protocol, directly on the 4-20 mA output loop, by using either a general hand-held HART Communicator or the Inor PC software, MEPRO 2.

MEPRO 2 is a Windows based and user friendly software, which facilitates the access to and use of functions like transmitter configuration, documentation, monitoring and calibration.

Performance and design:

Excellent stability

- Long-term stability 0.1 %/year.

Enhanced total system accuracy

- Sensor error correction (compensates for known sensor errors).

Input-Output isolation 1500 VAC

- Eliminates measuring errors due to ground loops.

High load capacity

- Only 10 V voltage drop over the transmitter (MESO-H) allows for high loads.

Designed for harsh conditions

- Operation temperature: up to 85 °C / 185 °F (105 °C / 221 °F on request)
- Excellent EMC performance.
- Durable, shockproof design.

Simple mounting and connection

- For DIN B head or larger.
- Large center hole (dia. 7 mm / 0.28 inch).

5 year limited warranty

Functions:

Fully HART® Compatible

- True on-line communication with hand-held HART Communicator or Windows software MEPRO 2.

Input for RTDs, T/Cs, mV and resistance

- Reduced inventory costs.
- Simplified plant engineering.

Efficient customized 50-point linearization

- Any sensor characteristics can be matched.

Sensor diagnostics

- SmartSense detects low sensor isolation (essential for correct measurements).
- Selectable sensor break action.

Simplified loop check-up

- The transmitter works as an accurate current generator.

On-screen indications of input and output

- Valuable tools for temporary measurements.

Improved QA with data storage

- Vital information, such as TAG-No., maintenance record etc. can be stored in the nonvolatile memory.

Main features of MESO-H and MESO-HX

Accuracy and stability

MESO-H/MESO-HX are designed for applications with high demands on accuracy, also under severe operating conditions. To reach these demands, the following factors are essential:

Linearity and calibration errors - The combination of an efficient linearization function and the use of quality components and precision calibration equipment reduce these errors to $\pm 0.1\%$ of span.

Ambient temperature influence - The transmitters in the MESO family are compensated to reduce the ambient temperature influence to low levels.

High long-term stability - Internal "self calibration", by means of continuous adjustment of important parameters after comparison with accurate built-in references, contributes to a stability of $\pm 0.1\%$ / year.

Measurements with RTDs and other resistances

MESO-H/MESO-HX accept inputs from standardized Platinum and Nickel RTDs like Pt10...Pt1000 acc. to IEC 751 ($a=0.00385$), Pt100 acc. to JIS 1604 ($a=0.003916$) and Ni100 / Ni1000 acc. to DIN 43760, as well as inputs from plain resistance sensors such as potentiometers.

3- or 4-wire connection can be chosen.

Measurements with thermocouples and plain voltage

MESO-H/MESO-HX accept inputs from 11 types of standardized thermocouples as well as plain mV input.

For T/C input, the CJC (Cold Junction Compensation) is fully automatic, by means of an accurate measurement of the terminal temperature. Alternatively, the CJC can be disabled.

Sensor error connection

MESO-H/MESO-HX offer a way of improving the measurement with temperature sensors:

Known sensor errors compared to the standard curve, e.g. for a calibrated sensor, are entered, and the transmitter automatically corrects for the sensor errors. Fig. 1.

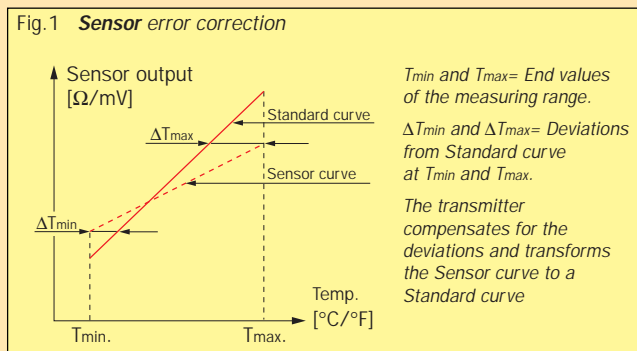

Customized linearization and Engineering units

The accurate and versatile 50-point *Customized linearization* can be used to create almost any type of linearization curve for RTD, T/C, resistance and mV inputs. By combining *Customized linearization* with the use of *Engineering units*, the transmitters can be programmed to give a linear output corresponding to a specific measuring range expressed in the primary process value.

The sensor characteristics are described by either up to 50 data pairs or a third order polynomial. Fig. 2a and 2b.

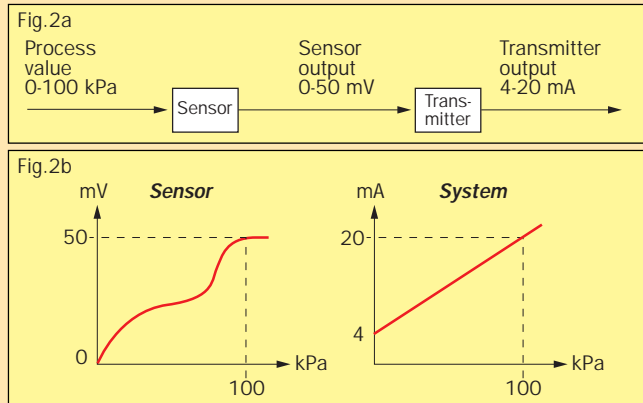

Example of a system (sensor + transmitter) with an output *linear* to the process value, in spite of a *non-linear* sensor.

SmartSense - Sensor isolation monitoring

SmartSense continuously monitors the isolation resistance of thermocouples and 3-wire connected RTDs as well as the cabling between sensor and transmitter. The transmitter will react by forcing the output to a user defined level if the isolation level is too low. SmartSense requires an extra lead inside the thermocouple or RTD. Fig. 7.

For detailed information, see section *Theory and Facts*.

Sensor break monitoring

MESO-H/MESO-HX monitor sensor break and force the output signal to a user defined level, when *any* sensor lead is broken or disconnected. The sensor break monitoring can be switched off. The monitoring is furnished with a *pulsed excitation current*. This eliminates the voltage drop in the lead wires (giving a measuring error), caused by a standard DC excitation current.

Controlled output for instrument calibration

With MEPRO 2, MESO-H/MESO-HX can be set to automatically provide the recurring output values of 4, 12, 20, 12, 4 mA in a periodical scheme. Each level will last 15 seconds. The total time for controlled output is adjustable up to 30 minutes. With the hand-held Hart Communicator model 275, a constant transmitter output can be set at any level between 4 and 20 mA.

Adjustable dampening

The dampening function can be used to dampen undesired instabilities on the input signal. The dampening time can be set to values between 0 and 10 seconds in intervals of 1 second. The dampening time is the time required, in addition to the update time, for the output to reach 90% of its final value after a step change has been applied to the input.

Power supply

MESO-H/MESO-HX are loop-powered and will work on voltages down to 10 VDC (12 VDC for MESO-HX). Reversed polarity will not damage the transmitter.

Since the HART communication requires a loop resistance of at least 250 Ω , the minimum power supply is 15.75 VDC for MESO-H and 17.75 VDC for MESO-HX.

The relation between supply voltage and permissible load in the output loop is shown in fig. 8

Mounting

MESO-H/MESO-HX are designed to fit inside connection heads type DIN B or larger.

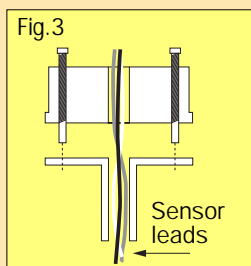

The large center hole, dia. 7 mm / 0.28 inch, facilitates the pulling through of the sensor leads or an insert tube, greatly simplifying the mounting procedure.
Fig. 3.

Output cabling

MESO-H/MESO-HX allow for long output cables. The length is determined by the combination of the cable capacitance, the cable resistance, and the load resistance. Fig. 4.

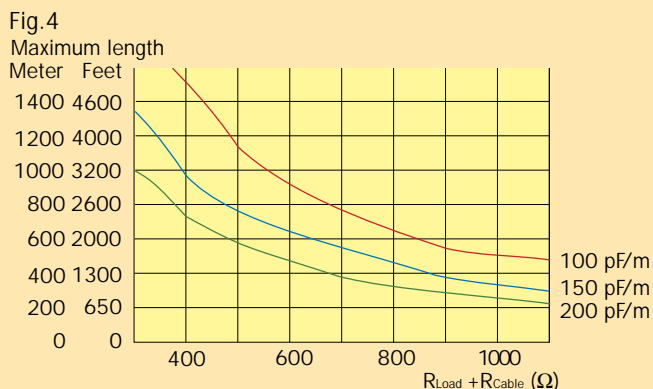

Warranty

MESO-H/MESO-HX are covered by a 5 year limited warranty.

The HART Concept

HART® is a master-slave concept where compatible instruments like MESO-H/MESO-HX are the slave devices. The master can be either a PC with the INOR MEPRO 2 software and a HART modem, or the hand-held HART Communicator, model 275.

The HART protocol uses the very robust FSK (*Frequency Shift Keying*) communication method. The frequency signal is superimposed on the 4-20 mA signal as a near sinus-shaped waveform. The average value of the superimposed signal is 0, and therefore, it will not interfere with the 4-20 mA signal.

For a more detailed explanation of the HART concept, the reader is referred to "A Technical Overview", published by the HART Communication Foundation.

Standard mode

In the standard mode, the 4-20 mA output is active, and the master is connected anywhere across the output leads. Please note, that there must be a resistance of at least 250 Ω between the connection point and the power supply for safe HART communication. The total loop resistance (load + cable) should not exceed 1100 Ω. Fig. 6.

Multidrop mode

In multidrop mode, the 4-20 mA output is not used (locked to 4 mA). A maximum of 15 units in the same loop can communicate digitally with the master. Each unit will only reply to messages directed to its personal address. The message rate is 2-3 complete messages per second. Fig. 5.

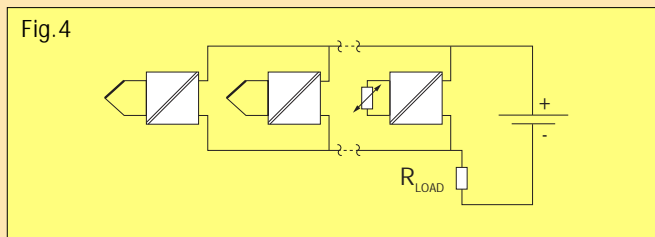

Communicating with PC and MEPRO 2 software

MEPRO 2, which is used with all MESO-transmitters, is the best tool to utilize all the versatile functions of the MESO-H/MESO-HX such as:

- Measurement configuration: sensor type, range, sensor error correction, linearization, engineering units, output settings, filter activation, etc.
- Monitoring of the sensor status: Sensor break and sensor isolation (SmartSense).
- Transmitter diagnostics.
- On-screen real time presentation of measured values and output signal.
- Transmitter basic calibration.
- Documentation: Configuration files can be saved for future use and configuration protocols can easily be printed.

MEPRO 2 is compatible with Windows 3.1, Windows 3.11 and Windows 95. The program is menu-driven and easy to use. On-line help is an effective tool for the user.

Communicating with HART Communicator

In a system with different HART compatible units, the HART Communicator, model 275, offers a great advantage. When connected to the current loop, the device automatically recognizes the slave's make and model and is directly ready to communicate. The HART Communicator can reach all functions within the MESO-H/MESO-HX (except for the Customized Linearization with data pairs and transmitter calibration).

The software of the HART Communicator must include the DD (Device Description) for MESO. New devices delivered as of July, 1997, normally include the DD for MESO, and older communicators can easily be upgraded by the supplier of the device.

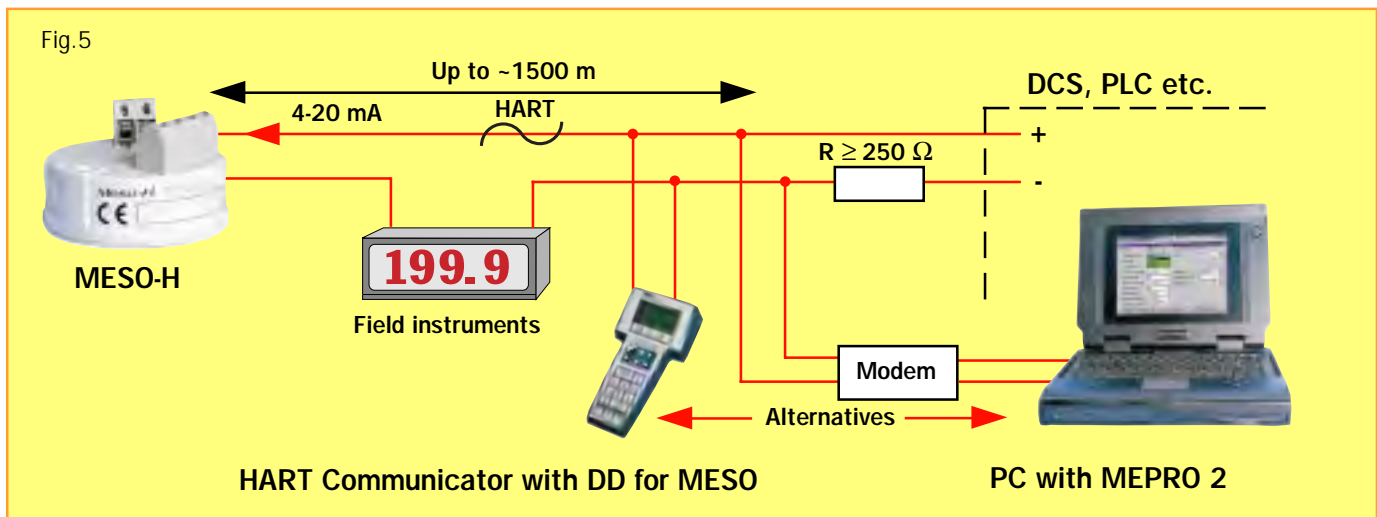

Typical "Standard Mode" installation. Special requirements for Hazardous Locations (see Conformity Certificates).

HART is registered trademark of HART Communication Foundation.

MESO-H/MESO-HX Configuration scheme

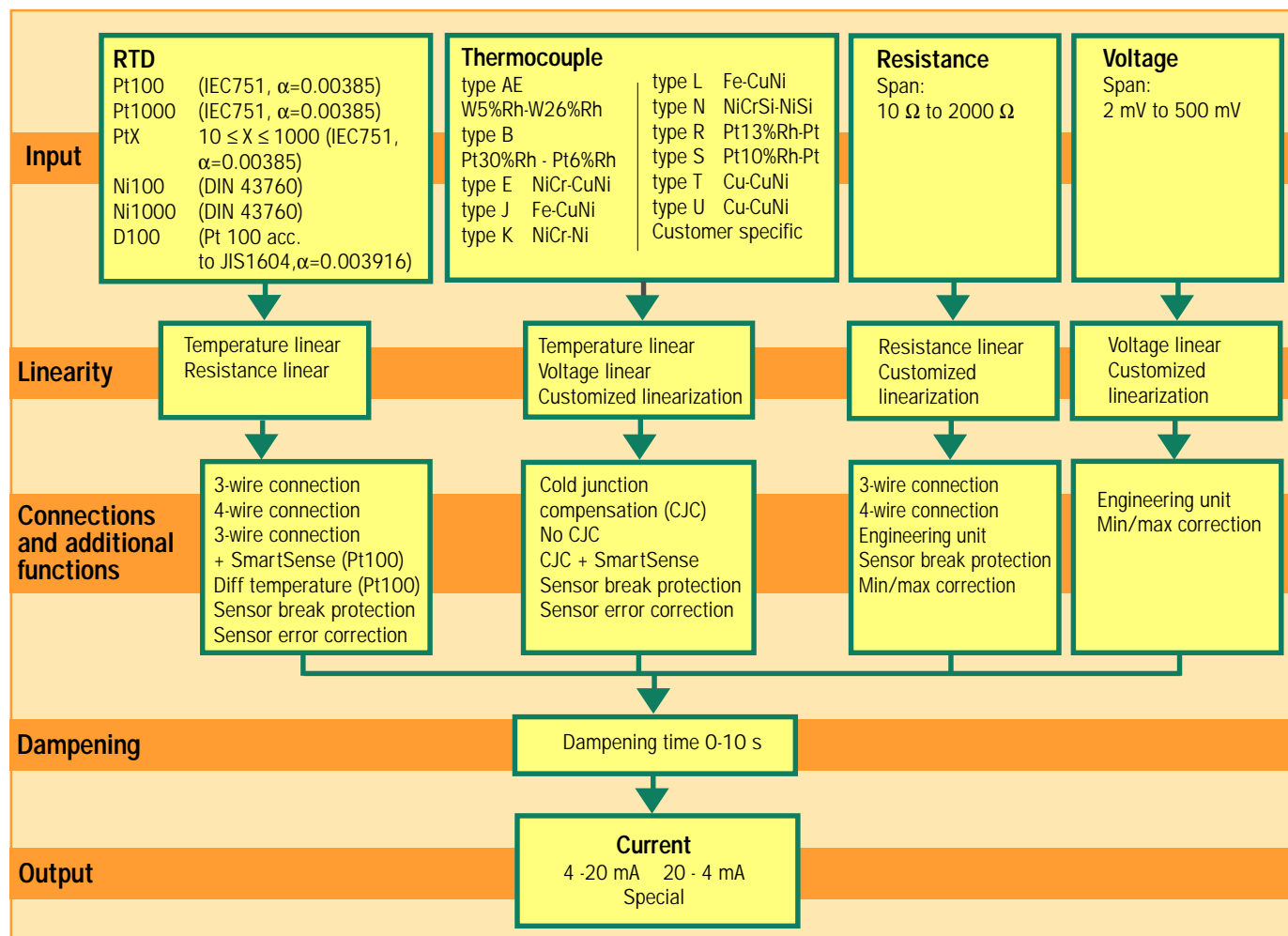

Specifications

Input		
RTD's and Resistance		
Pt100 (IEC751, $\alpha = 0.00385$)	3-, 4-wire connection	-200 to +1000 °C / -328 to +1832 °F
Pt1000 (IEC751, $\alpha = 0.00385$)	3-, 4-wire connection	-200 to +200 °C / -328 to +392 °F
PtX $10 \leq X \leq 1000$ (IEC751, $\alpha = 0.00385$)	3-, 4-wire connection	Upper range depending on X-value
Ni100 (DIN 43760)	3-, 4-wire connection	-60 to +250 °C / -76 to +482 °F
Ni1000 (DIN 43760)	3-, 4-wire connection	-60 to +150 °C / -76 to +302 °F
D100 (Pt 100 acc.to JIS1604, $\alpha = 0.003916$)	3-, 4-wire connection	-200 to +1000 °C / -328 to +1832 °F
Potentiometer/resistance	3-, 4-wire connection	0 to 2000 Ω
Sensor current		~ 0.4 mA
Maximum sensor wire resistance		25 Ω /wire
Thermocouples and Voltage		
T/C	Type: AE, B, E, J, K, L, N, R, S, T, U	Ranges according to users manual
Voltage input		-10 to +500 mV
Input impedance		>10 M Ω
Maximum sensor wire resistance		500 Ω (total loop)
Monitoring		
Sensor break monitoring	User definable output	3.6 to 22.8 mA
SmartSense, sensor isolation monitoring	User definable output	3.6 to 22.8 mA
Adjustments		
Zero adjustment	All inputs	Any value within range limits
Minimum spans	Pt100, Pt1000, Ni100, Ni1000	10 °C / 18 °F
	Potentiometer	10 Ω
	T/C, mV	2 mV
Output		
Straight, reversed or any intermediate value		4-20/20-4 mA
Resolution		5 μ A
Minimum output signal		~ 3.6 mA
Maximum output signal		~ 23 mA
Permissible load, <i>see fig.8</i>	MESO-H	610 Ω @ 24 VDC, 23 mA ¹⁾
	MESO-HX	520 Ω @ 24 VDC, 23 mA ¹⁾
Temperature		
Ambient, storage		-40 to +85 °C / -40 to +185 °F
Ambient, operation	MESO-H	-40 to +85 °C / -40 to +185 °F
	MESO-HX	See Intrinsic Safety Specifications
General data		
Adjustable dampening time		0 to 10 s
Update time		~ 0.8 s ⁵⁾
Isolation In - Out		1500 VAC, 1 min
Humidity (non-condensing)		0 to 95 %RH
Intrinsic safety	MESO-HX, ATEX	II 1 G EEx ia IIC T4, T5, T6
	FM	Class I, II and III Div. 1, Group A-D, G
Power supply, polarity protected		
Supply voltage	MESO-H	10 to 42 VDC 2-wire ²⁾
	MESO-HX	12 to 30 VDC 2-wire ²⁾
Permissible ripple		2 V p-p @ 50/60Hz ³⁾

¹⁾ Higher load permitted with higher supply voltage (see fig. 8).
Minimum 250 Ω required for HART communication.

²⁾ With 250 Ω in the output loop, a minimum of 15.75 VDC (MESO-H) or 17.75 VDC (MESO-HX) is required.

³⁾ For detailed information about permissible noise, we refer to the HART specification HCF-SPEC-54.

⁴⁾ Up to 105 °C/221 °F available on request.

⁵⁾ ~1.5 s with Sensor Break Monitoring activated

Accuracy

Linearity	RTD Potentiometer, mV	$\pm 0.1\%$ ¹⁾
	T/C	$\pm 0.1\%$ ¹⁾
Calibration	RTD	Max. of $\pm 0.2\text{ }^{\circ}\text{C}$ / $\pm 0.4\text{ }^{\circ}\text{F}$ or $\pm 0.1\%$ ¹⁾
	Potentiometer	Max. of $\pm 0.1\ \Omega$ or $\pm 0.1\%$ ¹⁾
	mV, T/C	Max. of $\pm 20\ \mu\text{V}$ or $\pm 0.1\%$ ¹⁾
Cold Junction Compensation (CJC)	T/C	$\pm 0.5\text{ }^{\circ}\text{C}$ / $\pm 0.9\text{ }^{\circ}\text{F}$
Temperature influence ⁴⁾	All inputs	Max. of $\pm 0.25\text{ }^{\circ}\text{C}/25\text{ }^{\circ}\text{C}$ or $\pm 0.25\%/25\text{ }^{\circ}\text{C}$ ¹⁾³⁾
		Max. of $\pm 0.5\text{ }^{\circ}\text{F}/50\text{ }^{\circ}\text{F}$ or $\pm 0.28\%/50\text{ }^{\circ}\text{F}$ ¹⁾³⁾
Temperature influence CJC ⁴⁾	T/C	$\pm 0.5\text{ }^{\circ}\text{C}/25\text{ }^{\circ}\text{C}$ / $\pm 1.0\text{ }^{\circ}\text{F}/50\text{ }^{\circ}\text{F}$
Instrument calibration output	4-20 mA	$\pm 8\ \mu\text{A}$
Sensor wire resistance influence	RTD, Potentiometer, 3-wire	Negligible ²⁾
	RTD, Potentiometer, 4-wire	Negligible
	mV, T/C	Negligible
Load influence		Negligible
Power supply influence		Negligible
RFI influence, 0.15-1000 MHz, 10 V or V/m		$\pm 0.2\%$ ¹⁾ (typical)
Long-term stability		$\pm 0.1\%$ ¹⁾ /year

Housing

Material / Flammability (UL)		PC + ABS/V0, Polyamide/V2
Mounting		DIN B-head or larger, DIN rail (with mounting kit)
Connection	Single/stranded wires	$\leq 1.5\text{ mm}^2$, AWG 16
Weight		50 g
Protection, housing / terminals		IP 50 / IP10

The User Instructions must be read prior to adjustment and/or installation.

¹⁾ Of input span

²⁾ With equal wire resistance

³⁾ If zero-deflection > 100% of input span:
add 0.125 % of input span/ $25\text{ }^{\circ}\text{C}$ or 0.14 %
of input span/ $50\text{ }^{\circ}\text{F}$ per 100 % zero-deflection

⁴⁾ Reference temperature $23\text{ }^{\circ}\text{C}$ / $73\text{ }^{\circ}\text{F}$

Intrinsic Safety specifications

Specifications	MESO-HX	MESO-HX
Approval	Demko / ATEX	Factory Mutual (FM)
Classification	II 1 G EEx ia IIC T4, T5, T6 T4/+85 °C, T5/+65 °C, T6/+50 °C	IS for use in CL I, II and III, DIV 1, GP A-D, G, T4 Ta=80 °C
Certificate No.	DEMKO 03 ATEX 1340 77X	J.I. 6D9A4. AX, Drw. 3-7967
Output/Supply		
Max voltage to transmitter	$U_i = 30\text{ Vdc}$	$V_{\text{max}} = 30\text{ V}$
Max current to transmitter	$I_i = 100\text{ mA}$	$I_{\text{max}} = 100\text{ mA}$
Max power to transmitter	$P_i = 900\text{ mW}$	$P_{\text{max}} = 900\text{ mW}$
Internal inductance	$L_i = 1\text{ mH}$	$L_i = 0\text{ mH}$
Internal capacitance	$C_i = 1\text{ nF}$	$C_i = 0\ \mu\text{F}$
Input (Sensor)		
Max voltage from transmitter	$U_o = 30\text{ Vdc}$	$V_t = 30\text{ V}$
Max current from transmitter	$I_o = 100\text{ mA}$	$I_t = 25\text{ mA}$
Max power from transmitter	Not specified	Not specified
Max inductance (input loop)	$L_o = 1.4\text{ mH}$	$L_a = 56.8\text{ mH}$
Max capacitance (input loop)	$C_o = 65\text{ nF}$	$C_a = 0.12\ \mu\text{F}$

INPUTS

RTD

Pt100, Pt1000, Ni100, Ni1000, PtX, D100

4-wire connection

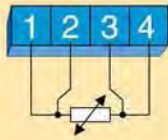

3-wire connection

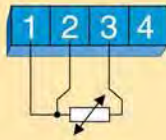

Pt100

3-wire connection

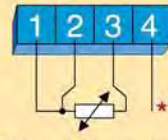

* SmartSense lead

Pt100

Diff temperature $T_1 > T_2$

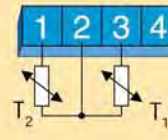

Potentiometer

4-wire connection

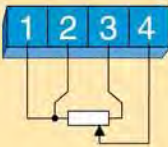

3-wire connection

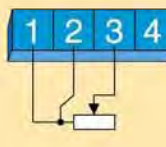

Voltage

millivolt

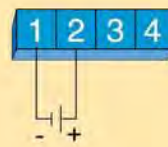

Thermocouple

AE,B,E,J,K,L,N,R,S,T,U or customer specific

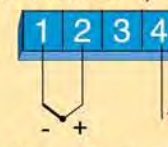

* SmartSense lead

OUTPUT

4-20 mA Output

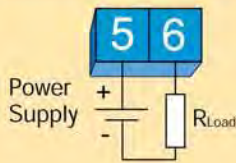

Connections

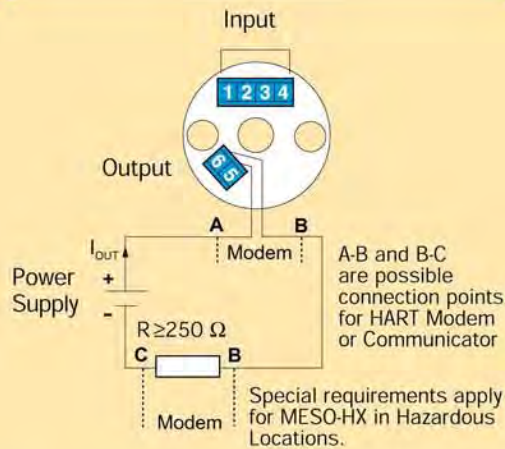

Dimensions

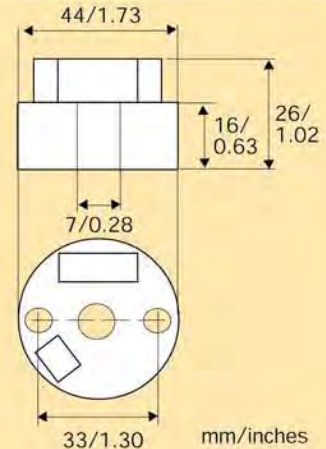

SmartSense

Fig.7

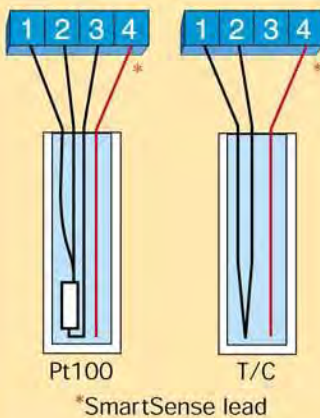

Output load diagram

Fig.8

Permissible R_{Load} at 23 mA output

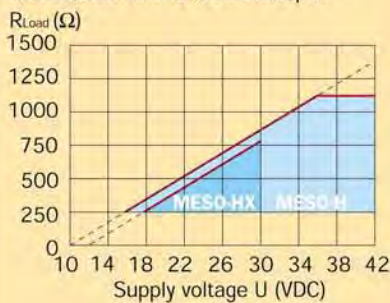

$$R_{Load} = (U-10)/0.023 \quad (\text{MESO-H})$$

$$R_{Load} = (U-12)/0.023 \quad (\text{MESO-HX})$$

Ordering table

Item	Part No.
Transmitter	
MESO-H,	70MEH00001
MESO-HX, (ATEX)	70MEHX0001
MESO-HX, (FM)	70MEHX1001
Options	
Configuration	70CAL00001
Configuration with 5-point calibration certificate	70CAL00051
Software, Modem	
Software MEPRO	70CDSOFT01
HART Modem RS 232	70MEM00001
Accessories	
Surface mounting box	70ADA00008
Rail mounting box	70ADA00009
Head mounting kit	70ADA00012
Rail mounting kit	70ADA00013