

## Pressure Measurement

Pressure transmitters

Single-range transmitters for general applications

1

### SITRANS P200 for gauge and absolute pressure

#### Overview



The SITRANS P200 pressure transmitter measures the gauge and absolute pressure of liquids, gases and vapors.

- Ceramic measuring cell
- Gauge and absolute measuring ranges 1 to 60 bar (15 to 1000 psi)
- For general applications

#### Benefits

- High measuring accuracy
- Rugged stainless steel enclosure
- High overload withstand capability
- For aggressive and non-aggressive media
- For measuring the pressure of liquids, gases and vapors
- Compact design

#### Application

The SITRANS P200 pressure transmitter for gauge and absolute pressure is used in the following industrial areas:

- Mechanical engineering
- Shipbuilding
- Power engineering
- Chemical industry
- Water supply

#### Design

##### Device structure without explosion protection

The pressure transmitter consists of a piezoresistive measuring cell with a diaphragm installed in a stainless steel enclosure. It can be used with a connector per EN 175301-803-A (IP65), a device plug M12 (IP67), a cable (IP67) or a Quickon cable quick screw connection (IP67) connected electrically. The output signal is between 4 and 20 mA or 0 and 10 V.

##### Device structure with explosion protection

The pressure transmitter consists of a piezoresistive measuring cell with a diaphragm installed in a stainless steel enclosure. It can be used with a connector per EN 175301-803-A (IP65) or a device plug M12 (IP67) connected electrically. The output signal is between 4 and 20 mA.

#### Function

The pressure transmitter measures the gauge and absolute pressure of liquids and gases as well as the level of liquids.

##### Mode of operation

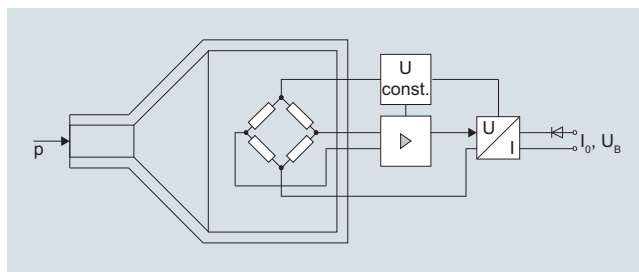

SITRANS P200 pressure transmitters (7MF1565-...), functional diagram

The ceramic measuring cell has a thick-film resistance bridge to which the operating pressure  $p$  is transmitted through a ceramic diaphragm.

The voltage output from the measuring cell is converted by an amplifier into an output current of 4 to 20 mA or an output voltage of 0 to 10 V DC.

The output current and voltage are linearly proportional to the input pressure.

## Pressure Measurement

### Pressure transmitters

#### Single-range transmitters for general applications

#### SITRANS P200 for gauge and absolute pressure

1

#### Technical specifications

<b>Application</b>	Liquids, gases and vapors
Gauge and absolute pressure measurement	
<b>Mode of operation</b>	
Measuring principle	Piezo-resistive measuring cell (ceramic diaphragm)
Measured variable	Gauge and absolute pressure
<b>Inputs</b>	
Measuring range	
• Gauge pressure	
- Metric	1 ... 60 bar (15 ... 870 psi)
- US measuring range	15 ... 1000 psi
• Absolute pressure	
- Metric	0.6 ... 16 bar a
- US measuring range	(10 ... 232 psi abs a) 10 ... 300 psi a
<b>Output</b>	
Current signal	4 ... 20 mA
• Load	( $U_B - 10 \text{ V}$ )/0.02 A
• Auxiliary power $U_B$	DC 7 ... 33 V (10 ... 30 V for Ex)
Voltage signal	0 ... 10 V DC
• Load	$\geq 10 \text{ k}\Omega$
• Auxiliary power $U_B$	12 ... 33 V DC
• Power consumption	< 7 mA at 10 k $\Omega$
Ratiometric output	0 ... 90 %
• Load	$\geq 10 \text{ k}\Omega$
• Auxiliary power $U_B$	5 V DC $\pm 10 \%$
• Power consumption	< 7 mA at 10 k $\Omega$
Characteristic curve	Linear rising
<b>Measuring accuracy</b>	
Error in measurement at limit setting incl. hysteresis and reproducibility	• Typical: 0.25 % of measuring span • Maximum: 0.5 % of measuring span
Step response time $T_{99}$	< 5 ms
Long-term stability	
• Lower range value and measuring span	0.25 % of measuring span/year
Influence of ambient temperature	
• Lower range value and measuring span	0.25 %/10 K of measuring span
• Influence of power supply	0.005 %/V
<b>Operating conditions</b>	
Process temperature with gasket made of:	
• FPM (Standard)	-15 ... +125 °C (+5 ... +257 °F)
• Neoprene	-35 ... +100 °C (-31 ... +212 °F)
• Perbunan	-20 ... +100 °C (-4 ... +212 °F)
• EPDM	-40 ... +125 °C (-40 ... +257 °F), usable for drinking water
Ambient temperature	-25 ... +85 °C (-13 ... +185 °F)
Storage temperature	-50 ... +100 °C (-58 ... +212 °F)
Degree of protection (to EN 60529)	• IP 65 with connector per EN 175301-803-A • IP 67 with device plug M12 • IP 67 with cable • IP 67 with cable quick screw connection

Electromagnetic compatibility	• acc. IEC 61326-1/-2/-3 • acc. NAMUR NE21, only for ATEX versions and with a max. measuring deviation $\leq 1 \%$
<b>Design</b>	
Weight	Approx. 0.090 kg (0.198 lb)
Process connections	See dimension drawings
Electrical connections	• Connector per EN 175301-803-A Form A with cable inlet M16x1.5 or 1/2-14 NPT or Pg 11 • Device plug M12 • 2 or 3-wire (0.5 mm <sup>2</sup> ) cable ( $\varnothing \pm 5.4 \text{ mm}$ ) • Quickon cable quick screw connection
Wetted parts materials	
• Measuring cell	Al <sub>2</sub> O <sub>3</sub> - 96 %
• Process connection	Stainless steel, mat. No. 1.4404 (SST 316 L)
• Gasket	• FPM (Standard) • Neoprene • Perbunan • EPDM
Non-wetted parts materials	
• Enclosure	Stainless steel, mat. No. 1.4404 (SST 316 L)
• Rack	Plastic
• Cables	PVC
<b>Certificates and approvals</b>	
Classification according to pressure equipment directive (PED 2014/68/EU)	For gases of fluid group 1 and liquids of fluid group 1; complies with requirements of article 4, paragraph 3 (sound engineering practice)
Lloyd's Register of Shipping (LR) <sup>1)</sup>	12/20010
Germanischer Lloyd (GL) <sup>1)</sup>	GL19740 11 HH00
American Bureau of Shipping (ABS) <sup>1)</sup>	ABS_11_HG 789392_PDA
Bureau Veritas (BV) <sup>1)</sup>	BV 271007A0 BV
Det Norske Veritas (DNV) <sup>1)</sup>	A 12553
Drinking water approval (ACS) <sup>1)</sup>	ACS 15 ACC NY 360
EAC <sup>1)</sup>	№ TC RU C-DE.ГБ05.В.00732 OC НАИИО «ЦБВЭ»
Underwriters Laboratories (UL) <sup>1)</sup>	
• for USA and Canada	UL 20110217 - E34453
• worldwide	IEC UL DK 21845
<b>Explosion protection</b>	
Intrinsic safety "i" (only with current output)	Ex II 1/2 G Ex ia IIC T4 Ga/Gb Ex II 1/2 D Ex ia IIIC T125 °C Da/Db
EC type-examination certificate	SEV 10 ATEX 0146
Connection to certified intrinsically-safe resistive circuits with maximum values:	$U_i \leq 30 \text{ V DC}$ ; $I_i \leq 100 \text{ mA}$ ; $P_i \leq 0.75 \text{ W}$
Effective internal inductance and capacity for versions with plugs per EN 175301-803-A and M12	$L_i = 0 \text{ nH}$ ; $C_i = 0 \text{ nF}$

<sup>1)</sup> For variants with output signal 0 ... 5 V and ratiometric output available soon.

# Pressure Measurement

## Pressure transmitters

### Single-range transmitters for general applications

1

#### SITRANS P200 for gauge and absolute pressure

##### Selection and ordering data

**SITRANS P 200 pressure transmitters for pressure and absolute pressure for general applications** ↗

Characteristic curve deviation typ. 0.25 %

Wetted parts materials: Ceramic and stainless steel + sealing material

Non-wetted parts materials: stainless steel

↗ Click on the Article No. for the online configuration in the PIA Life Cycle Portal.

Article No.

Order code

7MF1565 -

Measuring range	Overload limit		Burst pressure
	Min.	Max.	

##### For gauge pressure

0 ... 1 bar (0 ... 14.5 psi)	-1 bar (-14.5 psi)	2.5 bar (36.26 psi)	> 2.5 bar (> 36.3 psi)
0 ... 1.6 bar (0 ... 23.2 psi)	-1 bar (-14.5 psi)	4 bar (58.02 psi)	> 4 bar (> 58.0 psi)
0 ... 2.5 bar (0 ... 36.3 psi)	-1 bar (-14.5 psi)	6.25 bar (90.65 psi)	> 6.25 bar (> 90.7 psi)
0 ... 4 bar (0 ... 58.0 psi)	-1 bar (-14.5 psi)	10 bar (145 psi)	> 10 bar (> 145 psi)
0 ... 6 bar (0 ... 87.0 psi)	-1 bar (-14.5 psi)	15 bar (217 psi)	> 15 bar (> 217 psi)
0 ... 10 bar (0 ... 145 psi)	-1 bar (-14.5 psi)	25 bar (362 psi)	> 25 bar (> 362 psi)
0 ... 16 bar (0 ... 232 psi)	-1 bar (-14.5 psi)	40 bar (580 psi)	> 40 bar (> 580 psi)
0 ... 25 bar (0 ... 363 psi)	-1 bar (-14.5 psi)	62.5 bar (906 psi)	> 62.5 bar (> 906 psi)
0 ... 40 bar (0 ... 580 psi)	-1 bar (-14.5 psi)	100 bar (1450 psi)	> 100 bar (> 1450 psi)
0 ... 60 bar (0 ... 870 psi)	-1 bar (-14.5 psi)	150 bar (2175 psi)	> 150 bar (> 2175 psi)

Other version, add Order code and plain text: Measuring range: ... up to ... bar (psi)

##### For absolute pressure

0 ... 0.6 bar a (0 ... 8.7 psi a)	0 bar a (0 psi a)	2.5 bar a (36.26 psi a)	> 2.5 bar a (> 36.3 psi a)
0 ... 1 bar a (0 ... 14.5 psi a)	0 bar a (0 psi a)	2.5 bar a (36.26 psi a)	> 2.5 bar a (> 36.3 psi a)
0 ... 1.6 bar a (0 ... 23.2 psi a)	0 bar a (0 psi a)	4 bar a (58.02 psi a)	> 4 bar a (> 58.0 psi a)
0 ... 2.5 bar a (0 ... 36.3 psi a)	0 bar a (0 psi a)	6.25 bar a (90.65 psi a)	> 6.25 bar a (> 90.7 psi a)
0 ... 4 bar a (0 ... 58.0 psi a)	0 bar a (0 psi a)	10 bar a (145 psi a)	> 10 bar a (> 145 psi a)
0 ... 6 bar a (0 ... 87.0 psi a)	0 bar a (0 psi a)	15 bar a (217 psi a)	> 15 bar a (> 217 psi a)
0 ... 10 bar a (0 ... 145 psi)	0 bar a (0 psi a)	25 bar a (362 psi a)	> 25 bar a (> 362 psi a)
0 ... 16 bar a (0 ... 232 psi)	0 bar a (0 psi a)	40 bar a (580 psi a)	> 40 bar a (> 580 psi a)

Other version, add Order code and plain text: Measuring range: ... up to ... mbar a (psi a)

##### Measuring ranges for gauge pressure

0 ... 15 psi	-14.5 psi	35 psi	> 35 psi
3 ... 15 psi	-14.5 psi	35 psi	> 35 psi
0 ... 20 psi	-14.5 psi	50 psi	> 50 psi
0 ... 30 psi	-14.5 psi	80 psi	> 80 psi
0 ... 60 psi	-14.5 psi	140 psi	> 140 psi
0 ... 100 psi	-14.5 psi	200 psi	> 200 psi
0 ... 150 psi	-14.5 psi	350 psi	> 350 psi
0 ... 200 psi	-14.5 psi	550 psi	> 550 psi
0 ... 300 psi	-14.5 psi	800 psi	> 800 psi
0 ... 500 psi	-14.5 psi	1400 psi	> 1400 psi
0 ... 750 psi	-14.5 psi	2000 psi	> 2000 psi
0 ... 1000 psi	-14.5 psi	2000 psi	> 2000 psi

Other version, add Order code and plain text: Measuring range: ... up to ... psi

##### Measuring ranges for absolute pressure

0 ... 10 psi a	0 psi a	35 psi a	> 35 psi a
0 ... 15 psi a	0 psi a	35 psi a	> 35 psi a
0 ... 20 psi a	0 psi a	50 psi a	> 50 psi a
0 ... 30 psi a	0 psi a	80 psi a	> 80 psi a
0 ... 60 psi a	0 psi a	140 psi a	> 140 psi a
0 ... 100 psi a	0 psi a	200 psi a	> 200 psi a
0 ... 150 psi a	0 psi a	350 psi a	> 350 psi a
0 ... 200 psi a	0 psi a	550 psi a	> 550 psi a
0 ... 300 psi a	0 psi a	800 psi a	> 800 psi a

Other version, add Order code and plain text: Measuring range: ... up to ... psi a

3 BA  
3 BB  
3 BD  
3 BE  
3 BG  
3 CA  
3 CB  
3 CD  
3 CE  
3 CG

9 AA

H1 Y

5 AG  
5 BA  
5 BB  
5 BD  
5 BE  
5 BG  
5 CA  
5 CB

9 AA

H2 Y

4 BB  
4 BC  
4 BD  
4 BE  
4 BF  
4 BG  
4 CA  
4 CB  
4 CD  
4 CE  
4 CF  
4 CG

9 AA

H1 Y

6 AG  
6 BA  
6 BB  
6 BD  
6 BE  
6 BG  
6 CA  
6 CB  
6 CC

9 AA

H2 Y

**Pressure Measurement**

Pressure transmitters

Single-range transmitters for general applications

**SITRANS P200 for gauge and absolute pressure**

1

Selection and ordering data	Article No.	Order code
<p><b>SITRANS P 200 pressure transmitters for pressure and absolute pressure for general applications</b></p> <p>Accuracy typ. 0.25 %</p> <p>Wetted parts materials: Ceramic and stainless steel + sealing material</p> <p>Non-wetted parts materials: stainless steel</p>	7MF1565-	
<p><b>Output signal</b></p> <p>4 ... 20 mA; two-wire system; power supply 7 ... 33 V DC (10 ... 30 V DC for ATEX versions)</p> <p>0 ... 10 V; three-wire system; power supply 12 ... 33 V DC</p> <p>0 ... 5 V; 3-wire system; auxiliary power 7 ... 33 V DC</p> <p>Ratiometric 10 ... 90 %; 3-wire system; auxiliary power 5 V DC ± 10 %</p>		0 10 20 30
<p><b>Explosion protection (only 4 ... 20 mA)</b></p> <p>None</p> <p>With explosion protection Ex ia IIC T4</p>		0 1
<p><b>Electrical connection</b></p> <p>Connector per DIN EN 175301-803-A, stuffing box thread M16 (with coupling)</p> <p>Device plug M12 per IEC 61076-2-101</p> <p>Connection via fixed mounted cable, 2 m (not for type of protection "Intrinsic safety i")</p> <p>Quickon cable quick screw connection PG9 (not for type of protection "Intrinsic safety i")</p> <p>Connector per DIN EN 175301-803-A, stuffing box thread 1/2"-14 NPT (with coupling)</p> <p>Connector per DIN EN 175301-803-A, stuffing box thread PG11 (with coupling)</p> <p>Fixed mounted cable, length 5 m</p> <p>Special version</p>		1 2 03 04 5 6 07 9 N1Y
<p><b>Process connection</b></p> <p>G1/2" male per EN 837-1 (1/2" BSP male) (standard for metric pressure ranges mbar, bar)</p> <p>G1/2" male thread and G1/8" female thread</p> <p>G1/4" male per EN 837-1 (1/4" BSP male)</p> <p>7/16"-20 UNF male</p> <p>1/4"-18 NPT male (standard for pressure ranges inH<sub>2</sub>O and psi)</p> <p>1/4"-18 NPT female</p> <p>1/2"-14 NPT male</p> <p>1/2"-14 NPT female</p> <p>7/16"-20 UNF female</p> <p>M20x1.5 male</p> <p>G1/4" to DIN 3852 Form E</p> <p>G1/2" to DIN 3852 Form E</p> <p>Special version</p>		A B C D E F G H J P Q R Z P1Y
<p><b>Sealing material between sensor and enclosure</b></p> <p>Viton (FPM, standard)</p> <p>Neoprene (CR)</p> <p>Perbunan (NBR)</p> <p>EPDM</p> <p>Special version</p>		A B C D Z Q1Y
<p><b>Version</b></p> <p>Standard version</p>		1
<p><b>Further designs</b></p> <p>Supplement the Article No. with "-Z" and add Order code.</p> <p>Quality test certificate, 5-point factory calibration (IEC 60770-2)</p> <p>Oxygen version, free of oil and degreased, max. operating pressure 60 bar, max. temperature of medium +85 °C (only in conjunction with the sealing material Viton between sensor and enclosure and not with explosion protection version)</p>	C11 E10	

## Pressure Measurement

Pressure transmitters

Single-range transmitters for general applications

1

### SITRANS P200 for gauge and absolute pressure

#### Dimensional drawings

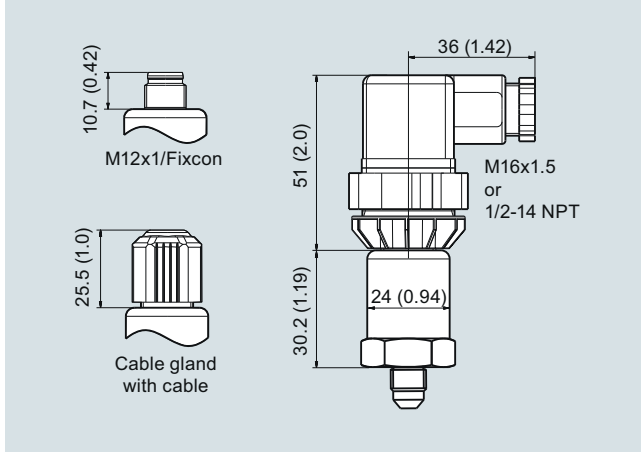

SITRANS P200, electrical connections, dimensions in mm (inch)

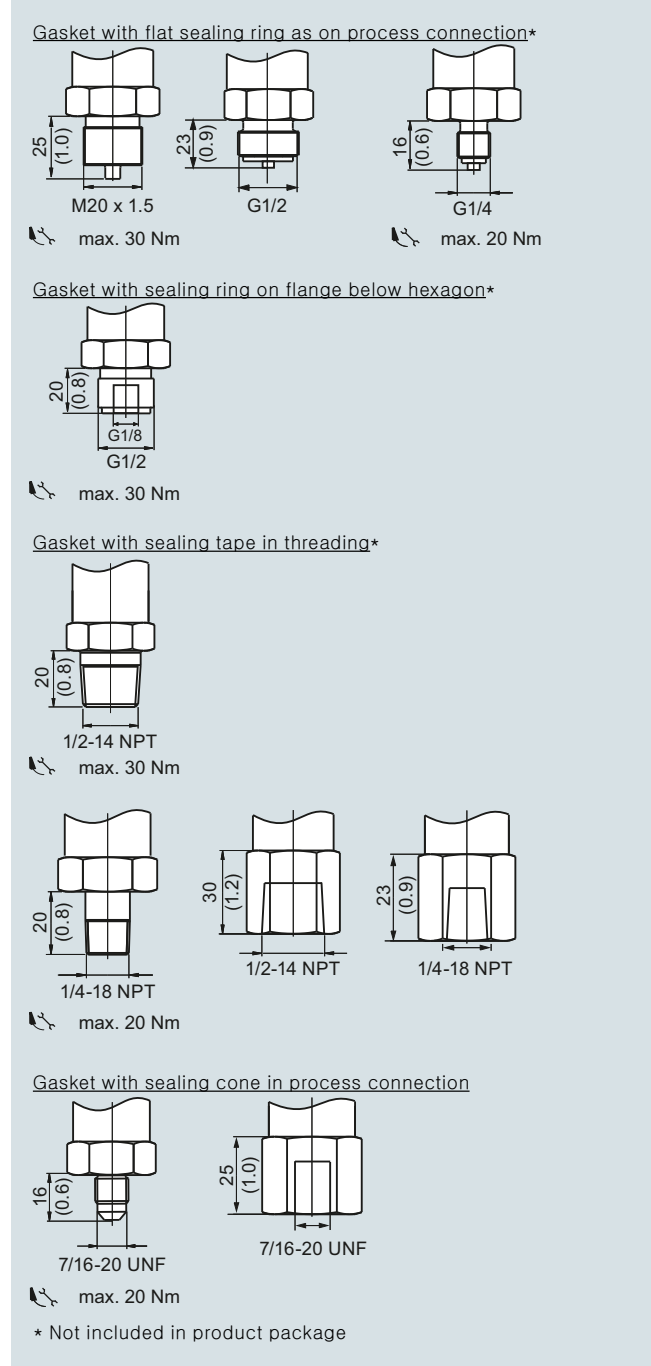

SITRANS P200, process connections, dimensions in mm (inch)

## Pressure Measurement

### Pressure transmitters

#### Single-range transmitters for general applications

#### SITRANS P200 for gauge and absolute pressure

### Schematics

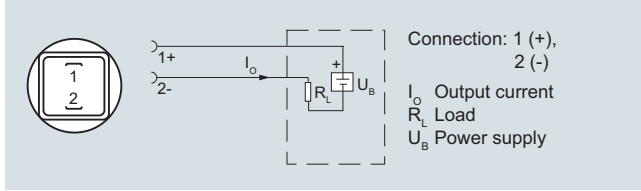

Connection with current output and connector per EN 175301

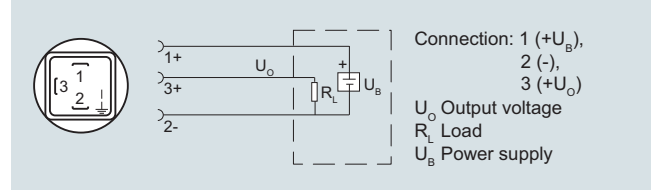

Connection with voltage output, ratiometric output and plug according to EN 175301

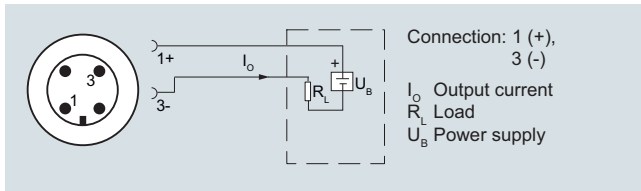

Connection with current output and device plug M12x1

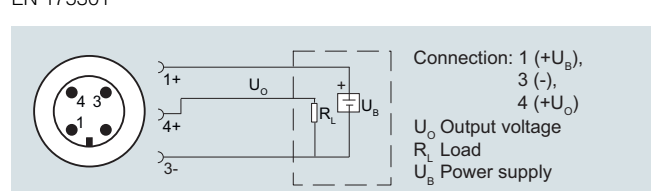

Connection with voltage output, ratiometric output and device plug M12x1

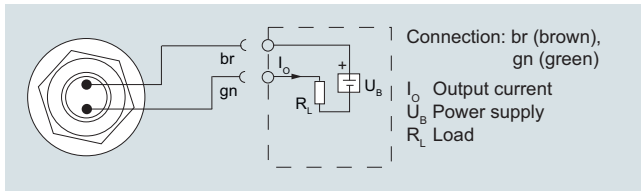

Connection with current output and cable

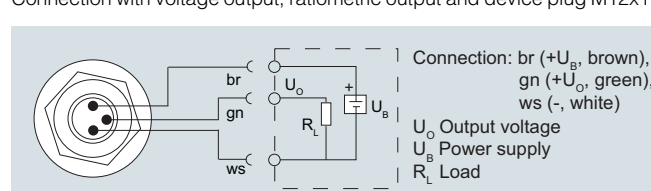

Connection with voltage output, ratiometric output and cable

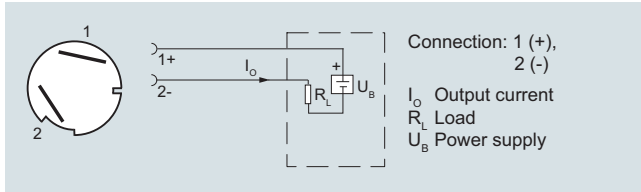

Connection with current output and Quickon cable quick screw connection

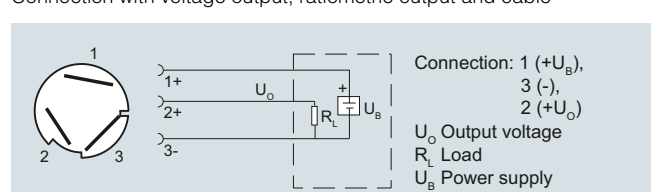

Connection with voltage output, ratiometric output and Quickon fast cable termination

### Version with explosion protection: 4 ... 20 mA

The grounding connection is conductively bonded to the transmitter enclosure

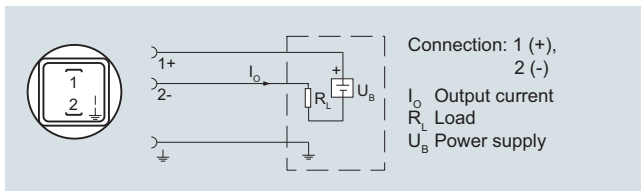

Connection with current output and connector per EN 175301 (Ex)

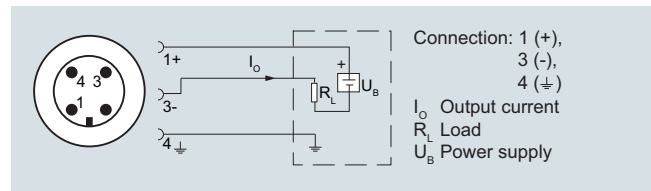

Connection with current output and device plug M12x1 (Ex)

## Pressure Measurement

Pressure transmitters

Single-range transmitters for general applications

1

### SITRANS P210 for gauge pressure

#### Overview



The pressure transmitter SITRANS P210 measures the gauge pressure of liquids, gases and vapors.

- Stainless steel measuring cell
- Measuring ranges 100 to 600 mbar (1.45 to 8.7 psi) relative
- For low-pressure applications

#### Benefits

- High measuring accuracy
- Rugged stainless steel enclosure
- High overload withstand capability
- For aggressive and non-aggressive media
- For measuring the pressure of liquids, gases and vapors
- Compact design

#### Application

The pressure transmitter SITRANS P210 for gauge pressure is used in the following industrial areas:

- Mechanical engineering
- Shipbuilding
- Power engineering
- Chemical industry
- Water supply

#### Design

##### **Device structure without explosion protection**

The pressure transmitter consists of a piezoresistive measuring cell with a diaphragm installed in a stainless steel enclosure. It can be used with a connector per EN 175301-803-A (IP65), a device plug M12 (IP67), a cable (IP67) or a Quickon cable quick screw connection (IP67) connected electrically. The output signal is between 4 and 20 mA or 0 and 10 V.

##### **Device structure with explosion protection**

The pressure transmitter consists of a piezoresistive measuring cell with a diaphragm installed in a stainless steel enclosure. It can be used with a connector per EN 175301-803-A (IP65) or a device plug M12 (IP67) connected electrically. The output signal is between 4 and 20 mA.

#### Function

The pressure transmitter measures the gauge pressure of liquids and gases as well as the level of liquids.

##### **Mode of operation**

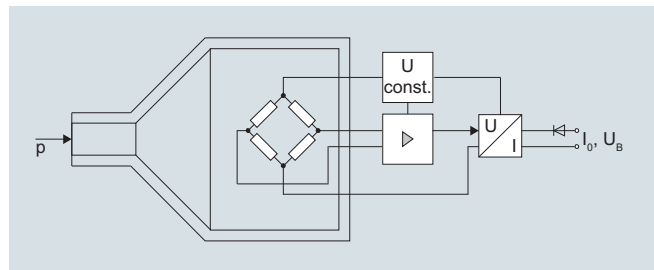

SITRANS P210 pressure transmitters (7MF1566-...), functional diagram

The stainless steel measuring cell has a thin-film resistance bridge to which the operating pressure  $p$  is transmitted through a stainless steel diaphragm.

The voltage output from the measuring cell is converted by an amplifier into an output current of 4 to 20 mA or an output voltage of 0 to 10 V DC.

The output current and voltage are linearly proportional to the input pressure.

## Technical specifications

<b>Application</b>	Gauge measurement	Liquids, gases and vapors
<b>Mode of operation</b>	Measuring principle	Piezoresistive measuring cell (stainless steel diaphragm)
Measured variable		Gauge pressure
<b>Inputs</b>	Measuring range	100 ... 600 mbar (1.5 ... 8.7 psi)
• Gauge pressure		
<b>Output</b>	Current signal	4 ... 20 mA
• Load		$(U_B - 10 \text{ V})/0.02 \text{ A}$
• Auxiliary power $U_B$		DC 7 ... 33 V (10 ... 30 V for Ex)
Voltage signal		0 ... 10 V DC
• Load		$\geq 10 \text{ k}\Omega$
• Auxiliary power $U_B$		12 ... 33 V DC
• Power consumption		< 7 mA at 10 k $\Omega$
Ratiometric output		0 ... 90 %
• Load		$\geq 10 \text{ k}\Omega$
• Auxiliary power $U_B$		5 V DC $\pm 10 \%$
• Power consumption		< 7 mA at 10 k $\Omega$
Characteristic curve		Linear rising
<b>Measuring accuracy</b>	Error in measurement at limit setting incl. hysteresis and reproducibility	<ul style="list-style-type: none"> <li>• Typical: 0.25 % of measuring span</li> <li>• Maximum: 0.5 % of measuring span</li> </ul>
Step response time $T_{99}$		< 5 ms
Long-term stability		0.25 % of measuring span/year span
• Lower range value and measuring span		
Influence of ambient temperature		0.25 %/10 K of measuring span
• Lower range value and measuring span		0.5 %/10K of measuring span for a measuring range 100 ... 400 mbar
• Influence of power supply		0.005 %/V
<b>Operating conditions</b>	Process temperature with gasket made of:	
• FPM (Standard)		-15 ... +125 °C (+5 ... +257 °F)
• Neoprene		-35 ... +100 °C (-31 ... +212 °F)
• Perbunan		-20 ... +100 °C (-4 ... +212 °F)
• EPDM		-40 ... +125 °C (-40 ... +257 °F), usable for drinking water
Ambient temperature		-25 ... +85 °C (-13 ... +185 °F)
Storage temperature		-50 ... +100 °C (-58 ... +212 °F)
Degree of protection (to EN 60529)		<ul style="list-style-type: none"> <li>• IP 65 with connector per EN 175301-803-A</li> <li>• IP 67 with device plug M12</li> <li>• IP 67 with cable</li> <li>• IP 67 with cable quick screw connection</li> </ul>
Electromagnetic compatibility		<ul style="list-style-type: none"> <li>• acc. IEC 61326-1/-2/-3</li> <li>• acc. NAMUR NE21, only for ATEX versions and with a max. measuring deviation <math>\leq 1 \%</math></li> </ul>
Mounting position		upright

<b>Design</b>	Weight	Approx. 0.090 kg (0.198 lb)
Process connections		See dimension drawings
Electrical connections		<ul style="list-style-type: none"> <li>• Connector per EN 175301-803-A Form A with cable inlet M16x1.5 or 1/2-14 NPT or Pg 11</li> <li>• Device plug M12</li> <li>• 2 or 3-wire (0.5 mm<sup>2</sup>) cable (<math>\varnothing \pm 5.4 \text{ mm}</math>)</li> <li>• Quickon cable quick screw connection</li> </ul>
Wetted parts materials		
• Measuring cell		Stainless steel, mat.-No. 1.4435
• Process connection		Stainless steel, mat. No. 1.4404 (SST 316 L)
• Gasket		<ul style="list-style-type: none"> <li>• FPM (Standard)</li> <li>• Neoprene</li> <li>• Perbunan</li> <li>• EPDM</li> </ul>
Non-wetted parts materials		
• Enclosure		Stainless steel, mat. No. 1.4404 (SST 316 L)
• Rack		Plastic
• cables		PVC
<b>Certificates and approvals</b>	Classification according to pressure equipment directive (PED 2014/68/EU)	For gases of fluid group 1 and liquids of fluid group 1; meets requirements as per article 4, paragraph 3 (good engineering practice)
Lloyd's Register of Shipping (LR) <sup>1)</sup>		12/20010
Germanischer Lloyd (GL) <sup>1)</sup>		GL19740 11 HH00
American Bureau of Shipping (ABS) <sup>1)</sup>		ABS_11_HG 789392_PDA
Bureau Veritas (BV) <sup>1)</sup>		BV 271007A0 BV
Det Norske Veritas (DNV) <sup>1)</sup>		A 12553
Drinking water approval (ACS) <sup>1)</sup>		ACS 15 ACC NY 360
EAC <sup>1)</sup>		№ TC RU C-DE.ГБ05.В.00732 ОС НАИНО «ЦСВЭ»
Underwriters Laboratories (UL) <sup>1)</sup>		
• for USA and Canada		UL 20110217 - E34453
• worldwide		IEC UL DK 21845
<b>Explosion protection</b>	Intrinsic safety "i" (only with current output)	Ex II 1/2 G Ex ia IIC T4 Ga/Gb Ex II 1/2 D Ex ia IIIC T125 °C Da/Db
EC type-examination certificate		SEV 10 ATEX 0146
Connection to certified intrinsically-safe resistive circuits with maximum values:		$U_i \leq 30 \text{ V DC}$ ; $I_i \leq 100 \text{ mA}$ ; $P_i \leq 0.75 \text{ W}$
Effective internal inductance and capacity for versions with plugs per EN 175301-803-A and M12		$L_i = 0 \text{ nH}$ ; $C_i = 0 \text{ nF}$

<sup>1)</sup> For variants with output signal 0 ... 5 V and ratiometric output available soon.



## Pressure Measurement

Pressure transmitters

Single-range transmitters for general applications

1

### SITRANS P210 for gauge pressure

#### Selection and ordering data

**SITRANS P 210 pressure transmitters for gauge pressure for low pressure applications**

Accuracy typ. 0.25 %

Wetted parts materials: Stainless steel + sealing material

Non-wetted parts materials: stainless steel

Click on the Article No. for the online configuration in the PIA Life Cycle Portal.

Article No.

Order code

7MF1566 - - - - -

Measuring range	Overload limit		Burst pressure
	min.	max.	
<b>For gauge pressure</b>			
0...100 mbar (1.45 psi)	-400 mbar (-5.8 psi)	400 mbar (5.8 psi)	1 bar (14.5 psi)
0...160 mbar (2.32 psi)	-400 mbar (-5.8 psi)	400 mbar (5.8 psi)	1 bar (14.5 psi)
0...250 mbar (3.63 psi)	-800 mbar (-11.6 psi)	1000 mbar (14.5 psi)	2 bar (29.0 psi)
0...400 mbar (5.8 psi)	-800 mbar (-11.6 psi)	1000 mbar (14.5 psi)	2 bar (29.0 psi)
0...600 mbar (8.7 psi)	-1000 mbar (-14.5 psi)	2000 mbar (29.0 psi)	3 bar (43.5 psi)

Other version, add Order code and plain text:

Measuring range: ... up to ... mbar (psi)

#### Output signal

4 ... 20 mA; two-wire system; power supply 7 ... 33 V DC (10 ... 30 V DC for ATEX versions)

0 ... 10 V; three-wire system; power supply 12 ... 33 V DC

0 ... 5 V; 3-wire system; auxiliary power 7 ... 33 V DC

Ratiometric 10 ... 90 %; 3-wire system; auxiliary power 5 V DC ± 10 %

#### Explosion protection (only 4 ... 20 mA)

None

With explosion protection Ex ia IIC T4

#### Electrical connection

Connector per DIN EN 175301-803-A, stuffing box thread M16 (with coupling)

Device plug M12 per IEC 61076-2-101

Connection via fixed mounted cable, 2 m (not for type of protection "Intrinsic safety i")

Quickon cable quick screw connection PG9 (not for type of protection "Intrinsic safety i")

Connector per DIN EN 175301-803-A, stuffing box thread 1/2"-14 NPT (with coupling)

Connector per DIN EN 175301-803-A, stuffing box thread PG11 (with coupling)

Fixed mounted cable, length 5 m

Special version

#### Process connection

G1/2" male per EN 837-1 (1/2" BSP male) (standard for metric pressure ranges mbar, bar)

G1/2" male thread and G1/8" female thread

G1/4" male per EN 837-1 (1/4" BSP male)

7/16"-20 UNF male

1/4"-18 NPT male (standard for pressure ranges inH<sub>2</sub>O and psi)

1/4"-18 NPT female

1/2"-14 NPT male

1/2"-14 NPT female

7/16"-20 UNF female

M20x1.5 male

G1/4" to DIN 3852 Form E

G1/2" to DIN 3852 Form E

Special version

#### Sealing material between sensor and enclosure

Viton (FPM, standard)

Neoprene (CR)

Perbunan (NBR)

EPDM

Special version

#### Version

Standard version

#### Further designs

Supplement the Article No. with "-Z" and add Order code.

Quality test certificate, 5-point factory calibration (IEC 60770-2)

3 AA

3 AB

3 AC

3 AD

3 AG

9 AA

H 1 Y

0

10

20

30

0

1

1

2

03

04

5

6

07

9

N 1 Y

A

B

C

D

E

F

G

H

J

P

Q

R

Z

P 1 Y

A

B

C

D

Z

Q 1 Y

1

C11

**Dimensional drawings**

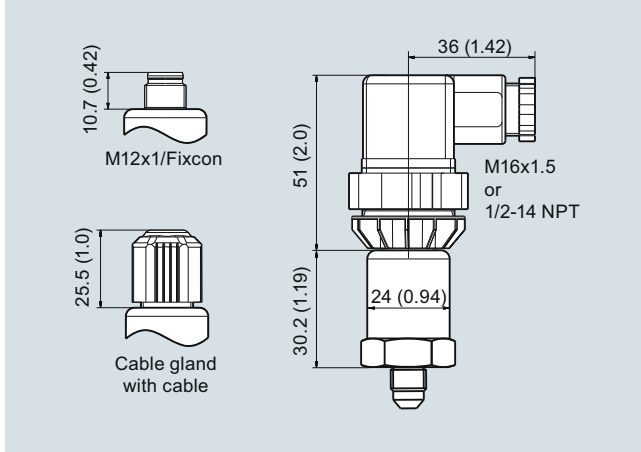

SITRANS P210, electrical connections, dimensions in mm (inch)

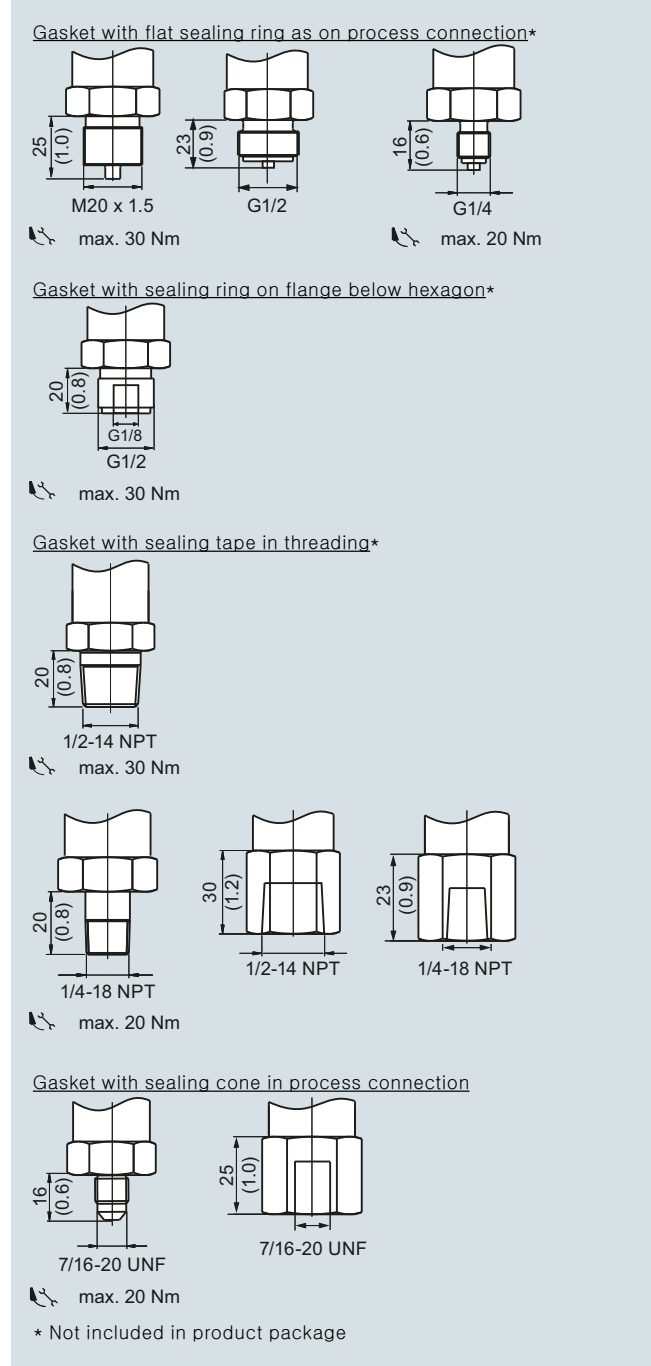

SITRANS P210, process connections, dimensions in mm (inch)

## Pressure Measurement

Pressure transmitters

Single-range transmitters for general applications

1

### SITRANS P210 for gauge pressure

#### Schematics

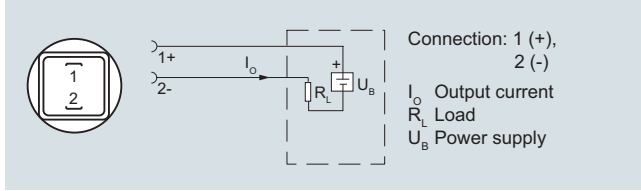

Connection with current output and connector per EN 175301

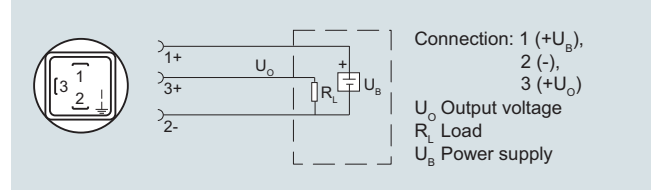

Connection with voltage output, ratiometric output and plug according to EN 175301

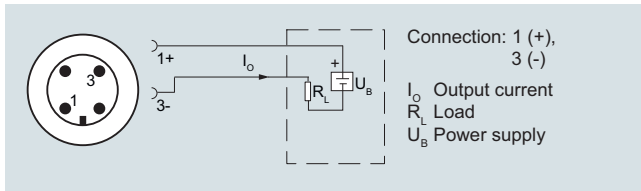

Connection with current output and device plug M12x1

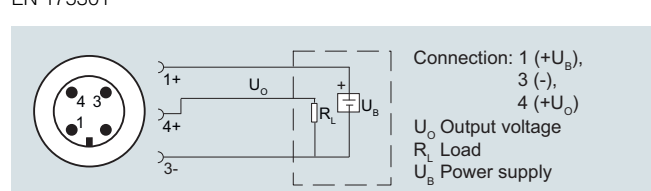

Connection with voltage output, ratiometric output and device plug M12x1

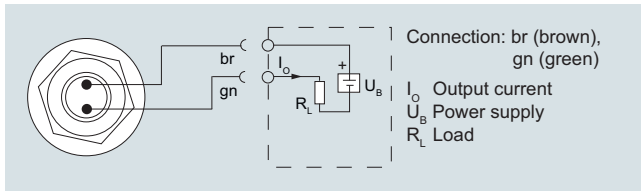

Connection with current output and cable

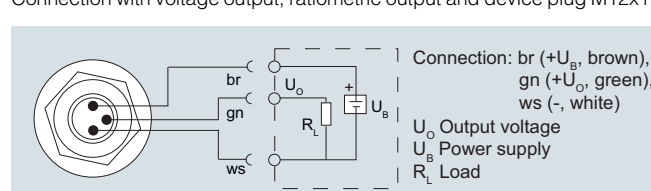

Connection with voltage output, ratiometric output and cable

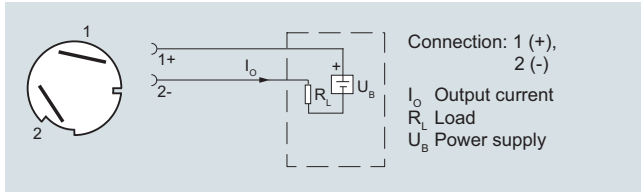

Connection with current output and Quickon cable quick screw connection

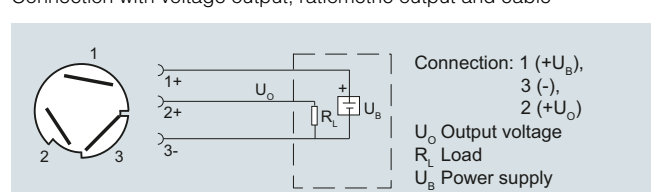

Connection with voltage output, ratiometric output and Quickon fast cable termination

#### Version with explosion protection: 4 ... 20 mA

The grounding connection is conductively bonded to the transmitter enclosure

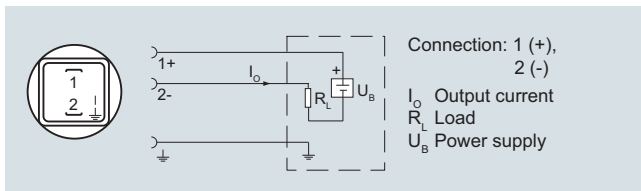

Connection with current output and connector per EN 175301 (Ex)

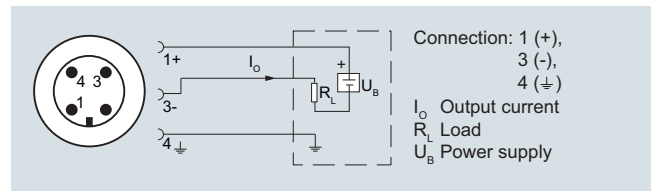

Connection with current output and device plug M12x1 (Ex)

## Pressure Measurement

### Pressure transmitters

#### Single-range transmitters for general applications

##### SITRANS P220 for gauge pressure

1

### Overview



The pressure transmitter SITRANS P220 measures the gauge pressure of liquids, gases and vapors.

- Stainless steel measuring cell, fully welded
- Measuring ranges 2.5 to 1000 bar (36.3 to 14500 psi) relative
- For high-pressure applications and refrigeration technology division

### Benefits

- High measuring accuracy
- Rugged stainless steel enclosure
- High overload withstand capability
- For aggressive and non-aggressive media
- For measuring the pressure of liquids, gases and vapors
- Compact design
- Gasket-less

### Application

The pressure transmitter SITRANS P220 for gauge pressure is used in the following industrial areas:

- Mechanical engineering
- Shipbuilding
- Power engineering
- Chemical industry
- Water supply

### Design

#### **Device structure without explosion protection**

The pressure transmitter consists of a piezoresistive measuring cell with a diaphragm installed in a stainless steel enclosure. It can be used with a connector per EN 175301-803-A (IP65), a device plug M12 (IP67), a cable (IP67) or a Quickon cable quick screw connection (IP67) connected electrically. The output signal is between 4 and 20 mA or 0 and 10 V.

#### **Device structure with explosion protection**

The pressure transmitter consists of a piezoresistive measuring cell with a diaphragm installed in a stainless steel enclosure. It can be used with a connector per EN 175301-803-A (IP65) or a device plug M12 (IP67) connected electrically. The output signal is between 4 and 20 mA.

### Function

The pressure transmitter measures the gauge pressure of liquids and gases as well as the level of liquids.

#### **Mode of operation**

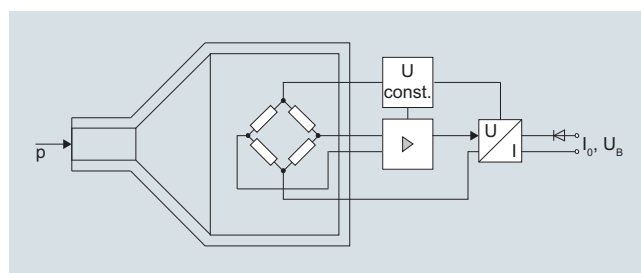

SITRANS P220 pressure transmitters (7MF1567-...), functional diagram

The stainless steel measuring cell has a thick-film resistance bridge to which the operating pressure  $p$  is transmitted through a stainless steel diaphragm.

The voltage output from the measuring cell is converted by an amplifier into an output current of 4 to 20 mA or an output voltage of 0 to 10 V DC.

The output current and voltage are linearly proportional to the input pressure.

## Pressure Measurement

Pressure transmitters

Single-range transmitters for general applications

1

### SITRANS P220 for gauge pressure

#### Technical specifications

<b>Application</b>	Gauge pressure measurement	Liquids, gases and vapors	<b>Design</b>	Weight	Approx. 0.090 kg (0.198 lb)
<b>Mode of operation</b>	Measuring principle	Piezoresistive measuring cell (stainless steel diaphragm)	Process connections	Electrical connections	See dimension drawings
Measured variable	Gauge pressure		Wetted parts materials	<ul style="list-style-type: none"> <li>• Connector per EN 175301-803-A Form A with cable inlet M16x1.5 or ½-14 NPT or Pg 11</li> <li>• Device plug M12</li> <li>• 2 or 3-wire (0.5 mm<sup>2</sup>) cable (∅ ± 5.4 mm)</li> <li>• Quickon cable quick screw connection</li> </ul>	
<b>Inputs</b>	Measuring range		Non-wetted parts materials	<ul style="list-style-type: none"> <li>• Measuring cell</li> <li>• Process connection</li> </ul>	Stainless steel, mat.-No. 1.4016 Stainless steel, mat. No. 1.4404 (SST 316 L)
<ul style="list-style-type: none"> <li>• Gauge pressure</li> <li>- Metric</li> <li>- US measuring range</li> </ul>	2.5 ... 1000 bar (36 ... 14500 psi) 30... 14500 psi		<ul style="list-style-type: none"> <li>• Enclosure</li> </ul>	Stainless steel, mat. No. 1.4404 (SST 316 L) Plastic PVC	
<b>Output</b>	Current signal	4 ... 20 mA	<b>Certificates and approvals</b>	Classification according to pressure equipment directive (PED 2014/68/EU)	For gases of fluid group 1 and liquids of fluid group 1; complies with requirements of article 4, paragraph 3 (sound engineering practice)
<ul style="list-style-type: none"> <li>• Load</li> <li>• Auxiliary power U<sub>B</sub></li> </ul>	(U <sub>B</sub> - 10 V)/0.02 A DC 7 ... 33 V (10 ... 30 V for Ex)		Lloyd's Register of Shipping (LR) <sup>1)</sup>	12/20010	
Voltage signal	0 ... 10 V DC		Germanischer Lloyd (GL) <sup>1)</sup>	GL19740 11 HH00	
<ul style="list-style-type: none"> <li>• Load</li> <li>• Auxiliary power U<sub>B</sub></li> <li>• Power consumption</li> </ul>	≥ 10 kΩ 12 ... 33 V DC < 7 mA at 10 kΩ		American Bureau of Shipping (ABS) <sup>1)</sup>	ABS_11_HG 789392_PDA	
Ratiometric output	0 ... 90 %		Bureau Veritas (BV) <sup>1)</sup>	BV 271007A0 BV	
<ul style="list-style-type: none"> <li>• Load</li> <li>• Auxiliary power U<sub>B</sub></li> <li>• Power consumption</li> </ul>	≥ 10 kΩ 5 V DC ± 10 % < 7 mA at 10 kΩ		Det Norske Veritas (DNV) <sup>1)</sup>	A 12553	
Characteristic curve	Linear rising		Drinking water approval (ACS) <sup>1)</sup>	ACS 15 ACC NY 360	
<b>Measuring accuracy</b>	Error in measurement at limit setting incl. hysteresis and reproducibility	<ul style="list-style-type: none"> <li>• Typical: 0.25 % of measuring span</li> <li>• Maximum: 0.5 % of measuring span</li> </ul>	EAC <sup>1)</sup>	№ TC RU C-DE.ГБ05.В.00732 OC НАИИО «ЦСВЭ»	
Step response time T <sub>99</sub>	< 5 ms		CRN <sup>2)</sup>	0F18659.5C	
Long-term stability			Underwriters Laboratories (UL) <sup>1)</sup>	UL 20110217 - E34453	
<ul style="list-style-type: none"> <li>• Lower range value and measuring span</li> </ul>	0.25 % of measuring span/year		<ul style="list-style-type: none"> <li>• for USA and Canada</li> <li>• worldwide</li> </ul>	IEC UL DK 21845	
Influence of ambient temperature			<b>Explosion protection</b>	Intrinsic safety "i" (only with current output)	Ex II 1/2 G Ex ia IIC T4 Ga/Gb Ex II 1/2 D Ex ia IIIC T125 °C Da/Db
<ul style="list-style-type: none"> <li>• Lower range value and measuring span</li> <li>• Influence of power supply</li> </ul>	0.25 %/10 K of measuring span 0.005 %/V		EC type-examination certificate	SEV 10 ATEX 0146	
<b>Operating conditions</b>	Process temperature	-40 ... +120 °C (-40 ... +248 °F)	Connection to certified intrinsically-safe resistive circuits with maximum values:	U <sub>i</sub> ≤ 30 V DC; I <sub>i</sub> ≤ 100 mA; P <sub>i</sub> ≤ 0.75 W	
<ul style="list-style-type: none"> <li>• Ambient temperature</li> <li>• Storage temperature</li> <li>• Degree of protection (to EN 60529)</li> </ul>	-25 ... +85 °C (-13 ... +185 °F) -50 ... +100 °C (-58 ... +212 °F)	<ul style="list-style-type: none"> <li>• IP 65 with connector per EN 175301-803-A</li> <li>• IP 67 with device plug M12</li> <li>• IP 67 with cable</li> <li>• IP 67 with cable quick screw connection</li> </ul>	Effective internal inductance and capacity for versions with plugs per EN 175301-803-A and M12	L <sub>i</sub> = 0 nH; C <sub>i</sub> = 0 nF	
Electromagnetic compatibility		<ul style="list-style-type: none"> <li>• acc. IEC 61326-1/-2/-3</li> <li>• acc. NAMUR NE21, only for ATEX versions and with a max. measuring deviation ≤ 1 %</li> </ul>	CSA <sup>2)</sup>	70006348	Class I, Division I, Groups A, B, C and D; Class II, Division 1, Groups E, F and G, Class III Class I, Division 2, Groups A, B, C and D; Class II, Division 2, Groups F and G, Class III A/Ex ia IIC T4 Ga/Gb A/Ex ia IIIC T125°C Da/Db

<sup>1)</sup> For variants with output signal 0 ... 5 V and ratiometric output available soon.

<sup>2)</sup> See ordering data for available versions.

**Pressure Measurement**

Pressure transmitters

Single-range transmitters for general applications

SITRANS P220 for gauge pressure

1

**Selection and ordering data**

**SITRANS P 220 pressure transmitters for gauge pressure, high-pressure and refrigeration applications, fully-welded version**

Accuracy typ. 0.25 %

Wetted parts materials: stainless steel

Non-wetted parts materials: stainless steel

Click on the Article No. for the online configuration in the PIA Life Cycle Portal.

Article No. Order code

7MF1567 - - A

Measuring range	Overload limit		Burst pressure		
	Mini- mum	Max.			

**For gauge pressure**

0 ... 2.5 bar (0 ... 36.3 psi)	-1 bar (-14.5 psi)	6.25 bar (90.7 psi)	25 bar (363 psi)		<b>3 BD</b>
0 ... 4 bar (0 ... 58 psi)	-1 bar (-14.5 psi)	10 bar (145 psi)	40 bar (870 psi)		<b>3 BE</b>
0 ... 6 bar (0 ... 87 psi)	-1 bar (-14.5 psi)	15 bar (217 psi)	60 bar (522 psi)		<b>3 BG</b>
0 ... 10 bar (0 ... 145 psi)	-1 bar (-14.5 psi)	25 bar (362 psi)	60 bar (870 psi)		<b>3 CA</b>
0 ... 16 bar (0 ... 232 psi)	-1 bar (-14.5 psi)	40 bar (580 psi)	96 bar (1392 psi)		<b>3 CB</b>
0 ... 25 bar (0 ... 363 psi)	-1 bar (-14.5 psi)	62.5 bar (906 psi)	150 bar (2176 psi)		<b>3 CD</b>
0 ... 40 bar (0 ... 580 psi)	-1 bar (-14.5 psi)	100 bar (1450 psi)	240 bar (3481 psi)		<b>3 CE</b>
0 ... 60 bar (0 ... 870 psi)	-1 bar (-14.5 psi)	150 bar (2175 psi)	360 bar (5221 psi)		<b>3 CG</b>
0 ... 100 bar (0 ... 1450 psi)	-1 bar (-14.5 psi)	250 bar (3625 psi)	600 bar (8702 psi)		<b>3 DA</b>
0 ... 160 bar (0 ... 2320 psi)	-1 bar (-14.5 psi)	400 bar (5801 psi)	960 bar (13924 psi)		<b>3 DB</b>
0 ... 250 bar (0 ... 3625 psi)	-1 bar (-14.5 psi)	625 bar (9064 psi)	1500 bar (21756 psi)		<b>3 DD</b>
0 ... 400 bar (0 ... 5801 psi)	-1 bar (-14.5 psi)	1000 bar (14503 psi)	2400 bar (34809 psi)		<b>3 DE</b>
0 ... 600 bar (0 ... 8702 psi)	-1 bar (-14.5 psi)	1500 bar (21755 psi)	3600 bar (52200 psi)		<b>3 DG</b>
0 ... 1000 bar (0 ... 14500 psi)	-1 bar (-14.5 psi)	1500 bar (21755 psi)	5000 bar (72520 psi)		<b>3 EA</b>

Other version, add Order code and plain text:  
Measuring range: ... up to... bar (psi)

**9 AA H 1 Y**

**Measuring ranges for gauge pressure**

0 ... 30 psi	-14.5 psi	75 psi	360 psi	*	<b>4 BE</b>
0 ... 60 psi	-14.5 psi	150 psi	580 psi	*	<b>4 BF</b>
0 ... 100 psi	-14.5 psi	250 psi	580 psi	*	<b>4 BG</b>
0 ... 150 psi	-14.5 psi	375 psi	870 psi	*	<b>4 CA</b>
0 ... 200 psi	-14.5 psi	500 psi	1390 psi	*	<b>4 CB</b>
0 ... 300 psi	-14.5 psi	750 psi	2170 psi	*	<b>4 CD</b>
0 ... 500 psi	-14.5 psi	1250 psi	3481 psi	*	<b>4 CE</b>
0 ... 750 psi	-14.5 psi	1875 psi	5220 psi	*	<b>4 CF</b>
0 ... 1000 psi	-14.5 psi	2500 psi	5220 psi	*	<b>4 CG</b>
0 ... 1500 psi	-14.5 psi	3750 psi	8700 psi	*	<b>4 DA</b>
0 ... 2000 psi	-14.5 psi	5000 psi	13920 psi	*	<b>4 DB</b>
0 ... 3000 psi	-14.5 psi	7500 psi	21750 psi	*	<b>4 DD</b>
0 ... 5000 psi	-14.5 psi	12500 psi	34800 psi	*	<b>4 DE</b>
0 ... 6000 psi	-14.5 psi	15000 psi	34800 psi	*	<b>4 DF</b>
0 ... 8700 psi	-14.5 psi	21755 psi	52200 psi	*	<b>4 DG</b>
0 ... 14500 psi	-14.5 psi	21755 psi	72520 psi	*	<b>4 EA</b>

Other version, add Order code and plain text: Measuring range: ... up to ... psi

**9 AA H 1 Y**

**Output signal**

4 ... 20 mA; two-wire system; power supply 7 ... 33 V DC (10 ... 30 V DC for ATEX versions)	<b>0</b>
0 ... 10 V; three-wire system; power supply 12 ... 33 V DC	<b>10</b>
0 ... 5 V; 3-wire system; auxiliary power 7 ... 33 V DC	<b>20</b>
Ratiometric 10 ... 90 %; 3-wire system; auxiliary power 5 V DC ± 10 %	<b>30</b>

**Explosion protection (only 4 ... 20 mA)**

None	<b>0</b>
With explosion protection Ex ia IIC T4	<b>1</b>

**Electrical connection**

Connector per DIN EN 175301-803-A, stuffing box thread M16 (with coupling)	*	<b>1</b>
Device plug M12 per IEC 61076-2-101		<b>2</b>
Connection via fixed mounted cable, 2 m (not for type of protection "Intrinsic safety i")		<b>0 3</b>
Quickon cable quick screw connection PG9 (not for type of protection "Intrinsic safety i")		<b>0 4</b>
Connector per DIN EN 175301-803-A, stuffing box thread 1/2"-14 NPT (with coupling)	*	<b>5</b>
Connector per DIN EN 175301-803-A, stuffing box thread PG11 (with coupling)	*	<b>6</b>
Fixed mounted cable, length 5 m		<b>0 7</b>
Special version		<b>9</b>

\* Order code E21 required for complete configuration with CRN and cCSA<sub>US</sub> Ex approval.

**N 1 Y**

## Pressure Measurement

Pressure transmitters

Single-range transmitters for general applications

1

### SITRANS P220 for gauge pressure

#### Selection and ordering data

#### SITRANS P 220 pressure transmitters for gauge pressure, high-pressure and refrigeration applications, fully-welded version

Accuracy typ. 0.25 %

Wetted parts materials: stainless steel

Non-wetted parts materials: stainless steel

#### Process connection

G1/2" male per EN 837-1 (1/2" BSP male) (standard for metric pressure ranges mbar, bar)

G1/2" male thread and G1/8" female thread

G1/4" male per EN 837-1 (1/4" BSP male)

7/16"-20 UNF male

1/4"-18 NPT male (standard for pressure ranges inH<sub>2</sub>O and psi) \*

1/4"-18 NPT female

1/2"-14 NPT male

1/2"-14 NPT female (Only for measuring ranges ≤ 60 bar (870 psi))

7/16"-20 UNF female

M20x1.5 male

G1/4" to DIN 3852 Form E

G1/2" to DIN 3852 Form E

Special version

#### Version

Standard version \*

#### Further designs

Supplement the Article No. with "-Z" and add Order code.

Quality test certificate, 5-point factory calibration (IEC 60770-2)  
(not possible for measuring ranges > 0 ... 600 bar/0 ... 8 702 psi)

Oxygen version, free of oil and degreased (not in conjunction with explosion protection version)

With CRN and cCSA<sub>US</sub> Ex approval (only for measuring ranges 0 ... 30 psi bis 0 ... 8 700 psi)

\* Order code E21 required for complete configuration with CRN and cCSA<sub>US</sub> Ex approval..

Article No. Order code

7MF1567 - - - - - A

A

B

C

D

E

F

G

H

J

P

Q

R

Z P1Y

1

C11

E10

E21

**Dimensional drawings**

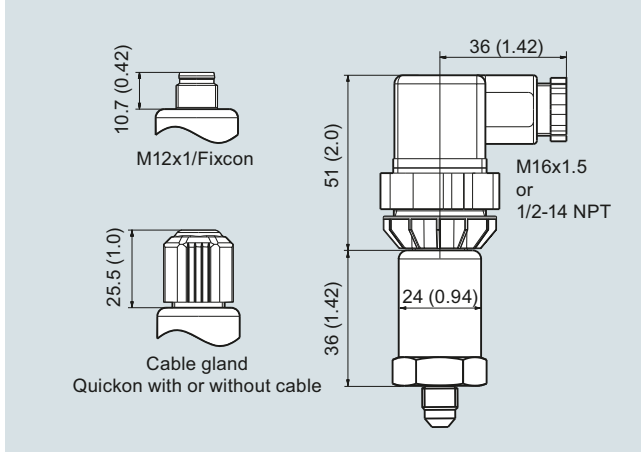

SITRANS P220, electrical connections, dimensions in mm (inch)

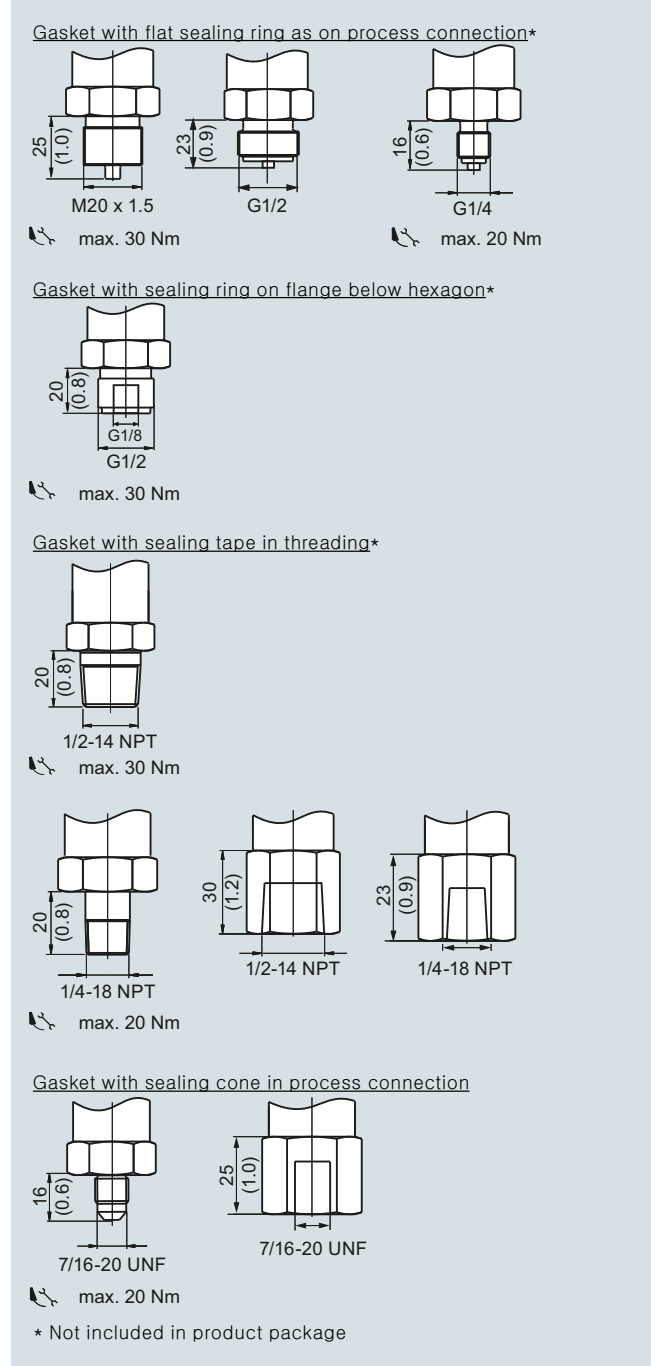

SITRANS P220, process connections, dimensions in mm (inch)



## Pressure Measurement

Pressure transmitters

Single-range transmitters for general applications

1

### SITRANS P220 for gauge pressure

#### Schematics

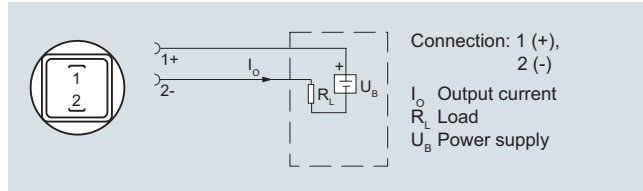

Connection with current output and connector per EN 175301

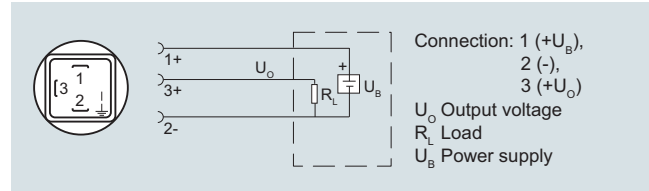

Connection with voltage output, ratiometric output and plug according to EN 175301

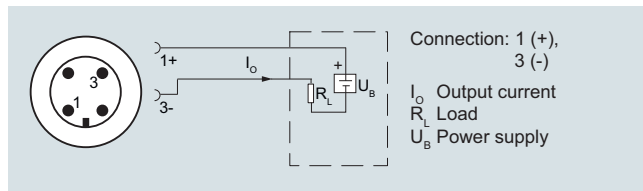

Connection with current output and device plug M12x1

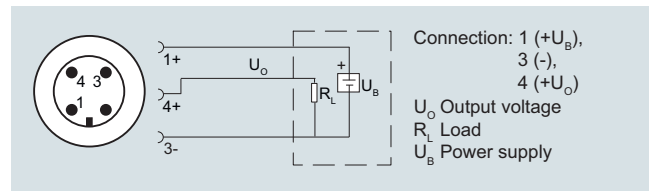

Connection with voltage output, ratiometric output and device plug M12x1

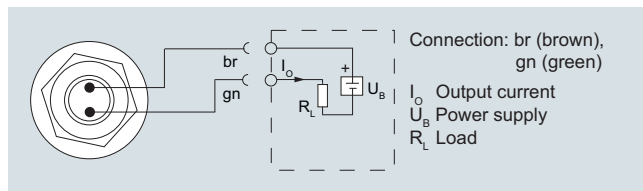

Connection with current output and cable

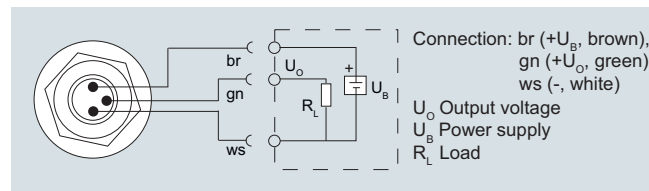

Connection with voltage output, ratiometric output and cable

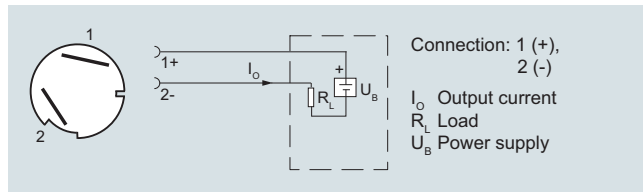

Connection with current output and cable quick screw connection Quickon

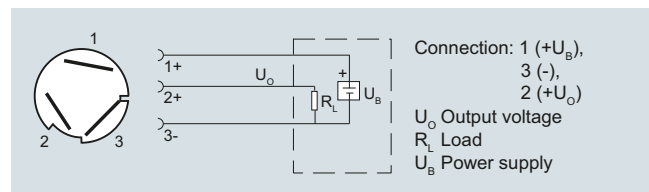

Connection with voltage output, ratiometric output and Quickon fast cable termination

#### Version with explosion protection: 4 ... 20 mA

The grounding connection is conductively bonded to the transmitter enclosure

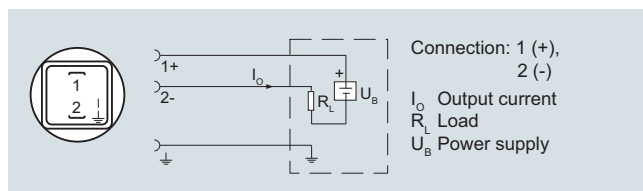

Connection with current output and connector per EN 175301 (Ex)

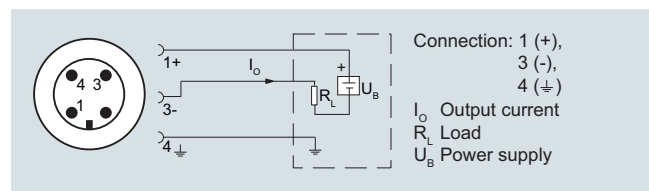

Connection with current output and device plug M12x1 (Ex)