

Nemo SX - Multifunction control module

Cat. N°: SXM0C1



Contents	Pages
1. Description - Use	1
2. Range.....	1
3. Overall dimensions	1
4. Preparation - Connection.....	1
5. General characteristics	6
6. System architectures	9
6.1 Stand Alone.....	9
6.1.1 with local addressing	9
6.1.2 with remote addressing	10
6.2 Supervised	11
6.2.1 with local addressing	11
6.2.2 with remote addressing	13
7. Compliance and approvals	15

1. DESCRIPTION - USE

- . Module dedicated to Nemo SX System.
- . Enables to remotely command different electrical loads and motor driven control modules of modular devices (MCBs, RCCBs, RCBOs...) or power devices (e.g. MCCBs...).
- . Equipped with DIP switches (on the side) allowing product configuration of:
 - contacts type (NO or NC contacts)
 - working method (maintained or momentary contact)

Symbol:

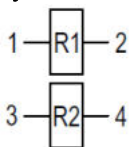

2. RANGE

- . Cat. n° SXM0C1: Universal Control Module, with 2 configurable relays 250 V~ -6 A contacts

Width:

- . 1 module. 17,8 mm width.

3. OVERALL DIMENSIONS

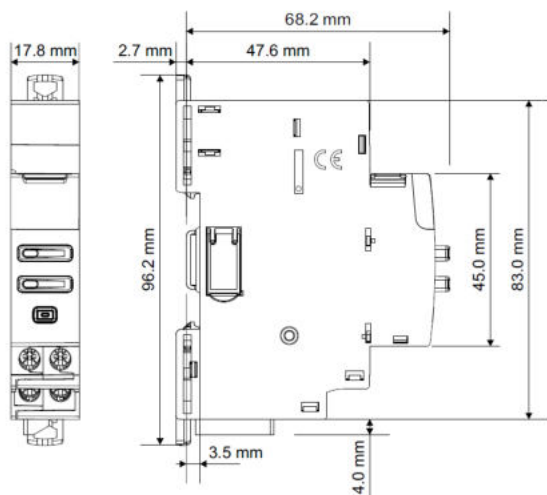

4. PREPARATION -CONNECTION

Fixing:

- . On symmetric rail EN/IEC 60715 or DIN 35 rail

Operating positions:

- . Vertical, Horizontal, Upside down, On the side



Power Supply:

- . Mandatory in 12 V d.c. via the specific Power supply module Cat n° SXAA230
- . Two ways:
 - via specific communication patch cords (cat. nos SXAC250/500/1000) to connect at the downstream through dedicated ports



- via specific communication rails (cat. nos SXAR18/24/36) to connect at the rear through dedicated connectors.

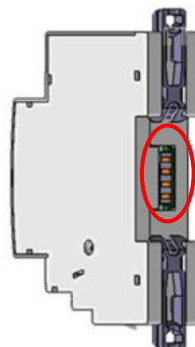

Nemo SX - Multifunction control module

Cat. N°: SXM0C1

4. PREPARATION –CONNECTION (continued)

Terminals:

- . Terminal depth: 8 mm.
- . Stripping length: 8 mm

Screw head:

- . Mixed, slotted and Pozidriv n°1 (UNI7596 type Z1).

Recommended tightening torque:

- . 1 Nm.

Recommended tools:

- . For the terminals: Pozidriv n°1 or flat screwdriver 4 mm.
- . For fixing: flat screwdriver 5.5 mm (6 mm maximum).
- . For configuration DIP switches: flat screwdriver 2 mm

Conductor type:

	Copper cable	
	Without ferrule	With ferrule
Rigid Cable	1 x 0,5 mm ² to 1,5 mm ² 2 x 1,5 mm ²	-
Flexible Cable	1 x 0,5 mm ² to 1,5 mm ² 2 x 1,5 mm ²	1 x 0,5 mm ² to 1,5 mm ² 2 x 1,5 mm ²

Wiring diagrams:

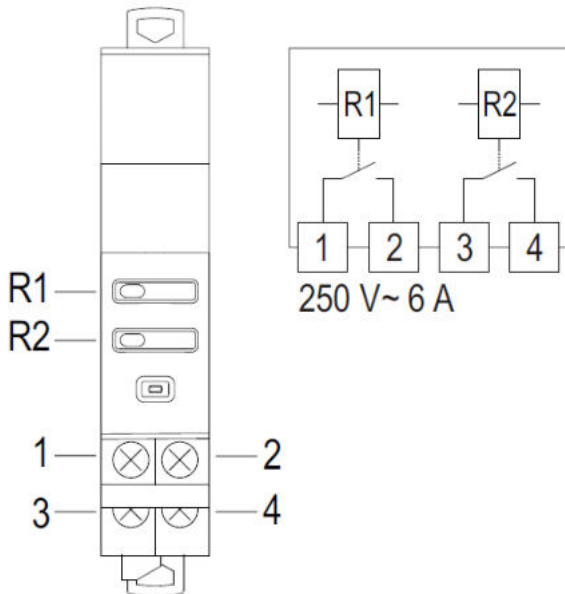

- . Pushbutton R1: controls the relay between terminals 1 and 2
- . Pushbutton R2: controls the relay between terminals 3 and 4
- . Both relays are configurable. Refer to § "Module Configuration"

4. PREPARATION –CONNECTION (continued)

Module configuration:

- . On the left side the Nemo SX module is equipped with 4 DIP switches allowing configuration of:
 - Contacts type (NO or NC contacts)
 - Working method (maintained or momentary contact)
- Dipswitches may be manipulated by a screwdriver

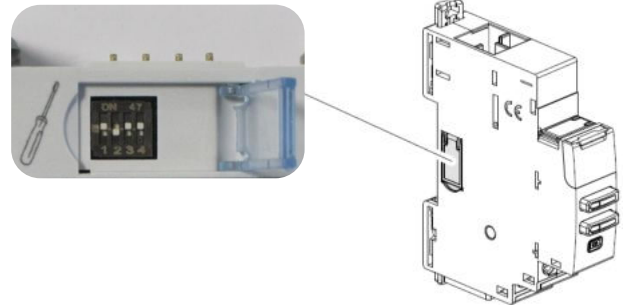

- . Default configuration (switch in 0000 position)

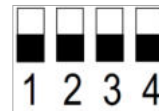

According to the function you want to assign to the module, lateral DIP switch must mandatory be manually auctioned as shown below

If the DIP switch remain in 0000 position, module configuration will display "generic" information (output "active" or "non-active") linked to the 2 outputs state

- . Table of possible configurations:

Generic outputs

[more configuration on next page]

Nemo SX - Multifunction control module

Cat. N°: SXM0C1

4. PREPARATION –CONNECTION (continued)

Module configuration (continued):

Nemo SX device associated with Motor driven control modules

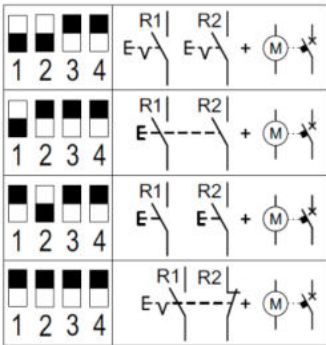

Nemo SX device associated with Latching relays or Contactors

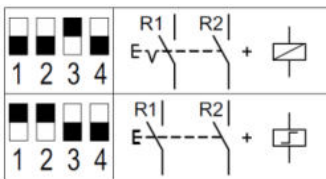

Note:

	NO contact Impulsive command
	NC contact Impulsive command
	NO contact Maintained command
	NC contact Maintained command
-----	Contacts interlocked
	Motor Driven control module

4. PREPARATION –CONNECTION (continued)

Connection with an associated device:

. Association with Motor Driven Control module with ON/OFF separated commands

. Lateral DIP-switches of the Nemo SX module must mandatory be configured as shown

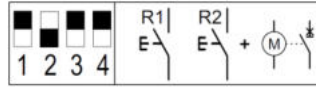

. Wiring diagram:

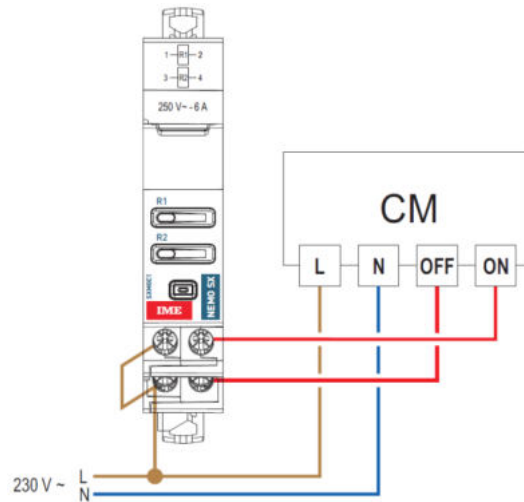

. Association with Motor Driven Control module with ON/OFF cyclic command

. Lateral DIP-switches of the Nemo SX module must mandatory be configured as shown

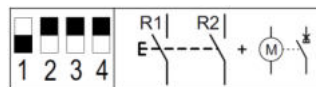

. Wiring diagram:

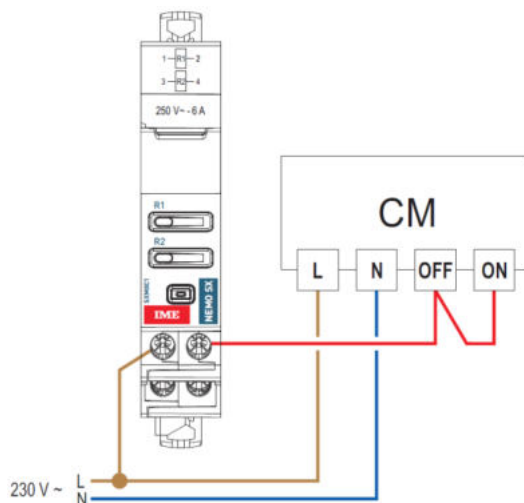

Nemo SX - Multifunction control module

Cat. N°: SXM0C1

4. PREPARATION –CONNECTION (continued)

Connection with an associated device (continued):

. Association with Latching relay

. Lateral DIP-switches of the Nemo SX module must mandatory be configured as shown

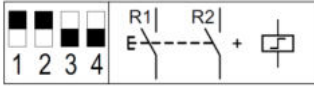

. Wiring diagram:

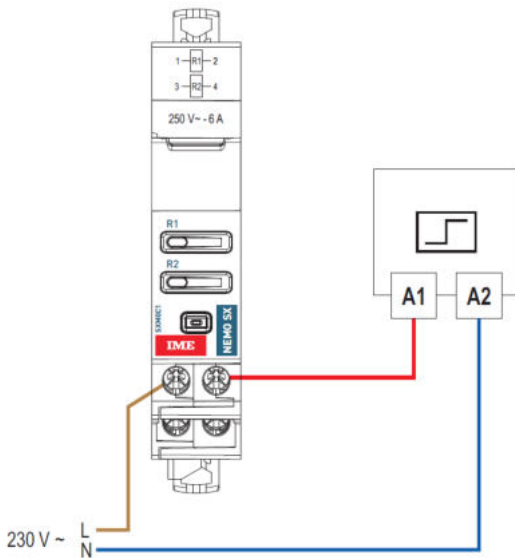

. Association with Contactors

. Lateral DIP-switches of the Nemo SX module must mandatory be configured as shown

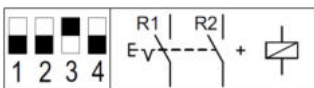

. Wiring diagram:

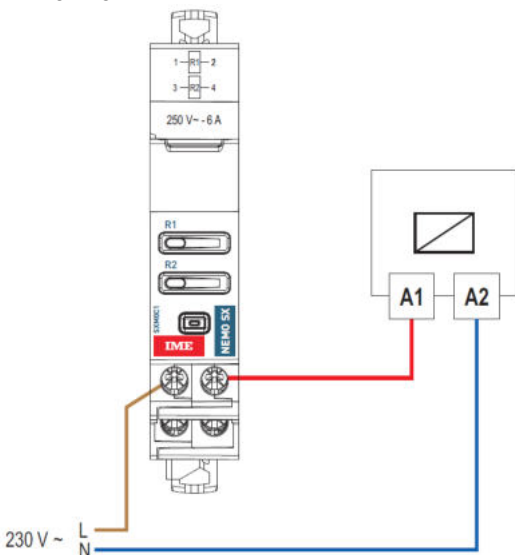

Note: whatever the configuration given to the Nemo SX Multifunction command module, local command of the module is still possible pushing on the 2 button on the front face of the module;

4. PREPARATION –CONNECTION (continued)

Data connection (Nemo SX modules inter-connection):

. Via specific communication patch cords (cat. nos SXAC250/500/1000)



Allow data transmission between the different Nemo SX modules. This type of connection is recommended when there are few Nemo SX modules, distributed all over the enclosure.

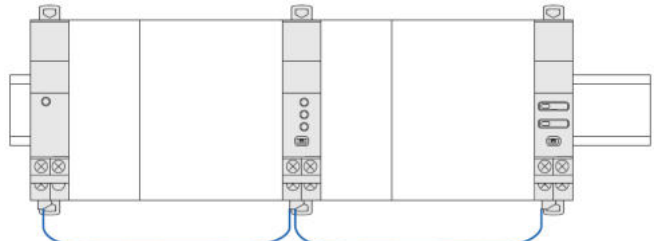

Implementing: with this configuration, the plastic protection cover of the backside communication ports on the Nemo SX module must be keep on.

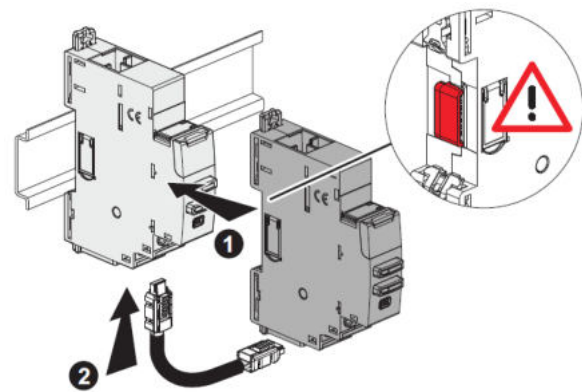

Nemo SX - Multifunction control module

Cat. N°: SXM0C1

4. PREPARATION –CONNECTION (continued)

Data connection (Nemo SX modules inter-connection) (continued):

. Via specific communication rails (cat. nos SXAR18/24/36).



. Allow data transmission between the different Nemo SX modules. This type of connection is recommended when there are several Nemo SX modules on the same DIN row.

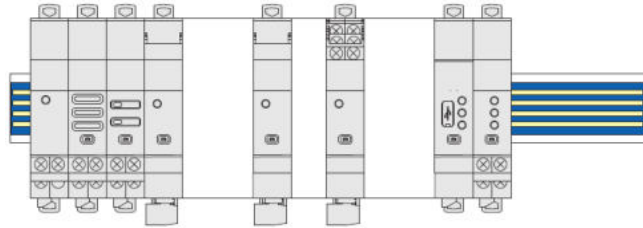

Implementing: with this configuration, the plastic protection cover of the backside communication ports on the Nemo SX module must be removed.

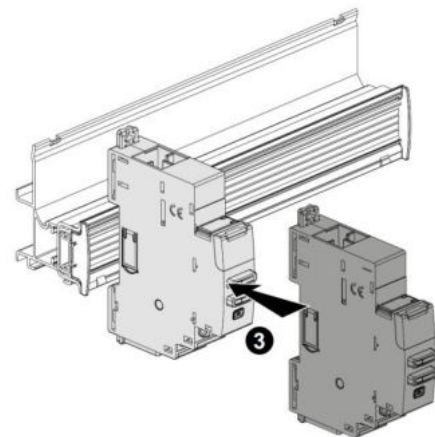
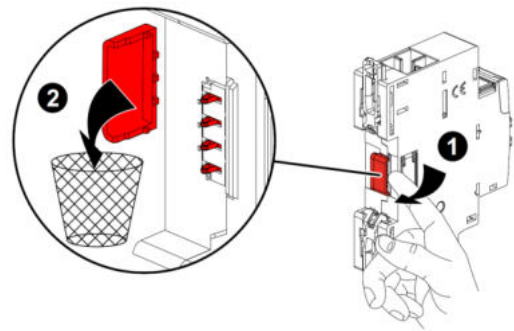

4. PREPARATION –CONNECTION (continued)

Data connection (Nemo SX modules inter-connection) (continued):

. Via a mix between specific communication patch cords and communication rails in order to create a link between several rows

Two situations:

- Individually connected with communication rails. The communication patch cord allows to connect two rows.

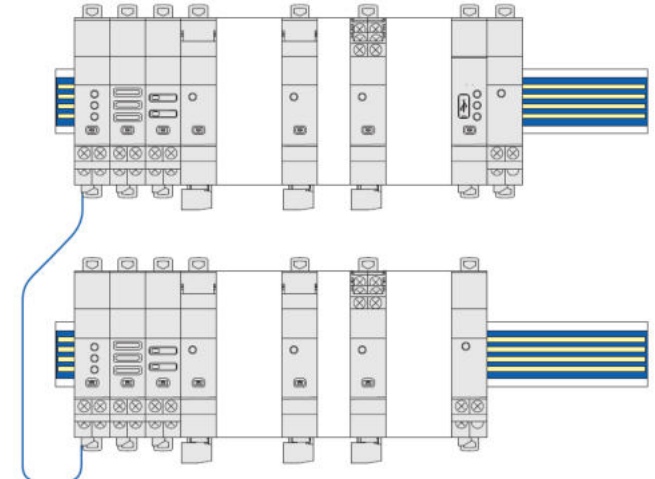

- Individually connected with communication patch cords & communication rail. The communication patch cords allow to connect Nemo SX module on a row and to connect two rows.

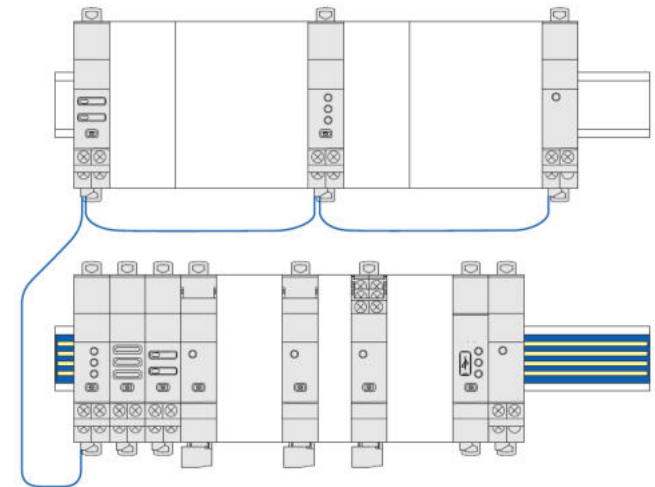

Nemo SX - Multifunction control module

Cat. N°: SXM0C1

5. GENERAL CHARACTERISTICS

Front face marking:

. By permanent ink pad printing (red line) and laser marking

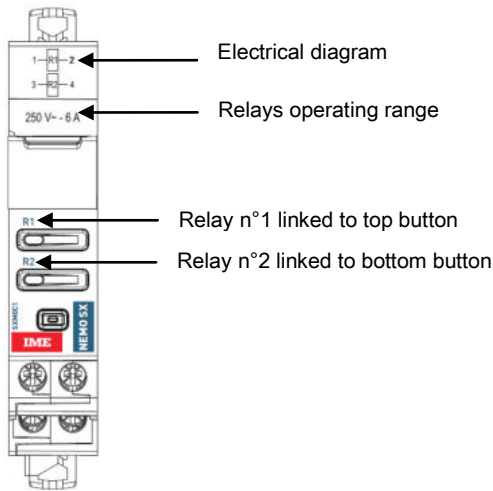

Lateral side marking:

. By laser.

left side: Standard and programming information

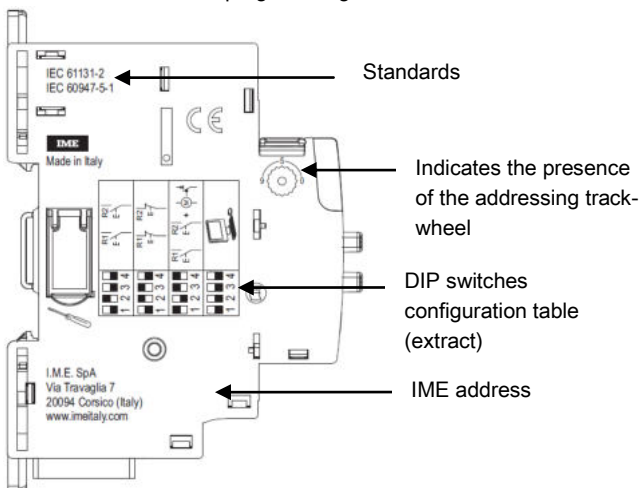

right side: cabling and traceability information

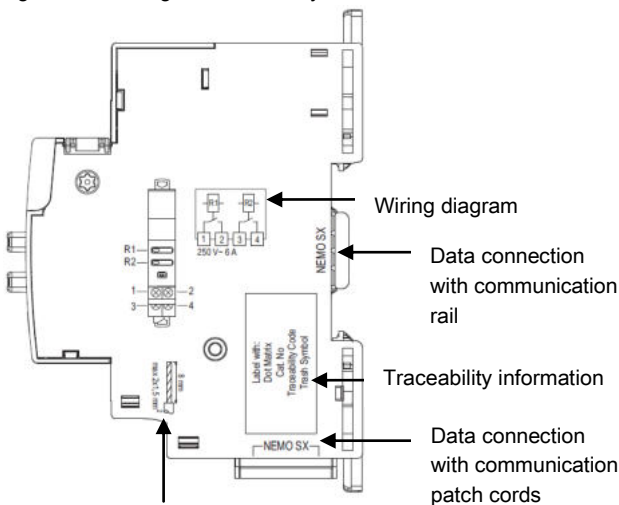

Cabling information

5. GENERAL CHARACTERISTICS (continued)

Pushbutton:

- . Equipped with LED with two possible colours:
 - Steady green → the corresponding relay is inactive (relay not power supplied)
 - Steady red → the corresponding relay is power supplied
 - Blinking (red or green) → the Nemo SX universal command module has received a command but not been executed yet. This is the case of programmed activation time-delay (the delay time is settable only with the remote addressing. See §6). The led stay blinking until the command is executed. Then becomes steady red or green according to the state of the relay.

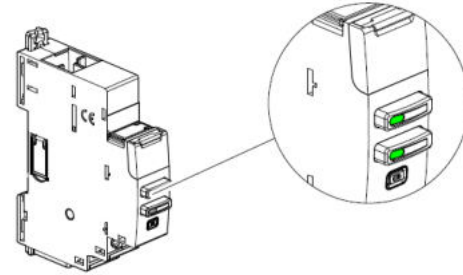

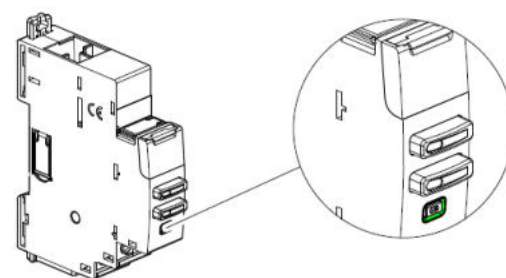

Multi-Functions button:

. Front face button as several functions:



. Give information about the operating state on the module
Possible states:

Led color	State	Meaning
 red	Slow blinking	Error (e.g. addressing error)
	Fast blinking	No function
 green	Steady (pressing the multi function button longer than 20 sec.)	Total reset [any firmware updates are preserved]
	Slow blinking	System process is running. Wait until the Led turns steady
	Fast blinking (pressing the multi function button for 10 sec.)	put in "Stand-by" the Nemo SX module (no remote action and communication available)
 orange	Steady	System OK, connection is running
	Slow blinking	No function
	Fast blinking	Device's firmware update in progress
	Steady	No function

5. GENERAL CHARACTERISTICS *(continued)*

Relays operating voltage:

. Ue = 250 V ~

Relays rated current:

. In = 6 A @ cosφ = 1

Rated frequency :

. 50/60 Hz with standard tolerances.

Insulation voltage:

. Ui = 400 V

Impulse withstand voltage Uimp:

. Nemo SX ports / Relay terminals:
wave 1,2 / 50 μs: 6 kV
alternate current 50 Hz / 1 min.: 3 kV
. Relay terminal 1 / Relay terminal 2:
wave 1,2 / 50 μs: 4 kV
alternate current 50 Hz / 1 min.: 1,9 kV

Pollution degree:

. 2 according to IEC/EN 60898-1.

Overvoltage category :

. III

Dielectric strength:

. 2500 V

Mechanical endurance:

. Min. 10 x 10⁶ operations.

Utilization category :

. AC15: electromagnetic load, according to IEC 60947-5-1

Plastic material:

. Self-extinguishing polycarbonate.
. Heat and fire resistant according to IEC/EN 60695-2-12, glow-wire test at 960°C.
. Classification UL 94 / IECEN 60695-11-10: V1

Ambient operating temperature:

. Min. = -25°C. Max. = +70°C

Ambient storage temperature:

. Min. = -40°C. Max. = +70°C

Protection Index:

. Protection index of terminals against direct contacts: IP2X (IEC/EN 60529).
. Protection index of terminals against solid and liquid bodies (wired device): IP 20 (IEC/EN 60529).
. Protection index of the front face against solid and liquid bodies: IP 40 (IEC/EN 60529).
. Class II, front panel with faceplate.

5. GENERAL CHARACTERISTICS *(continued)*

Average weight per device:

. 0,065 kg.

Volume when packed:

. 0,21 dm³.

Consumption:

. Values at 12 Vd.c.

Configuration	W	mA
Stand-by	0,265	22
2 Open contacts	0,265	22
1 Open contact & 1 Closed contact	0,375	31
2 Closed contacts	0,458	38

5. GENERAL CHARACTERISTICS *(continued)*

Load shedding Function:

. Allows to automatically carry out load shedding in case of power demand when a circuit exceeds a threshold.

. Function is implementable using together following Nemo SX modules:

- Multifunction Control module (cat. no SXM0C1) with DIP-switches on 0000 position (see § "Module configuration")
- Measurement modules (cat. nos SXMM63, SXMT63, SXMMT5)

To set the different parameters it is necessary to use the Nemo SX Configuration software (available online for free)

. Procedure:

1. Assign the same address to the Nemo SX modules (Multifunction control and Measurement modules) which require to be linked
2. Connect a computer to the Modbus/Nemo SX interface or to the Mini configuration module (according to the system architecture type; see § "System architectures")
3. In the Nemo SX Configuration software pages adjust the parameters:

. In the dedicated page of the Measurement module:

- **Threshold:** value of Total active power (kW) above which procedure starts. *(default value 100 kW)*
- **Hysteresis:** value expressed in % of the threshold under which the alarm is over and the disconnected loads are restored. *(default value 5%)*
- **Alarm delay (s)** - *(default value 1s, min value 0 s, max. value 32767s):*
during the activation of an alarm: is the waiting time between the threshold point and the alarm on the Nemo SX bus
during the de-activation of an alarm: is the waiting time between the hysteresis point and the alarm is deactivation on the Nemo SX bus

. In the dedicated page of the Universal control module:

- **Relay normal state:** the rest position of the relay; normally open (NO) or normally closed (NC).
- **Relay activation:** impulsive or maintained
- **Relay activation time (s):** used for the impulsive work method; represents the time in which the relay remains in the working position *(default value 1s, max. value 32767s)*.
- **Activation delay (s):** waiting time between the alarm on the Nemo SX bus and the action done by the universal control module *(default value 0s, max. value 32767s)*.

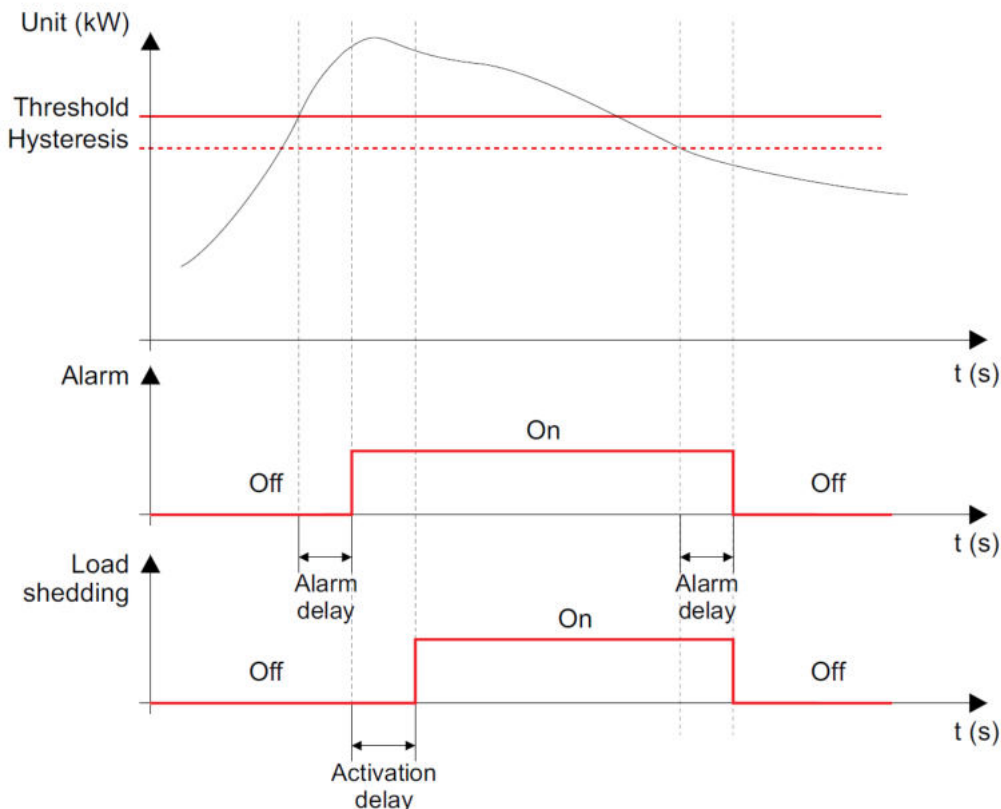

6. SYSTEM ARCHITECTURES

The Nemo SX is a polyvalent system and, according to the needs of the customer, can be set up and/or used as “Stand-alone” or “Supervised” system. Based on this choice the configuration and addressing methods are different.

Four possible architectures are provided:

6.1 Stand alone system

6.1.1 with local addressing (through the track wheel)

6.1.2 with remote addressing (through a computer)

6.2 Supervised (Computer Supervisory System)

6.2.1 with local addressing

6.2.2 with remote addressing

6.1 Stand-alone system

. **Stand alone** = autonomous system. To be used by the end-user if it is not necessary to have a computer for the supervision outside the envelope. Everything can be manage on site.

6.1.1 Stand-alone system with local addressing (through the track wheel)

Local addressing advantages:

- No configuration software needed to set-up the installation
- **It is not necessary to use a computer to manage settings** (configurations, test, ...) and to use the system (visualize and be alerted, ...). Everything can be done through the Mini configuration module (local display, cat. no SXV01). [Refer to the technical sheet dedicated to this module for details].
- No communication Interfaces or gateways are required.
- Installation can be done without the intervention of a System Integrator

Programming procedure:

. For Nemo SX modules which need some: mandatory through to lateral DIP-switch of each Nemo SX modules (see § "Module configuration" in the technical sheet of each device).

Addressing procedure:

. For all Nemo SX modules: mandatory through the track wheel located on the top upper face of each Nemo SX modules
. Marked from 0 to 9 in order to locally define the Modbus address of the Nemo SX modules

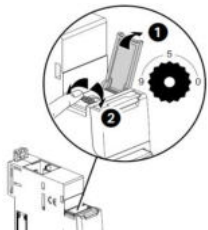

Consequences of the local addressing mode (through the track wheel):

- . Each device of the system must be addressed.
- . Addresses available: from 1 to 9
- . Address 0 not permitted
- . It is possible to assign to several devices the same address with the purpose of grouping different functions, **because they are related to the same electrical circuit**. For example it is possible to assign the same address to a multifunction signalling module (cat. no SXMC02), a multifunction control module (cat. no SXM0C1), a measuring module, and so on. In this way on the Nemo SX mini configuration module (local display) the grouped function will be displayed as a unique “device” with all grouped functions. [Refer to the schemes hereunder]

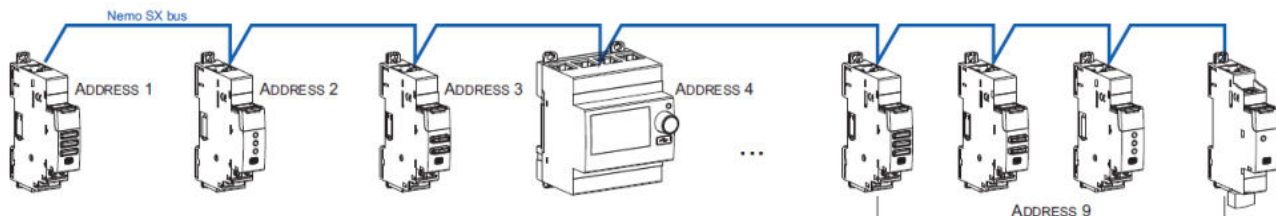

Note for the mini configuration module (local display)

- . It is possible to assign it the same address as another Nemo SX through the programming menu of the device
- . The mini configuration module can be placed everywhere in the Nemo SX bus

6. SYSTEM ARCHITECTURES

6.1 Stand-alone system *(continued)*

6.1.2 Stand-alone system with remote addressing (through a computer)

Remote addressing advantages:

- Whole configuration (addresses and functions) can be set up through the Nemo SX Configuration software
- Configuration software available for free
- **Automatic detection of the Nemo SX modules** installed in the system (characteristics, functions, configuration...)
- **Increased settings possibilities: load shedding function**
- Increased addressing: **up to 30 Modbus addresses in a system**

Programming procedure:

. For Nemo SX modules which need some: mandatory through to lateral DIP-switch of each Nemo SX modules *(see § "Module configuration" in the technical sheet of each device)*.

Addressing procedure:

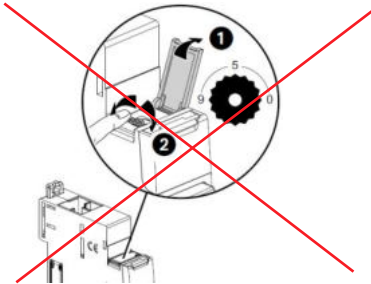

. It is not necessary to address the Nemo SX modules. The track wheel must be left in default position "0".

. All the addressing/configuring procedure will be done with the Configuration Software (available online for free)

. With remote addressing, the software does the automatic detection of modules installed in the system but the supervision is not possible until the user assign the remote address and all the characteristics to each module.

Note: it is mandatory to connect the computer to the mini configuration module with a "Type B" micro USB - USB cable. *[For more details, refer to the technical sheet dedicated to this module].*

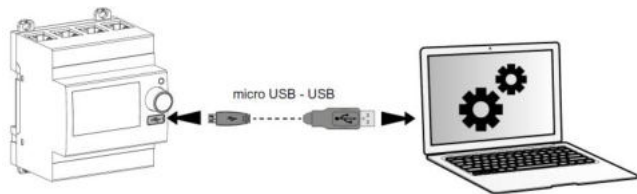

Read configuration from USB

Found: 7 modules
0 groups

Group modules in sets assigning the same address.
Press "Continue" to save addressing and import configuration.

Found modules				
	Model	Module ID	Address	Result
	SX1485	EMS/RS485 interface	0000-0000-00TE-123A	< 1 > ✓
	SXMC22	State (contact+fault)	FFFF-FFFF-FFFF-PC08	< 3 > ✓
	SXMM63	Measure (singlephase 63A)	FFFF-FFFF-FFFF-PC08	< 2 > ✓
	SXMM79	Measure (CT)	FFFF-FFFF-FFFF-PC01	< 4 > ✓
	SXMC1	Control (motor driver)	FFFF-FFFF-FFFF-PC01	< 2 > ✓
	SXMT63	Measure (threephase 63A)	FFFF-FFFF-FFFF-PC00	< 3 > ✓
	SXMM4P	Measure (pulse)	FFFF-FFFF-FFFF-PC08	< 4 > ✓
	SXMC22	State (contact+fault)	FFFF-FFFF-FFFF-FFFF	< 2 > ✓

Click on this icon on the table to make the LED blink on the corresponding module

Rotary addr. Refresh Continue

6. SYSTEM ARCHITECTURES

6.1 Stand-alone system (continued):

6.1.2 Stand-alone system with remote addressing (through a computer) (continued):

Consequences for the system architecture:

- for 1 mini configuration module (cat. no SXV01)
 - o up to **30 Nemo SX modules** (eg. 30 devices grouped per functions with addresses from 1 to 30)

It is possible to assign to several devices the same address with the purpose of grouping different functions, **because they are related to the same electrical circuit**. For example it is possible to assign the same address to a multifunction signalling module (cat. no SXMC02), a multifunction control module (cat. no SXM0C1), a measuring module, and so on. In this way on the Nemo SX display or in a supervision system the grouped function will be displayed as a unique “device” with all grouped functions. [Refer to the schemes here under]

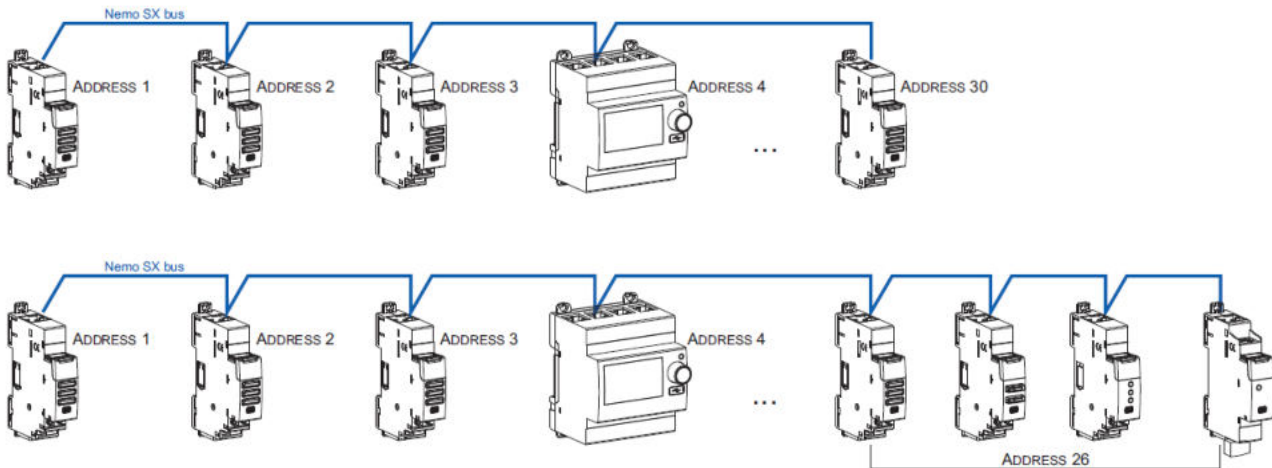

Note for the mini configuration module (local display)

- . It is possible to assign it the same address as another Nemo SX
- . The mini configuration module can be placed everywhere in the Nemo SX bus

6.2 Supervised system (Computer Supervisory System)

. **Supervised system** = System to be used through a Computer Supervisory System to remotely read data from the Nemo SX devices and/or do operations on these devices (e.g. commands of a motor driven or contactor ...).

6.2.1 Supervised system-with local addressing (through the track wheel)

Local addressing advantages:

- No configuration software needed to set-up the installation
- Installation can be done without the intervention of a System Integrator

Programming procedure:

. For Nemo SX modules which need some: mandatory through to lateral DIP-switch of each Nemo SX modules (see § "Module configuration" in the technical sheet of each device).

Addressing procedure:

. For all Nemo SX modules: mandatory through the track wheel located on the top upper face of each Nemo SX modules

. Marked from 0 to 9 in order to locally define the Modbus address to Nemo SX modules

In this system the Modbus address of an Nemo SX module device or group of modules (several functions) is obtained considering the address of the interface Modbus/Nemo SX Interface as tenth and the address of a device or group of function as unit (e.g. Interface address 1 = 10 → address of module n°5 = Modbus address 15)

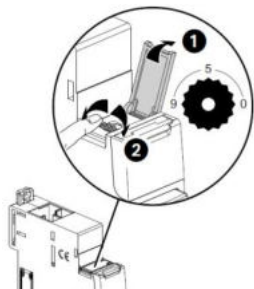

6. SYSTEM ARCHITECTURES *(continued)*

6.2 Supervised system (Computer Supervisory System) *(continued)*

6.2.1 Supervised system-with local addressing (through the track wheel) *(continued)*

Consequences of the local addressing mode (through the track wheel):

- . Each device of the system must be addressed.
- . Addresses available: from 1 to 9
- . Address 0 not permitted

It is possible to assign to several devices the same address with the purpose of grouping different functions, **because they are related to the same electrical circuit**. For example it is possible to assign the same address to a multifunction signalling module (cat. no SXMC02), a multifunction control module (cat. no SXM0C1), a measuring module, and so on. In this way on the Nemo SX display or in a supervision system the grouped function will be displayed as a unique "device" with all grouped functions. *[Refer to the scheme hereunder]*

Note: In this configuration the Modbus address of an Nemo SX module device or group of modules (several functions) is obtained considering the address of the interface Modbus/Nemo SX Interface as tenth and the address of a device or group of function as unit (e.g. Interface address 1 = 10 and device address = 5 → Modbus address = 15)

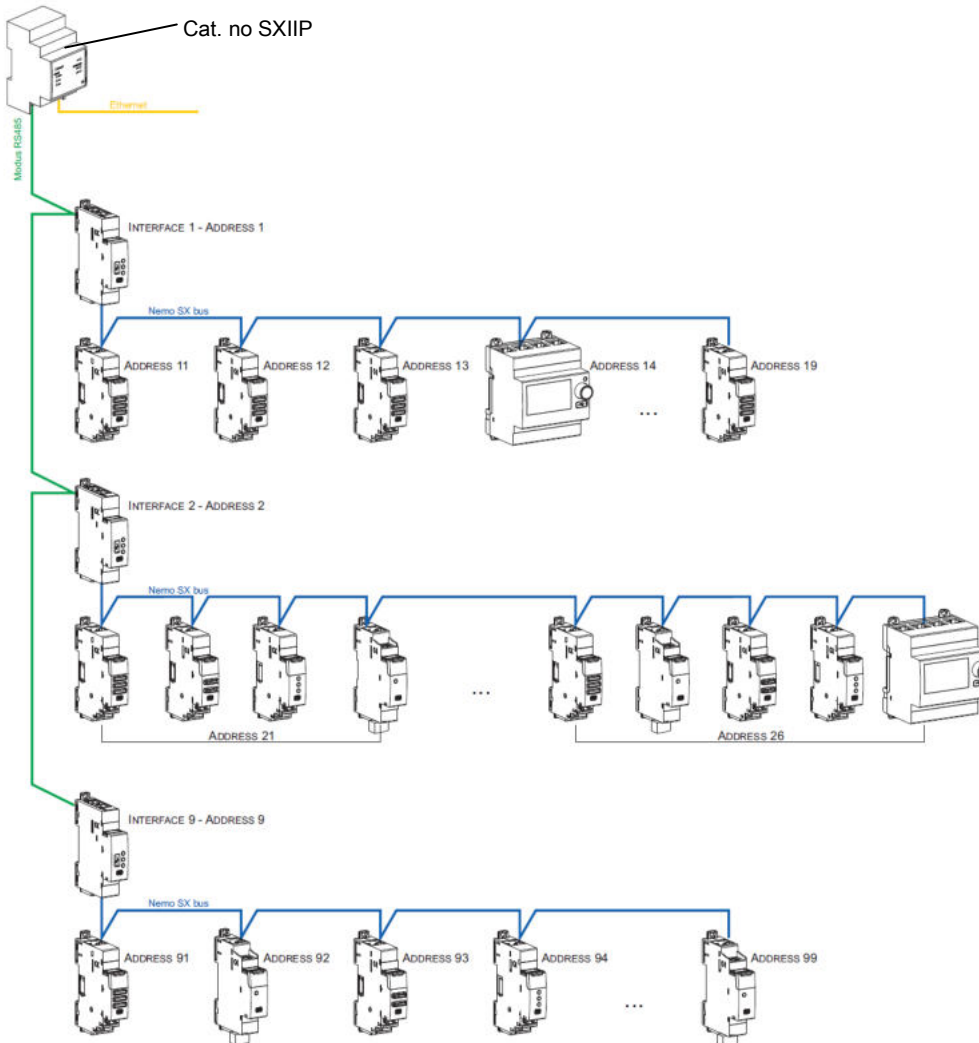

Consequences for the system architecture:

- for 1 IP/Modbus gateway (cat. no SXIIP):
 - o up to **81 Modbus address**
 - o mandatory limit of max. **9 Modbus/Nemo SX interfaces or max. 1000 m of Modbus cable** (cable Belden 9842, Belden 3106A or equivalent).
- for 1 Modbus/Nemo SX Interface (cat. no SXI485):
 - o up to **30 Nemo SX modules** (ex. 30 devices grouped per functions with addresses from 1 to 9)

Note: with local addressing, the Modbus/Nemo SX interface, does the automatic detection of modules (characteristics, functions, configuration...)

6. SYSTEM ARCHITECTURES *(continued)*

6.2 Supervised system (Computer Supervisory System) *(continued)*

6.2.2 Supervised system-with remote addressing (through a computer)

Remote addressing advantages:

- Whole of configuration (addresses and functions) can be done a remotely through the Nemo SX Configuration software
- Configuration software available for free
- **Automatic detection of the Nemo SX modules** installed in the system (characteristics, functions, configuration...)
- **Increased settings possibilities: load shedding function**
- Increased addressing: **up to 32 Modbus/Nemo SX interfaces**
- Increased addressing: **up to 247 Modbus addresses in a system**

Programming procedure:

. For Nemo SX modules which need some: mandatory through to lateral DIP-switch of each Nemo SX modules *(see § "Module configuration" in the technical sheet of each device)*.

Note: via the configuration software it is possible to assign all the functions and characteristics of each Nemo SX module

Addressing procedure:

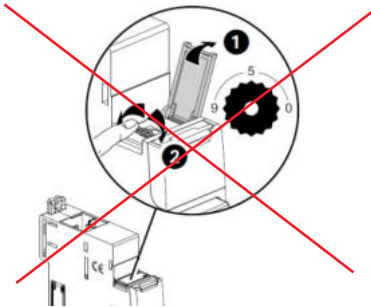

. It is not necessary to address the Nemo SX modules. The track wheel must be left in default position "0".

. A all the addressing/configuring procedure will be done with the Configuration Software (available online for free)

. With remote addressing, the software does the automatic detection of modules installed in the system but the supervision is not possible until the user assign the remote address and all the characteristics to each module.

Note: it is mandatory to connect the computer to the different Modbus/Nemo SX interface with a "Type B" micro USB - USB cable (one interface at a time). *[For more details, refer to the technical sheet dedicated to this module].*

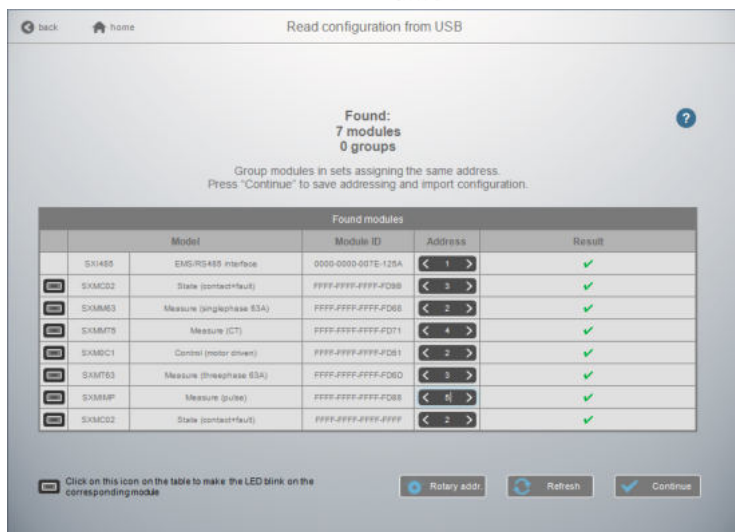
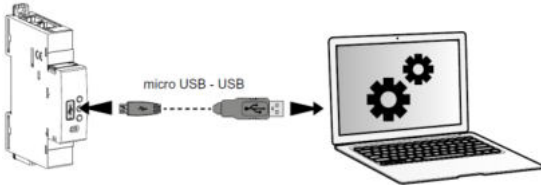

6. SYSTEM ARCHITECTURES *(continued)*

6.2 Supervised system (Computer Supervisory System) *(continued)*

6.2.2 Supervised system-with remote addressing (through a computer) *(continued)*

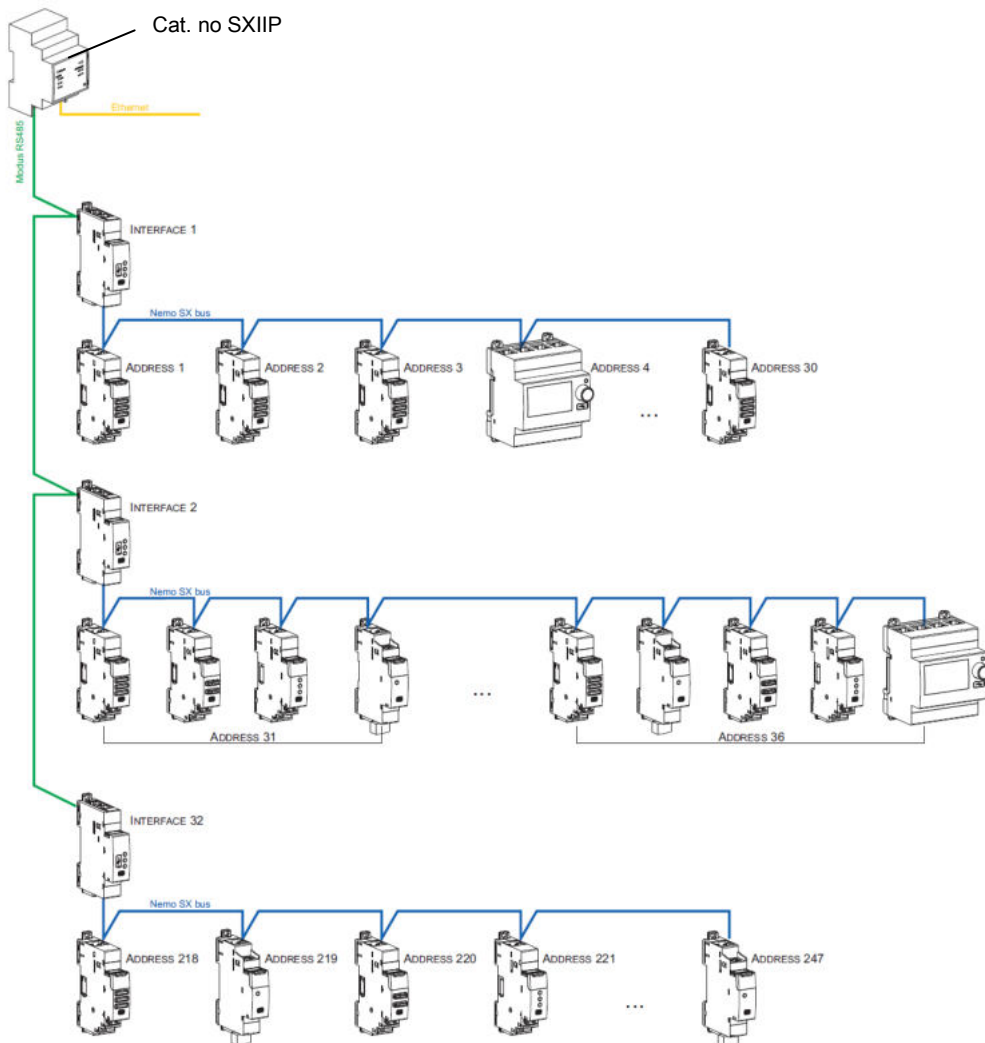

Consequences for the system architecture:

- for 1 IP/Modbus gateway (cat. no SXIIP):
 - o up to **247 Modbus address**
 - o Because of Modbus: mandatory limit of max. **32 Modbus/Nemo SX interfaces** or max. **1000 m of Modbus cable** (cable Belden 9842, Belden 3106A or equivalent).
- for 1 Modbus/Nemo SX Interface (cat. no SXI485):
 - o up to **30 Nemo SX modules or grouped modules** (e.g. 30 devices grouped per functions with addresses from 1 to 30)

It is possible to assign to several devices the same address with the purpose of grouping different functions, **because they are related to the same electrical circuit**. For example it is possible to assign the same address to a multifunction signalling module (cat. no SXMC02), a multifunction control module (cat. no SXM0C1), a measuring module, and so on. In this way on the Nemo SX display or in a supervision system the grouped function will be displayed as a unique “device” with all grouped functions. *[Refer to the scheme up here]*

7. COMPLIANCE AND APPROVALS

Compliance to standards:

- . Compliance with Directive on electromagnetic compatibility (EMC) n° 2014/30/EU
- . Compliance with low voltage directive n° 2014/35/EU.
- . Electromagnetic Compatibility:
 - IEC/EN 61131-2
 - IEC/EN 60947-5-1

Environment respect – Compliance with EU directives:

- . Compliance with Directive 2011/65/EU known as “RoHS 2” on the restriction of the use of certain hazardous substances in electrical and electronic equipment.
- . Compliance with REACH regulation: at the date of the publication of this document no substance from the candidate list is present in these products.

Plastic materials :

- . Halogens-free plastic materials.
- . Marking of parts according to ISO 11469 and ISO 1043.

Packaging :

- . Design and manufacture of packaging compliant to decree 98-638 of the 20/07/98 and also to directive 94/62/CE.

Environmental profile :

- . PEP document available