

Operating and Installation Instructions Display Unit

KERN KFE-TNM

Version 1.0
05/2016
GB

KFE-TNM-BA_IA-e-1610



KERN KFE-TNM

Version 1.0 05/2016

Operating and installation instructions Display unit

Contents

1	Technical data	4
2	Appliance overview	5
2.1	Keyboard overview	6
2.1.1	Numerical input via the navigation buttons	7
2.2	Overview of display.....	7
3	Basic Information (General)	8
3.1	Proper use	8
3.2	Improper Use.....	8
3.3	Warranty.....	8
3.4	Monitoring of Test Resources	9
4	Basic Safety Precautions	9
4.1	Pay attention to the instructions in the Operation Manual	9
4.2	Personnel training.....	9
5	Transport and storage	9
5.1	Testing upon acceptance.....	9
5.2	Packaging / return transport	9
6	Unpacking and installation	10
6.1	Installation Site, Location of Use.....	10
6.2	Unpacking and installation	10
6.3	Scope of delivery / serial accessories:	10
6.4	Transit Securing	11
6.5	Mains connection.....	11
6.6	Storage battery operation (optional).....	11
6.7	Adjustment.....	12
6.8	Linearization	15
6.9	Verification.....	16

7	Operation	18
7.1	Start-up.....	18
7.2	Switching Off	18
7.3	Zeroing	18
7.4	Simple weighing.....	18
7.5	Weighing with taring	19
7.6	Weighing with tolerance range	19
7.7	Manual totalizing.....	22
7.8	Automatic adding-up.....	24
7.9	Animal weighing.....	25
8	Menu	26
8.1	Navigation in the menu	26
8.2	Overview.....	26
9	Service, maintenance, disposal	28
9.1	Cleaning	28
9.2	Service, maintenance	28
9.3	Disposal.....	28
9.4	Error messages	29
10	Instant help.....	30
11	Installing display unit / weighing bridge.....	31
11.1	Technical data	31
11.2	Weighing system design.....	31
11.3	How to connect the platform	32
11.4	Configure display unit	33
12	Enclosure Declaration of conformity / Type approval / Test certificate. 37	

1 Technical data

KERN	KFE-TNM
Display	6-digit
Solution verifiable	6.000 e
Verification class	III
Weighing ranges	2
Divisions	1,2,5,...10, n
Display	LCD 22 mm digits with back lighting
DMS weighing cells	80-100 Ω . Max. 4 items per 350 Ω ; Sensitivity 2-3 mV/V
Electric Supply	Input voltage 220 V – 240 V, 50 Hz
	Mains adapter secondary voltage 12V, 500 mA
Rechargeable battery (optional)	6 x 1.5 V, 4 Ah
	Service life – background illumination OFF 35 h
	Loading time 12 h
Admissible ambient temperature	-10°C – 40°C
Net weight	1.9 kg
Protection type	IP 65 as per DIN EN 60529

Dimensions:

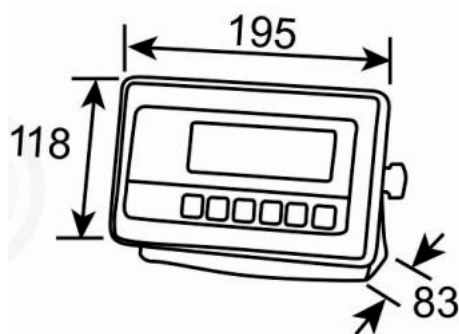

2 Appliance overview

Front view:

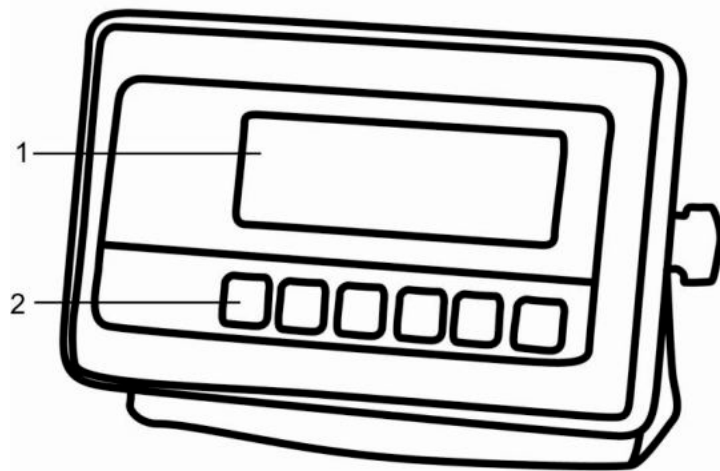

1. Weight display
2. Keyboard



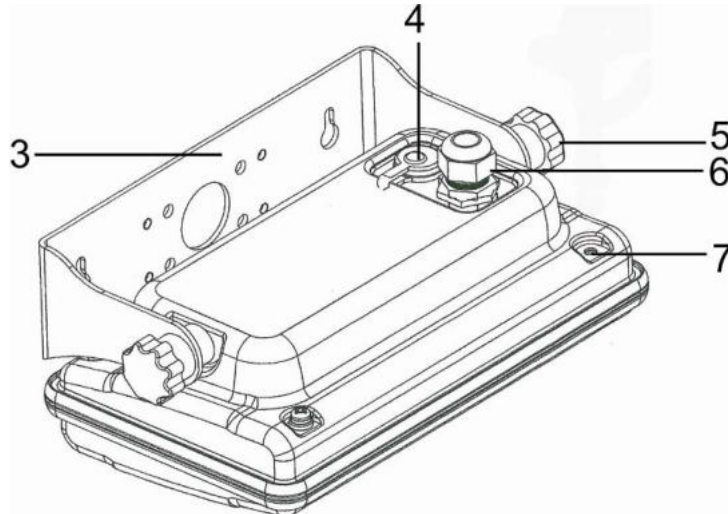



Rear view:

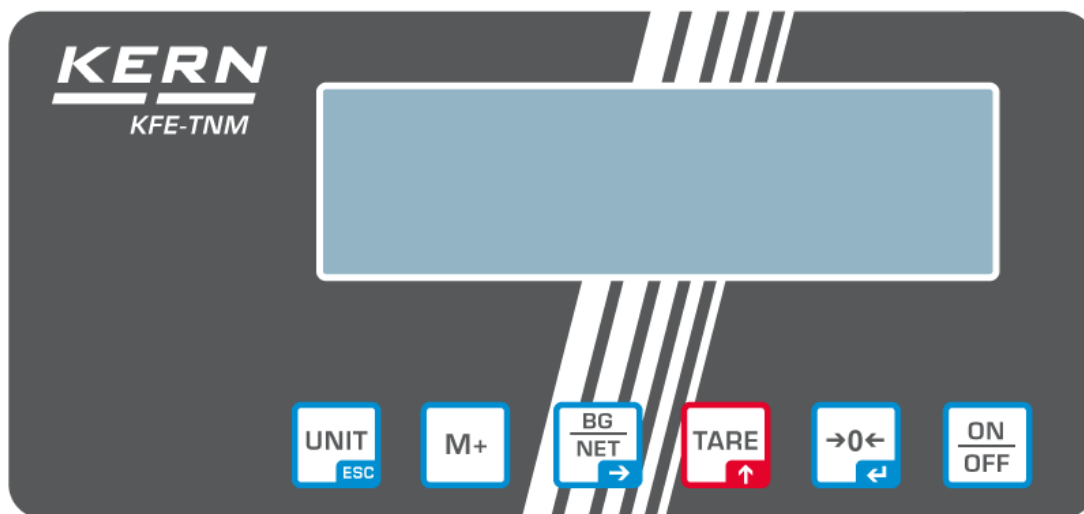





3. Wall bracket
4. Connection power supply (mains adapter)
5. Fastening screws
6. Connection platform
7. Position of seal / housing screw

2.1 Keyboard overview





Key	Function
	<ul style="list-style-type: none"> • Turn on/off
	<ul style="list-style-type: none"> • Zeroing
Navigation key ←	<ul style="list-style-type: none"> • Confirm entry
	<ul style="list-style-type: none"> • Taring
Navigation key ↑	<ul style="list-style-type: none"> • Scroll forward in menu • At numeric input increase flashing digit
	<ul style="list-style-type: none"> • Add weighing value to summation memory • Display sum total • Delete total added memory
	<ul style="list-style-type: none"> • Change between gross ↔ and net weight
Navigation key →	<ul style="list-style-type: none"> • Digit selection to the right
	<ul style="list-style-type: none"> • Switch-over weighing unit
ESC	<ul style="list-style-type: none"> • Back to menu/weighing mode

2.1.1 Numerical input via the navigation buttons

Key	Function
	Digit selection to the left
	Delete
	Digit selection to the right
	Increase flashing digit
	Terminate input

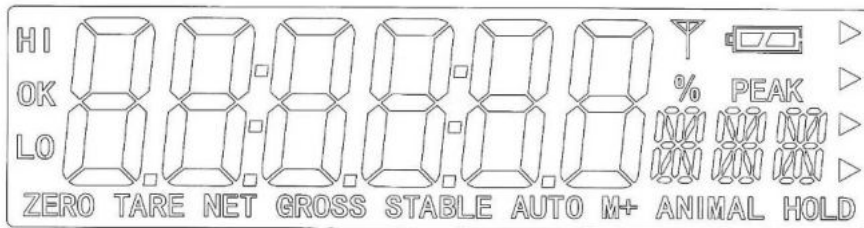
2.2 Overview of display



Display	Significance
HI OK LO	Status indicators for weighing with tolerance range HI: Weighed goods over default tolerance OK: Weighed goods within default tolerance LO: Load below specified tolerance
ZERO	Indicator zero display
TARE	Indicator for saved tare value
NET	The displayed weighing value is a net weighing value
GROSS	The displayed weighing value is a gross weighing value
STABLE	Stability display
AUTO	Function for „Automatic totalizing“ is activated
ANIMAL	Animal weighing mode is activated
	Charging status of rechargeable battery (optional)

3 Basic Information (General)

3.1 Proper use

The display unit acquired by you is used in combination with a weighing plate and serves to determine the weighing value of material to be weighed. It is intended to be used as a “non-automatic weighing system”, i.e. the material to be weighed is manually and carefully placed in the centre of the weighing plate. As soon as a stable weighing value is reached the weighing value can be read.

3.2 Improper Use

Do not use display unit for dynamic weighings. In the event that small quantities are removed or added to the material to be weighed, incorrect weighing results can be displayed due to the “stability compensation“ in the display unit. (Example: Slowly draining fluids from a container on the balance)

Do not leave permanent load on the weighing plate. This may damage the measuring system.

Impacts and overloading exceeding the stated maximum load (max) of the weighing plate, minus a possibly existing tare load, must be strictly avoided. Both, the weighing plate and the display unit may be damaged during this process.

Never operate display unit in explosive environment. The serial version is not explosion protected.

Changes to the display unit's design are not permitted. This may lead to incorrect weighing results, safety-related faults and destruction of the display unit.

The display unit may only be operated in accordance with the described default settings. Other areas of use must be released by KERN in writing.

3.3 Warranty

Warranty claims shall be voided in case

- Our conditions in the operation manual are ignored
- The appliance is used outside the described uses
- The appliance is modified or opened
- Mechanical damage or damage by media, liquids, natural wear and tear
- The appliance is improperly set up or incorrectly electrically connected
- The measuring system is overloaded

3.4 Monitoring of Test Resources

In the framework of quality assurance the measuring-related properties of the display unit and, if applicable, the testing weight, must be checked regularly. The responsible user must define a suitable interval as well as type and scope of this test. Information is available on KERN's home page (www.kern-sohn.com) with regard to the monitoring of display units' test substances and the test weights required for this. In KERN's accredited DKD calibration laboratory test weights and display units may be calibrated (return to the national standard) fast and at moderate cost.

4 Basic Safety Precautions

4.1 Pay attention to the instructions in the Operation Manual

Carefully read this operation manual before setup and commissioning, even if you are already familiar with KERN balances.

4.2 Personnel training

The appliance may only be operated and maintained by trained personnel.

5 Transport and storage

5.1 Testing upon acceptance

When receiving the appliance, please check packaging immediately, and the appliance itself when unpacking for possible visible damage.

5.2 Packaging / return transport



- ⇒ Keep all parts of the original packaging for a possibly required return.
- ⇒ Only use original packaging for returning.
- ⇒ Prior to dispatch disconnect all cables and remove loose/mobile parts.
- ⇒ Reattach possibly supplied transport securing devices.
- ⇒ Secure all parts such as the glass wind screen, the weighing platform, power unit etc. against shifting and damage.

6 Unpacking and installation

6.1 Installation Site, Location of Use

The display units are designed in a way that reliable weighing results are achieved in common conditions of use. Precise and fast work is achieved by selecting the right place for your display unit and your weighing plate.

On the installation site observe the following:

- Place the display unit and the weighing plate on a stable, even surface.
- Avoid extreme heat as well as temperature fluctuation caused by installing next to a radiator or in the direct sunlight;
- Protect the display unit and the weighing plate against direct draft from open windows or doors.
- Avoid jarring during weighing;
- Protect the display unit and the weighing plate against high humidity, vapours and dust.
- Do not expose the display unit to extreme dampness for longer periods of time. Non-permitted condensation (condensation of air humidity on the appliance) may occur if a cold appliance is taken to a considerably warmer environment. In this case, acclimatize the disconnected appliance for ca. 2 hours at room temperature.
- Avoid static charge of goods to be weighed or weighing container.

Major display deviations (incorrect weighing results) may be experienced should electromagnetic fields (e.g. due to mobile phones or radio equipment), static electricity accumulations or instable power supply occur. Change location or remove source of interference.

6.2 Unpacking and installation

Take the display unit carefully out of its packaging, remove the plastic jacket and install it at the designated work space. Mount the display unit in a way that facilitates operation and where it is easy to see.

6.3 Scope of delivery / serial accessories:

- For display unit, see chapter 2
- Mains adapter
- Operating instructions

6.4 Transit Securing

Please note, if the display unit is used together with platform with transportation lock, this transportation lock must be released prior to use.

See operating instructions attached to the respective platform.

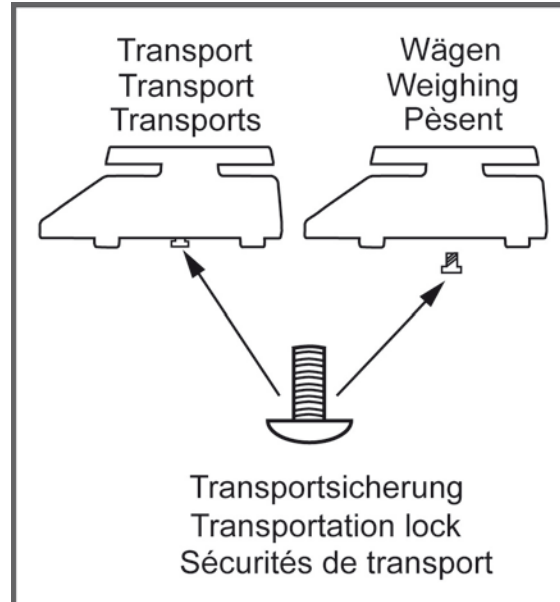

6.5 Mains connection

Power is supplied via the external mains adapter. The stated voltage value must be the same as the local voltage.



Only use original KERN mains adapters. Using other makes requires consent by KERN.

6.6 Storage battery operation (optional)

Before the first use, the battery should be charged by connecting it to the mains power supply for at least 12 hours.

The appearance of the rechargeable battery symbol in the weight display indicates that the battery is almost exhausted. The unit will be ready for operation for approx. another 10 hours before switching off automatically. Charge the battery with the help of the supplied power pack.

The rechargeable battery symbol shows the charge status of the rechargeable battery:

-  Voltage has dropped below prescribed minimum.
-  Battery very low.
-  Battery is completely discharged

6.7 Adjustment

As the acceleration value due to gravity is not the same at every location on earth, each display unit with connected weighing plate must be coordinated - in compliance with the underlying physical weighing principle - to the existing acceleration due to gravity at its place of location (only if the weighing system has not already been adjusted to the location in the factory). This adjustment process must be carried out for the first commissioning, after each change of location as well as in case of fluctuating environment temperature. To receive accurate measuring values it is also recommended to adjust the display unit periodically in weighing operation.



- The adjustment is locked for verified balances.













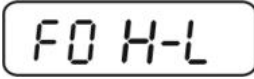









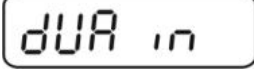

In order to unlock the access, the seal must be destroyed and the jumper on the printed circuit board must be fitted (see chap. 6.9).

Attention:

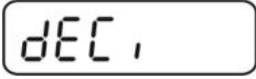





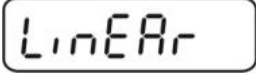





After destruction of the seal the weighing system must be re-verified by an authorised agency and a new verification wire/seal mark fitted before it can be reused for applications subject to verification.

- The weight to be used depends on the capacity of the scale. Carry out adjustment as near as possible to the scale's maximum weight. Info about test weights can be found on the Internet at: <http://www.kern-sohn.com>.
- Observe stable environmental conditions. Stabilisation requires a certain warm-up time.

Call-up menu

<p>⇒ In weighing mode press  and  at the same time and the first menu block <i>F0 H-L</i> will appear.</p>	
<p>⇒ Press  repeatedly until <i>PrOG</i> is displayed.</p>	
<p>⇒ Press , password query <i>P1n</i> will appear.</p>	
<p>⇒ Press , ,  subsequently until the first menu item <i>PI SPED</i> is shown.</p>	
<p>⇒ Press  repeatedly until <i>P2 nod</i> is displayed.</p>	
<p>⇒ Confirm by .</p> <p>⇒ Press  repeatedly until the currently balance typ will be displayed.</p> <p><i>SiGr</i> = Singel range <i>dUA rA</i> = Dual range <i>dUA in</i> = Multi interval</p>	 ⇕  ⇕ 
<p>⇒ Confirm by .</p>	
<p>⇒ Press  repeatedly until <i>CAL</i> will be displayed.</p>	
<p>⇒ Confirm by  and select by .</p> <p><i>nonLin</i> = Justierung <i>LinERr</i> = Linearisierung</p>	 ⇕ 

Procedure

<p>⇒ Confirm menu setting <i>nonLin</i> by  . Ensure that there are no objects on the weighing plate.</p> <p>⇒ Wait for stability display, then press .</p>	 ↓ 
<p>⇒ The currently set adjustment weight will be displayed.</p>	
<p>⇒ Either use the displayed adjustment weight or change it with ,  and  (numerical input see chapter 2.1.1), the active digit is flashing.</p> <p>⇒ Confirm by , „LoAd“ will be shown.</p>	
<p>⇒ Carefully place adjusting weight in the centre of the weighing plate. Wait for stability display, then press .</p>	
<p>⇒ After the adjustment the balance will carry out a self-test. Remove adjusting weight during selftest, balance will return into weighing mode automatically. An adjusting error or incorrect adjusting weight will be indicated by the error message; repeat adjustment procedure.</p>	

6.8 Linearization

Linearity shows the greatest deviation of a weight display on the scale to the value of the respective test weight according to plus and minus over the entire weighing range.

If linearity deviation is discovered during a testing instrument control, you can improve this by means of linearization.

i

- Carrying out linearization is restricted to specialist staff possessing well acquainted with the workings of weighing scales.
- The linearisation is locked for verified weighing systems.

In order to unlock the access, the seal must be destroyed and the jumper on the printed circuit board must be fitted (see chap. 6.9).

Attention:

After destruction of the seal the weighing system must be re-verified by an authorised agency and a new verification wire/seal mark fitted before it can be reused for applications subject to verification.

- The test weights to be used must be adapted to the weighing scale's specifications; see chapter 3.4 "testing instruments control".
- Observe stable environmental conditions. Stabilisation requires a certain warm-up time.
- After successful linearization you will have to carry out calibration; see chapter "testing instruments control"

Procedure:

⇒ Call-up menu setting *LinEAR*, see chap. 6.7.

LinEAR



⇒ Acknowledge with . Ensure that there are no objects on the weighing plate.

LoAd 0
STABLE

⇒ Wait for stability display „STABLE“, then press . When „LoAd 1“ is displayed, put the first adjustment weight (1/3 max) carefully in the centre of the weighing platform.

LoAd 1
STABLE

⇒ Wait for stability display „STABLE“, then press . When „LoAd 2“ is displayed, put the second adjustment weight (2/3 max) carefully in the centre of the weighing platform.

LoAd 2
STABLE

⇒ Wait for stability display „STABLE“, then press . When “LoAd 3” is displayed, put the third adjustment weight (1/3 max) carefully in the centre of the weighing platform.



⇒ Wait for stability display „STABLE“, then press .



⇒ After the adjustment the balance will carry out a self-test. Remove adjusting weight **during** selftest, the appliance will return into weighing mode automatically.



An adjusting error or incorrect adjusting weight will be indicated by the error message; repeat adjustment procedure.

6.9 Verification

General introduction:

According to EU directive 90/384/EEC or 2009/23EG balances must be officially verified if they are used as follows (legally controlled area):

- For commercial transactions if the price of goods is determined by weighing.
- For the production of medicines in pharmacies as well as for analyses in the medical and pharmaceutical laboratory.
- For official purposes
- For manufacturing final packages

In cases of doubt, please contact your local trade in standard.

Verification notes:

An EU type approval exists for balances described in their technical data as verifiable. If a balance is used where obligation to verify exists as described above, it must be verified and re-verified in regular intervals.

Re-verification of a balance is carried out according to the respective national regulations. The validity for verification of balances in Germany is e.g. 2 years.

The legal regulation of the country where the balance is used must be observed!



Verification of the balance is invalid without the seal.

The seal marks attached on verified balances point out that the balance may only be opened and serviced by trained and authorised specialist staff. If the seal mark is destroyed, verification loses its validity. Please observe all national laws and legal regulations. In Germany a re-verification will be necessary.

Position of seals and jumper

Access to conductor plate:

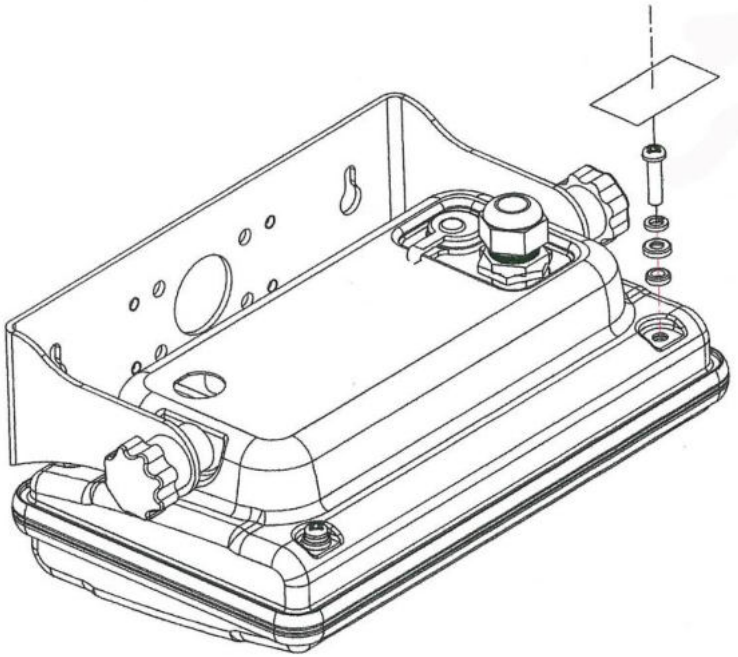

- ⇒ Remove seal
- ⇒ Open display unit



- ⇒ For adjustment / access to the configuration menu the jumper „CAL“ must be fitted.

7 Operation

7.1 Start-up

- ⇒ Press  and the instrument will carry out a self-test. As soon as the weight display appears, the instrument will be ready to weigh.



7.2 Switching Off

- ⇒ Press  and the display will disappear.

7.3 Zeroing

Resetting to zero corrects the influence of light soiling on the weighing plate.

- ⇒ To unload the weighing system

- ⇒ Press  and zero display as well as indicator ZERO will appear.



7.4 Simple weighing

- ⇒ Place goods to be weighed on balance.
⇒ Wait until stability display **STABLE** appears.
⇒ Read weighing result.



Overload warning

Overloading exceeding the stated maximum load (max) of the device, minus a possibly existing tare load, must be strictly avoided. This could damage the instrument.

Exceeding maximum load is indicated by the display of "ol", and an audio sound. Unload weighing system or reduce preload.

7.5 Weighing with taring

- ⇒ Deposit weighing vessel. After successful stop check press the  button. Zero display and indicator NET appear.



The weight of the container is now internally saved.

- ⇒ Weigh the material, the net weight will be indicated.
- ⇒ After removing the weighing container, the weight of the weighing container appears as negative display.
- ⇒ The taring process can be repeated any number of times, e.g. when adding several components for a mixture (adding). The limit is reached when the whole weighing range is exhausted.

- ⇒ To change between gross weight and net weight, press .

- ⇒ To delete the tare value, remove load from weighing plate and press .

7.6 Weighing with tolerance range

You can set an upper or lower limit when weighing with tolerance range and thus ensure that the weighed load remains exactly within the set limits.

During tolerance controls such as dispensing, portioning or sorting the unit will indicate whether a value exceeds or falls short of limits with an optical [LO, OK, HI] as well as an audio signal according to the setting in the menu block "F4 oFF_BEEP"; see chapter 8.2.

Selectable mode	Description
bp 1	Acoustic signal switched off, only optical signal active [LO], [OK] or [HI]
bp 2	If load is within tolerance range, [ok] will be displayed and audio signal will be sounded.
bp 3	If the load is beyond the tolerance range [ok] will be shown and the audio signal will sound.

1. Call up menu

- ⇒ In weighing mode press  and  at the same time and the first menu block *FO H-L* will appear.

0.000 kg
ZERO GROSS STABLE



FO H-L

2. Set limit values

- ⇒ Keep on pressing  until the display used for entering the lower limit **SET LO** appears.

SEt Lo

- ⇒ Press  and current setting will be displayed.

000.000

- ⇒ To enter the lower limit, e. g. 1000 Kg, press the navigation keys (See chpt. 2.1.1); the currently enabled digit will be flashing.

00 1.000

- ⇒ Confirm input by .

SEt Lo

- ⇒ Select **SET HI** by pressing .

SEt Hi

- ⇒ Press  and the current setting for the upper limit will be displayed.

000.000

- ⇒ Press the navigation keys (See chpt. 2.1.1) to enter the upper limit, e.g. 1,100 kg; the currently enabled digit will be flashing.

00 1.100

- ⇒ Confirm input by .

SEt Hi

- ⇒ Press  and the unit will return to the menu

FO H-L

3. How to set tolerance weighing mode

⇒ Press  repeatedly until *F4 OFF* is displayed.

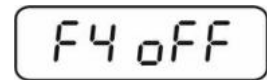

⇒ Acknowledge with .



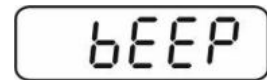

⇒ Press  repeatedly until *BEEP* is displayed.



⇒ Press  and current setting will be displayed.



⇒ Select desired setting (bp 1, bp 2, bp 3) with  and confirm by pressing .

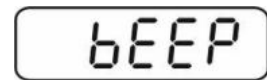



⇒ Press  repeatedly to exit menu. The weighing system is in tolerance weighing mode, i.e. from here occurs the graduation if the weighed material is within the two tolerance limits.



4. Weighing with tolerance range

⇒ Tare when using a weighing container

⇒ Put on goods to be weighed, tolerance control is started

Load below specified tolerance	Load within specified tolerance	Load exceeds specified tolerance
		
The indicator [LO] is displayed	The indicator [OK] is displayed	The indicator [HI] is displayed



- The tolerance control is not active when the weight is under 20d.
- To delete limits, enter "00.000 kg".

7.7 Manual totalizing

With this function the individual weighing values are totalized into the sum memory by pressing .



- Menu settings:
 - „F5 Prt“ ⇒ „P prt“, see chap. 8.2
 - “P4 CHk“ ⇒ „mode 1“, see chap. 11.4
- The totalizing function is not active when the weight is under 20d.

Add up:

⇒ Place weighing goods A.

Wait until the stability display **STABLE** appears, then press . The weighing value is saved.

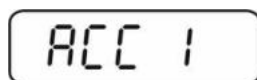

⇒ Remove the weighed good. More weighed goods can only be added when the display \leq zero.



⇒ Place goods to be weighed B.

Wait until the stability display appears, then press . The weighing value is added into the summation memory. Number of weighing, followed by the total weight will be displayed for 2 sec.



⇒ Add more weighed goods as described before.



Please note that the weighing system must be unloaded between the individual weighing procedures.

⇒ You can repeat this process 99 times until the capacity (max) of the weighing system is exhausted.

Display of the saved weighing data:

⇒ When zero is displayed press , the number of weighings followed by the total weight will be displayed for 2 sec.

Delete weighing data:

⇒ If you see a display of zero, press  and the number of weighing, followed by the total weight will be shown for 2 sec. Press  during this display. The data in the summation memory are deleted.



7.8 Automatic adding-up

This function is used to issue and add individual weighing values automatically to the summation memory on unloading of weighing scale without pressing .

- i** • Menu settings:
 - „F5 Prt“ ⇒ „P prt“, see chap. 8.2
 - “P4 CHk“ ⇒ „mode 1“, see chap. 11.4
- When function is activated, the indicator **AUTO** appears.



Add up:

- ⇒ Place weighing goods A.
After the standstill control sounds a signal tone.
- ⇒ Unload the weighing good, the weighing value is added into the summation memory.

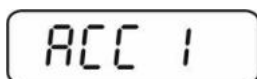

More weighed goods can only be added when the display \leq zero.



- ⇒ Place goods to be weighed B.
After the standstill control sounds a signal tone. Unload the weighing good, the weighing value is added into the summation memory. Number of weighing, followed by the total weight will be displayed for 2 sec.

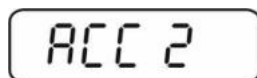

- ⇒ Add more weighed goods as described before.
Please note that the weighing system must be unloaded between the individual weighing procedures.
- ⇒ You can repeat this process 99 times until the capacity (max) of the weighing system is exhausted.

- i** • After the audio sound was sounded you can remove the load or add to it.
- Display and delete weighing data see chap. 7.7.

7.9 Animal weighing

The mean value function is suitable for weighing restless loads.

i Menu setting:

P4 CHT ⇒ *mode 2*, see chap. 11.4

When function is activated, the indicator **ANIMAL** appears.









- ⇒ Place goods to be weighed on balance.
- ⇒ When the load has somewhat calmed down, you will hear an audio sound. The mean value achieved will be shown.
- ⇒ Whilst averaging is taking place you can add or remove loads as the measuring value will be constantly updated.

To disable the animal weighing function, return to weighing mode



Select menu setting *P4 CHT* ⇒ *mode 1*, see chpt. 11.4.

8 Menu

8.1 Navigation in the menu

Call up menu	⇒ In weighing mode press  and  at the same time and the first menu block <i>F0 H-L</i> will appear.
Select menu block	⇒ With help of  , the individual menu blocks can be selected one after the other.
Select setting	⇒ Confirm selected menu item by pressing  . The current setting will be displayed.
Change settings	⇒ To change to the available settings, press the navigations keys as described in chpt. 2.1.1.
Acknowledge setting / exit the menu	⇒ Either save by pressing  or cancel by pressing  .
Return to weighing mode	⇒ Press  repeatedly to exit menu.

8.2 Overview

Menu block	Menu item	Available settings / explanation
<i>F0 H-L</i> Weighing with tolerance range	SET Lo	Upper limit value, input see chapter 7.6 (factory setting 000.000)
	SET Hi	Lower limit value, input see chapter 7.6 (factory setting 000.000)
<i>F1 tol</i>	to Clr	Not documented
	to P-C	Not documented
	to Prt	Not documented
<i>F2 Unt</i> Weighing Units		Factory setting „kg“, no further units available.
<i>F3 t,</i> Date/time	SET dA	Set date Press  and the currently set date (yy.mm.dd) will be displayed. To make changes, press the navigation keys as explained in chpt. 2.1.1.
	SET ti	Set time Press  and the currently set time (hh.m.ss) will be displayed. To make changes, press the navigation keys as explained in chpt. 2.1.1.

F4 OFF	Clock	Clk on	Display time switched on After 5 min without change of load the weight display passes to the time display.
		Clk of*	Display of time OFF
	bl	bk on	Background lighting of display is switched on permanently
		bk AU	Display background illumination off
		bk off	Automatic background illumination on when weighing pate is loaded or key pressed.
	bBEEP see chpt 7.6	bp 1	Audio signal switched off during tolerance weighing
		bp 2	If load is within tolerance, [ok] will be displayed and audio signal will be sounded
		bp 3	If the load is beyond the tolerance range, [ok] will be shown and the audio signal will sound.
	F5 Prt	P Prt	Manual totalizing, see chap. 7.7
P Cont		Not documented	
Series		Not documented	
ASK		Not documented	
P cnt 2		Not documented	
P Stab		A Not documented	
P Auto		For automatic totalizing see chpt. 7.8.	
Confirm selection by  , after that the following menu items are available.			
	b9600 Pr X Lab X Ty-tp Ty 711 Lp 50	Not documented	
F6 St	St on	Following tare ON	
	St off	Following tare OFF	
PrOG	PIn	Access to configuration menu see chap. 11.4	

9 Service, maintenance, disposal



Before any maintenance, cleaning and repair work disconnect the appliance from the operating voltage.

9.1 Cleaning

- ⇒ Keep IP protection.
- ⇒ Clean the stainless-steel parts with a soft cloth soaked with a cleaning agent suitable for stainless steel.
- ⇒ For stainless steel parts do not use any cleaning agents which contain sodium hydroxide solution, acetic, hydrochloric, sulphuric or citric acid.
- ⇒ Do not use metal brushes or cleaning sponges of steel wool, as this causes superficial corrosion.

9.2 Service, maintenance

- ⇒ The appliance may only be opened by trained service technicians who are authorized by KERN.
- ⇒ Ensure that the balance is regularly calibrated, see chap. Testing instruments control.

9.3 Disposal

- ⇒ Disposal of packaging and appliance must be carried out by operator according to valid national or regional law of the location where the appliance is used.

9.4 Error messages

Error message	Description	Possible causes
- - - - -	Maximum load exceeded	<ul style="list-style-type: none"> • Unload weighing system or reduce preload.
- - ol - -		
Err 1	Incorrect data input	<ul style="list-style-type: none"> • Follow format “yy:mm:dd“
Err 2	Incorrect time entry	<ul style="list-style-type: none"> • Follow format “hh:mm:ss“
Err 4	Zeroing range exceeded due to switching-on balance or pressing  (normally 4% max)	<ul style="list-style-type: none"> • Object on the weighing plate • Overload when zeroing
Err 5	Keyboard error	
Err 6	Value outside the A/D changer range	<ul style="list-style-type: none"> • Weighing plate not installed • Damaged weighing cell • Damaged electronics
Err 9	Stability display does not appear	<ul style="list-style-type: none"> • Check the environmental conditions.
Err 17	Taring range exceeded	<ul style="list-style-type: none"> • Reduce load
Fai l h / Fai l l	Adjustment error	<ul style="list-style-type: none"> • Repeat adjustment.
Ba lo / Lo ba	Battery very low	<ul style="list-style-type: none"> • Recharge battery

Should other error messages occur, switch balance off and then on again. If the error message remains inform manufacturer.

10 Instant help

In case of an error in the program process, briefly turn off the display unit and disconnect from power supply. The weighing process must then be restarted from the beginning.

Help:

Fault

Possible cause

The displayed weight does not glow.

- The display unit is not switched on.
- Mains power supply interrupted (mains cable defective).
- Power supply interrupted.
- (Rechargeable) batteries are inserted incorrectly or empty
- No (rechargeable) batteries inserted.

The displayed weight is permanently changing

- Draught/air movement
- Table/floor vibrations
- Weighing plate has contact with other objects.
- Electromagnetic fields / static charging (choose different location/switch off interfering device if possible)

The weighing result is obviously incorrect

- The display of the balance is not at zero
- Adjustment is no longer correct.
- Great fluctuations in temperature.
- Warm-up time was ignored.
- Electromagnetic fields / static charging (choose different location/switch off interfering device if possible)

11 Installing display unit / weighing bridge



Installation / configuration of the weighing system must be carried out by a well acquainted specialist with the workings of weighing balances.

11.1 Technical data

Supply voltage:	5 V/150mA
Max. signal voltage	0 ~ 15 mV
Zeroing range	0 ~ 5 mV
Sensitivity	2-3 mV/V
Resistance parameter	80 - 100 Ω , max 4 items per 350 Ω load cell

11.2 Weighing system design

The display unit is suitable for connection to any analogue platform in compliance with the required specifications.

The following data must be established before selecting a weighing cell:

- **Weighing balance capacity**
This usually corresponds to the heaviest load to be weighed.
- **Preload**
This corresponds to the total weight of all parts that are to be placed on the weighing cell such as upper part of platform, weighing pan etc.
- **Total zero setting range**
This is composed of the start-up zero setting range ($\pm 2\%$) and the zero setting range available to the user via the ZERO-key (2%). The total zero setting range equals therefore 4 % of the scale's capacity.

The addition of weighing scales capacity, preload and the total zero setting range give the required capacity for the weighing cell.

To avoid overloading of the weighing cell, include an additional safety margin.

- **Smallest desired display division**

11.3 How to connect the platform







- ⇒ Disconnect device from mains.
- ⇒ Pull load cell cable into the display unit through the screwable cable attachment.
- ⇒ Weld the individual wires of the load cell cable to the printed circuit board, see fig. 1. Details can be seen in the technical data of the load cell.









Fig. 1

11.4 Configure display unit

Call-up configuration menu:

- ⇒ In weighing mode press  and  at the same time and the first menu block *FO H-L* will appear.
- ⇒ Press  repeatedly until *PrOÜ* is displayed.
- ⇒ Press , password query *Pi n* will appear.
- ⇒ Press , ,  subsequently until the first menu item *PI SPED* is shown.

Navigation in the menu

- ⇒ With help of , the individual menu items can be selected one after the other.
 - ⇒ Confirm selected menu item by pressing . The current setting will be displayed.
 - ⇒ Switch into the available settings using .
 - ⇒ Either save by pressing  or cancel by pressing .
- Press  repeatedly to exit menu.

Configuration menu overview:

Menu block Main menu	Menu item Submenu	Available settings / explanation	
P1 SPED	SPd 15	Not documented	
	SPd 30		
	SPd 60		
	SPd 7.5		
P2 mod	SIG rA	Single-range balance Confirm by  , after that the following menu items are available.	
		dEE ,	Position decimal point available selection 0, 0.0, 0.00, 0.000, 0.0000
		inC	Readability/verification value selectable 1, 2, 5, 10, 20, 50
		inC 1	
		inC 2	
		inC 5	
		inC 10	
		inC 20	
		inC 50	
		CAP	Balance capacity (max)
Adjust weighing system according to configuration.			
CAL	nonLin	Adjustment, see chap. 6.7	
	LinEAR	For linearisation see chapter 6.8	

	dual range	Dual range balance			
		Confirm by  , after that the following menu items are available.			
		dEC	Position decimal point available selection 0, 0.0, 0.00, 0.000, 0.0000		
		inC	diU 1	inC 1	Readability / verification value for 1. Weighing range Selectable 1, 2, 5, 10, 20, 50
				inC 2	
				inC 5	
				inC 10	
				inC 20	
				inC 50	
			diU 2	inC 1	Readability / verification value for 2. Weighing range Selectable 1, 2, 5, 10, 20, 50
				inC 2	
				inC 5	
inC 10					
inC 20					
inC 50					
	CAP	CAP 1	Balance capacity (Max) 1st weighing range		
		CAP 2	Balance capacity (Max) 2nd weighing range		
	Adjust weighing system according to configuration.				
	CAL	nonLin	Adjustment, see chap. 6.7		
		LinERr	For linearisation see chap. 6.8		

	dUR in		Multi-interval balance Confirm by  , after that the following menu items are available.	
	dEC ,		Position decimal point available selection 0, 0.0, 0.00, 0.000, 0.0000	
	inC	diU 1	inC 1	Readability / verification value for 1. Weighing range Selectable 1, 2, 5, 10, 20, 50
			inC 2	
			inC 5	
			inC 10	
			inC 20	
		diU 2	inC 1	Readability / verification value for 2. Weighing range Selectable 1, 2, 5, 10, 20, 50
			inC 2	
			inC 5	
inC 10				
inC 20				
CAP	CAP 1	Balance capacity (Max) 1st weighing range		
	CAP 2	Balance capacity (Max) 2nd weighing range		
Adjust weighing system according to configuration.				
CAL	nonLin	Adjustment, see chap. 6.7		
	LinErr	For linearisation see chapter 6.8		
P3 Pro	tri		Not documented	
	CoUnt		Internal A/D converter value	
	rESEt		Reset to default setting	
	GrA		Not documented	
P4 CHT	mode 1		Weighing mode (tolerance weighing, totalizing)	
	mode 2		Animal weighing mode	
	mode 3		Not documented	
	mode 4		Not documented	

