

Operating and Installation Instructions Display Unit

KERN KXS/KXG-TM

Version 2.2
2017-12
GB



KXS/KXG-TM-BA_IA-e-1722



KERN KXS/KXG-TM

Version 2.2 2017-12

Operating and installation instructions Display unit

Contents

1	Technical data	5
2	Appliance overview	6
2.1	Keyboard overview	7
2.1.1	Models KXS-TM:	7
2.1.2	Models KXG-TM:	8
2.2	Overview of display	10
3	Basic Information (General)	12
3.1	Proper use	12
3.2	Improper Use	12
3.3	Warranty	12
3.4	Monitoring of Test Resources	13
4	Basic Safety Precautions	13
4.1	Pay attention to the instructions in the Operation Manual	13
4.2	Personnel training	13
5	Transport and storage	13
5.1	Testing upon acceptance	13
5.2	Packaging / return transport	13
6	Unpacking and placing	14
6.1	Installation Site, Location of Use	14
6.2	Unpacking and placing	14
6.3	Scope of delivery / serial accessories:	14
6.4	Transport Securing	15
6.5	Placing	15
6.6	Mains connection	15
6.7	Rechargeable battery operation (Factory option)	15
6.8	Adjustment	16
6.9	Verification	16
7	Basic Operation	18
7.1	Start-up	18
7.2	Switching Off	18
7.3	Zeroing	18
7.4	Simple weighing	18
7.5	Switch-over weighing unit	19
7.6	Weighing with tare	19
7.6.1	Taring	19
7.6.2	Delete tare	19
7.6.3	Numerical input of tare (PRE-TARE)	20
7.7	Gross/Net call-up	20

8	Applications:	21
8.1	Parts counting.....	21
8.2	Totalization.....	23
9	Menu	27
10	Indicator settings (menu block "01 FnC")	28
10.1	Backlighting of the display (function "FnC 01").....	31
10.2	Automatic power cut "Auto power off (function „FnC 02“)".....	32
10.3	Weighing with tolerance range (function "FnC 03 „)".....	33
10.4	Resetting to factory settings (function "FnC 04 „)".....	37
10.5	Automatic zero-adjusting/ stability and response settings (function "FnC 05“)".....	38
10.6	Data Hold functions (function "FnC 06“)".....	40
10.6.1	Animal weighing function.....	41
10.7	Automatic reference optimisation with the unit count (function „FnC 07“)".....	46
10.8	Automatic storage of zero point (function "FnC 10“)".....	47
10.9	Function of the F-key (function „FnC 12“)".....	48
10.10	Auto Zero.....	49
11	External adjustment "Unverified weighing systems „ (menu block "02 EC")	50
12	Settings RS 232 (menu block "03 rS1")	53
12.1	Baud rate (function "rS1 01“)"	56
12.2	Parity (function "rS1 02“)".....	57
12.3	Output format (function "rS1 03“)".....	58
12.4	Output format (function „rS1 04“)"	60
12.5	Continuous output rate (function „rS1 05“)"	61
12.6	Automatic data output with zero display (function "rS1 06“)"	62
12.7	Condition for data output (function "rS1 08")	63
12.8	6/ 7-digit data format (function "rS1 09")	64
12.9	Set the date/ time (function "rS1 10“)"	65
13	Instruction mode	68
14	Data output format	70
14.1	7-digit data format (first decimal place not included)	70
14.2	6-digit data format (first decimal place not included)	70
15	Bluetooth (Factory option)	71
16	Servicing, maintenance, disposal	75
16.1	Clean	75
16.2	Servicing, maintenance.....	75
16.3	Disposal.....	75
16.4	Error messages	75
17	Instant help	76
18	Installation display appliance/ load cell	77
18.1	Weighing system design	77
18.2	Attach the load cell	78
18.3	Attach RS232	79

19	Service menu	80
19.1	Configure weighing system / menu block 01 CSP	82
19.1.1	Unverified weighing systems (function „CSP 01“)	83
19.1.2	Verified balancing systems (function "CSP 02“)	87
19.1.3	Set the buffeting point (function „CSP 03“)	91
19.2	Linearization/ menu block 03 CLn	93
19.3	Adjustment of "verified weighing systems / menu block 02 CAL "	97
19.4	Amend the local gravitation zone/ menu block 06 CGr	100
19.5	Appliance settings/ menu block 04 CFn	101
19.5.1	Parameter „adjustment to site conditions“ (function „CFn 01“)	102
19.5.2	Configuration „verified/ unverified“ (function „CFn 02“)	105
19.5.3	Resetting to zero when switched on (function "CFn 04“)	106
19.5.4	Amend the DATA Hold function of verified weighing system (function „CFn 05“)	107
19.5.5	Auto zero (verified weighing systems)/ function "CFn 06"	109
19.5.6	Parts counting on / off „CFn 07“	110
20	Declaration of Conformity	111

1 Technical data

KERN	KXS-TM	KXG-TM
Display	6-digit	
Solution verifiable	Single (Max.) 10,000 e	
	Dual (Max.) 5,000 e	
Resolution non-verifiable	30,000 d	
Verification class	III	
Weighing ranges	Max. 2	
Weighing Units	g, kg	
Divisions	1,2,5,...10, n	
Display	LCD 55 mm digits with back lighting	
DMS weighing cells	Max. 8 x 350 Ω	
Electric Supply	Input voltage 110-230 V AC	
	Built-in power supply unit	
Rechargeable battery optional Factory option	6 V, 4.5 Ah	
	Operating time (backlight on) 40 h Operating time (backlight off) 80 h	
	Loading time 12 h	
Admissible ambient temperature	-10°C – 40°C	
Humidity of air	< 85 % relative (not condensing)	
Net weight	2500 g	2000 g
Dimensions Width x Depth x Height, (mm)	232 x 170 x 80	
Interfaces Factory option	RS232: KXS-A04	
	RS485: KXS-A01	
	Bluetooth: KXS-A02	
Protection type	IP 68 according to DIN 60529	

2 Appliance overview

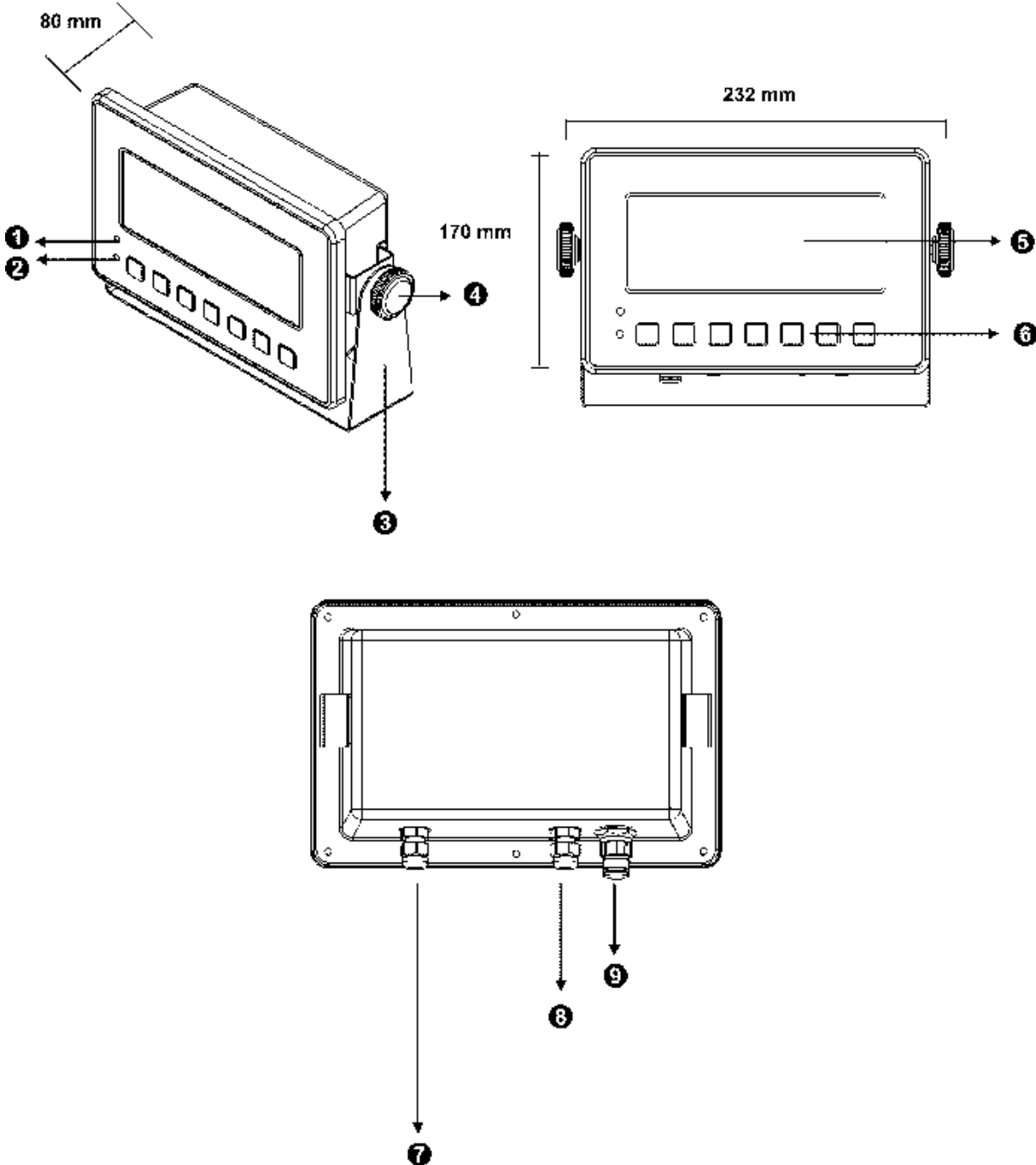





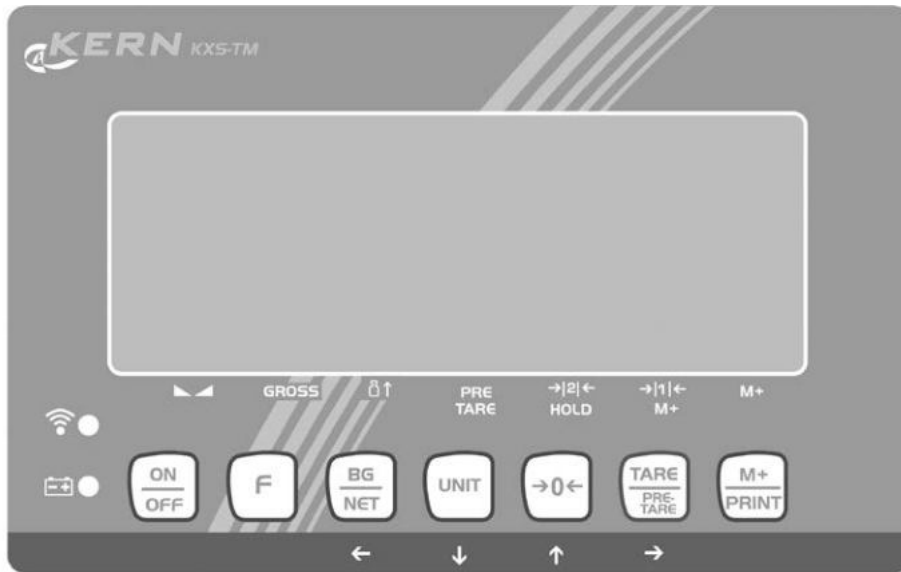

1	Wireless
2	Status of rechargeable battery
3	Wall bracket
4	Locking screw
5	Display
6	Keyboard
7	Electric Supply
8	RS 232 / RS485 (Factory option)
9	Connection to the load cell





2.1 Keyboard overview

2.1.1 Models KXS-TM:





Button	Description	Function
	ON/OFF button	1. Turn on/off
	F-key	<ul style="list-style-type: none"> Functional button (allocation see chap. 10.1 FNC-03)
	BG/ NET key	<ul style="list-style-type: none"> Gross weight ↔ switch over to net weight
	UNIT-key	<ul style="list-style-type: none"> Weighing unit
	TARE button	<ul style="list-style-type: none"> Taring Confirm entry
	ZERO key	<ul style="list-style-type: none"> Zeroing
	M+/ PRINT key	<ul style="list-style-type: none"> Functional button (allocation see chap. 10.1 FNC-02)





2.1.1.1 Navigation keys and their function in the menu

	↑	<ul style="list-style-type: none"> • Increase flashing digit • Scroll forward in menu
	↓	<ul style="list-style-type: none"> • Decrease flashing digit • Scroll backwards in menu
	→	<ul style="list-style-type: none"> • Digit selection to the right • Take over selected setting
	←	Digit selection to the left





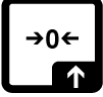



2.1.2 Models KXG-TM:

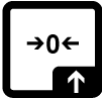

Button	Description	Function
	ON/OFF button	<ul style="list-style-type: none"> • Turn on/off
	F-key	<ul style="list-style-type: none"> • Functional button (allocation see chap. 10.1 FNC-03)

	BG/ NET key	<ul style="list-style-type: none"> Gross weight ⇔ switch over to net weight
	UNIT-key	<ul style="list-style-type: none"> Weighing unit
	TARE button	<ul style="list-style-type: none"> Taring Confirm entry
	ZERO key	<ul style="list-style-type: none"> Zeroing
	M+/ PRINT key	<ul style="list-style-type: none"> Functional button (allocation see chap. 10.1 FNC-02)

2.1.2.1 Navigation keys and their function in the menu

		<ul style="list-style-type: none"> Increase flashing digit Scroll forward in menu
		<ul style="list-style-type: none"> Decrease flashing digit Scroll backwards in menu
		<ul style="list-style-type: none"> Digit selection to the right Take over selected setting
		Digit selection to the left

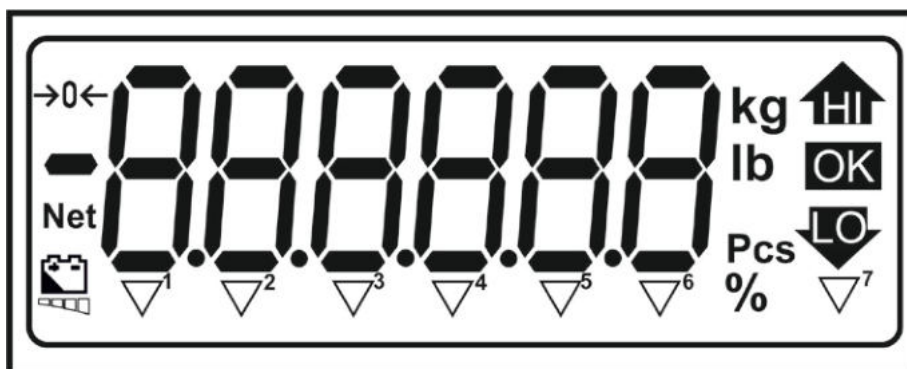

2.2 Overview of display



HI / OK / LO	Indicators for weighing with tolerance range
Kg	Current selected unit of weight „kilograms“
Lb	Current selected unit of weight „pound“
Pcs	Indicator for counting
→0←	Zero indicator
Net	The displayed weighing value is a net weighing value
	Status of rechargeable battery





Non verified weighing systems:

Indicator [▼] next to symbol displays:

	▼ ¹	that the weight value is stable
GROSS	▼ ²	that the displayed weighing value is a gross weight value
	▼ ³	that the balance is set to unit counting mode
PRE-TARE	▼ ⁴	that a PRE-TARE value is stored
HOLD	▼ ⁵	that the indicated weight value is held in the display, until it is deleted.
M+	▼ ⁶	that data are stored in an accumulative memory
	▼ ⁷	That the current selected unit of weight is „oz“.

Verified weighing systems:

Indicator [▼] next to symbol displays:

	▼ ¹	that the weight value is stable
GROSS	▼ ²	that the displayed weighing value is a gross weight value
	▼ ³	that the balance is set to unit counting mode
PRE-TARE	▼ ⁴	that a PRE-TARE value is stored
	▼ ⁵	Display of the current weighing range of the connected platform
	▼ ⁶	
M+	▼ ⁷	that data are stored in an accumulative memory

3 Basic Information (General)

3.1 Proper use

The display unit acquired by you is used in combination with a load cell and serves to determine the weighing value of material to be weighed. It is intended to be used as a “non-automatic weighing system”, i.e. the material to be weighed is manually and carefully placed in the centre of the weighing plate. As soon as a stable weighing value is reached the weighing value can be read.

3.2 Improper Use

Do not use weighing system for dynamic weighing. In the event that small quantities are removed or added to the material to be weighed, incorrect weighing results can be displayed due to the “stability compensation“ in the display unit. (Example: Slowly draining fluids from a container on the balance.)

Do not leave permanent load on the weighing pan. This may damage the measuring system.

Impacts and overloading exceeding the stated maximum load (max) of the weighing plate, minus a possibly existing tare load, must be strictly avoided. Both, the weighing plate and the display unit may be damaged during this process.

Never operate display unit in explosive environment. The serial version is not explosion protected.

Changes to the display unit's design are not permitted. This may lead to incorrect weighing results, safety-related faults and destruction of the display unit.

The display unit may only be operated in accordance with the described default settings. Other areas of use must be released by KERN in writing.

3.3 Warranty

Warranty claims shall be voided in case

- Our conditions in the operation manual are ignored
- The appliance is used outside the described uses
- The appliance is modified or opened
- Mechanical damage or damage by media, liquids, natural wear and tear
- The appliance is improperly set up or incorrectly electrically connected
- The measuring system is overloaded

3.4 Monitoring of Test Resources

In the framework of quality assurance the measuring-related properties of the display unit and, if applicable, the testing weight, must be checked regularly. The responsible user must define a suitable interval as well as type and scope of this test. Information is available on KERN's home page (www.kern-sohn.com) with regard to the monitoring of display units' test substances and the test weights required for this. In KERN's accredited DKD calibration laboratory test weights and display units may be calibrated (return to the national standard) fast and at moderate cost.

4 Basic Safety Precautions

4.1 Pay attention to the instructions in the Operation Manual



- Carefully read this operation manual before setup and commissioning, even if you are already familiar with KERN balances.
- All language versions contain a non-binding translation. The original German is binding.

4.2 Personnel training

The appliance may only be operated and maintained by trained personnel.

5 Transport and storage

5.1 Testing upon acceptance

When receiving the appliance, please check packaging immediately, and the appliance itself when unpacking for possible visible damage.

5.2 Packaging / return transport



- Keep all parts of the original packaging for a possibly required return.
- Only use original packaging for returning.
- Prior to dispatch disconnect all cables and remove loose/mobile parts.
- Reattach possibly supplied transport securing devices.
- Secure all parts such as the glass wind screen, the weighing platform, power unit etc. against shifting and damage.

6 Unpacking and placing

6.1 Installation Site, Location of Use

The display units are designed in a way that reliable weighing results are achieved in common conditions of use.

Precise and fast work is achieved by selecting the right place for your display unit and your weighing plate.

On the installation site observe the following:

- Place the weighing system on a firm, level surface;
- Avoid **extreme heat as well as temperature fluctuation** caused by installing next to a radiator or in the direct sunlight;
- Protect the display unit and the weighing plate against direct draft from open windows or doors.
- Avoid jarring during weighing;
- Protect the display unit and the weighing plate against high humidity, vapours and dust.
- Do not expose the display unit to extreme dampness for longer periods of time. Non-permitted condensation (condensation of air humidity on the appliance) may occur if a cold appliance is taken to a considerably warmer environment. In this case, acclimatize the disconnected appliance for ca. 2 hours at room temperature.
- Avoid static charge of goods to be weighed or weighing container.

Major display deviations (incorrect weighing results) may be experienced should electromagnetic fields (e.g. due to mobile phones or radio equipment), static electricity accumulations or instable power supply occur. Change location or remove source of interference.

6.2 Unpacking and placing

Take the display unit carefully out of its packaging, remove the plastic jacket and install it at the designated work space. Mount the display unit in a way that facilitates operation and where it is easy to see.

6.3 Scope of delivery / serial accessories:

- For display unit, see chapter 2
- Plug for connection to load cell
- Operating manual

6.4 Transport Securing

Remove the transportation safety device at the four marked positions:



Transport Securing

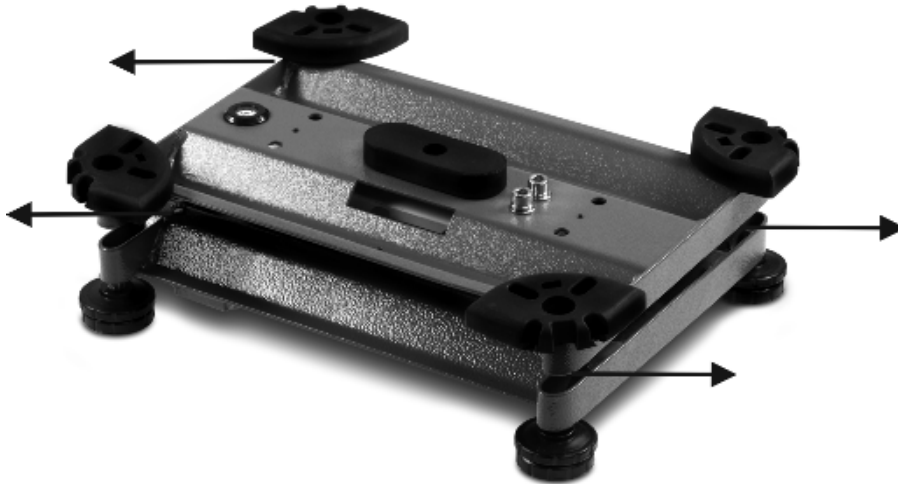

6.5 Placing

Mount the display unit in a way that facilitates operation and where it is easy to see.

i In order to raise the display, the display device can be mounted on an optional stand.

6.6 Mains connection

Power is supplied via the external power supply unit.

Insert the mains plug into the wall socket.

Once connected, the instrument performs a self check. If the zero display shows the device is ready for use.

6.7 Rechargeable battery operation (Factory option)

Charge the battery for at least 12 hours before initial use.

The battery symbol indicates the current charge level of the batteries. If the symbol



flashes, the capacity of the battery will soon be exhausted. The weighing scale will remain ready for operation for a few more hours before switching off in order to save battery. Fully charge the battery pack.

6.8 Adjustment

As the acceleration value due to gravity is not the same at every location on earth, each display unit with connected weighing plate must be coordinated - in compliance with the underlying physical weighing principle - to the existing acceleration due to gravity at its place of location (only if the weighing system has not already been adjusted to the location in the factory). This adjustment process must be carried out for the first commissioning, after each change of location as well as in case of fluctuating environment temperature. To receive accurate measuring values it is also recommended to adjust the display unit periodically in weighing operation.

How to carry out adjustment:

- **Unverified weighing systems, see chapter 11**
- **Verified weighing systems, see chapter 19.3**

6.9 Verification

General introduction:

According to EU directive 90/384/EEC or 2009/23EG balances must be officially verified if they are used as follows (legally controlled area):

- a) For commercial transactions if the price of goods is determined by weighing.
- b) For the production of medicines in pharmacies as well as for analyses in the medical and pharmaceutical laboratory.
- c) For official purposes
- d) For manufacturing final packages

In cases of doubt, please contact your local trade in standard.

Verification notes:

An EU type approval exists for the appliance described in its technical data as verifiable. If the appliance is used where obligation to verify exists as described above, it must be verified and re-verified at regular intervals.

Re-verification of an appliance is carried out according to the respective national regulations. Normally the validity for verification in Germany is e.g. 2 years.

The legal regulation of the country where the balance is used must be observed!



Verification of the device is invalid without the seals.

The seal marks / verification wire attached on verified appliances point out that the appliance may only be opened and serviced by trained and authorised specialist staff. If the sealing (paper seal/ verification wire) is damaged, the verification validity expires. Please observe all national laws and legal regulations. In Germany a re-verification will be necessary.

Sealing:

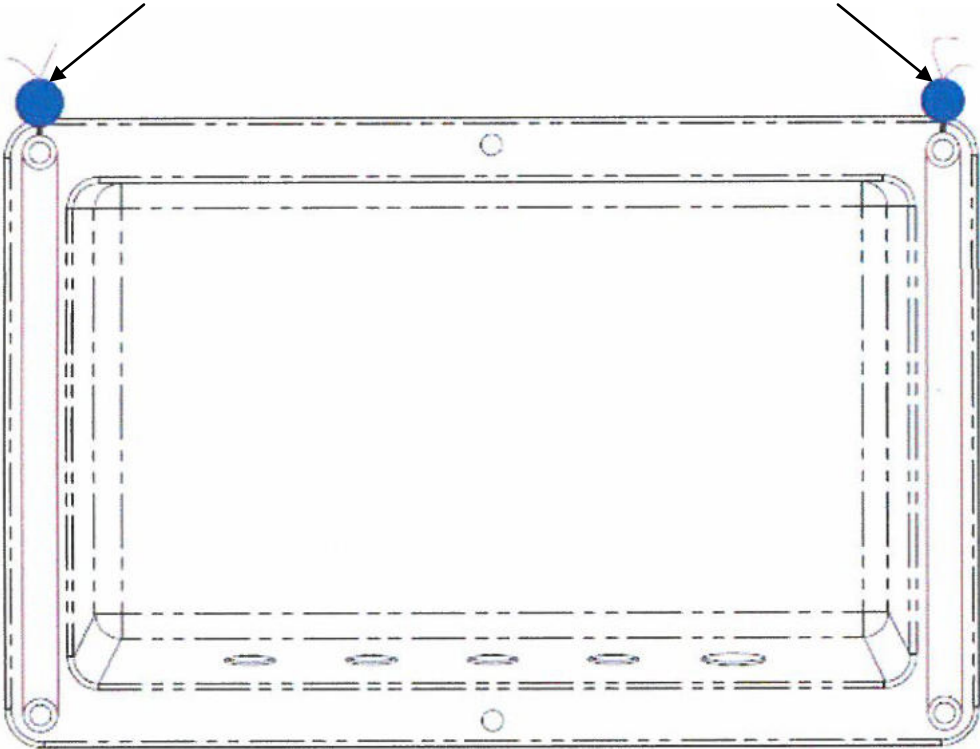

7 Basic Operation

7.1 Start-up

- ⇒ Press on/ off key, the equipment completes a self check. As soon as the weight display appears, the instrument will be ready to weigh.



7.2 Switching Off

- ⇒ Press the on/ off key approx. 3 seconds, the display will turn off.

7.3 Zeroing

Resetting to zero corrects the influence of light soiling on the weighing plate.

Manual

- ⇒ To unload the weighing system
- ⇒ Press the ZERO button, the zero display and the indicator '→0←' will appear.



Automatic

- ⇒ The automatic zero tracking menu, can be switched on or off, function "FNC 13" see chapter 10.10.
When the balance is cleared the zero point is corrected automatically.

7.4 Simple weighing

- ⇒ Place goods to be weighed on balance.
- ⇒ Wait until the indicator ▼ over the stability display ▽ appears.
- ⇒ Read weighing result.



7.5 Switch-over weighing unit

⇒ Press the UNIT-key

The weight gauge changes between „kg“and "g".

7.6 Weighing with tare



After taring no numeric input of a tare weight can follow.

After the numeric input of a tare weight, the system can only be tared if „tare weight > PRE TARE value“

7.6.1 Taring

⇒ Deposit weighing vessel. Wait for stability display, then press the TARE button
Zero display and indicator net appear.



- ⇒ The weight of the container is now internally saved.
- ⇒ Weigh the material, the net weight will be indicated.
- ⇒ After removing the weighing container, the weight of the weighing container appears as negative display.
- ⇒ The taring process can be repeated any number of times, e.g. when adding several components for a mixture (adding). The limit is reached when the whole weighing range is exhausted.
- ⇒ With the BG/ NET key you can switch between gross weight and net weight, see chapter 7.7.

7.6.2 Delete tare

- ⇒ Unload balance and press the TARE key.
The NET indicator turns off, the zero display shows.

7.6.3 Numerical input of tare (PRE-TARE)

The known dead weight of a weighing container can be tared off by entering its weight as pre-tare deduction in order to ensure the net weight of the goods to be weighed in subsequent weighings is always displayed.

⇒ Press the TARE- key, the active position flashes.

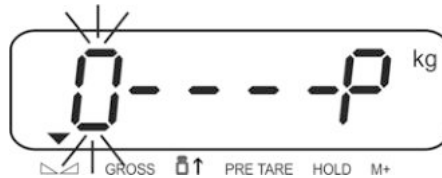

⇒ Enter the known tare weight, e.g. 2 kg and acknowledge with TARE button. Numerical input, see chap. 2.1.1.



The entered weight will be stored as tare weight and displayed with negative sign. The indicator ▼ over PRE-TARE will appear.



⇒ Put the filled weighing container on the balance, the net weight will be displayed.
⇒ The tare value remains stored until it is deleted with the TARE key.

7.7 Gross/Net call-up

By repeated pressing of the BG/ NET key you can change between the gross and net indicator values.

At the indicator „gross weight“ the indicator appears ▼ above **LARGE**.
In the „Net weight“ display the indicator appears next to **NET**.

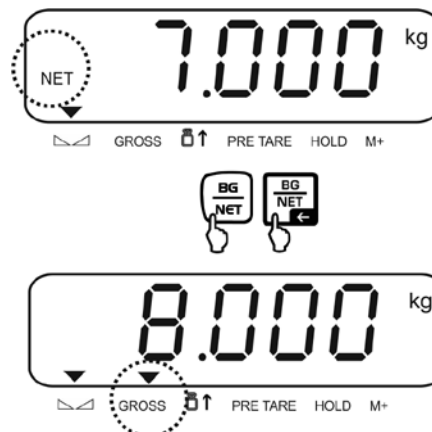

8 Applications:

8.1 Parts counting

Before the balance can count parts, it must know the average part weight (i.e. reference). Proceed by putting on a certain number of the parts to be counted. The balance determines the total weight and divides it by the number of parts, the so-called reference quantity. Counting is then carried out on the basis of the calculated average piece weight.

As a rule:

The higher the reference quantity the higher the counting exactness.



Required setting in the menu:

Function <CFn7> → <PCS on>, see chapter 19.5.6

Determine the unit weight and count

1. In the weighing mode press the unit key, in order to activate the counting function. The indicator Pcs is indicated.



2. Press the BG/NET-key repeatedly until the desired reference number of items (e.g. 100) appears, select between C 10, C 20, C 50, C100, C 200.

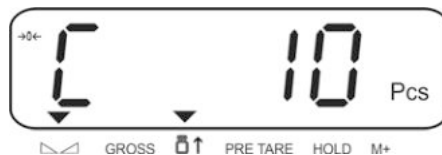

3. Place as many items to be counted (such as 10 items) as demanded by the set reference quantity and confirm by UNIT key. The weighing scales calculate the reference weight. The current number of items (e.g. 10 pieces) is indicated.

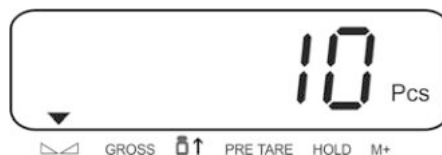

4. Remove reference weight. The balance is from now in parts counting mode counting all units on the weighing plate.

Switch between number of items and weight

With the UNIT key you can switch between number of items and weight:



By switching the scale off and then on again the scale starts in the unit counting mode. The current reference weight remains stored until the reference is set again or the power supply is interrupted.

The counting function is not active, if the weight is under 20d or if below the minimum piece weight ($< 0.2 D$) is reached.

Automatic reference optimization

In order to improve the counting exactness, the reference can be optimised by adding more pieces. At every reference optimisation, the reference weight is calculated anew. As the additional pieces increase the base for the calculation, the reference also becomes more exact.

⇒ If the number of placed parts are 5 pieces more than the reference, then the automatic reference optimisation starts. The reference weight is calculated anew.

8.2 Totalization

Required settings in the menu:

1. Function „rSi 04“: Setting „M_Plus“, see chapter 12.4
2. Function „rSi 03“, setting F_M 10 or F_M11 (sample print-out see following overview, see chapter 12.3.

F_M 10 (M+ accumulating mode 1): Total = sum of net weight of each weight reading	F_M 11 (M+ accumulating mode 2): Total = Sum of gross weight of each weight reading
Printout example (KERN YKB-01N)	Printout example (KERN YKB-01N)
<div style="border: 1px dashed black; padding: 5px;"> <pre> 07:58 05/09/13 TICKET NO.0001 DATE:2010/04/16 TIME: 15:56:48 G + 1.500 kg T + 0.500 kg N + 1.000 kg 07:58 05/09/13 TICKET NO.0002 DATE:2010/04/16 TIME: 15:56:56 G + 5.500 kg T + 0.500 kg N + 5.000 kg 07:59 05/09/13 TOTAL NUMBER OF TICKETS 0002 DATE:2010/04/16 TIME: 15:57:14 G + 0.000 kg T + 0.000 kg N + 0.000 kg TOTAL NET + 6.000 kg </pre> </div> <p style="text-align: right;">1. Weighing</p> <p style="text-align: right;">2. Weighing</p> <p style="text-align: right;">Output Accumulation memory</p> <p style="text-align: right;">Sum of net weight of each weight reading</p>	<div style="border: 1px dashed black; padding: 5px;"> <pre> 07:56 05/09/13 TICKET NO.0001 DATE:2010/04/16 TIME: 15:54:26 G + 1.500 kg T + 0.500 kg N + 1.000 kg 07:56 05/09/13 TICKET NO.0002 DATE:2010/04/16 TIME: 15:54:36 G + 5.500 kg T + 0.500 kg N + 5.000 kg 07:56 05/09/13 TOTAL NUMBER OF TICKETS 0002 DATE:2010/04/16 TIME: 15:54:47 G + 0.000 kg T + 0.000 kg N + 0.000 kg TOTAL WEIGHT + 7.000 kg </pre> </div> <p style="text-align: right;">1. Weighing</p> <p style="text-align: right;">2. Weighing</p> <p style="text-align: right;">Output Accumulation memory</p> <p style="text-align: right;">Gross weight of each weight reading</p>



The totalizing function is not active when the weight is under 20d.

Add up:

- ⇒ Place weighing good A, e.g. 5 kg.
Wait for stability, then press M + / PRINT key. . The weight is added to the accumulative memory and printed if an optional printer is connected. The number of weighings, followed by the total weight will be indicated. The indicator ▼ above M+ shows.

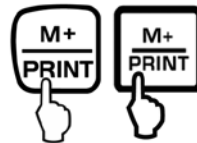

- ⇒ Remove the weighed good. More weighed goods can only be added when the display \leq zero.



- ⇒ Place goods to be weighed, e.g. 7 kg.
Wait for stability then press the M+/PRINT, it calculates. The weight value is added to the accumulative memory and given out when connecting an optional printer. Number of weighings, followed by the total weight will be displayed for 2 sec. Then the current weight value appears, the indicator ▼ above M + appears.

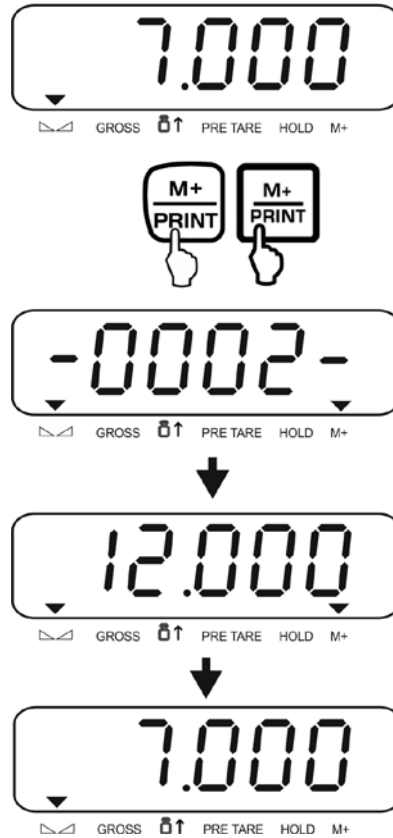

- ⇒ Add more weighed goods as described before. Please note that the weighing system must be unloaded between the individual weighing procedures.
- ⇒ You can repeat this process until the capacity of the weighing system is exhausted.

Display and output sum „Total“:

- ⇒ When the scale is unloaded (zero indicator) press the M+/PRINT key, the number of weight readings followed by the total weight are indicated for 2 seconds. Press M+/PRINT to print out this display.

Delete accumulative memory:

1. With M+/PRINT :
At the display “Number of weighings” press M+/PRINT key again. The data in the accumulative memory are deleted. The indicator ▼ above **M+** turns off.
2. With F
in the menu use the function "FnC 12" in setting "MC" to allocate the F-key with the function "Delete accumulative memory", see chapter 10.9
When the scale is **unloaded** (zero indicator) press the F-key, the data in the accumulative memory are deleted. The indicator ▼ above **M+** turns off.

9 Menu

The menu consists of the following blocks:

01 Fnc	Settings of the display device
02 EC	External adjustment
03 rbi	Settings of the interface
00 ESC	Exit menu / back to weighing mode.

Access to menu:

⇒ In the weighing mode press the BG/NET and ZERO key simultaneously, "01 Fnc" is indicated.

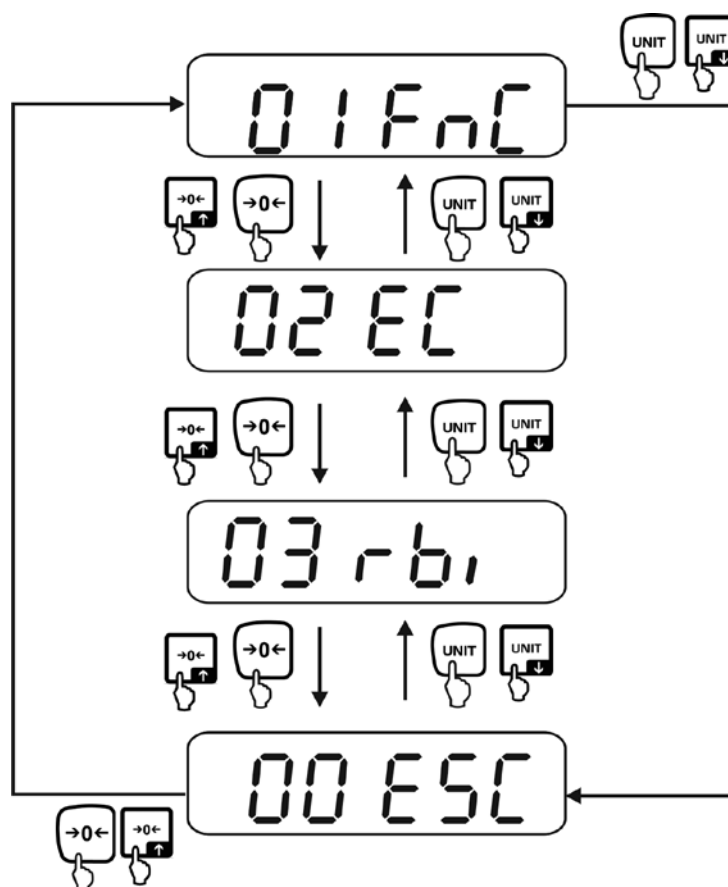





10 Indicator settings (menu block "01 FnC")

Access to menu:

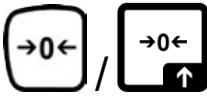
⇒ In the weighing mode press BG/ NET and ZERO key simultaneously "01 FnC" is indicated, see chapter 9.

Keys and their function in the menu:

	↑	<ul style="list-style-type: none"> • Increase flashing digit • Scroll forward in menu
	↓	<ul style="list-style-type: none"> • Decrease flashing digit • Scroll backwards in menu
	→	Digit selection to the right
	←	Digit selection to the left

Call up the navigation in the menu/ function:

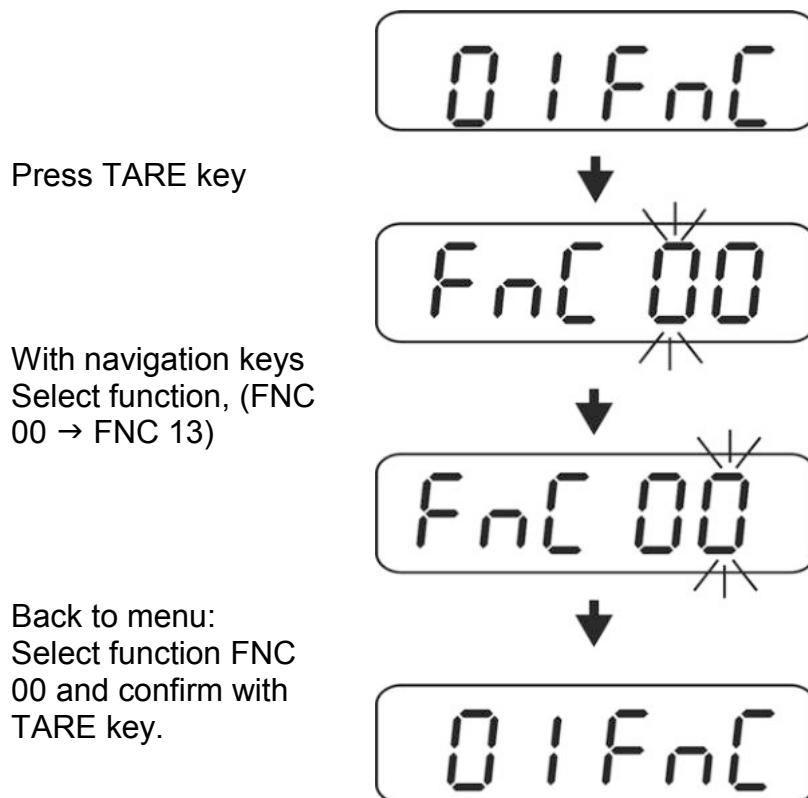

Exit menu / back to weighing mode:

⇒ Leave the example function "FnC 01"

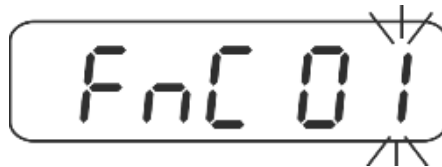

⇒ Select with the navigation keys "FnC 00" and confirm with TARE key.

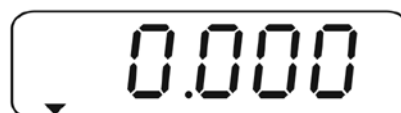
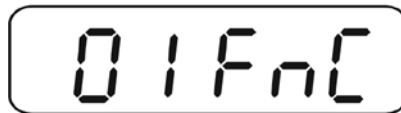
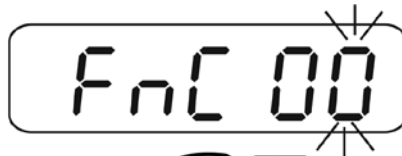

Overview:

FnC 00	Exit menu
FnC 01	Display background illumination
FnC 02	Automatic power switch-off
FnC 03	Weighing with tolerance range / set limit values
FnC 04	Reset to default setting
FnC 05	Automatic zero tracking / stability and response settings
FnC 06	Data-Hold function
FnC 07	Automatic reference optimization with counting of items
FnC 08	Not documented
FnC 09	Not documented
FnC 10	Automatic saving of zero point (not available in the case of weighing systems with type approval).
FnC 11	Not documented
FnC 12	Function of the F-key
FnC 13	Auto-Zero function (not available with balancing systems with approved design)

10.1 Backlighting of the display (function "FnC 01")

⇒ Call up function "FnC 01", see chapter 10 „Navigation in the menu“.

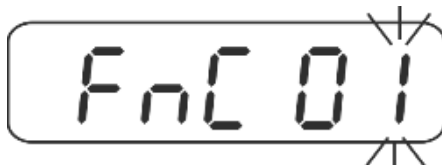

- ⇒ Press the TARE-key , the current setting for the back lighting of the display is indicated.
- ⇒ Select desired settings with TARE or UNIT key.

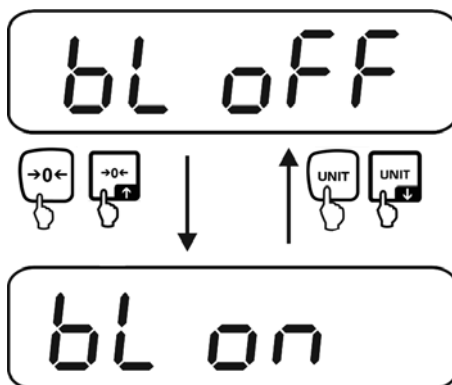

bl off	Display background illumination off
bl on	Starting from a weight > 10 d the back lighting of the display is switched on automatically. If there is no activity at the appliance for 10 seconds or at the zero indicator the back lighting is switched off automatically.

⇒ Confirm with the TARE key, the display returns back to the menu.

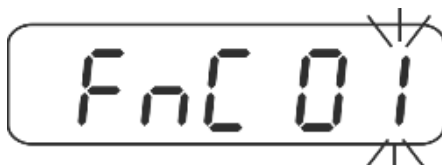

⇒ Return to weighing mode, see chap. 10.

10.2 Automatic power cut "Auto power off (function „FnC 02“)

⇒ Call up function "FnC 02", see chapter 10 "Navigation in the menu".

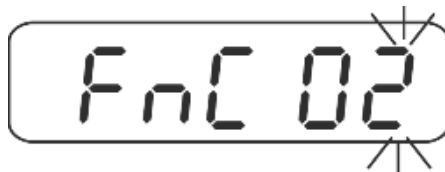

- ⇒ Press the TARE-key, current setting appears.
- ⇒ Select desired settings with TARE or UNIT key.

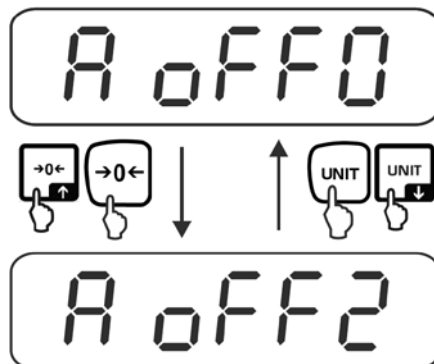

A off0	Function switched off
A off1 ↓ A off9	The indicator is switched off automatically within the adjusted time, if the weighing system is not used and/ or the weight < 10 D. Selectable between 1 - 9 minutes.

⇒ Confirm with the TARE key, the display returns back to the menu.

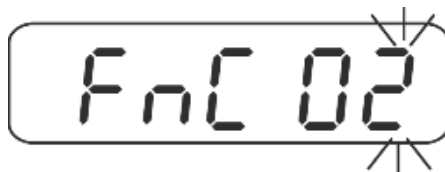



⇒ Return to weighing mode, see chap. 10.

10.3 Weighing with tolerance range (function "FnC 03 „)

You can set an upper or lower tolerance limit when weighing with tolerance range and thus ensure that the weighed load remains exactly within the set tolerance limits. Tolerance checks such as dosing, portioning and sorting the display above or below the tolerance levels with a visual and acoustic signal (depending on the setting in the menu).

Optical signal:

Three indicators show whether the material being weighed is located within the two tolerance limits. The indicators provide the following information:

	Weight less than nominal weight and below the lower tolerance
	Weight within tolerance limits
	Weight more than the nominal weight and above the upper tolerance

Settings:

⇒ Call up function "FnC 03", see chapter 10 "Navigation in the menu".

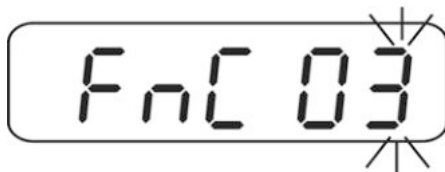

⇒ Press the TARE key, the current settings of the upper tolerance is indicated.



⇒ With the navigation keys (see chapter XX) enter the desired value e.g. 3 kg.



⇒ Press the TARE key repeatedly until the display for the input of the lower tolerance appears.



⇒ With the navigation keys (see chapter 2.1.1) Enter the desired value e.g. 2.9 kg.

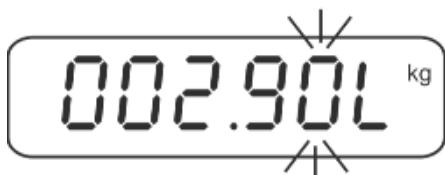

- ⇒ Press the TARE key until the display for the settings of the audio signal appears. The current setting will be displayed.



- ⇒ With the navigation keys (see chapter 2.1.1) select the desired setting.



Settings of audio signal:

000006

(a)(b)(c)

Selectable mode	Description
(a) ⇒	1 = Audio signal switched on 0 = Audio signal switched off
(b) ⇒	1 = Audio signal sounds with stable weight values 0 = Audio signal sounds with unstable weight values
(c) ⇒	1 = If the object to be weighed is within the tolerance range, the acoustic signal sounds will be emitted. 0 = If the material being weighed lies outside the tolerance range and > 10 d the acoustic signal sounds.

- ⇒ Confirm with the TARE key, the display returns back to the menu.

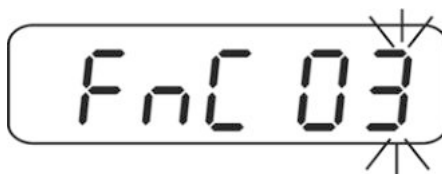

- ⇒ Return to weighing mode, see chap. 10.

Weighing with tolerance range:

- ⇒ Tare when using a weighing container.
- ⇒ Put on goods to be weighed, tolerance control is started. The indicators show whether the load is within the two set tolerance limits.

Load below specified tolerance	Load within specified tolerance	Load exceeds specified tolerance
 <p>2.700^{kg} ↓</p> <p>☒ GROSS ⬆ PRE TARE HOLD M+</p>	 <p>2.907^{kg} OK</p> <p>☒ GROSS ⬆ PRE TARE HOLD M+</p>	 <p>3.077^{kg} ↑</p> <p>☒ GROSS ⬆ PRE TARE HOLD M+</p>
Indicator  illuminated	Indicator  illuminated	Indicator  illuminated

i To deactivate the function for the tolerance levels enter the value „00.000 kg“.

10.4 Resetting to factory settings (function "FnC 04 ,,)

The following functions are reset to factory setting with "FnC 04 ,,.

1. External adjustment weight
2. Settings for weighing with tolerance range
3. Filter settings
4. Settings of number of items

⇒ Call up function "FnC 04", see chapter 10 "Navigation in the menu".

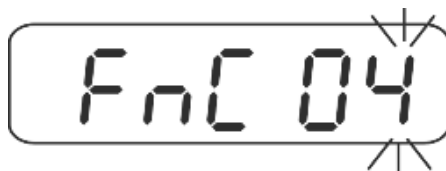

⇒ Press the TARE key.

⇒ Select desired settings with TARE or UNIT key.

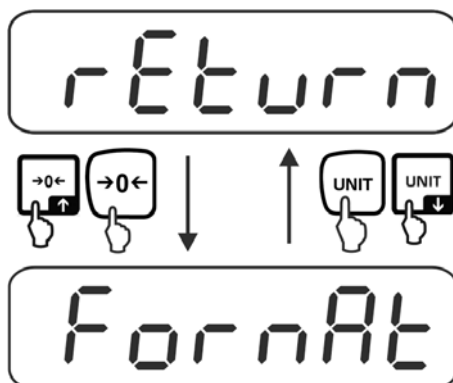

return	No resetting to factory settings
format	Reset to default setting

⇒ Confirm with the TARE key, the display returns back to the menu.

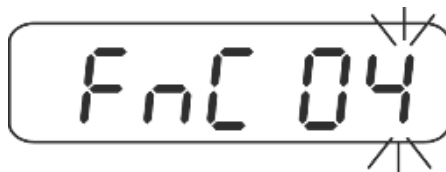

⇒ Return to weighing mode, see chap. 10.

10.5 Automatic zero-adjusting/ stability and response settings (function "FnC 05")



This function is only available for unverified weighing systems (CFn 02 = 0), for verified weighing systems see chapter 19.5.1.

⇒ Call up function "FnC 05", see chapter 10 "Navigation in the menu".

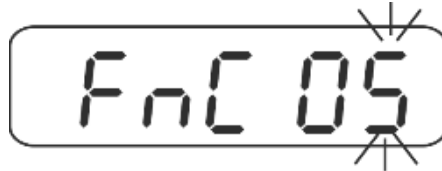

⇒ Press the TARE-key, current setting appears.

⇒ Select desired settings with TARE or UNIT key.

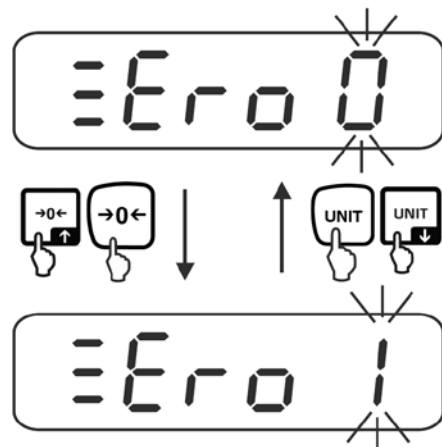

Zero 0	Switch Automatic zero-adjusting switch on and off and select zero range.
↓	
Zero 9	You can select 0 (switched off), 1d, 2d, 3d, 4d, 5d, 6d, 7d, 8d, 9d

⇒ Confirm with TARE key, the current stability settings are indicated.

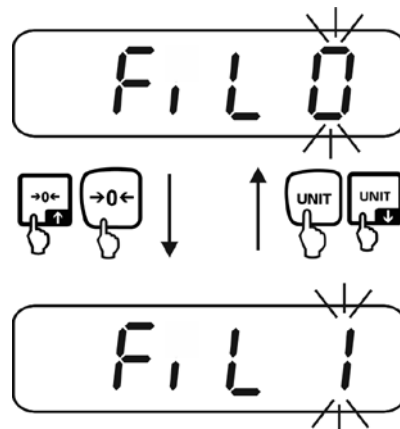

FIL 0 ↓ FIL 9	The higher the value, the more priority is given to stability. You can select 0-9. Factory setting "0".
-----------------------------------	--

⇒ Confirm with the TARE key, the current response level is displayed.

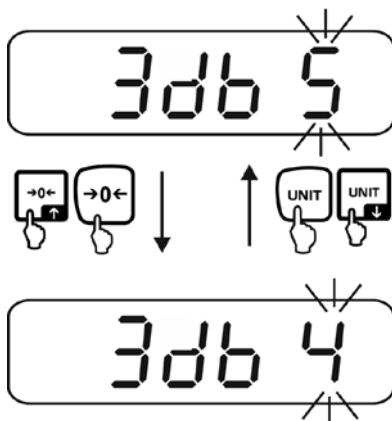

3 db 0 ↓ 3 db 9	The higher the value, the more priority is given to response. You can select 0-9. Factory setting "5".
-------------------------------------	---

i With the functions "FIL" and "3 DB", there is the possibility to select the stability of the display and the degree of reaction of the weighing system on the requirements of specific applications or environmental conditions.
 Please note that in general slowing down reaction times result in higher stability of the set data handling, while speeding up reaction times have an influence on the stability deterioration.

⇒ Confirm with the TARE key, the display returns back to the menu.

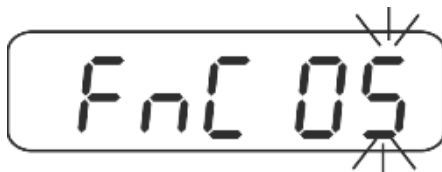

⇒ Return to weighing mode, see chap. 10.

10.6 Data Hold functions (function "FnC 06")



With verified balancing systems (Cfn 02 = 1) the setting „hold = 0“ cannot be altered with the function „FnC 06“ (changes are possible with function "CFn 05" see chapter 19.5.4.).

⇒ Call up function "FnC 06", see chapter 10 "Navigation in the menu".

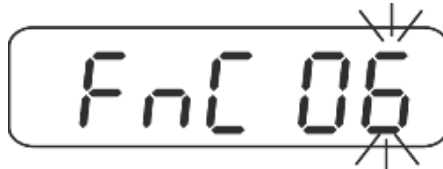

⇒ Press the TARE-key, current setting appears.

⇒ Select desired settings with TARE or UNIT key.

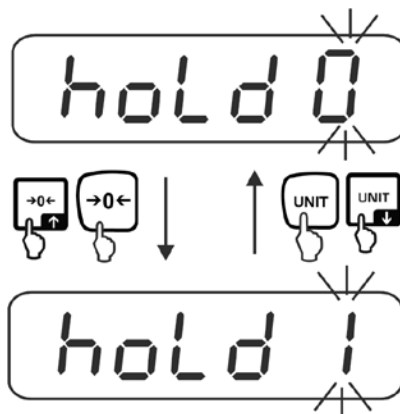

hold 0	Function switched off (factory setting)
hold 1	Peak value function This function indicates the highest load factor (peak value) of a continuously rising load. The peak value remains in the display until it is deleted with any key.
hold 2	„Stable hold 1“ mode The weight value is held automatically after reaching a stable value up to the manipulation of any key in the display.
hold 3	„Stable hold 2“ mode The weight value is held in the display after reaching a stable value until the load falls under 10d.
hold 4	Animal weighing This function is suitable for jerky weighing procedures, see following chapter 10.6.1

⇒ Confirm with the TARE key, the display returns back to the menu.



⇒ Return to weighing mode function, see chap. 10.

10.6.1 Animal weighing function

With this function jerky balancing goods can be weighed, e.g. living animals. The scale calculates an average value by the number of adjusted weighings and displays this until the scale is cleared (display < 10d).

Settings:

⇒ Call up setting "hold 4", see. chapter 10.6.



⇒ Press the TARE-key, current setting appears.

⇒ Select desired settings with TARE or UNIT key.

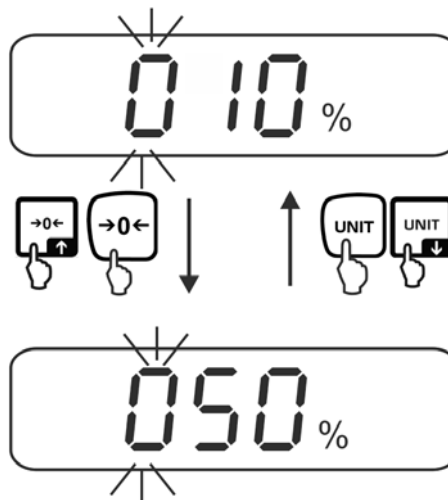

1%	Range of display fluctuation, you can select 1 -100%. Factory setting „10“
↓	
100%	

⇒ Press the TARE key repeatedly until the current setting "number of weight readings" is indicated.

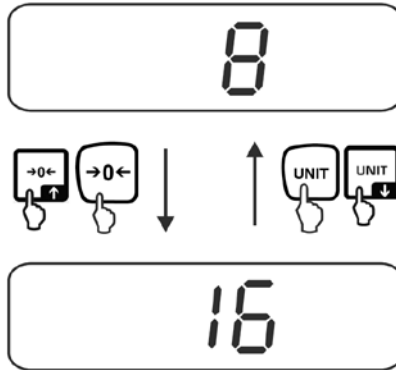

1 ↓ 64	Number of weight readings, which are consulted for the average value calculation, you can select 1, 2, 4, 8, 16, 32, 64. Factory setting "8"
----------------------------	--

⇒ Confirm with the TARE key, the display returns to the menu.

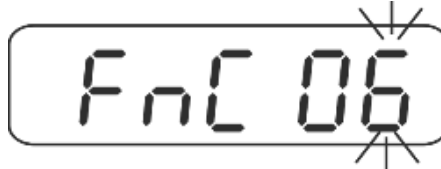

⇒ Select with the navigation keys "FNC 00" and confirm with TARE key.

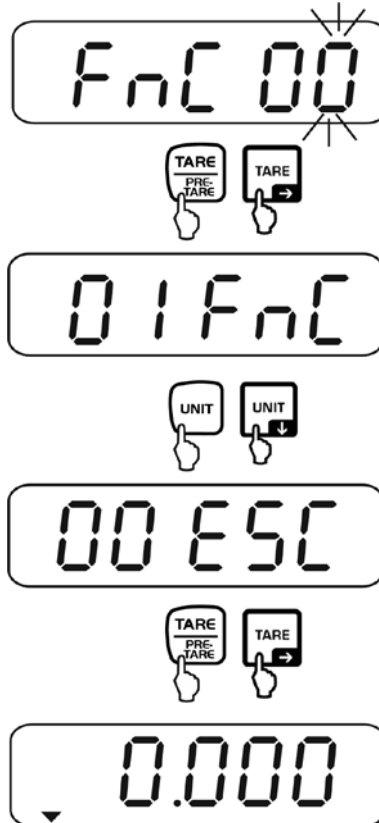

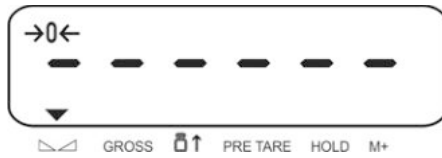

From now on the scale is in animal weighing mode.

Animal weighing:

When the animal weighing function is activated horizontal segments appear at the zero display.

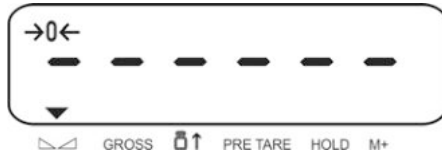

⇒ Place goods to be weighed on the balance. The scale calculates the average value by the number of adjusted weight readings. The indicator ▼ appears above HOLD.



⇒ For further measurements unload the scale.

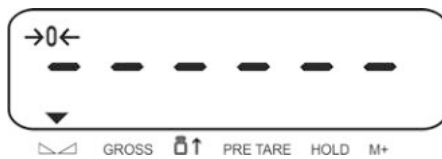

Return to weighing mode:

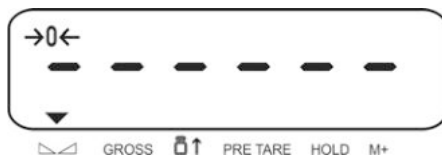

- ⇒ In the weighing mode press the BG/NET and ZERO key simultaneously, "01 FnC" is indicated. Press the TARE key, „FNC 00" is indicated.

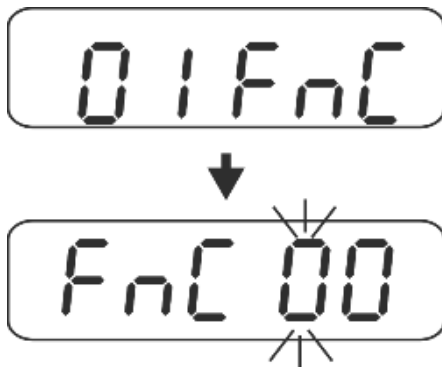

- ⇒ Select „FnC 00" with the navigation keys and confirm with the TARE key. „hold 4" is indicated.

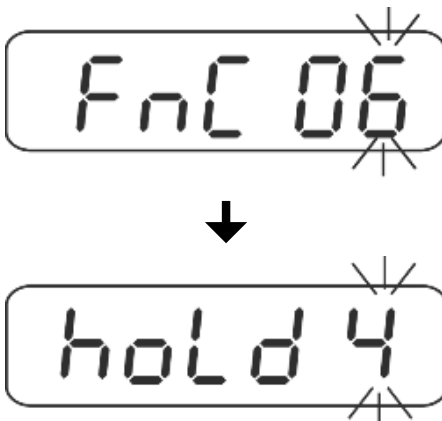

- ⇒ Select „hold 0" with the navigation keys and confirm with the TARE key.

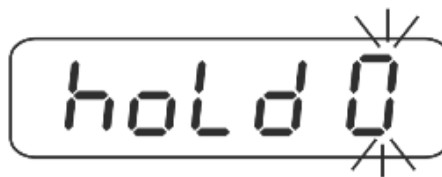

- ⇒ Confirm with the TARE key, the display returns back to the menu.

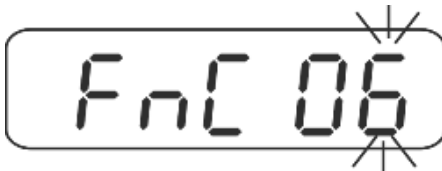

- ⇒ Select with the navigation keys "FNC 00" and confirm with TARE key.

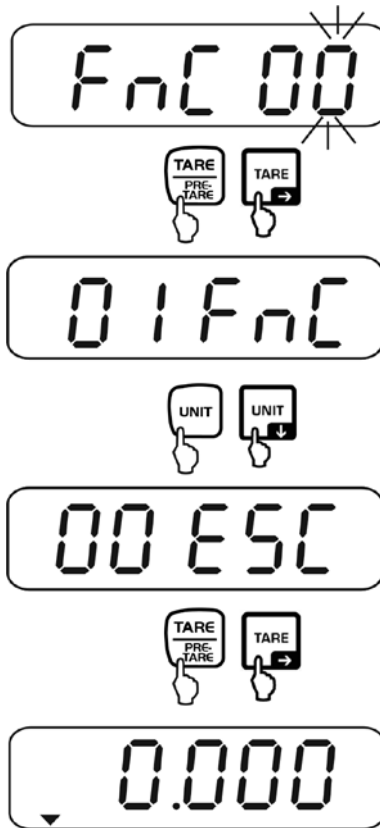

10.7 Automatic reference optimisation with the unit count (function „FnC 07“)

⇒ Call up function „FnC 07“, see chapter 10 "Navigation in the menu“.

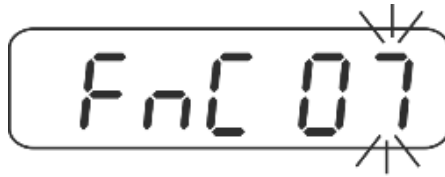

- ⇒ Press the TARE-key, current setting appears.
- ⇒ Select desired settings with TARE or UNIT key.

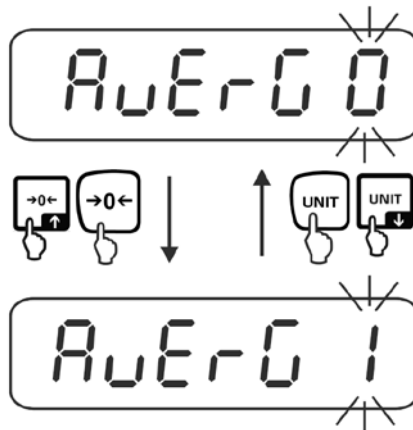

AvErG 0	No reference optimisation
AvErG 1	Reference optimisation is activated. The device automatically determines the weight per unit again, if the number of parts has increased

⇒ Confirm with the TARE key, the display returns back to the menu.

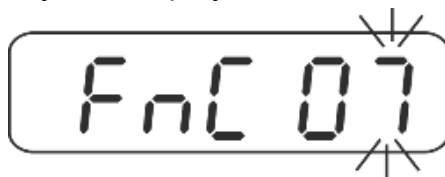

⇒ Return to weighing mode, see chap. 10.

10.8 Automatic storage of zero point (function "FnC 10")



This function is only available for unverified weighing systems (CFn 02 = 0).

⇒ Call up function "FnC 10", see chapter 10 "Navigation in the menu".

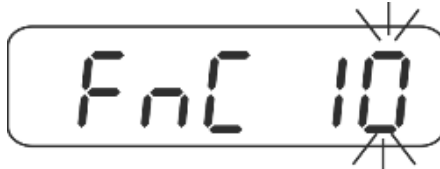

- ⇒ Press the TARE-key, current setting appears.
- ⇒ Select desired settings with TARE or UNIT key.

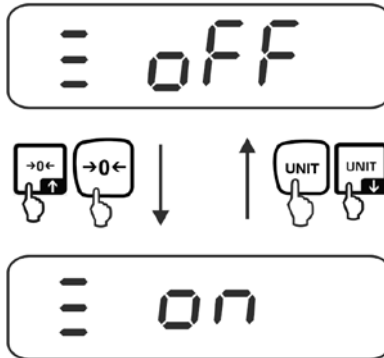

off	Function switched off (factory setting)
on	If the function is switched on, the last zero point is stored. After switching the appliance off and on or after a power failure the equipment with the stored zero point continues to work.

⇒ Confirm with the TARE key, the display returns back to the menu.

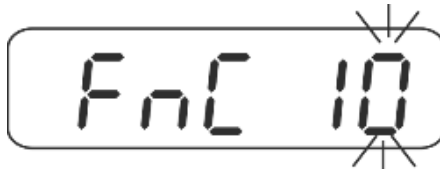

⇒ Return to weighing mode, see chap. 10.

10.9 Function of the F-key (function „FnC 12“)

⇒ Call up function "FnC 12", see chapter 10 "Navigation in the menu".

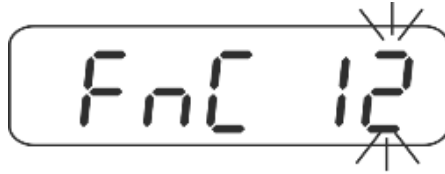

- ⇒ Press the TARE-key, current setting appears.
- ⇒ Select desired settings with TARE or UNIT key.

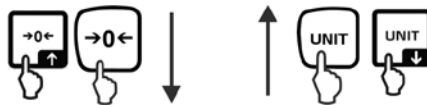

3 different functions can be assigned to the F-key:	
MC	The accumulative memory is cleared when the F-key is pressed.
hr	The weight value 10 x higher resolution is displayed when the F key is pressed.
t-tP	PRE-TARE

⇒ Confirm with the TARE key, the display returns back to the menu.

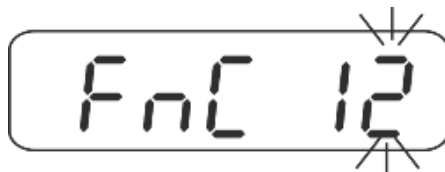

⇒ Return to weighing mode, see chap. 10.

10.10 Auto Zero

This function is used to tare small variations in weight automatically. In the event that small quantities are removed or added to the material to be weighed, incorrect weighing results can be displayed due to the “stability compensation”. (e.g. slow flow of liquids from a container placed on the balance, evaporating processes).

When apportioning involves small variations of weight, it is advisable to switch off this function.



This function is only available for unverified weighing systems (CFn 02 = 0). For verified weighing systems see chapter 19.5.5

⇒ Call up function "FnC 13", see chapter 10 "Navigation in the menu".

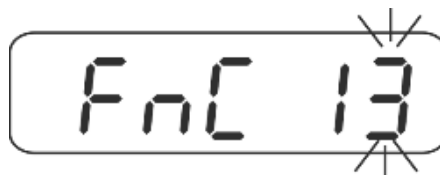

⇒ Press the TARE-key, current setting appears.

⇒ Select desired settings with TARE or UNIT key.

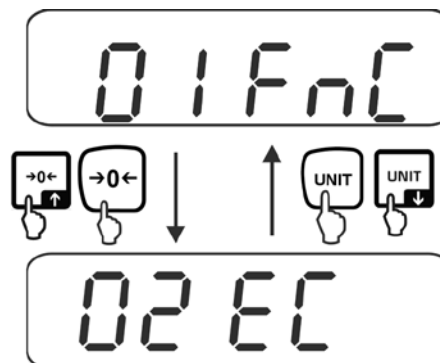

off	Function switched off (factory setting)
on	When the balance is cleared the zero point is corrected automatically.

⇒ Confirm with the TARE key, the display returns back to the menu.

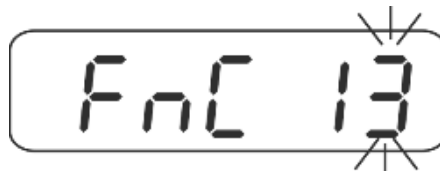

⇒ Return to weighing mode, see chap. 10.

11 External adjustment "Unverified weighing systems ,, (menu block "02 EC")

i	<ul style="list-style-type: none">• Prepare the required adjustment weight. The weight to be used depends on the capacity of the scale. Carry out adjustment as near as possible to the scale's maximum weight. Info about test weights can be found on the Internet at: http://www.kern-sohn.com.• Observe stable environmental conditions. Stabilisation requires a certain warm-up time.
----------	---

Procedure:

⇒ In the weighing mode press the BG/NET and ZERO key simultaneously, "01 FnC" is indicated. Select "02 EC" with the navigation keys.

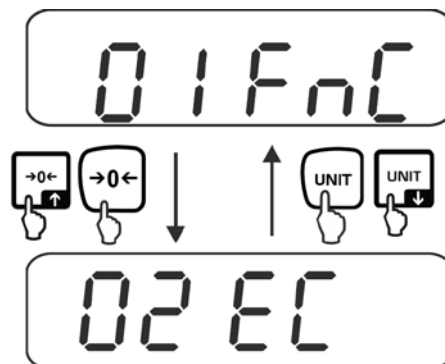

⇒ Press the TARE button, the currently set adjustment weight is displayed. The last digit flashes.

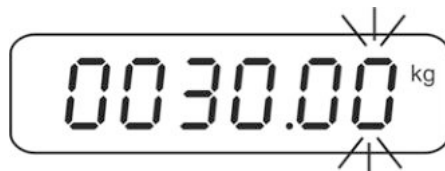

To change the adjustment weight select the digit to be changed with BG/ NET key, the active digit flashes. Enter the desired value with the navigation keys. Press the TARE key repeatedly, until "-----" is indicated.

⇒ Ensure that there are no objects on the weighing pan. Press the TARE key.

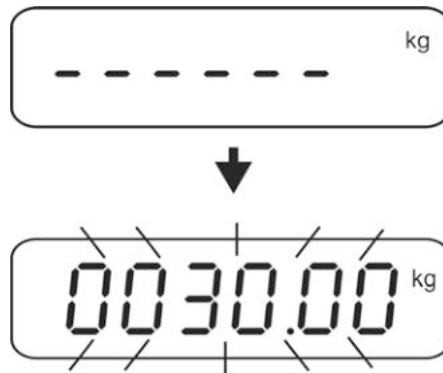

The weight value of the required adjustment weight will be displayed.

⇒ Carefully place the adjusting weight into the centre of the balancing plate and press the TARE key.

After successful adjustment, an acoustic signal sounds, the scale will automatically return to the menu. Take away adjustment weight.

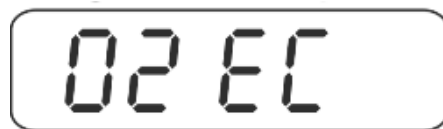

Cancel the adjustment:

Press the BG/ NET key repeatedly, until „PASS“ is indicated.

Press the BG/ NET key again, the display returns to the menu "02 EC".

Return to weighing mode:

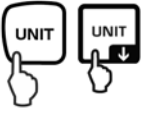
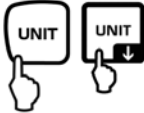

12 Settings RS 232 (menu block "03 rS1")

Access to menu:

⇒ In the weighing mode press the BG/NET and ZERO key simultaneously, "01 FnC" is indicated. Select "03 rS1" with the navigation keys.

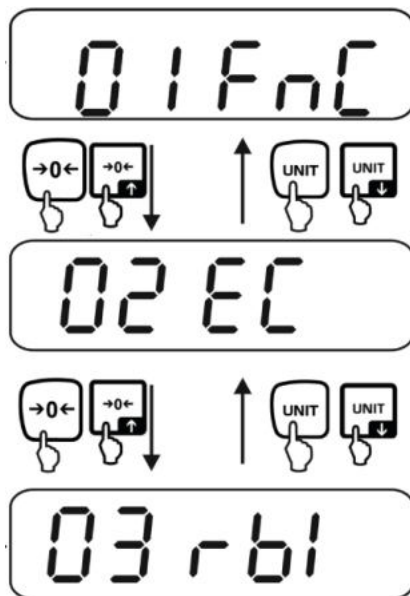

Call up the navigation in the menu/ function:

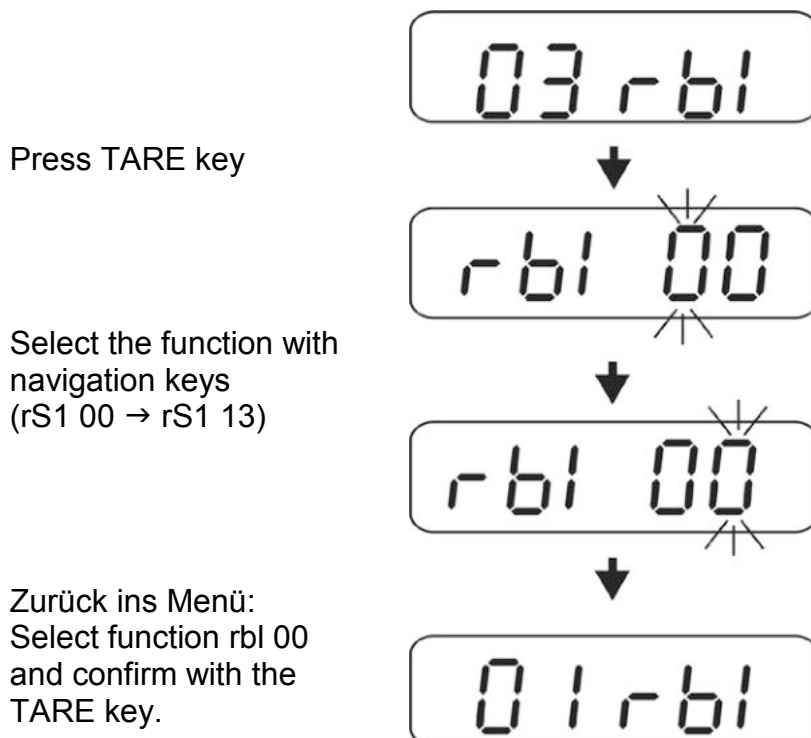

Keys and their function in the menu: see chap. 10

Exit menu / back to weighing mode:

⇒ For example to leave function "rS1 01"



⇒ Select "rS1 00" with the navigation keys and confirm with the TARE key.

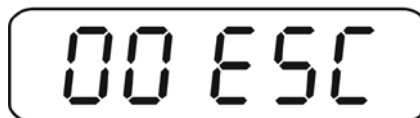
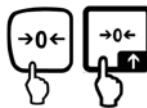
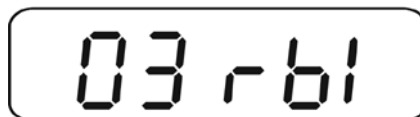
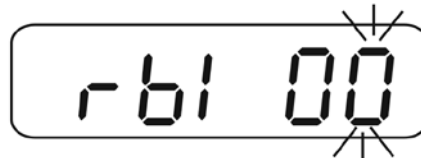

Overview:

rS1 00	Exit menu
rS1 01	Baud rate
rS1 02	Parity
rS1 03	Output format
rS1 04	Output mode
rS1 05	Continuous output rate
rS1 06	Automatic data output with zero display.
rS1 07	Not documented (Factory setting "0")
rS1 08	Set output stable/instable weighing values
rS1 09	6 /7 -digit data format
rS1 10	How to set date/time
rS1 11	Set the date format
rS1 12	Activate R-S 485
rS1 13	Not documented

12.1 Baud rate (function "rS1 01")

⇒ Call up function "rS1 01", see chapter 12.



⇒ Press the TARE-key, current setting appears.

⇒ Select desired settings with TARE or UNIT key.

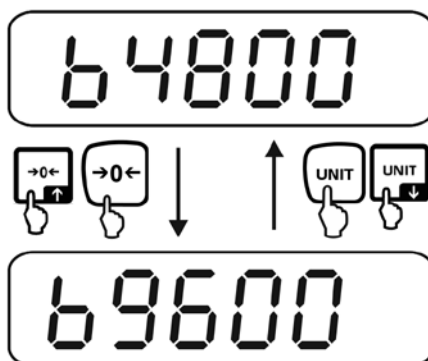

b600	You can select 600/1200/2400/4800/9600 (bit/ second)
↓	
b19200	

⇒ Confirm with the TARE key, the display returns back to the menu.

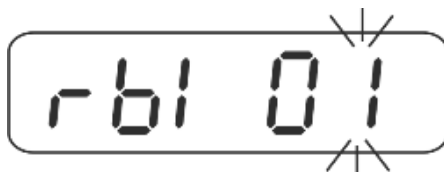

⇒ To go back into the weighing mode see chapter 12.

12.2 Parity (function "rS1 02")

⇒ Call up function "rS1 01", see chapter 12.

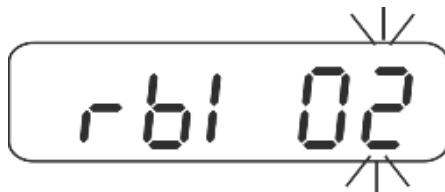

⇒ Press the TARE-key, current setting appears.

⇒ Select desired settings with TARE or UNIT key.

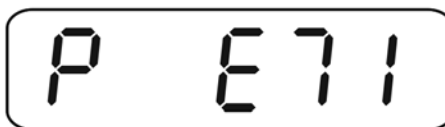
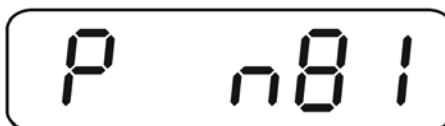
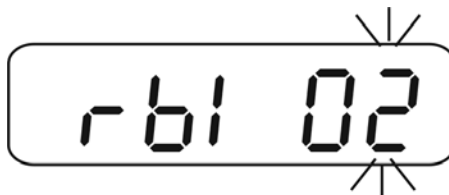

P n81	No parity, 8 bits, 1 stop bit
P E71	Even parity 7 bits, 1 stop bit
P o71	Odd parity, 7 bits, 1 stop bit

⇒ Confirm with the TARE key, the display returns back to the menu.

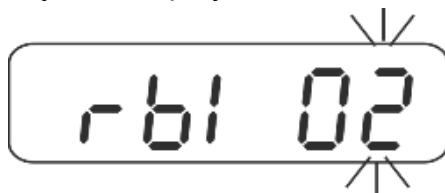

⇒ To go back into the weighing mode see chapter 12.

12.3 Output format (function "rS1 03")

⇒ Call up function "rS1 01", see chapter 12.

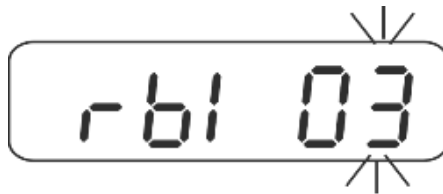

⇒ Press the TARE-key, current setting appears.

⇒ Select desired settings with TARE or UNIT key.

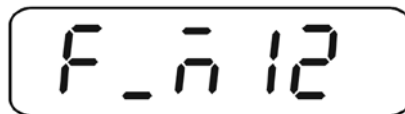
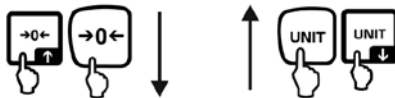
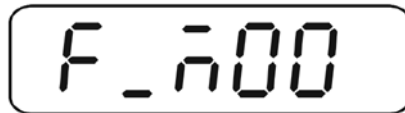
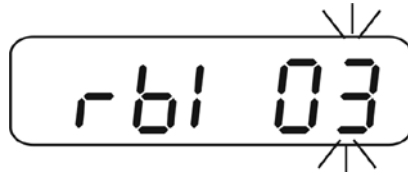

F_M 00 Factory settings	Display value with status Sample printout:
	ST, G + 1.000 kg
F_M 01	Gross weight with status
F_M 02	Net weight with status
F_M 03	Display value without status sample printout:
	+ 1.000
F_M 04	Gross weight without status
F_M 05	Net weight without status

F_M 06	Hi /Lo/ OK status + display value without status sample printout:	
	Lo (001)	001+ 2.000
	OK (010)	010+ 3.000
	Hi (100)	100+ 4.000
F_M 07	Hi /Lo/ OK status + gross weight without status	
F_M 08	Hi/ Lo/ Ok status + net weight without status	
F_M 09	Tare weight	
F_M 10	M+ accumulation mode 1, sample printout see chapter 8.2 Total = sum of net weight of each weight reading	
F_M 11	M+ accumulation mode 2, sample printout see chapter 8.2 Total = Sum of gross weight of each weight reading	

⇒ Confirm with the TARE key, the display returns back to the menu.

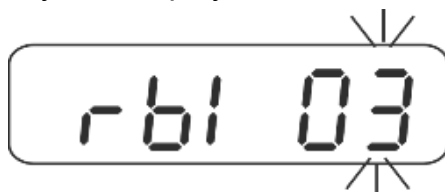

⇒ To go back into the weighing mode see chapter 12.

Symbols:

ST	Stable value
US	Instable value
G	Gross weight
N	Net weight
T	Tare weight
TICKET NO	Number of weight readings „Accumulation“
TOTAL	Total of all individual weighings

12.4 Output format (function „rS1 04“)

⇒ Call up function "rS1 04", see chapter 12.

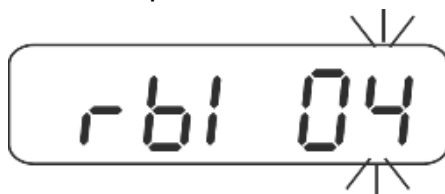

⇒ Press the TARE-key, current setting appears.

⇒ Select desired settings with TARE or UNIT key.

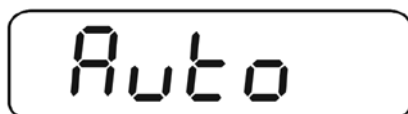
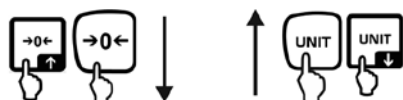
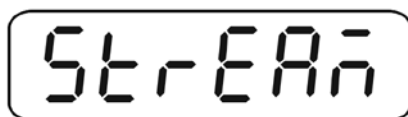
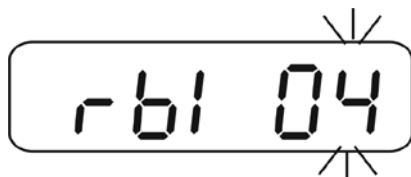

Comand	Data output via remote control commands
Stream	Continuous output
Auto	Automatic issue of first stable weighing value Sequence of operations: 1. Place weight, issue of first stable weighing value 2. Renewed output only possible after weight was removed. 3. Place next weight.
rS-off	Interface deactivated
M_Plus	Add-up mode

⇒ Confirm with the TARE key, the display returns back to the menu.

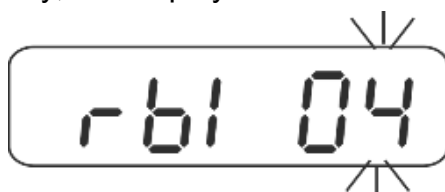

⇒ To go back into the weighing mode see chapter 12.

12.5 Continuous output rate (function „rS1 05“)

⇒ Call up function "rS1 05", see chapter 12.

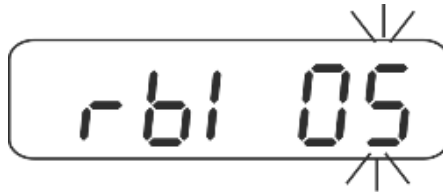

⇒ Press the TARE-key, current setting appears.

⇒ Select desired settings with TARE or UNIT key.

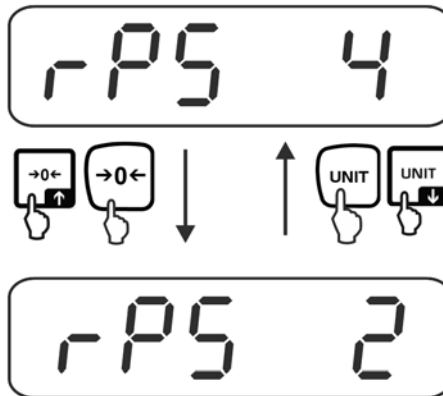

rPS 1 ↓ rPS 16	Data transmission rate 1, 2, 4, 8, 16 times/ second Factory setting rPS 4
MAII	Data transmission rate >16 times/ second

⇒ Confirm with the TARE key, the display returns back to the menu.

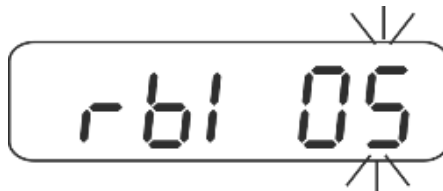

⇒ To go back into the weighing mode see chapter 12.

12.6 Automatic data output with zero display (function "rS1 06")

⇒ Call up function "rS1 06", see chapter 12.



⇒ Press the TARE-key, current setting appears.

⇒ Select desired settings with TARE or UNIT key.

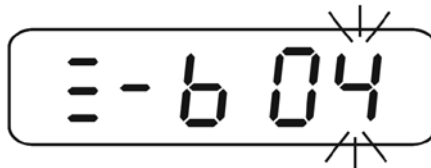
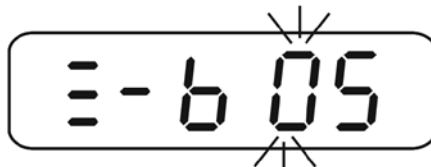
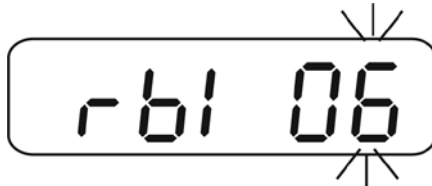

-b 00 ↓ -b 99	Range, below which appliance has to go before the scale prints, you can select 0 - 99 division steps. Factory setting "- b05".
-----------------------------------	---

⇒ Confirm with the TARE key, the display returns back to the menu.



⇒ To go back into the weighing mode see chapter 12.

12.7 Condition for data output (function "rS1 08")

⇒ Call up function "rS1 08", see chapter 12.



⇒ Press the TARE-key, current setting appears.

⇒ Select desired settings with TARE or UNIT key.

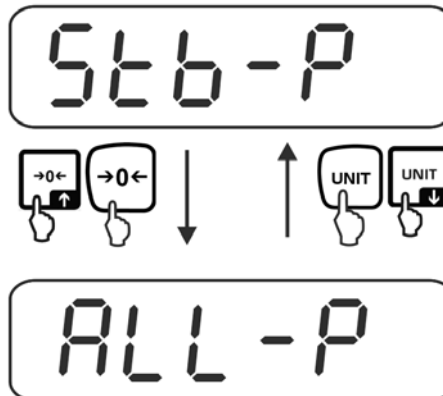

Stb-P Factory setting	Output only with stable weight values (no output with unstable weight values and "OL „)
StoL-p	Output only for stable weight values (including „OL“)
ALL-P	Output of all weight values

⇒ Confirm with the TARE key, the display returns back to the menu.

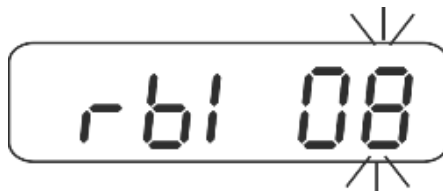

⇒ To go back into the weighing mode see chapter 12.

12.8 6/ 7-digit data format (function "rS1 09")

⇒ Call up function "rS1 09", see chapter 12.



- ⇒ Press the TARE-key, current setting appears.
- ⇒ Select desired settings with TARE or UNIT key.

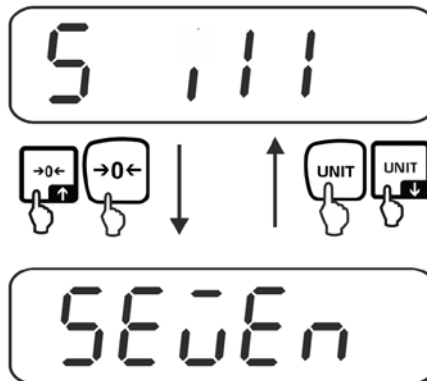

S ill Factory setting	6 Digits
SEvEn	7 Digits

⇒ Confirm with the TARE key, the display returns back to the menu.

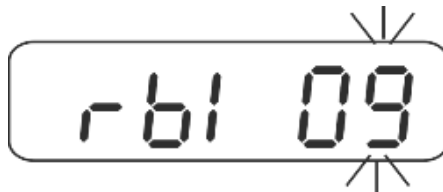

⇒ To go back into the weighing mode see chapter 12.

12.9 Set the date/ time (function "rS1 10")

⇒ Call up function "rS1 09", see chapter 12.

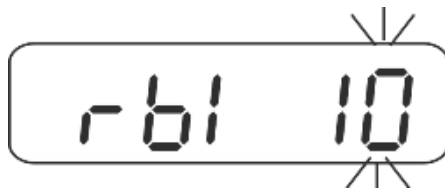

⇒ Press the TARE-key, current setting appears.

⇒ Set the date with TARE or UNIT key.

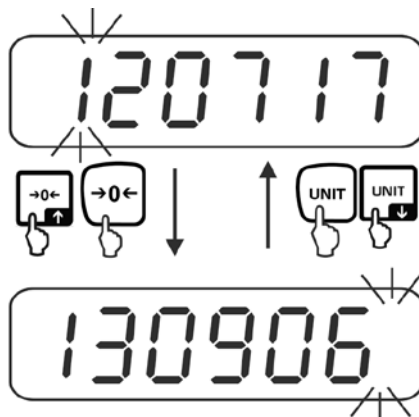

⇒ Press the TARE key repeatedly until the last digit flashes, the display for the time setting appears.

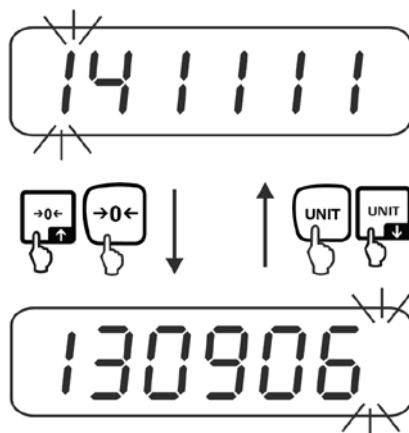

⇒ Press the TARE key repeatedly until the last light flashes, the display returns back to the menu.

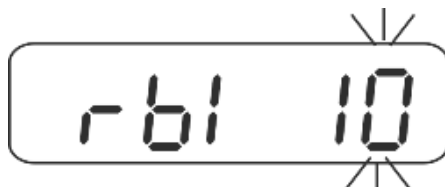

⇒ To go back into the weighing mode see chapter 12.

- ⇒ Set the date format (function "rS1 11")
- ⇒ Call up function "rS1 11", see chapter 12.

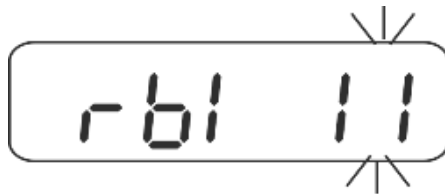

- ⇒ Press the TARE-key, current setting appears.
- ⇒ Select desired settings with TARE or UNIT key.

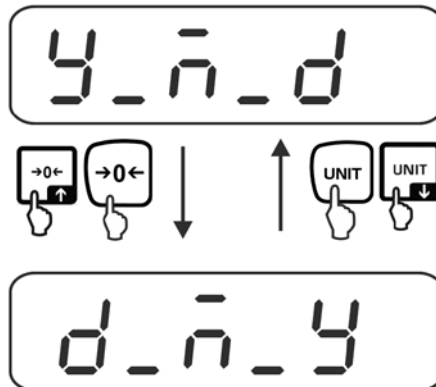

y_m_d	Year/ month/ day
d_m_j	Day/Month/Year

- ⇒ Confirm with the TARE key, the display returns back to the menu.

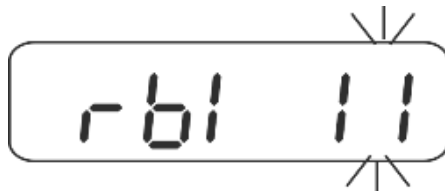

- ⇒ To go back into the weighing mode see chapter 12.

- ⇒ RS 485 ID input (function "rS1 12")
- ⇒ Call up function "rS1 12", see chapter 12.

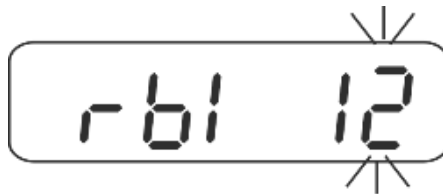

- ⇒ Press the TARE-key, current setting appears.
- ⇒ Select desired settings with TARE or UNIT key.

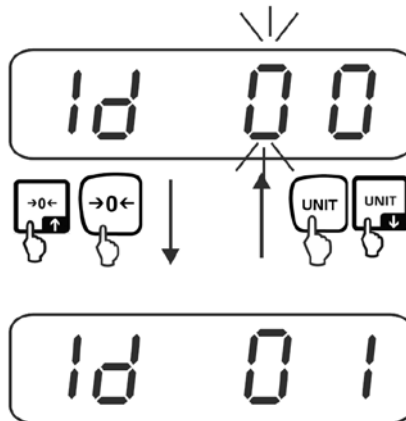

ld 00 ↓ ld 99	ID input, you can select 0 - 99 With the input „ID 00“ the remote control instructions are the same as with RS232, see chapter 13
-----------------------------------	--

- ⇒ Confirm with the TARE key, the display returns back to the menu.

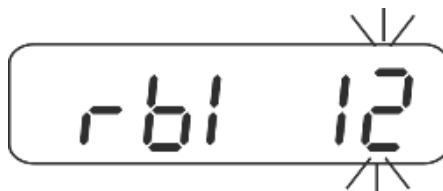

- ⇒ To go back into the weighing mode see chapter 12.

13 Instruction mode

RS 485:

- ⇒ During input „Id 00“(function RS1 12, see chapter 12.12) the instruction format is the same as with RS232.
- ⇒ During input "ID 01-99" "@ID „must be placed in front of the remote control command, so that the respective scale reacts to the instruction; e. g. to set the scale to zero with ID 99 the instruction must be sent to "@99MZ“ followed by the control characters <CR><LF>.

Orders:

MZ	Zeroing
MT	Taring
MG	Display gross weight
MN	Indicate net weight
CT	Delete tare
SC	Continuous data output
SA	Automatic data output
SO	Instruction mode
%	Stop continuous data output and start instruction mode.
UA*	Switch over to the first weighing unit.
UB*	Switch over to the second weighing unit*
UC*	Switch over to the third weighing unit*
UD*	Switch over to the forth weighing unit*
UE*	Switch over to the fifth weighing unit*
UF*	Switch over to the sixth weighing unit*
RW	Send current weight value
RG	Send gross weight
RN	Send net weight
RT	Send tare weight
RB	Send the display value without status
RH	Send gross weight without status
RI	Send net weight without status

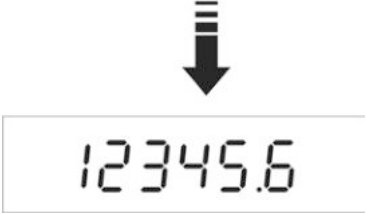
RJ	Hi /Lo/ OK status + display value without status Example:									
	Hi/ Lo/ OK status			Sample display						
	Lo (001)			001+ 2.000						
	OK (010)			010+ 3.000						
Hi (100)			100+ 4.000							
RK	Hi/Lo/ OK status + gross weight without status (example see "RJ").									
RL	Rear one/ Lo/ OK status + net weight without status (example see "RJ").									
RS	Show tolerance limit RS□□□□ □□: Class (00 ~ 99) * □□ : LO or HI									
	HI	Display of the adjusted upper limit value								
	LO	Display adjusted lower limit value								
Example: Command RS02LO<CR><LF> Response RS02LOXXXXXX<CR><LF>										
WS	Set tolerance limit WS□□□□ XXXXXX □□: Class (00 ~ 99) * □□ : LO or HI XXXXXX: Enter the limit value									
	HI	Enter the value for the upper limit								
	LO	Enter the value for the lower limit								
Example: Command WS00HI001000<CR><LF> Response WS00HI001000<CR><LF>										
#####	Example:									
		Value				Position decimal point	CR	LF		
		1	2	3	4	5	6	1		
										
Display										

i	<p>*dependent on model</p> <p>Should it be sent continuously, the command must be preceded by %.</p> <p>If stable weight values are to be sent, the command must be preceded by #.</p>
----------	--

14 Data output format

14.1 7-digit data format (first decimal place not included)

Weight value with status

Gross	S	T	,	G	S	,	+	0	1	2	3	4	5	6	7	SP	SP	o	z	CR	LF
Net	S	T	,	N	T	,	+	1	.	2	3	.	4	5	6	t	l	.	g		
Tare	S	T	,	T	R	,	+	0	1	2	.	3	4	5	6	SP	SP	k	g		
Plus OL	O	L	,	G	S	,	+	SP	SP	SP	SP	SP	SP	SP	SP	SP	SP	SP	SP		
Minus OL	O	L	,	G	S	,	-	SP	SP	SP	SP	SP	SP	SP	SP	SP	SP	SP	SP		
Unstable	U	S	,	G	S	,	+	0	1	2	3	4	.	5	6	SP	SP	l	b		

Weight value without status

G / N	+	1	.	2	3	.	4	5	6	CR	LF
G / N	+	0	1	2	3	4	5	.	6		
G / N	+	0	1	2	.	3	4	5	6		
Plus OL	+	SP	SP	SP	SP	SP	SP	SP	SP		
Minus OL	-	SP	SP	SP	SP	SP	SP	SP	SP		

Hi /Lo/ OK status + display value without status:

Byte0	Byte1	Byte2	+/-	1	.	2	3	.	4	5	6	CR	LF
-------	-------	-------	-----	---	---	---	---	---	---	---	---	----	----

Byte0: HI 30H / 31H

Byte1: OK 30H / 31H

Byte2: Lo 30H / 31H

14.2 6-digit data format (first decimal place not included)

Weight value with status

Gross	S	T	,	G	S	,	+	1	2	3	4	5	6	7	SP	SP	o	z	CR	LF
Net	S	T	,	N	T	,	+	.	2	3	.	4	5	6	t	l	.	g		
Tare	S	T	,	T	R	,	+	1	2	.	3	4	5	6	SP	SP	k	g		
Plus OL	O	L	,	G	S	,	+	SP	SP	SP	SP	SP	SP	SP	SP	SP	SP	SP		
Minus OL	O	L	,	G	S	,	-	SP	SP	SP	SP	SP	SP	SP	SP	SP	SP	SP		
Unstable	U	S	,	G	S	,	+	1	2	3	4	.	5	6	SP	SP	l	b		

Weight value without status

G / N	+	.	2	3	.	4	5	6	CR	LF
G / N	+	1	2	3	4	5	.	6		
G / N	+	1	2	.	3	4	5	6		
Plus OL	+	SP	SP	SP	SP	SP	SP	SP		
Minus OL	-	SP	SP	SP	SP	SP	SP	SP		

Hi /Lo/ OK status + display value without status:

Byte0	Byte1	Byte2	+/-	.	2	3	.	4	5	6	CR	LF
-------	-------	-------	-----	---	---	---	---	---	---	---	----	----

Byte0: HI 30H / 31H

Byte1: OK 30H / 31H

Byte2: Lo 30H / 31H

15 Bluetooth (Factory option)

- Click in the task border  with activated Bluetooth.



- ⇒ Click on „Add device“.

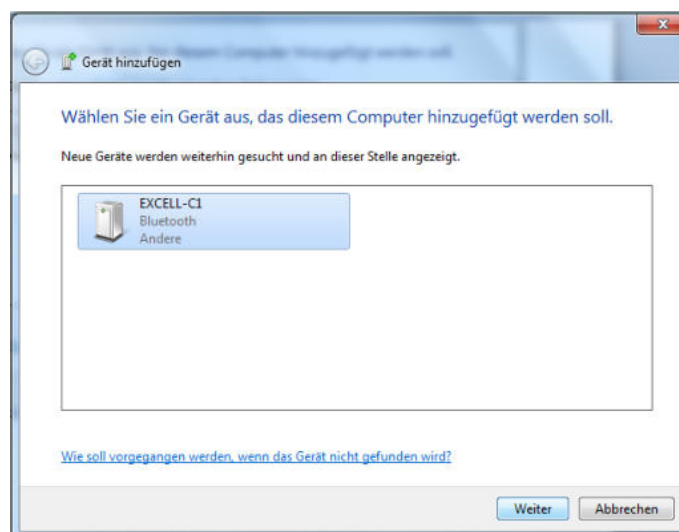
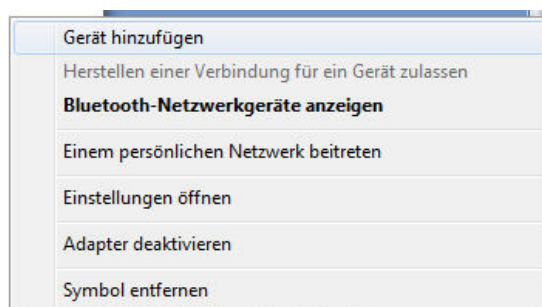

⇒ Click on "Enter pairing code of the device"

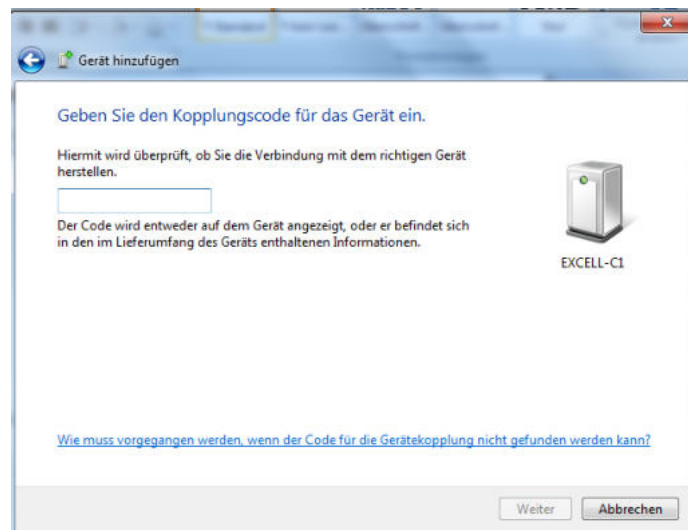
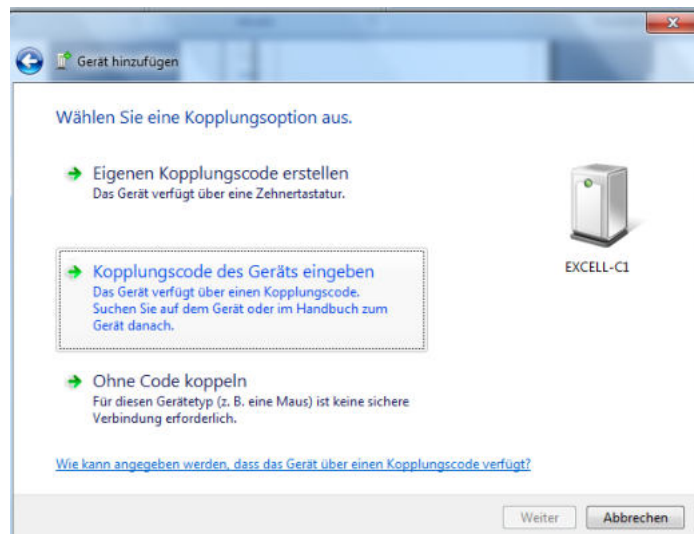

⇒ Enter code 1111

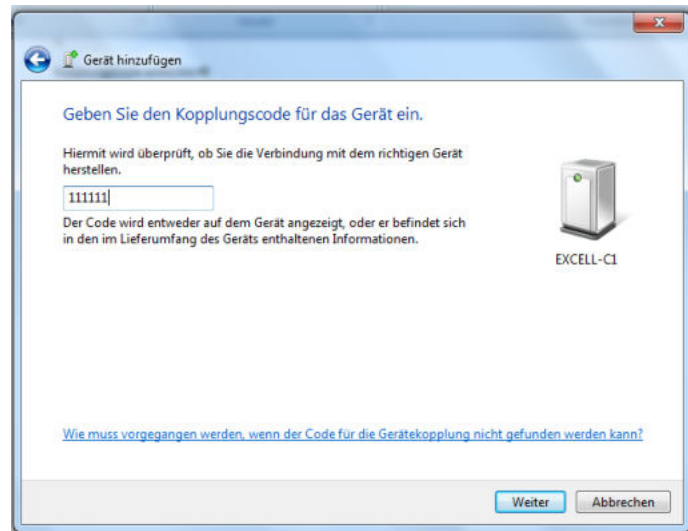

⇒ Click on „Next“

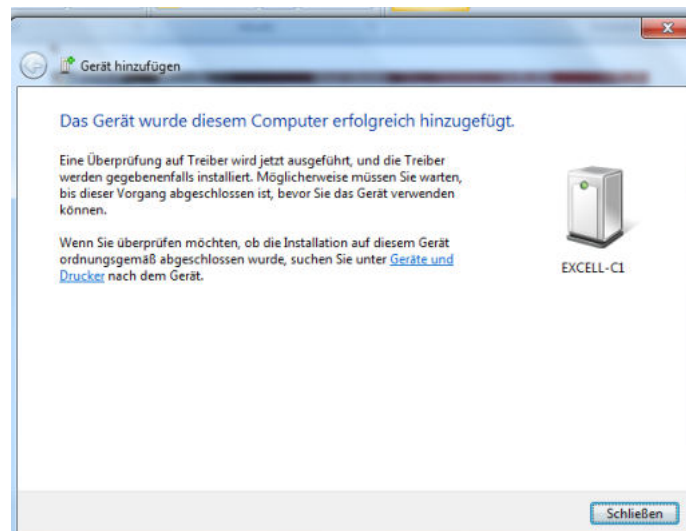

⇒ Click on „Close“

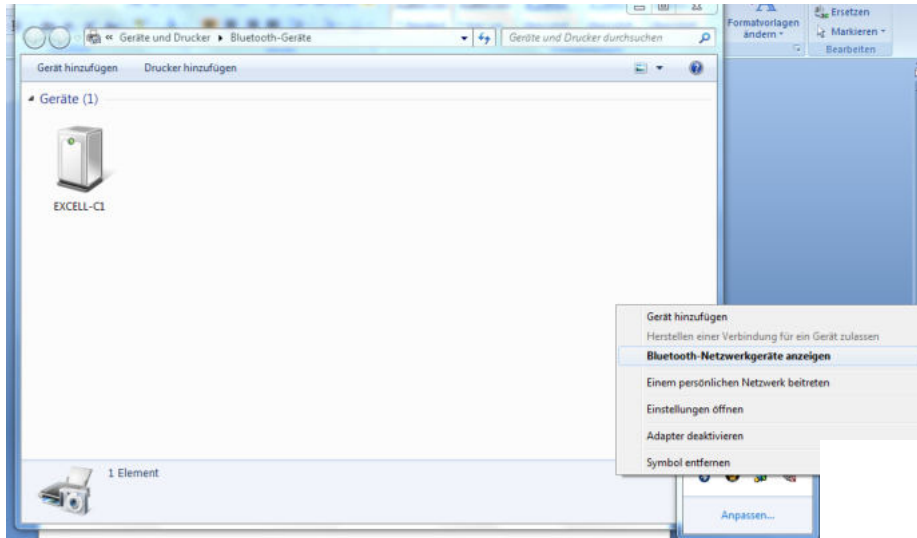

⇒ Display Bluetooth network appliance

English

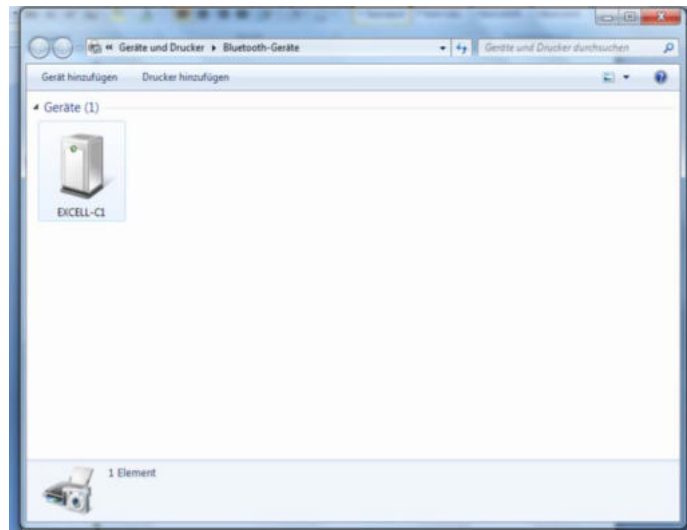

⇒ Double click

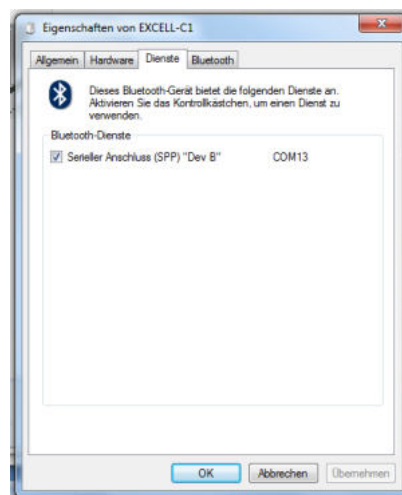

16 Servicing, maintenance, disposal



Before any maintenance, cleaning and repair work disconnect the appliance from the operating voltage.

16.1 Clean

- ⇒ Keep IP protection.
- ⇒ Clean the stainless-steel parts with a soft cloth soaked with a cleaning agent suitable for stainless steel.
- ⇒ For stainless steel parts do not use any cleaning agents which contain sodium hydroxide solution, acetic, hydrochloric, sulphuric or citric acid.
- ⇒ Do not use metal brushes or cleaning sponges of steel wool, as this causes superficial corrosion.

16.2 Servicing, maintenance

- ⇒ The appliance may only be opened by trained service technicians who are authorized by KERN.
- ⇒ Ensure that the balance is regularly calibrated, see chap. Monitoring of test resources.

16.3 Disposal

- ⇒ Disposal of packaging and appliance must be carried out by operator according to valid national or regional law of the location where the appliance is used.

16.4 Error messages

Error message	Description
E 0	EEPROM error value outside of A/ D transducer range
E 1	Zero points above the zero adjusting range
E 2	Zero points below zero adjusting range
E 4	A/D converter
oL	Overload
-oL	Underload
oF	Internal value < zero range

Should other error messages occur, switch balance off and then on again. If the error message remains inform manufacturer.

17 Instant help

In case of an error in the program process, briefly turn off the display unit and disconnect from power supply. The weighing process must then be restarted from the beginning.

Help:

Fault

Possible cause

The displayed weight does not glow.

- The display unit is not switched on.
- Mains power supply interrupted (mains cable defective).
- Power supply interrupted.
- (Rechargeable) batteries are inserted incorrectly or empty
- No (rechargeable) batteries inserted.

The displayed weight is permanently changing

- Draught/air movement
- Table/floor vibrations
- Weighing pan has contact with other objects.
- Electromagnetic fields / static charging (choose different location/switch off interfering device if possible)

The weighing result is obviously incorrect

- The display of the balance is not at zero
- Adjustment is no longer correct.
- Great fluctuations in temperature.
- Warm-up time was ignored.
- Electromagnetic fields / static charging (choose different location/switch off interfering device if possible)

18 Installation display appliance/ load cell

- i** Installation / configuration of the weighing system must be carried out by a well acquainted specialist with the workings of weighing balances.

18.1 Weighing system design

The display unit is suitable for connection to any analogue platform in compliance with the required specifications.

The following data must be established before selecting a weighing cell:

- **Weighing balance capacity**
This usually corresponds to the heaviest load to be weighed.
- **Preload**
This corresponds to the total weight of all parts that are to be placed on the weighing cell such as upper part of platform, weighing pan etc.
- **Total zero setting range**
This is composed of the start-up zero setting range and the zero setting range available to the user via the ZERO-key.
The addition of weighing scales capacity, preload and the total zero setting range give the required capacity for the weighing cell.
To avoid overloading of the weighing cell, include an additional safety margin.
- **Smallest desired display division**
- **Verification ability, if necessary**
menu setting CFn 02 = 1, see chapter 19.5.2

18.2 Attach the load cell

- ⇒ Disconnect the display unit from the power supply.
- ⇒ Attach the load cell cables according to the following illustration.

4-wire load cells:



When using 4-wire load cells SEN + and SEN - must not be connected.

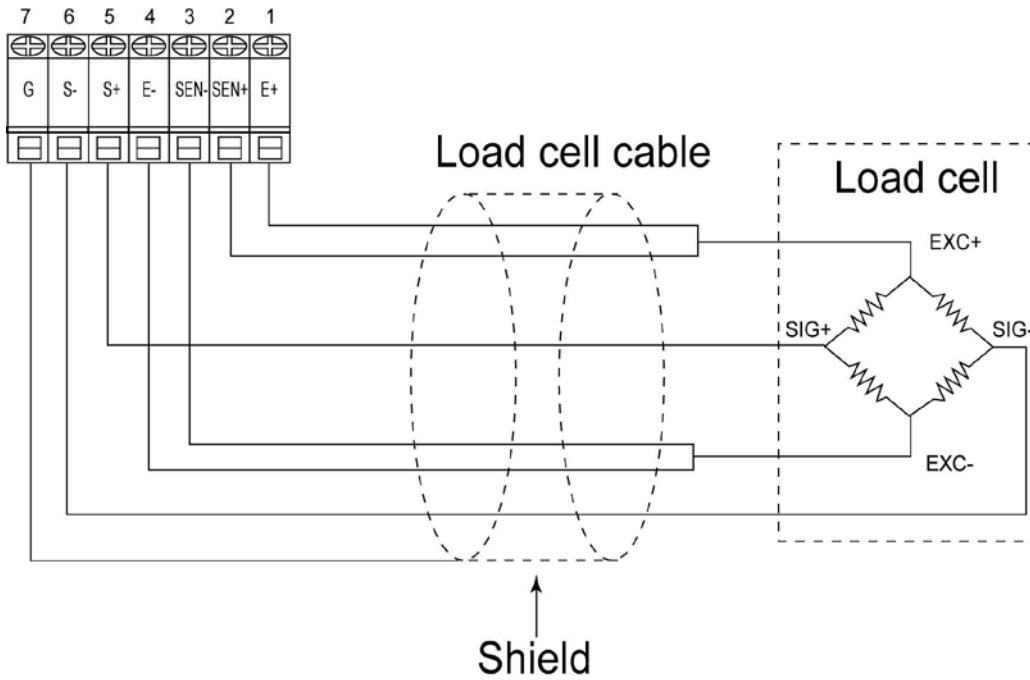

6-wire load cells:

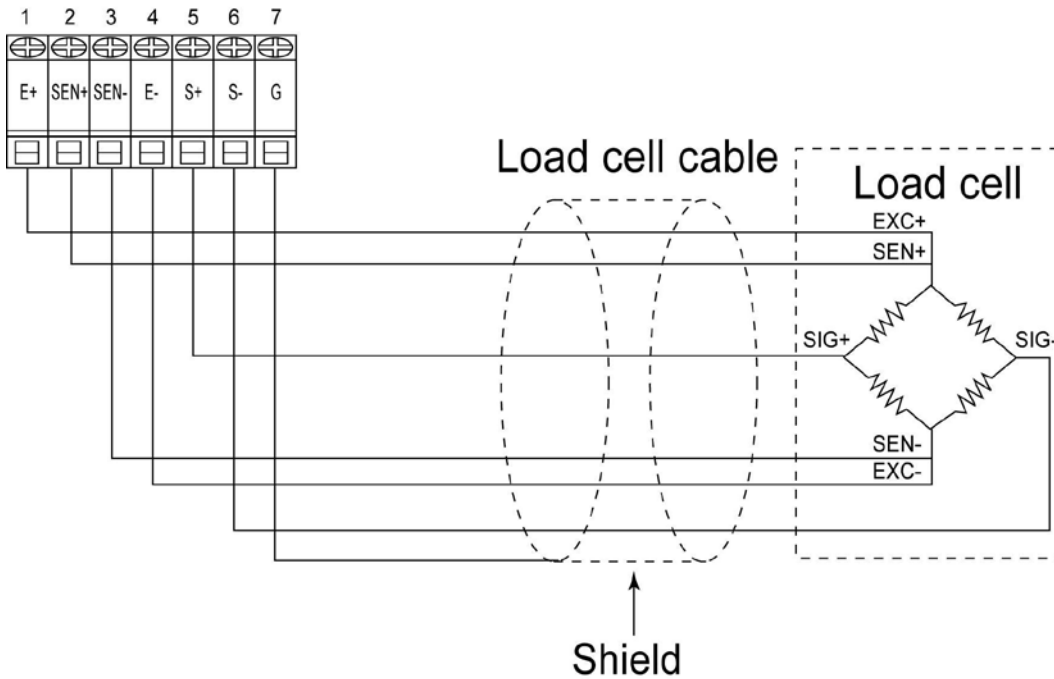

18.3 Attach RS232

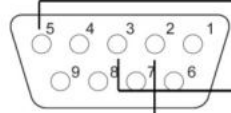
PC	PIN	Function	Female 9 PINS		PIN	Function
	2	Transmit Data	←		1	SG
	3	Receive Data	→		2	TxD
	5	Signal Ground	↔		3	RxD

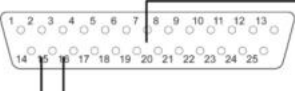
Printer	PIN	Function	Male 25 PINS		PIN	Function
	2	Receive Data	←		1	SG
	3	Transmit Data	→		2	TxD
	7	Signal Ground	↔		3	RxD

19 Service menu

Verified weighing systems:

- In verified weighing systems the access to the service menu is locked. In order to unlock the access, the sealing must be destroyed (see chapter 6.9) and the housing opened. On the plate move the adjusting switch **SWA1** to position „**ADJ**“. Switch on equipment, **01 C5P** is indicated.

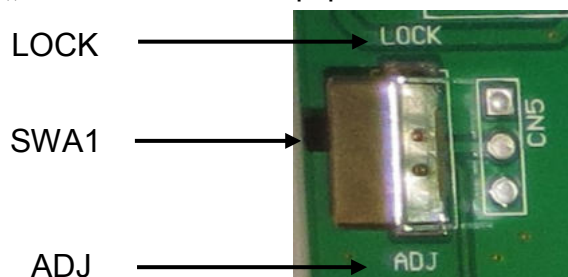

- After the configuration, the access to the service menu must be locked again. Also move the adjusting switch to the position „**LOCK**“. At the same time it leaves the service mode, the appliance returns to the weighing mode.
- Attention:
After destruction of the sealing the weighing system must be re-verified by an authorised agency and a new sealing fitted before it can be reused for applications subject to verification.

Unverified weighing systems

- ⇒ With unverified weighing systems the housing does not have to be opened, the access to the service menu is protected only by a password ("002011", not changeable).
- ⇒ Use the on/off key to switch on an appliance with pressed UNIT key.

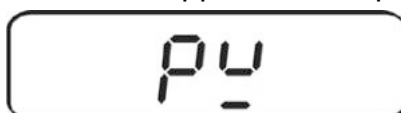

- ⇒ Press TARE button, „-----“ is displayed.

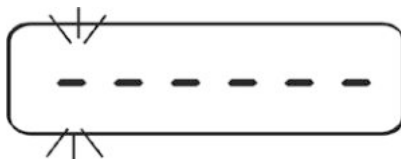

- ⇒ With the navigation keys (see chapter 2.1.1) Enter password "002011". At incorrect input the scale completes a self check and returns back into the weighing mode.



- ⇒ Confirm with TARE key. The first menu block **01 C5P** is displayed.
- ⇒ With the navigation keys (see chapter 2.1.1) select desired menu block.
- ⇒ To exit the menu **01 C5P** / return to the weighing mode, switch device off and on again with the ON/ OFF key.

The service menu consists of the following blocks:

01 C ₅ P	Configure the weighing system, see chapter 19.1
02 CAL	Adjustment of verified weighing systems, see chapter 19.3
03 CL _n	For linearisation see chapter 19.2
04 CF _n	Appliance settings of verified weighing systems, see chapter 19.5
06 CG _r	Alter the gravitation zone, see chapter 19.4

Navigation:

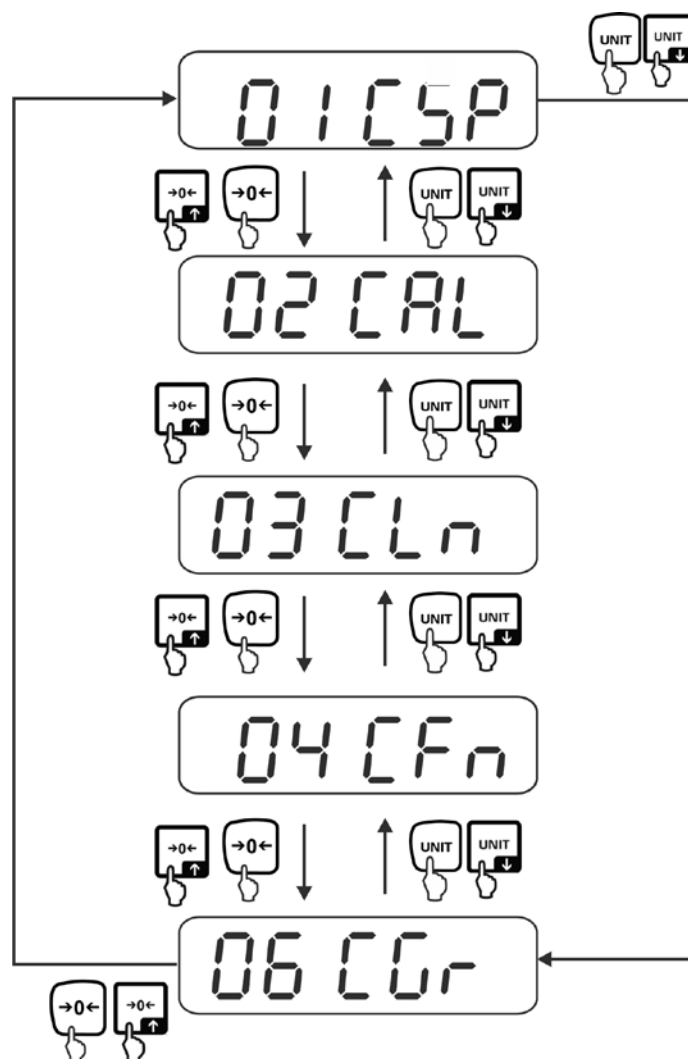

19.1 Configure weighing system / menu block 01 CSP

⇒ Call up the menu block 01 CSP, see chapter 19.

Call up the navigation in the menu/ function:

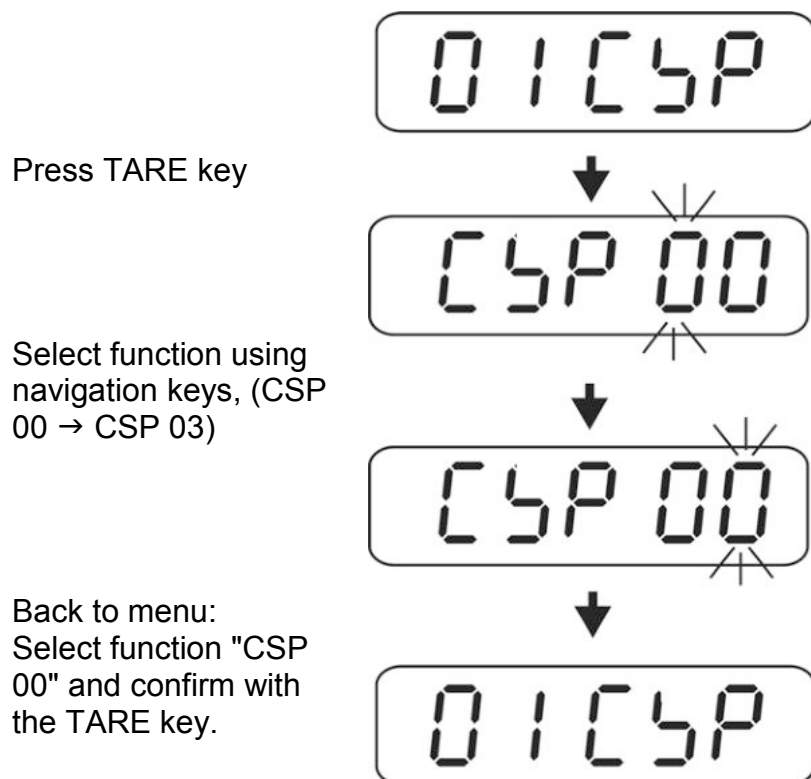

Overview:

CSP 00	Exit menu
CSP 01	Unverified weighing systems, see chapter 18.1.1
CSP 02	For verified weighing systems see chapter 18.1.2
CSP 03	Type of scale, see chapter 19.1.3

19.1.1 Unverified weighing systems (function „CSP 01”)



Menu setting „unverified” CFN 02 = 0, see chapters. 19.5.2.

⇒ Call up function "CSP 01", see chapter 19.1 "Navigation in the menu“.

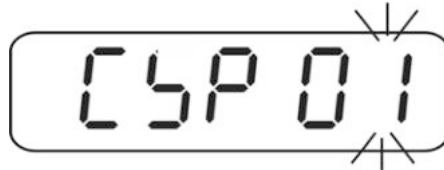

⇒ Press the TARE key, the current set capacity / resolution is displayed for 2 seconds (display sample Max 15 kg / d 0.01 kg), followed by the display of "u00000" to adjust the weighing units.

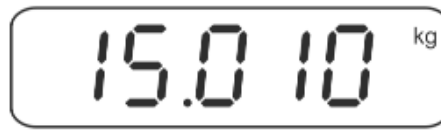

Settings of weighing units:



Description

- (a) ⇒ Standard weighing unit, only "kg", "g", or "lb", can be selected (parameters 0, 1 or 2)
- (b) ⇒ Second weighing unit, in which can be toggled with the UNIT key.
- (c) ⇒ Third weighing unit, in which can be toggled with the UNIT key
- (d) ⇒ Forth weighing unit, in which can be toggled with the UNIT key
- (e) ⇒ Fifth weighing unit, in which can be toggled with the UNIT key
- (f) ⇒ Number of weighing units in which can be toggled with the UNIT key

Parameters	1	2	3	4	5	6	7	8
Unit	kg	g	lb	Not documented	oz	GN	dwt	ct
Symbol	kg	g	lb		▼ ⁷	▼ ⁶	▼ ⁶	▼ ⁶
					Indicators ▼, see ch. 2.3			

Parameter:			
(0) ⇒	kg	(5) ⇒	Oz
(1) ⇒	g	(6) ⇒	GN
(2) ⇒	lb	(7) ⇒	dwt
(4) ⇒	Not documented	(k) ⇒	ct

⇒ Use the navigation buttons to select desired settings



Example 020002:

Standard weighing unit "kg" (a), second weighing unit "lb" (b), number of weighing units "2" (f)

⇒ Confirm with TARE key, the display "C00000" appears on the input capacity (max).



Example 015000 ⇒ 15.000kg

⇒ With the navigation keys (see chapter 2.1.1) enter the desired capacity.
Examples:

Max.	Input
15.000 kg	015000
1500.0 g	015000
6.000 lb	006000

⇒ Press the TARE key repeatedly until the display "d00000" appears for the input of "resolution (d), decimal places and type of scale".



⇒ With the navigation keys (see chapter 2.1.1) select desired settings.

Settings:

(m)(n)(o)(p)(q)

Description

- (m) ⇒ Readability (d), select from 1, 2, or 5 steps
- (n) ⇒ Number of decimal places, select from 0 ~ 5

Examples:

Adjustment	
3	15.000 kg
1	1500.0 g
3	6.000 lb

- (o) ⇒ 0, 1 ⇒ Single-range balance
- 2 ⇒ Divide into maximum of two sections (subranges 1/2 max)
- 3 ⇒ Divide into maximum of three sections (subranges 1/6 and 2/3 max)
- (p) ⇒ 0 ⇒ Multi-interval balance
- 1 ⇒ Multi-range balance

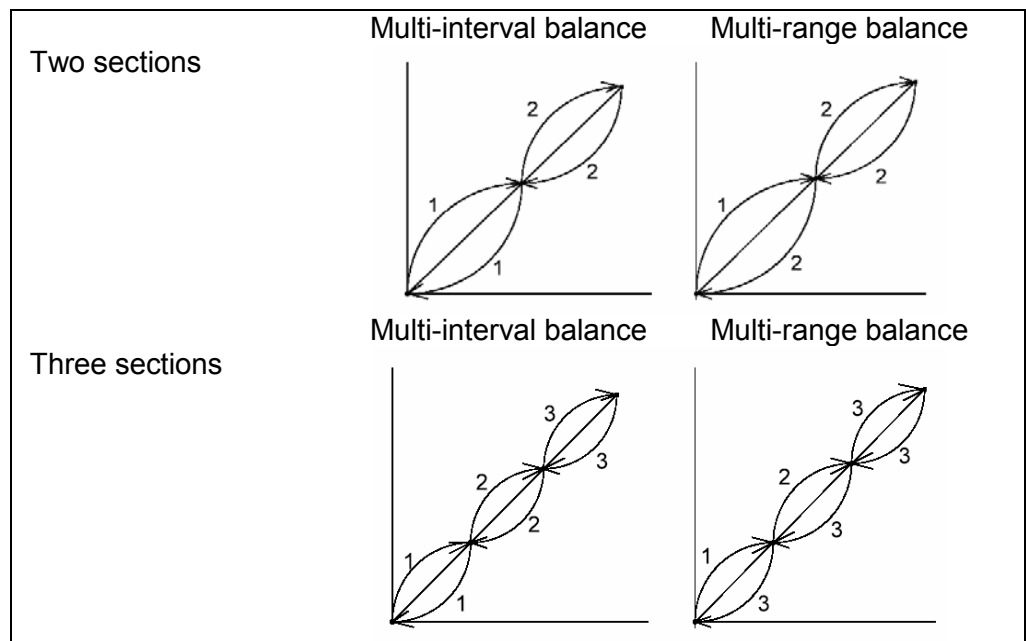

- (q) ⇒ Not documented
- (0) ⇒ Factory setting



Example 132000:

1	⇒	Readability 1 step
3	⇒	3 decimal places
2	⇒	Divide into maximum of two sections
0	⇒	Multi-interval balance
0	⇒	Division multiplication factor

⇒ Press the TARE key, the newly set capacity / resolution is displayed for 2 seconds (display sample maximum 15 kg / d 0.001 kg). The display automatically returns back to the menu.

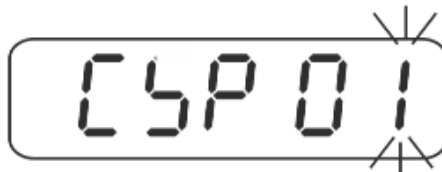

⇒ With the navigation keys (see chapter 2.1.1) select "CSP 00".

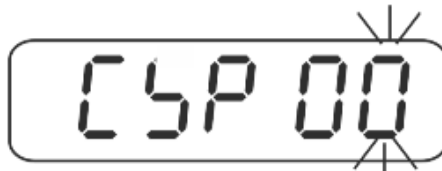

⇒ Confirm with TARE key.

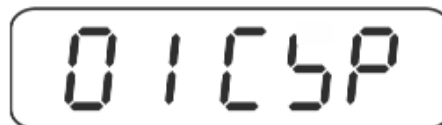

⇒ To exit the menu / return to the weighing mode, switch off and on again with the ON/ OFF key.

⇒ Use the navigation buttons to select desired settings

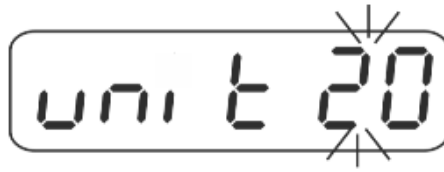

Example unit 20:

Number of balancing units "2" (a), standard weighing unit „kg“(b),

⇒ Confirm with TARE key, the current standard weighing unit is indicated for 2 seconds (e.g. „kg“) followed by the display „000001“ for adjustment to the capacity (max.).

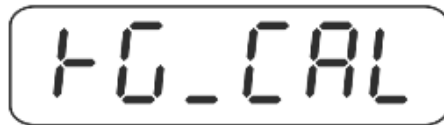

Settings maximum:



Description

(c) ⇒ Standard weighing unit

(d-h) ⇒ Capacity (max)

(i-n) ⇒ Weight value of adjusting weight

⇒ With the navigation keys (see chapter 2.1.1) enter the desired capacity.



Example 015000 ⇒ 15.000kg

⇒ Confirm with TARE key, the display "000002" appears for the input of the weight value for adjusting weight.



⇒ Enter the desired weight value with the navigation keys.



Example 015000 ⇒ 15.000kg

⇒ Confirm with the TARE key, the display "000003" appears for the input of "resolution (d), decimal places and type of scale".



Settings:

000003
(o) (p) (q) (r) (s) (t)

Description

- (o) ⇒ Readability (d), select from 1, 2, or 5 steps
- (p) ⇒ Number of decimal places, select from 0 ~ 5
 - 0 ⇒ 0
 - 1 ⇒ 0.0
 - 2 ⇒ 0.00
 - 3 ⇒ 0.000
 - 4 ⇒ 0.0000
 - 5 ⇒ 0.00000
- (q) ⇒ 0 Standard weighing unit
Always use setting of "0".
- (r) ⇒ 0, 1 ⇒ Single-range balance
 - 2 ⇒ Divide into maximum of two sections (subranges 1/2 max)
 - 3 ⇒ Divide into maximum of three sections (subranges 1/6 and 2/3 max)
- (s) ⇒ 1 Order of weighing units in which can be toggled using the UNIT key.
Always use setting of "1".
- (t) ⇒ 0 ⇒ Multi-interval balance
 - 1 ⇒ Multi-range balance

⇒ Enter the desired parameters with the navigation keys.



Example 530010:

5	⇒	Readability of 5 steps
3	⇒	3 decimal places $d = 0.005$
0	⇒	Standard weighing unit „kg“
0	⇒	Single-range balance
1	⇒	Sequence of the weighing units
0	⇒	Multi-interval balance

- ⇒ Press the TARE key, the newly set capacity / resolution is displayed for 2 seconds (display sample maximum 15 kg / d 0.005kg). The display automatically returns back to the menu.



15.005^{kg}

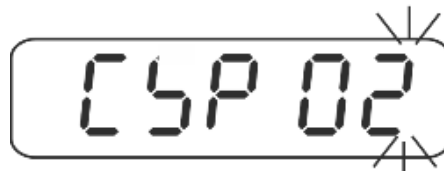

CSP 02

- ⇒ Select „CSP 00“ with the navigation keys.

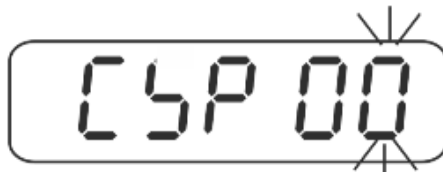

CSP 00

- ⇒ Confirm with TARE key.

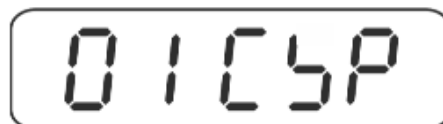

01 CSP

Exit menu / jumping back to weighing mode:

- ⇒ Move the adjusting switch to the position „LOCK“, see chapter 19.



After the configuration linearize and/or adjust the weighing system.

19.1.3 Set the buffeting point (function „CSP 03“)

i With the functions „CSP 01” and „CSP 02” the weighing range, by default, can be divided into:

- Single-range balance
- Divide into maximum of two sections (subranges $\frac{1}{2}$ max)
- Divide into maximum of three sections (subranges $\frac{1}{6}$ and $\frac{2}{3}$ max)

Call up function „CSP 03” to amend the buffeting point.

⇒ Call up function „CSP 03”, see chapter 19.1 "Navigation in the menu".

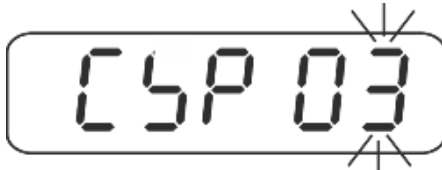

⇒ Press the TARE key, the display shows "unit 0" to enter the weighing unit.

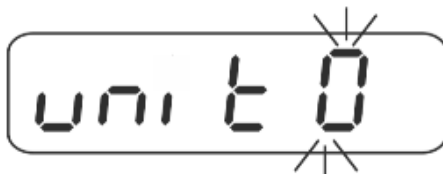

⇒ With the navigation keys (see chapter 2.1.1) enter desired unit, see chapter 19.1.1 and/or 19.1.2.

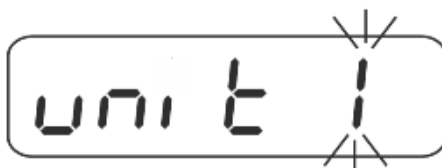

⇒ Confirm with the TARE key, the current set buffeting point is displayed.

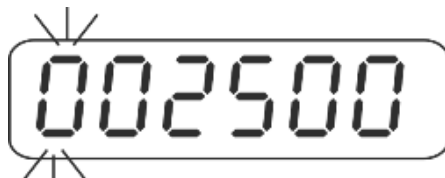

⇒ With the navigation keys (see chapter 2.1.1) select the desired setting.



- ⇒ Confirm with the TARE key, the current set second buffeting point (only during allocation into 3 sections) is indicated.



- ⇒ Use the navigation keys to select the desired settings



- ⇒ Confirm with the TARE key, the display returns back to the menu.

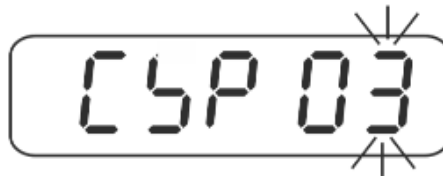

- ⇒ Select „CSP 00“ with the navigation keys.

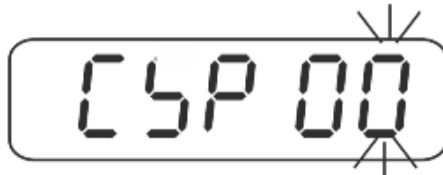

- ⇒ Confirm with TARE key.

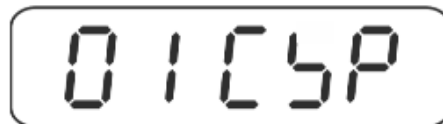

- ⇒ To exit the menu / return back to the weighing mode, see chapter 19.1.1 and/or 19.1.2.

19.2 Linearization/ menu block 03 CLn

Linearity shows the greatest deviation of a weight display on the scale to the value of the respective test weight according to plus and minus over the entire weighing range. If linearity deviation is discovered during a monitoring of test resources, you can improve this by means of linearization.

i

- Carrying out linearization is restricted to specialist staff possessing well acquainted with the workings of weighing scales.
- The test weights to be used must be adapted to the weighing scale's specifications; see chapter "monitoring of test resources".
- Observe stable environmental conditions. Stabilisation requires a certain warm-up time.
- After successful linearisation you will have to carry out calibration; see chapter 3.4 "Monitoring of test resources".

Procedure:

1. Call up function 03 CLn, see chapter 19.

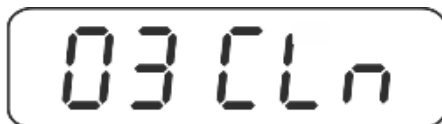

2. Press the TARE key.



Ensure that there are no objects on the weighing pan.

3. Press the TARE key.

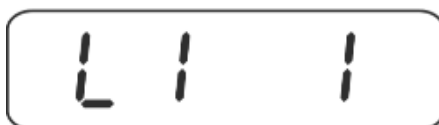

4. With display "L1 1" set the „first adjusting weight carefully into the centre of the weighing plate". With the navigation keys (see chapter 2.1.1) Enter the desired factor, by which the following adjustment weight is to increase. Press the TARE key.

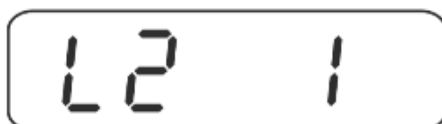

5. With display "L2 1" set the second adjustment weight carefully into the centre of the weighing plate. With the navigation keys (see chapter 2.1.1) Enter the desired factor, by which the following adjustment weight is to increase. Press the TARE key.



- When „L3 1“ is displayed, place the third adjustment weight carefully in the centre of the weighing plate. Enter the desired factor, by which the following adjusting weight is to increase, with the navigation keys.
Press the TARE key.
- Repeat step 6 depending on the number of desired linearization points.
The number of desired points of linearization is completed by pressing the BG/ NET key.



⇒ Confirm with the TARE key, the display returns back to the menu.



⇒ To exit the menu / return back to the weighing mode, see chapter 19.1.1 and/or 19.1.2.

- i** • With the L0, L1 display, the linearization can be cancelled with the BG/ NET key.
- With the L2, L3, L4, L5, L6, L7 or L8 display, the linearization can be cancelled by pressing the BG/ NET key (e.g. L3 corresponds to a 3-point linearization).

Setting "factor"

- 1 = All weight values are equal
- 2 = The following weight value is twice as high as the first.
- 3 = The following weight value is three times higher than the first
- 4 =5 times...
- 5 =6 times...
- 6 =7 times...
- 7 =8 times...
- 8 =9 times...
- A =10 times...
- B =11 times...
- C =12 times...
- D =13 times...
- E =14 times...
- F =15 times...

Examples:

Example 1: 4-point linearization/ 30 kg (10 kg, 10 kg, 10 kg)

Display	Button	Explication
03 CLn	TARE	Linearization function
L0	TARE	Zero point
L11	TARE	First adjustment weight (10 kg)
L21	TARE	Second adjustment weight (10 kg)
L31	TARE	Third adjustment weight (10 kg)
L41	BG/NEt	Terminate linearization (4-point linearization)
03 CLn		

Example 2: 5-point linearization/ 30 kg (5 kg, 10 kg, 10 kg, 5kg)

Display	Button	Explication
03 CLn	TARE	Linearization function
L0	TARE	Zero point
L11	TARE	First adjustment weight (5 kg)
L22	TARE	Second adjustment weight (10 kg); factor 2, i.e. twice as high as the first
L32	TARE	Third adjustment weight (10 kg); factor 2, i.e. twice as high as the first
L41		Fourth adjustment weight (5 kg), factor 1, i.e., the same size as the first
L51	BG/NEt	Terminate linearization (5-point linearization)
03 CLn		

Example 4: 5-point linearization/ 30 kg (5kg, 5kg, 10 kg, 10kg)

Display	Button	Explication
03 CLn	TARE	Linearization function
L0	TARE	zero point
L11	TARE	First adjustment weight (5 kg)
L21	TARE	Second adjustment weight (5kg), factor 1, i.e., the same size as the first
L32	TARE	Third adjustment weight (10 kg); factor 2, i.e. twice as high as the first
L42		Fourth adjustment weight (10 kg); factor 2, i.e. twice as high as the first
L51	BG/NEt	Terminate linearization (5-point linearization)
03 CLn		

Example 4: 7-Point linearization / 30 kg (1 kg, 2 kg, 5 kg, 10 kg, 2 kg, 10 kg)

Display	Button	Explication
03 CLn	TARE	Linearization function
L0	TARE	zero point
L11	TARE	First adjustment weight (1 kg)
L22	TARE	Second adjustment weight (2 kg); factor 2, i.e. twice as high as the first
L3 5	TARE	Third adjustment weight (5 kg); Factor 5 i.e. 5 times as high as the first
L4 A	TARE	Forth adjustment weight (10 kg); Factor A i.e. 10 times as high as the first
L52	TARE	Fifth adjustment weight (5kg); factor 2, i.e. twice as high as the first
L6 A	TARE	Sixth adjustment weight (10 kg); Factor A i.e. 10 times as high as the first
L71	BG/NEt	Terminate linearization (7-point linearization)
03 CLn		

19.3 Adjustment of "verified weighing systems / menu block 02 CAL"

i	<ul style="list-style-type: none"> • Prepare the required adjustment weight. The weight to be used depends on the capacity of the scale. Carry out adjustment as near as possible to the scale's maximum weight. Info about test weights can be found on the Internet at: http://www.kern-sohn.com. • Observe stable environmental conditions. Stabilisation requires a certain warm-up time.
----------	--

Call up the navigation in the menu/ function:

⇒ Call up function 02 CAL, see chapter 19.

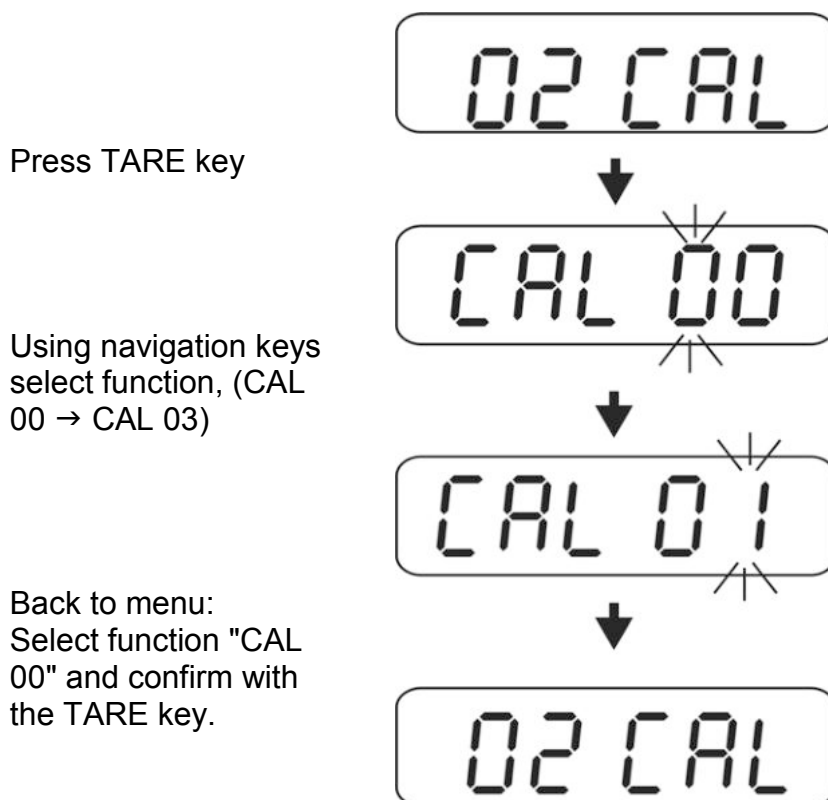

Overview:

CAL 00	Exit menu
CAL 01	Adjustment with external adjustment weight
CAL 02	Not documented (adjustment with gravitational constant)

Perform external adjustment / function "CAL 01":

⇒ Call up function "CAL 01"



⇒ Press the TARE button, the currently set adjustment weight is displayed. The last digit flashes.

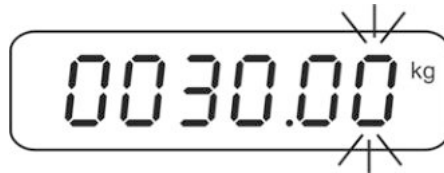

To change the adjustment weight select the digit to be changed with BG/ NET key, the active digit flashes. Enter the desired value with the navigation keys. Press the TARE key repeatedly, until "-----" is indicated.

⇒ Ensure that there are no objects on the weighing pan. Press the TARE key.

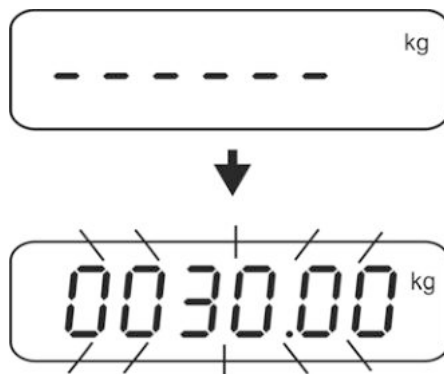

The weight value of the required adjustment weight will be displayed.

- ⇒ Carefully place the adjusting weight into the centre of the balancing plate and press the TARE key.
After successful adjustment, an acoustic signal sounds.



- ⇒ Remove the adjustment weight. Press any key, the scale will return to the menu..

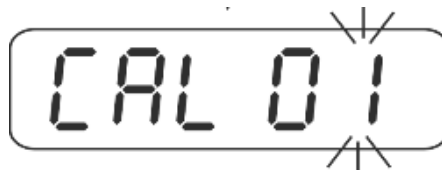

- ⇒ With the navigation keys (see chapter 2.1.1) select "CSP 00".



- ⇒ Confirm with TARE key.



- ⇒ To exit the menu, move the adjustment switch into the „LOCK” position, see chapter 19.

19.4 Amend the local gravitation zone/ menu block 06 CLr

⇒ Call up function 06 CLr, see chapter 19.

Press TARE key

A digital display showing the menu code '06 CLr' in a seven-segment font.

The current setting will be displayed.

A digital display showing the current setting '9.80744'. Small arrows point to the top and bottom of the digits '9' and '4', indicating they are the current focus for adjustment.

Using the navigation buttons, enter the local gravitational zone.

A digital display showing the adjusted setting '9.80763'. Small arrows point to the top and bottom of the digits '3' and '6', indicating they are the current focus for adjustment.

Confirm with the TARE key, the display returns back to the menu.

A digital display showing the menu code '06 CLr' after confirmation.

⇒ To exit the menu, move the adjustment switch into the „LOCK“ position, see chapter 19.

19.5 Appliance settings/ menu block 04 CFn

Call up the navigation in the menu/ function:

⇒ Call up function 04 CFn, see chapter 19.

Press TARE key

04 CFn

Using the navigation keys, select function, (CFn 00 → CFn 07)

CFn 00

Back to menu:
Select function "CFn 00" and confirm with the TARE key.

CFn 00

04 CFn

Overview:

CFn 00	Exit menu
CFn 01	Parameter "adjustment to site conditions"
CFn 02	OIML
CFn 03	Zero at power on
CFn 05	Data-Hold function
CFn 06	Zero-tracking
CFn07	Parts counting on / off

19.5.1 Parameter „adjustment to site conditions“ (function „CFn 01“)



In the case of change to the settings in CFn 01 the settings in FNC 05 are automatically overwritten, see chapter 10.5.

⇒ Call up function „CFn 01“, see chapter 19.5.

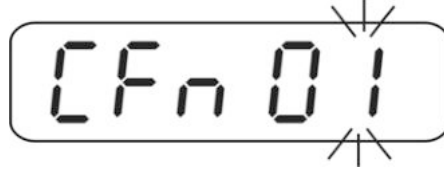

⇒ Press the TARE-key, current setting appears.

⇒ Select desired settings with TARE or UNIT key.

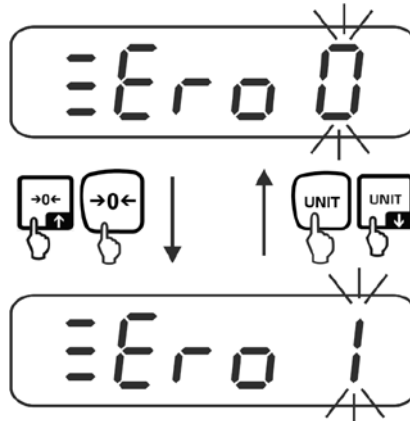

Zero 0	Switch Automatic zero-adjusting switch on and off and select zero range.
↓	
Zero 9	You can select 0 (switched off), 1d, 2d, 3d, 4d, 5d, 6d, 7d, 8d, 9d Default setting: „0“

⇒ Confirm with TARE key, the current stability settings are indicated.

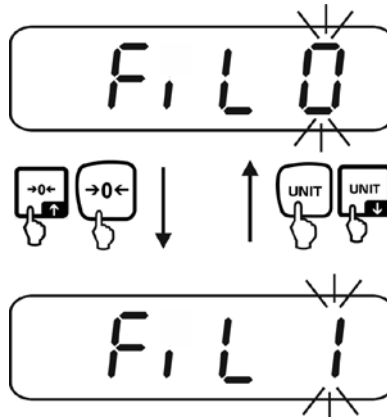

FiL 0 ↓ FiL 9	The higher the value, the more priority is given to stability. You can select 0 - 9. Factory setting "0".
-----------------------------------	--

⇒ Confirm with the TARE key, the current response level is displayed.

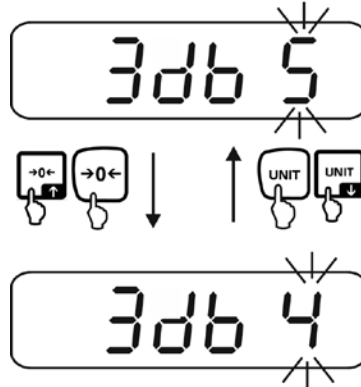

3 db 0 ↓ 3 db 9	The higher the value, the more priority is given to response. You can select 0-9. Factory setting "5".
-------------------------------------	---

i	With the functions "FiL" and "3 db", there is the possibility to select the stability of the display and the degree of response of the weighing system on the requirements of specific applications or environmental conditions. Please note that in general slowing down reaction times result in higher stability of the set data handling, while speeding up reaction times have an influence on the stability deterioration.
----------	---

⇒ Confirm with the TARE key, the display returns back to the menu.

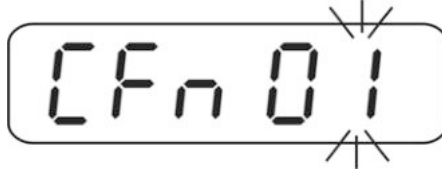

⇒ With the navigation keys (see chapter 2.1.1) Select "CFn 00".

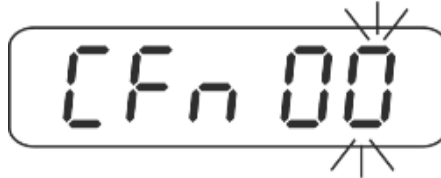

⇒ Confirm with TARE key.



⇒ To exit the menu, move the adjustment switch into the „LOCK“ position, see chapter 19.

19.5.2 Configuration „verified/ unverified“ (function „CFn 02“)

⇒ Call up function „CFn 02“, see chapter 19.

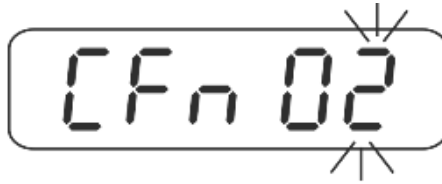

⇒ Press the TARE-key, current setting appears.

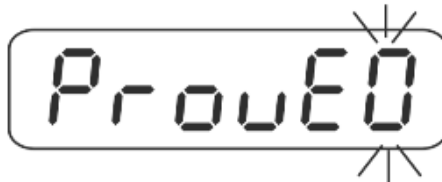

⇒ With the navigation keys (see chapter 2.1.1) select the desired setting.

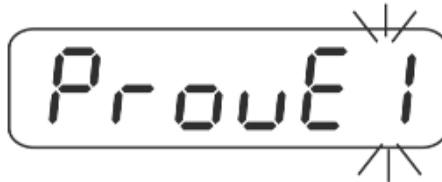

0 ⇒	Non verified models
1 ⇒	Verified models:
2 ⇒ ↓	Not documented
7 ⇒	

⇒ Confirm with the TARE key, the display returns back to the menu.



⇒ With the navigation keys (see chapter 2.1.1) Select "CFn 00".



⇒ Confirm with TARE key.

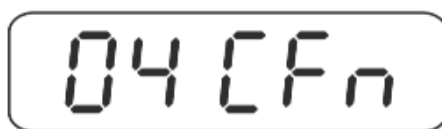

⇒ To exit the menu / return back to the weighing mode, see chapter 19.1.1 and/or 19.1.2.

19.5.3 Resetting to zero when switched on (function "CFn 04")

⇒ Call up function „CFn 04“, see chapter 19.

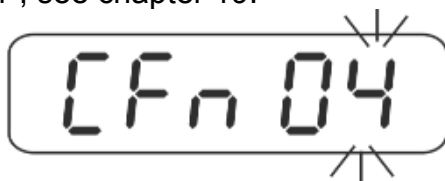

⇒ Press the TARE-key, current setting appears.

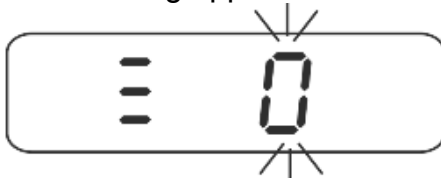

⇒ With the navigation keys (see chapter 2.1.1) select the desired setting.

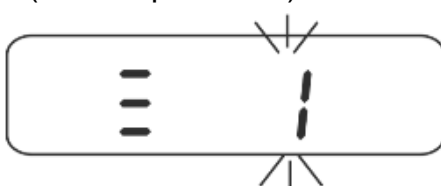

0 ⇒	Zero setting when switching on within ± 10 % Max. Factory setting verified models (CFn 02 = 1)
1 ⇒	Zero setting when switching on within ± 20 % Max.
2 ⇒	Zero setting when switching on within ± 30 % Max.
3 ⇒	Zero setting when switching on within ± 40 % Max.
4 ⇒	Zero setting when switching on within ± 50 % Max.
5 ⇒	Zero setting when switching on within ± 60 % Max.
6 ⇒	Zero setting when switching on within ± 70 % Max.
7 ⇒	Zero setting when switching on within ± 80 % Max.
8 ⇒	Zero setting when switching on within ± 90 % Max.
9 ⇒	Zero setting when switching on within ± 100 % Max. Factory setting unverified models (CFn 02 = 0)

⇒ Confirm with the TARE key, the display returns back to the menu.

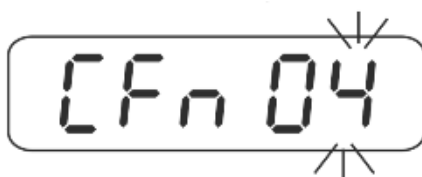

⇒ Select "CFn 00" with the navigation keys.

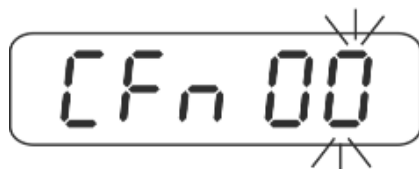

⇒ Confirm with TARE key.

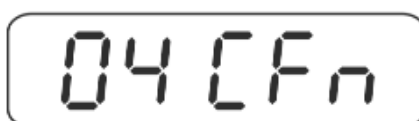

⇒ To exit the menu / return back to the weighing mode, see chapter 19.1.1 and/or 19.1.2.

19.5.4 Amend the DATA Hold function of verified weighing system (function „CFn 05“)

⇒ Call up function „CFn 05“, see chapter 19.



⇒ Press the TARE-key, current setting appears.

⇒ Select desired settings with TARE or UNIT key.

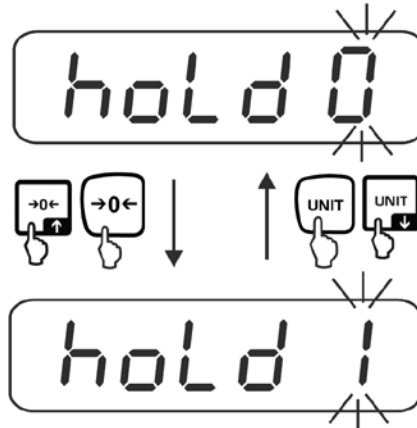

hold 0	Function switched off (factory setting)
hold 1	Peak value function This function indicates the highest load factor (peak value) of a continuously rising load. The peak value remains in the display until it is deleted with any key.
hold 2	„Stable hold 1“ mode The weight value is held automatically after reaching a stable value up to the manipulation of any key in the display.
hold 3	„Stable hold 2“ mode The weight value is held in the display after reaching a stable value until the load falls under 10d.
hold 4	Animal weighing (see chap. 10.6.1) This function is suitable for jerky weighing procedures, see following chapter 10.6.1

⇒ Confirm with the TARE key, the display returns back to the menu.

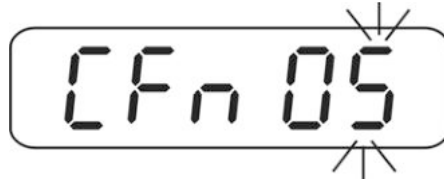

⇒ With the navigation keys (see chapter 2.1.1) Select "CFn 00".

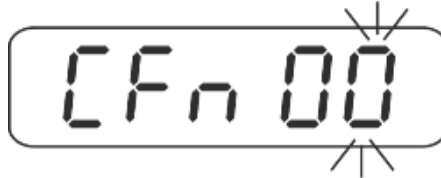

⇒ Confirm with TARE key.



⇒ To exit the menu, move the adjustment switch into the „LOCK“ position, see chapter 19.

19.5.5 Auto zero (verified weighing systems)/ function "CFn 06"

⇒ Call up function „CFn 05“, see chapter 19.

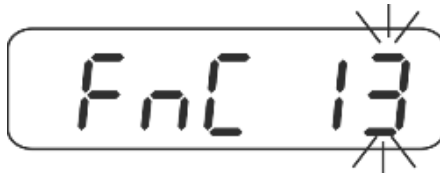

⇒ Press the TARE-key, current setting appears.

⇒ Select desired settings with TARE or UNIT key.

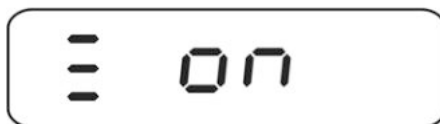

off	Function switched off
on	When the balance is cleared the zero point is corrected automatically.

⇒ Confirm with the TARE key, the display returns back to the menu.

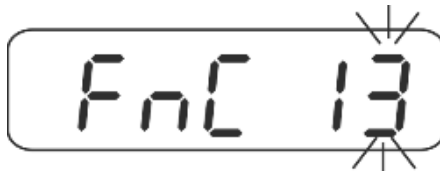

⇒ To exit the menu, move the adjustment switch into the „LOCK“ position, see chapter 19.

19.5.6 Parts counting on / off „CFn 07“

⇒ Call up function „CFn 07“, see chapter 19.

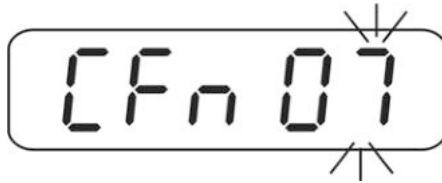

⇒ Press the TARE-key, current setting appears. (PCS off / PCS on).

⇒ Select desired settings with TARE or UNIT key.



PCS off	Parts counting disabled
PCS on	Parts counting enabled

⇒ Confirm with the TARE key, the display returns back to the menu.

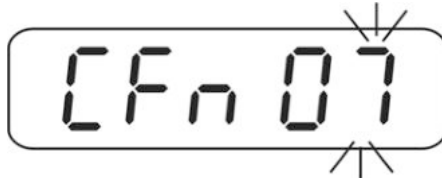

⇒ To exit the menu, move the adjustment switch into the „LOCK“ position, see chapter 19.

