

Operating manual Electronic Crane Scales

Logbook Regular maintenance and care

KERN HCD

Version 1.3
2020-02
GB



HCD-BA-e-2013



KERN HCD

Version 1.3 2020-02

Operating instructions / logbook Electronic Crane Scales

Contents

1.	Technical data	3
1.1	Dimensions (mm)	5
1.2	Type plate	6
2.	General Safety Instructions	7
2.1	Duties of the owner-operator	7
2.2	Organizational measures	7
2.3	Environmental conditions	8
2.4	Pay attention to the instructions in the Operation Manual	8
2.5	Proper use	8
2.6	Improper Use	8
2.7	Warranty	9
2.8	Safe working	9
2.9	Monitoring of Test Resources	9
2.10	Testing upon acceptance	9
2.11	Initial Commissioning	9
2.12	Shutdown and storage	9
3.	Operating elements	10
3.1	Remote control	11
3.2	Label	12
4.	Commissioning	13
4.1	Unpacking	13
4.2	Before first use check the dimensions and note them down on the checklist	14
4.3	Battery operation	14
4.4	Suspending the balance	15
5.	Operation	16
5.1	Safety instructions	16
5.2	Loading the crane scales	17
5.3	Turn on/off	20
5.4	Taring	20
5.5	Weighing	20
5.6	Switch-over weighing unit	21
5.7	Functions	21
6.	Menu	24
7.	Adjustment	25
8.	Maintenance, Repair, Cleaning and Disposal	26
8.1	Cleaning and Disposal	26
8.2	Regular maintenance and care	27
8.3	Checklist „Regular maintenance“	28
8.4	Maintenance table	29
8.5	Drawings of a hook, shackle and crane scale	30
8.6	Inspection cycles	31
8.7	Drawing with “h” dimension	32
9.	Enclosure	33
9.1	Checklist „Enhanced maintenance“ (General revision)	33
9.2	List „spare parts and repair of safety-relevant parts“	34

1. Technical data

KERN	HCD 60K-2	HCD 100K-2	HCD 300K-1
Item no./ Type	THCD 60K-2-A	THCD 100K-2-A	THCD 300K-1-A
Readability (d)	0.02 kg	0.05 kg	0.1 kg
Weighing range (max)	60 kg	150 kg	300 kg
Taring range (subtractive)	60 kg	150 kg	300 kg
Reproducibility	0.02 kg	0.05 kg	0.1 kg
Linearity	± 0.04 kg	± 0.1 kg	± 0.2 kg
Recommended adjustment weight, not added (class)	50 kg (M1)	100 kg (M1)	200 kg (M1)
Stabilization time	2 s		
Precision	0.2 % of max.		
Warm-up time	10 min		
Units	kg, lb, N		
Allowable ambient temperature	+5...+40 °C		
Relative humidity	0 to 80 %, non-condensing		
Battery (in series)	4 x 1.5V AA Operating time backlight on 37 h Operating time backlight off 100 h		
Rechargeable battery	Optional		
Input voltage Appliance	9V, 300 mA		
Input voltage Mains adapter	100V - 240V AC, 50/60 Hz		
Display	Digit height 28 mm		
Display housing Dimensions Width x Depth x Height, (mm)	150 x 79 x 97		
Housing material	Synthetic material		
Load hook material	Painted steel		
Net weight (kg)	0.85		
Remote control (standard equipment) wireless	Battery Size CR2025 (1 x 3V)		

KERN	HCD 100K-2D	HCD 300K-2D
Item no./ Type	THCD 100K-2D-A	THCD 300K-2D-A
Readability (d)	0.02 kg; 0.05 kg	0.05 kg; 0.1 kg
Weighing range (max)	60 kg; 150 kg	150 kg; 300 kg
Taring range (subtractive)	60 kg; 150 kg	150 kg; 300 kg
Reproducibility	0.02 kg; 0.05 kg	0.05 kg; 0.1 kg
Linearity	±0.04 kg; 0.1 kg	±0.1 kg; 0.2 kg
Recommended adjustment weight, not added (class)	100 kg (M1)	200 kg (M1)
Stabilization time	2 s	
Precision	0.2 % of max.	
Warm-up time	10 min	
Units	kg, lb, N	
Allowable ambient temperature	+5...+40 °C	
Relative humidity	0 to 80 %, non-condensing	
Battery (in series)	4 x 1.5V AA Operating time backlight on 37 h Operating time backlight off 100 h	
Rechargeable battery	Optional	
Input voltage Appliance	9V, 300 mA	
Input voltage Mains adapter	100V - 240V AC, 50/60 Hz	
Display	Digit height 28 mm	
Display housing Dimensions Width x Depth x Height, (mm)	150 x 79 x 97	
Housing material	Synthetic material	
Load hook material	Painted steel	
Net weight (kg)	0.85	
Remote control (standard equipment) wireless	Battery Size CR2025 (1 x 3V)	

1.1 Dimensions (mm)

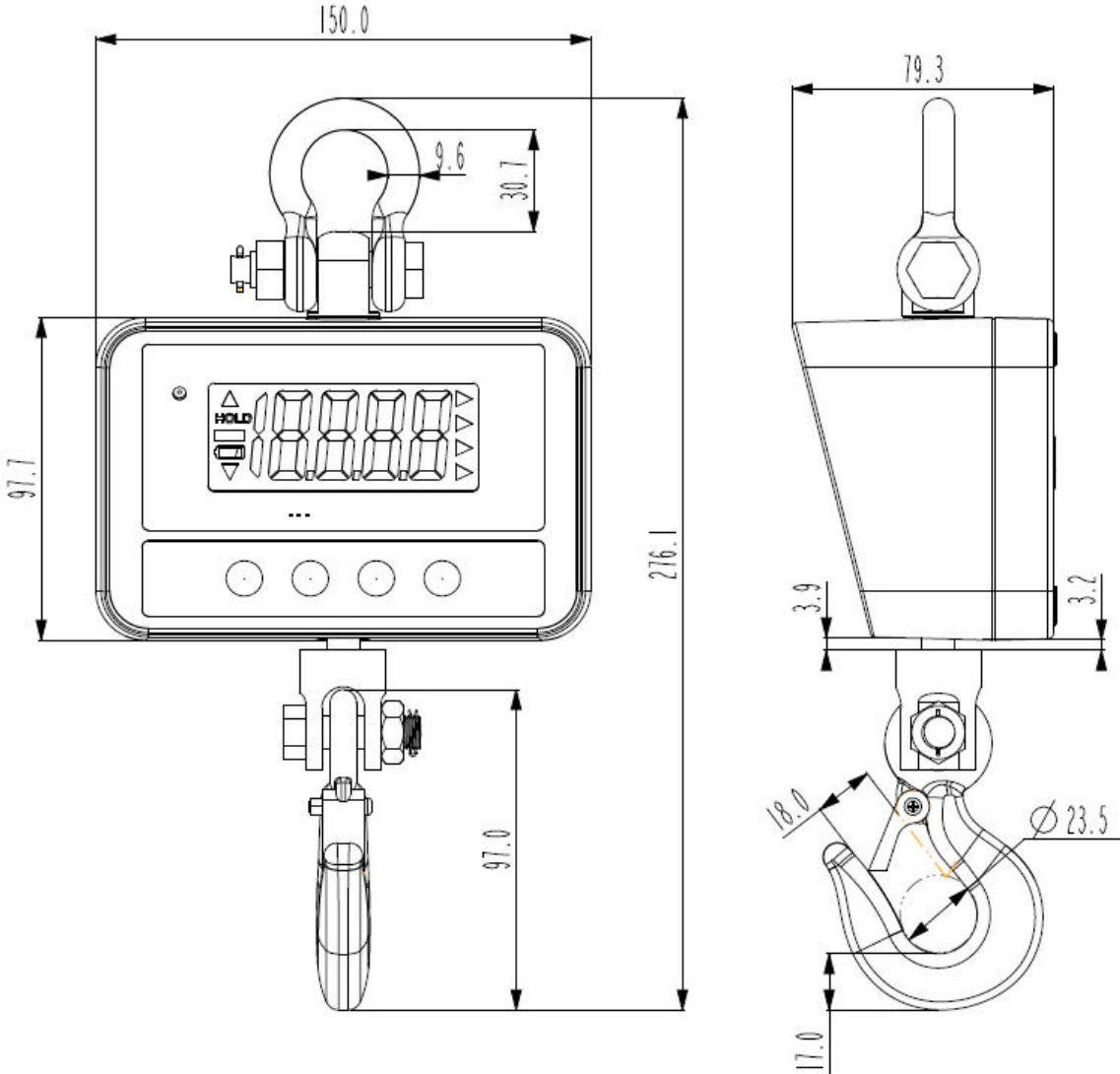

1.2 Type plate



1	KERN Logo
2	Model designation
3	Weighing range [Max], Readability [d]
4	Data for power supply
5	Product No
6	Serial number
7	Date of Manufacture
8	Disposal mark
9	Company address

2. General Safety Instructions

2.1 Duties of the owner-operator

Follow national accident prevention regulations and all operator health and safety at work and operating regulations.

- Observe all safety regulations of the crane manufacturer.
- The balance may only be used for the proposed purpose. Any type of use which is not specified in these operating instructions, will be considered as improper use. The customer is solely responsible for material damage and injury of persons resulting from an improper use, Messrs. KERN & Sohn will not be liable under any circumstance.
Messrs. KERN & Sohn cannot be held liable, if the crane scales are modified or used improperly and if damage is resulting from such use.
- Inspect and service crane scales, crane and load suspension devices regularly (see chap. 8).
- Log the test result and keep it in the logbook.

2.2 Organizational measures

- Only trained and instructed staff may operate the balance.
- Make sure that the operating instructions are kept nearby the operation site of the crane scales.
- Assembly, commissioning and maintenance should only be carried out by trained specialists.
- Repair of safety-relevant pieces may only be carried out by the company OH&S specialist.
- Use original spare parts only.
- All repairs and spare parts must be documented by the service partner (see list, chap. 9.2).
- All maintenance must be documented (see checklist chap. 8.3).
- Load suspending components may only be exchanged as a complete spare parts set. The dimensions of the new components must be noted (see checklist chapter. 8.3).

2.3 Environmental conditions

- Never operate the crane scales in explosive environment. The serial version is not explosion protected.
- Operate the crane scales only under environmental conditions as specified in these operating instructions (especially in chapter 1 „Technical data“).
- Do not expose the crane scales to strong humidity. Non-permitted condensation (condensation of air humidity on the appliance) may occur if a cold appliance is taken to a considerably warmer environment. In this case, acclimatize the disconnected appliance for ca. 2 hours at room temperature.
- Do not operate the crane scales in corrosive environment.
- Protect the crane scales against high humidity, vapours and dust.
- Major display deviations (incorrect weighing results) may be experienced should electromagnetic fields (e.g. due to mobile phones or radio equipment), static electricity accumulations or instable power supply occur. Change location or remove source of interference.

2.4 Pay attention to the instructions in the Operation Manual



Carefully read this operation manual before setup and commissioning, even if you are already familiar with KERN balances.

2.5 Proper use

The balance you purchased is intended to determine the weighing value of material to be weighed. It is intended to be used as a “non-automatic” balance, i.e. the material to be weighed is suspended on the crane hook only vertically, manually, carefully and without jerks. As soon as a stable weighing value is reached the weighing value can be read.

- Use the crane scales only for lifting and weighing of freely movable loads.
- Danger of injury due to improper use. Not allowed are e.g.:
 - Exceeding the allowed nominal load of crane, crane scales or any type of load attachment devices
 - Conveying persons,
 - Pulling loads over an inclined surface,
 - Tearing-off, pulling or towing loads.
- Modifications or reconstructions of the crane scales or of the crane are not allowed.

2.6 Improper Use

Do not use balance for dynamic weighing. In the event that small quantities are removed or added to the material to be weighed, incorrect weighing results can be displayed due to the “stability compensation”. (Example: Slowly draining fluids from a container suspended on the balance.) Do not leave permanent load suspended on the balance. This may damage the measuring system as well as safety-relevant parts.

The balance may only be used according to the described conditions. Other areas of use must be released by KERN in writing.

2.7 Warranty

Warranty claims shall be voided in case

- Our conditions in the operation manual are ignored
- The appliance is used outside the described uses
- The appliance is modified or opened
- Mechanical damage and damage caused by media, liquids,
- Natural wear and tear
- The appliance is improperly set up or incorrectly electrically connected
- The measuring system is overloaded

2.8 Safe working

- Do not stand underneath suspended loads!
- Position the crane in a way that the load is lifted vertically.
- When working with the crane and crane scales wear personal safety equipment (helmet, safety shoes etc.).

2.9 Monitoring of Test Resources

In the framework of quality assurance the measuring-related properties of the balance and, if applicable, the testing weight, must be checked regularly. The responsible user must define a suitable interval as well as type and scope of this test. Information is available on KERN's home page (www.kern-sohn.com) with regard to the monitoring of balance test substances and the test weights required for this. In KERN's accredited DKD calibration laboratory test weights and balances may be calibrated (return to the national standard) fast and at moderate cost.

2.10 Testing upon acceptance

When receiving the appliance, please check packaging immediately, and the appliance itself when unpacking for possible visible damage.

2.11 Initial Commissioning

In order to obtain exact results with the electronic balances, your balance must have reached the operating temperature (see warming up time chap. 1).

During this warming up time the balance must be connected to the power supply (accumulator or battery).

The accuracy of the balance depends on the local acceleration of gravity.

Strictly observe hints in chapter Adjustment.

For checking original dimensions, see chap. 4.2

2.12 Shutdown and storage

- Take off the crane scales from the crane and dismantle all load attachment devices from the crane scales.
- Do not store the crane scales at open air





3. Operating elements



Overview of display:





▶ kg	The current measuring unit is kilogram	
▶ lb	The current measuring unit is pound	
▶ N	The current measuring unit is Newton	
▲	Marks the weight value depending on the active setting H1-H6.	
	H1-H4:	Data-Hold function
	H5	Animal weighing function
	H6	Peak value function
🔋	Capacity of battery exhausted	
HOLD	Data hold function active	

Keyboard overview:

Button	Description of function
	<ul style="list-style-type: none"> • Turn on or off the balance
	<ul style="list-style-type: none"> • Record weight value (freeze)
	<ul style="list-style-type: none"> • Switch over weighing unit (kg→lb→N)
	<ul style="list-style-type: none"> • Taring • Zeroing

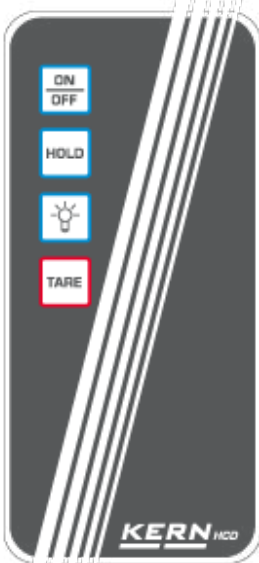
3.1 Remote control

The balance can be operated by the remote control like by a keyboard.

		<ul style="list-style-type: none"> • Turn on or off the balance
		<ul style="list-style-type: none"> • Record weight value (freeze)
		<ul style="list-style-type: none"> • Switch on background illumination of the display for 30 s (menu setting <bl→on>)
		<ul style="list-style-type: none"> • Taring • Zeroing

3.2 Label



- ⇒ Do not stand or go under suspended loads.
- ⇒ Do not use on building site.
- ⇒ Keep an eye on suspended loads.



(example)

- ⇒ Do not exceed the nominal load of crane, crane scales or any kind of load attachment devices at the crane scales.





- ⇒ The product conforms to the requirements of the German Equipment and Product Safety Act.

4. Commissioning

	<p> Always observe chapter 2 „General Safety Instructions“!</p>
---	---

4.1 Unpacking

 <p>SAFETY INSTRUCTIONS for protection against break</p>	<p>Once delivered and unpacked, crane scales will not be taken back.</p>
	<p>The crane scales have been sealed by Messrs. KERN.</p> <p>⇒ Shackles and hooks are sealed by KERN tape.</p> <p>⇒ The packaging is also sealed by adhesive tape.</p> <p> Broken seal obliges to purchase.</p> <div data-bbox="858 869 1098 1106" style="text-align: center;"></div> <p>Fig.: Seal</p>
	<p>Thanks for your comprehension. Your KERN Quality assurance team</p>

Only use original packaging for returning.

- ⇒ Make sure that all parts are completely present.
- Crane scales
 - Remote control
 - Batteries (4 x 1,5V AA)
 - Operating instructions (logbook)

4.2 Before first use check the dimensions and note them down on the checklist

⇒ Enter the dimensions in the checklist (see chapter 8.3) as per the drawings in chapter 8.4. For that purpose, use appropriate control measures.

4.3 Battery operation

If the batteries are empty, the battery icon on the LCD will flash. If the battery voltage is too low, the battery icon and "Lo" will flash for 10 seconds then the scale will switch off.

Press **ON/OFF**-button and replace the batteries.

Open battery compartment, replace batteries and close battery compartment again.

In order to save the battery, the balance switches automatically off after 4 minutes without weighing. This auto-off function can be deactivated in the menu.

When the suspended balance is out of operation for a longer period, remove the batteries.

4.4 Suspending the balance

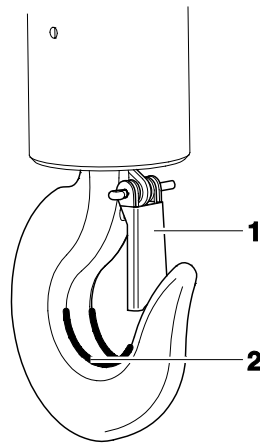

Condition

The crane needs a safety bracket (1) that the unloaded crane scales cannot fall down.





If the safety bracket is missing or damaged, please contact the crane manufacturer in order to receive a hook with this safety equipment.

⇒ Suspend the crane scales on the lower hook of a crane and close the safety bracket.

The crane scale's upper eyelet should rest in the saddle (2).

5. Operation

5.1 Safety instructions

	 <p>Risk of injury due to falling loads!</p> <p>Danger</p>
  <p>(example)</p>	<ul style="list-style-type: none"> ⇒ Take great care when operating the crane and follow the general rules for crane operation. ⇒ Check all parts (hook, eyelet, rings, rope slings, cables, chains etc.) for excessive wear or damage ⇒ If faults can be seen on the safety bracket of the hook or if it is missing completely, the scales must not be used ⇒ Work only with appropriate speed ⇒ Always avoid vibrations and horizontal forces. Avoid any kind of shock, torsion and oscillating (e.g. caused by inclined suspending) ⇒ Do not use the crane scales for transporting loads. ⇒ Do not stand or go under suspended loads. ⇒ Do not use on building site. ⇒ Keep an eye on suspended loads. ⇒ Do not exceed the nominal load of crane, crane scales or any kind of load attachment devices at the crane scales. ⇒ When weighing dangerous goods such as melted mass, radioactive material), observe the prescriptions for handling dangerous goods!

5.2 Loading the crane scales

For good weighing results observe the following, illustrations see next page:

- ⇒ Only use load attachment devices which guarantee a one-spot suspension and where the scales can be suspended freely.
- ⇒ Do not use too large load attachment devices which do not guarantee any one-spot suspension.
- ⇒ Do not use multiple suspensions.
- ⇒ Do not pull or push the load or the loaded balance.
- ⇒ Do not pull the hook horizontally.

Loading the balance

1. Position the hook of the crane scales over the load.
2. Move downwards the crane scales until the load can be suspended on the hook of the balance. Reduce the speed when the respective height is going to be reached.
3. Suspend the load on the hook. Ensure that the safety bracket is closed. If the load is fixed by slings, ensure that the slings rest completely on the saddle of the balance hook.
4. Lift-off the load slowly.

When the load is fixed by slings, ensure that the load is well balanced on both sides and that the slings are correctly positioned

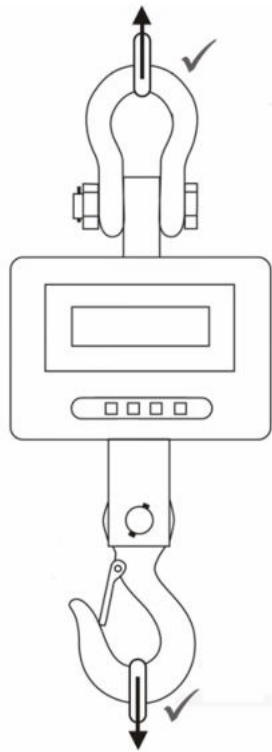

Only use load attachment devices which guarantee a one-point suspension and where the scales can be suspended freely.

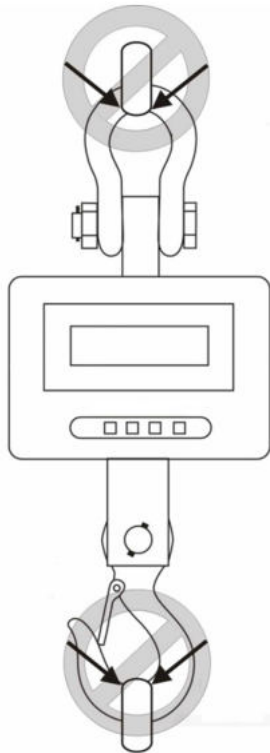

Do not use too large load attachment devices which cannot guarantee a one-point suspension.

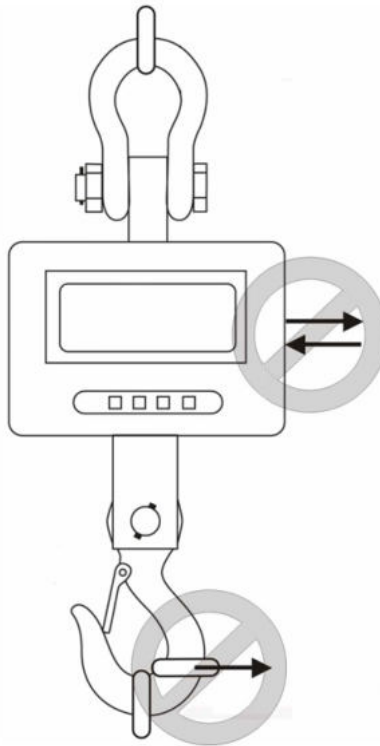

Do not push or pull

Do not pull the hook horizontally

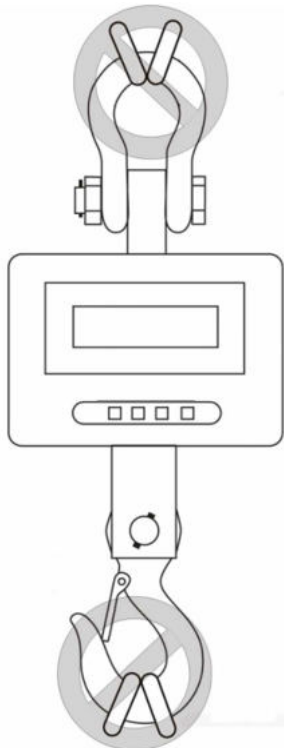

Do not use multiple suspensions

5.3 Turn on/off

Start-up

- ⇒ Press the **ON/OFF** button. The display lights up and the balance carries out a selftest. The selftest is completed when the weight value 0 appears on the display.

Switching Off

- ⇒ Press the **ON/OFF** button.

5.4 Taring

- ⇒ Suspend preload.
Press the **TARE** button, the zero display appears. The weight of the container is now internally saved.

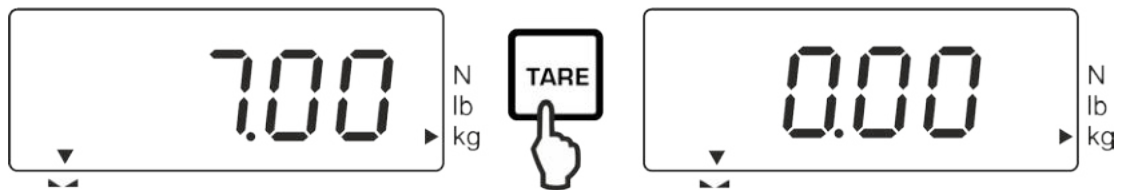

- ⇒ Weigh the material, the net weight will be indicated.
- ⇒ After removing the preload weight appears as negative display.
- ⇒ To delete the tare value, remove load from the suspended balance and press the **TARE** button.

5.5 Weighing

- ⇒ Load the suspended balance
- ⇒ Wait for stability display
- ⇒ Read weighing result

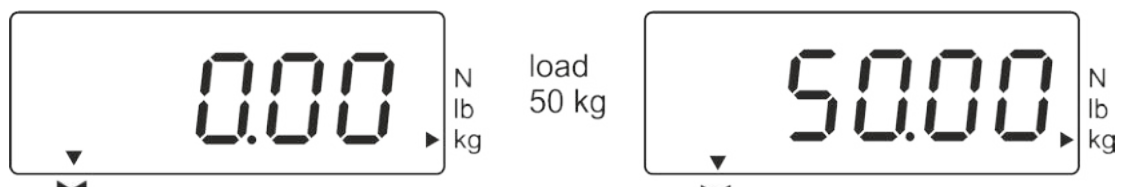

Overload warning

Overloading exceeding the stated maximum load (max) of the balance, minus a possibly existing tare load, must be strictly avoided. This could cause damage to the balance.

Exceeding the maximum load is indicated by the display „E“. Unload balance or reduce preload.

5.6 Switch-over weighing unit

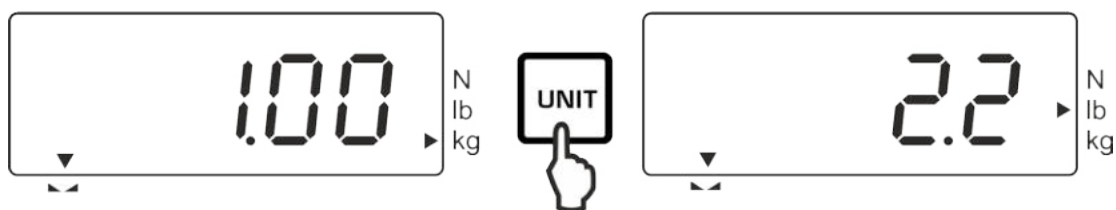

The next measuring unit will be displayed **kg**→**lb**→**N** after each press of the **UNIT** button. The ► indicator shows the active unit.

5.7 Functions

With help of the **Hold**-button the following functions can be activated:

Adjustment	Function	
H1	Data-Hold function 1 Weighing value frozen for 5 sec. after pressing the Hold -button	
H2	Data-Hold function 2 The weighing value will be frozen after pressing the Hold -button until another button is actuated	
H3	Data-Hold function 3 The weighing value is automatically frozen for 5 sec.	
H4	Data-Hold function 4 The weighing value is automatically frozen after reaching a stable value until a button will be actuated	
H5	Animal weighing function	☞ see chap. 5.7.2
H6	Peak value function	☞ see chap. 5.7.3

5.7.1 Data-Hold function

- ⇒ Switch on the balance, keep the **HOLD**-button pressed until the current setting „Hx“ (H1 – H6) appears.
- ⇒ Press **ON/OFF** button repeatedly until the desired setting „H1-H4“ is displayed.
- ⇒ Confirm setting with the **HOLD** button.
- ⇒ Suspend the material to be weighed
- ⇒ The weight value is fixed and displayed depending on the setting (H1 – H4) (see chap. 5.7), symbolised by the [▲] top left.

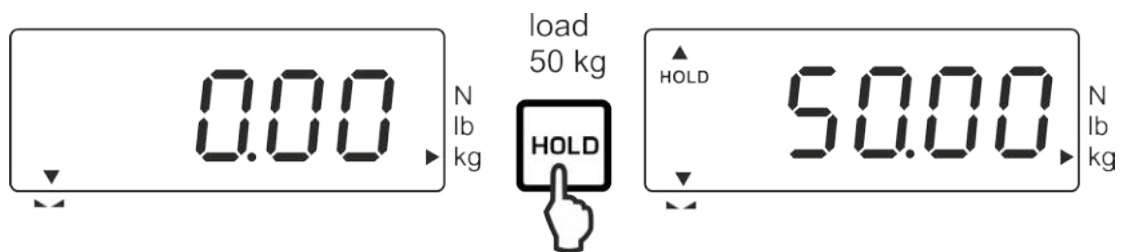

5.7.2 Animal weighing function

This function is suitable for busy weighing procedures. The result is a mean value formed by 16 weighing values which is found out within 3 seconds.

- ⇒ Switch on the balance, keep the **HOLD**-button pressed until the current setting „Hx“ (H1 – H6) appears.
- ⇒ Press **ON/OFF** button repeatedly until the setting „H5“ is displayed.
- ⇒ Confirm setting with the **HOLD** button.
- ⇒ Suspend the material to be weighed
- ⇒ Press the **HOLD**-button, the display counts reverse from 3 -1.
The calculated mean value is indicated, symbolised by the [▲] top left.
- ⇒ Before further measurements press first the **TARE**-button.

5.7.3 Peak value function

This function displays the highest load value (peak value) of a weighing.
Measuring frequency: 200ms

Attention:



Never exceed the maximum permitted load of the peak value on the balance (!!Danger of breaking!!).

- ⇒ Switch on the balance, keep the **HOLD**-button pressed until the current setting „Hx“ (H1 – H6) appears.
- ⇒ Press **ON/OFF** button repeatedly until the setting „**H6**“ is displayed.
- ⇒ Use the **HOLD**-button to confirm your selection
- ⇒ Suspend the material to be weighed
- ⇒ The peak value appears for a short time, symbolised by the [▲] top left. The balance returns automatically to zero and is ready for further measurement.

6. Menu

- ⇒ When the balance is switched off, press the **HOLD**-button and keep it pressed
- ⇒ Do not release the **HOLD**-button. Press also the **ON/OFF** -button and keep it pressed
- ⇒ Keep the **ON/OFF**-button pressed, however release the **HOLD**-button
- ⇒ Press **HOLD**-button anew
- ⇒ Keep both buttons pressed until in the display “**tr**” appears
- ⇒ Release both buttons. The balance is situated in the menu.
- ⇒ Using the **ON/OFF**-button you can select between the following functions:

Function	Settings	Description
tr Zero tracking	on	Auto Zero
	off	
AF Auto off	off 5 off 10 off 20 off 30	Automatic switch-off function after 3, 5, 10, 20 or 30 min.
bL Background illumination of the display	on	Background illumination on
	off	Background illumination off
	Ch	The background illumination will be switched off automatically 10 sec after having reached a stable weighing value.
rST	YES	Reset to factory setting
	NO	

- ⇒ Press the **HOLD** button to confirm the selected function
- ⇒ In the display appears the current setting „**ON**“ or „**OFF**“. With help of the **ON/OFF** -button you can select between „**ON**“ or „**OFF**“. Confirm your selection with the **HOLD**-button. After a short period the balance returns automatically to weighing mode.

7. Adjustment

As the acceleration value due to gravity is not the same at every location on earth, each balance must be coordinated - in compliance with the underlying physical weighing principle - to the existing acceleration due to gravity at its place of location (only if the balance has not already been adjusted to the location in the factory). This adjustment process must be carried out for the first commissioning, after each change of location as well as in case of fluctuating environment temperature. To receive accurate measuring values it is also recommended to adjust the balance periodically in weighing operation.

Observe stable environmental conditions. A warming up time of approx. 1 minute is recommended for stabilization.

Prepare adjustment weight, for details see chap. 1 „Technical data“.

⇒ Switch on balance



⇒ Press **Unit** button and hold down (approx. 3 secs) until „CAL“ is displayed.



⇒ After that the weight value of the required adjustment weight (see chap. 1) is displayed.



⇒ Attach adjustment weight, a short time later „F“ will appear.

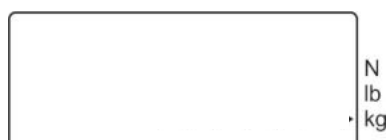

⇒ After adjustment the balance turns itself off again automatically.
In case of an adjustment error or wrong adjustment weight „E“ is displayed, repeat the adjustment process

8. Maintenance, Repair, Cleaning and Disposal

 <p>Danger</p>	<p>Risk of injury and risk of material damage! The crane scales is part of a hoisting device! For a safe operation please observe the following:</p> <ul style="list-style-type: none">⇒ Have carried out a regular maintenance by trained specialized staff⇒ Carry out regular maintenance and care, see chapter 8.2.⇒ Have the parts exchanged only by trained specialized staff.⇒ If there arose discrepancies with the safety checklist, the balance must not more be put into operation.⇒ Do not repair the crane scales by yourself. The repairs can be carried out solely by the company OH&S specialist.
--	---

8.1 Cleaning and Disposal

 <p>CAUTION</p>	<p>Damage on the crane scales!</p> <ul style="list-style-type: none">⇒ Do not use any industrial solutions or chemicals
--	--

- ⇒ Clean the keyboard and the display with a soft cloth soaked in mild window cleaning agent.
- ⇒ Disposal of packaging and appliance must be carried out by operator according to valid national or regional law of the location where the appliance is used.

8.2 Regular maintenance and care

- ▲ Regular inspections and maintenance works should be carried out at intervals stipulated in chapter 8.6.
- ▲ The regular 3-month maintenance may only be carried out by an expert with competent knowledge of working with crane scales. Thereby the national regulations for prevention of accidents as well as the working, operation and safety regulations of the owner-operator.
- ▲ Always use validated control measures/feeler gauges for checking.
- ▲ Regular technical inspections (every 12 months) can be carried out solely by the trained personnel (company OH&S specialist).
- ▲ The results of the maintenance must be written down in the checklist (chap. 8.3).
- ▲ The additional results of the extended maintenance have to be entered in the checklist (chapter 9.1).
- ▲ The replaced spare parts also must be entered, (chapter 9.2)

Regular maintenance:

<p>Initial start-up, every 3 months</p>	<ul style="list-style-type: none"> ▪ Enter and verify all dimensions, see the “Checklist”, chap. 8.3 ▪ Check the shackle or the eyelet for wear and tear, such as e.g. plastic deformation, mechanical damage (unevenness), notches, striation, cracks, corrosion, thread damage and torsions. ▪ Visual inspection and checking the function of the articulated joint ▪ Check the application of the safety bracket on the hook, moreover check for fault and correct function ▪ For balances of big construction size: Check that the split pin and the nut on the shackle are not loose <p>If a dimension exceeds the admitted deviation from the original dimension (see checklist, chap. 8.3) or if other discrepancies have been found, the balance must be repaired at once by trained specialized staff ((company OH&S specialist). Never do repair it by yourself! Take balance out of operation immediately!</p> <p>All repairs and spare parts must be documented by the service partner (see list, chap. 9.2).</p>
<p>Every 12 months</p>	<ul style="list-style-type: none"> ▪ All load-transferring parts must be verified and documented by personnel qualified for extended maintenance (see the “Checklist”, chap. 9.1).

Hint

During the revision watch out for wear and tear according to the following drawings (see chap. 8.4)

8.3 Checklist „Regular maintenance“

i Additional information on the maintenance works can be found in the table below (see chapter 8.4) and in figures in chapter 8.5.

	Shackle					Hook										Date	Inspector
	a	b	c	Wear (see grey fields)	Cotter pin and nut	d	e	f	g	h	Angle α	Wear (see grey fields)	Detent	Articulated joint			
Max. acceptable deviation	5%	0%	5%	No deformations or cracks	Well fixed	10%	5%	5%	5%	± 1 mm	10°	No deformations or cracks	Correct operation	Check function			
Dimensions before first use																	
3 months																	
6 months																	
9 months																	
12 months																	

bold letters = Those technical inspections must be carried out by the company OH&S specialist.

8.4 Maintenance table

Part	Drawing	Component	Inspection	Limits
Hook		Detent	Inspection concerning operation and damage	No damage is acceptable, operation must be ensured.
		Articulated joint	Check function	Correct operation
		Eye and hook	Inspection concerning dimensions and damage	As per Table 8.3
Shackle		Locking bolt	If it is not loose	It must not be loose.
		Shackle	Inspection concerning dimensions and damage	As per Table 8.3
		Cotter pin + nut	Inspection concerning damage and positioning	Correct positioning as per Table 8.3
Crane scale		Screw connections	Loose	It must not be loose.
		Crevice between the hook and the enclosure	Dimension check	As per Table 8.3

8.5 Drawings of a hook, shackle and crane scale

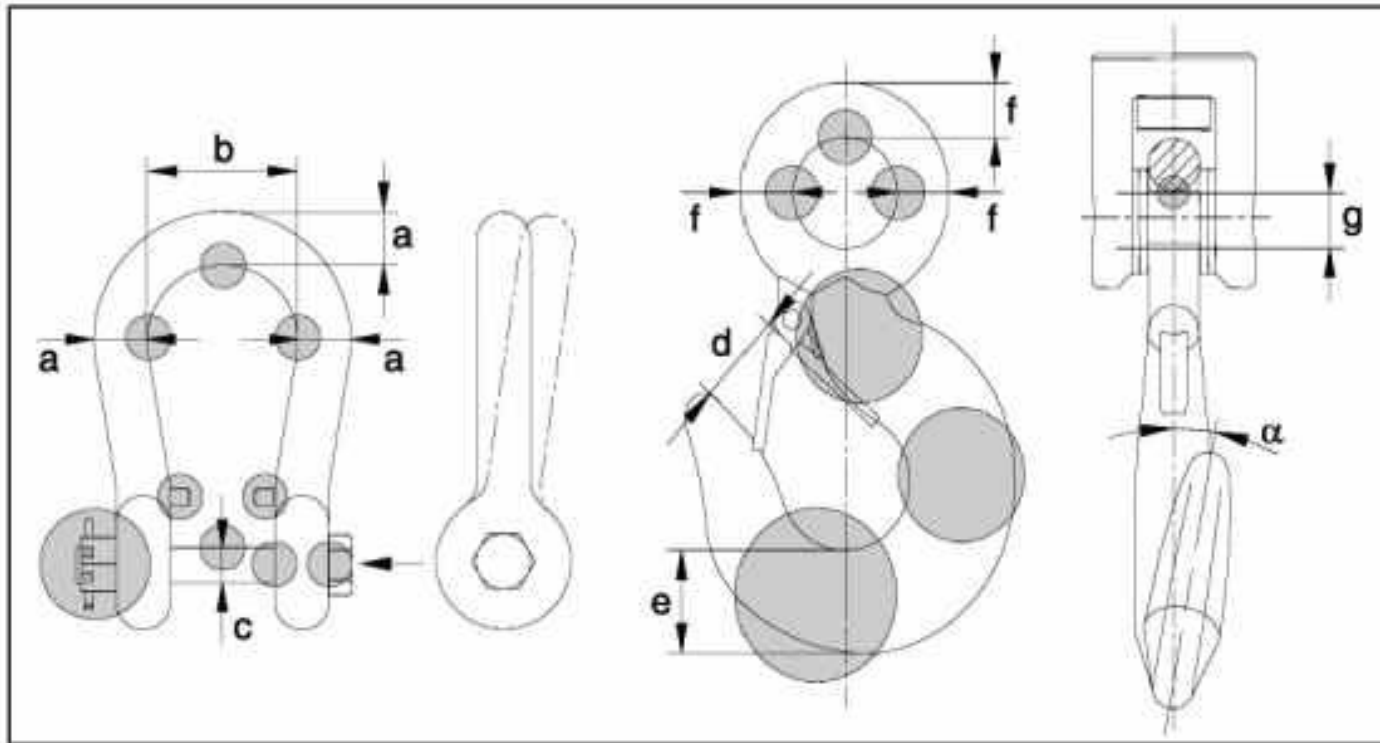

8.6 Inspection cycles

Inspection	Every day	Every 7 days	Every 3 months	Every 12 months
Presence of all crane scale parts	<input checked="" type="checkbox"/>			
Visual inspection for damage	<input checked="" type="checkbox"/>			
Visual inspection and operation inspection of the hook detent	<input checked="" type="checkbox"/>			
Visual inspection and checking the function of the articulated joint	<input checked="" type="checkbox"/>			
Inspection of the shackle cotter pin and nut	<input checked="" type="checkbox"/>			
Impurities		<input checked="" type="checkbox"/>		
Marking inspection (legible nameplate)		<input checked="" type="checkbox"/>		
Inspection of all dimensions as per the checklist 8.3			<input checked="" type="checkbox"/>	
Extended maintenance by the company OH&S specialist, see chapter 9.1				<input checked="" type="checkbox"/>

8.7 Drawing with “h” dimension

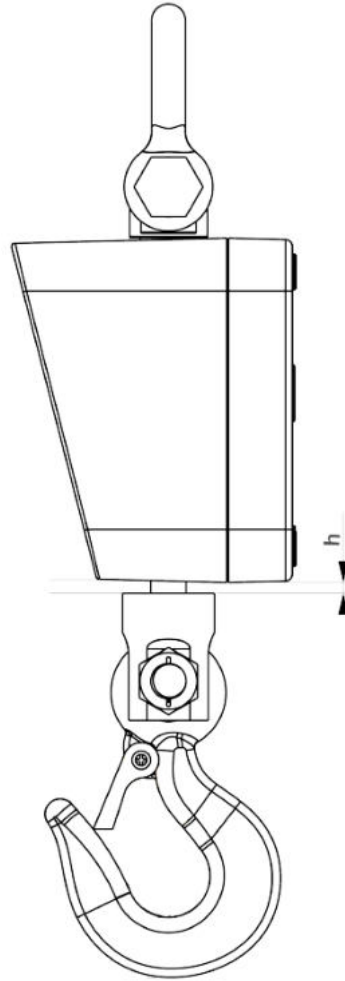

9. Enclosure

9.1 Checklist „Enhanced maintenance“ (General revision)

The enhanced maintenance has to be carried out by the company OH&S specialist.

Crane scales		Model Serial no.					
Interval	Magnetic powder test for cracks	Hooks	Shackle	Screwed connections	Date	Name	Signature
12 months							

9.2 List „spare parts and repair of safety-relevant parts“

Repair has to be carried out by the company OH&S specialist.

Crane scales	Model Serial no.			
Part	Action	Date	Name	Signature

