

Operating instructions Electronic Crane Scales

Logbook Regular maintenance and care

KERN HFM

Version 1.4
2020-04
GB



HFM-BA-e-2014



KERN HFM

Version 1.4 2020-04

Operating instructions / logbook Electronic Suspending Balance

Table of Contents

1.	Technical Data	3
1.1	Dimensions	4
1.2	Nameplate	5
1.3	EC-Declaration of -Conformity	6
2.	General Safety Instructions	7
3.	The crane scales at a glance	10
3.1	Overview	10
3.2	Display	11
3.3	Keyboard	11
3.3.1	Numeric entry	12
3.4	Radio remote control	12
3.5	Sticker	13
4.	Commissioning	14
4.1	Unpacking	14
4.2	Before first use check the dimensions and note them down on the checklist	14
4.3	Rechargeable battery operation	15
4.3.1	Standby mode	16
4.4	Suspending the balance	17
5.	Operation	18
5.1	Safety instructions	18
5.2	Loading the crane scales	19
5.3	Turn on/off	22
5.4	Setting balance to zero	22
5.5	Taring	23
5.6	Weighing	23
5.7	Record weight value (freeze)	23
6.	Menu	24
7.	Adjustment	26
8.	Error messages	27
9.	Cleaning, Repair, Maintenance and Disposal	28
9.1	Cleaning and Disposal	28
9.2	Regular maintenance and care	29
9.3	Checklist „Regular maintenance“	30
9.4	Maintenance table	31
9.5	Drawings of a hook, shackle and crane scale	32
9.6	Inspection cycles	33
9.7	Drawing with “h” dimension	34
10.	Enclosure	35
10.1	Checklist „Enhanced maintenance“ (General revision)	35
10.2	List „spare parts and repair of safety-relevant parts“	36
11.	Instant help	38

1. Technical Data

KERN	HFM 1T0.1	HFM 3T0.5	HFM 5T0.5	HFM 10T1
Readability (d)	0.1 kg	0.5 kg	0.5 kg	1 kg
Weighing range (max)	1 000 kg	3 000 kg	5 000 kg	10 000 kg
Taring range (subtractive)	1 000 kg	3 000 kg	5 000 kg	10 000 kg
Reproducibility	500 g	1 kg	2.5 kg	5 kg
Linearity	±1 kg	±2 kg	±5 kg	±10 kg
Recommended adjustment weight, not added (class)	1 t (M1)	3 t (M1)	5 t (M1)	10 t (M1)
Stabilization time	2 s			
Precision	0.2 % of max.			
Warm-up time	30 min			
Unit	kg			
Allowable ambient temperature	0...+40 °C			
Relative humidity	0 to 80 %, non-condensing			
Supply voltage	220V - 240V AC 50 Hz			
Secondary voltage powerpack	9V, 800 mA			
Rechargeable battery (standard equipment)	6 V, 10 Ah Service life – background illumination ON - 50 h Loading time 14 h			
Display	Digit height 30 mm			
Housing size W x D x H, (mm)	270 x 175 x 200		300 x 190 x 230	
Housing material	Metal, lacquered			
Material hook and shackle	Nickel plated steel			
Net weight (kg)	16	18	23	35
Remote control (standard equipment)	Battery Size 23A (1 x 12V) W x D x H 48 x 16 x 95 mm			

1.1 Dimensions

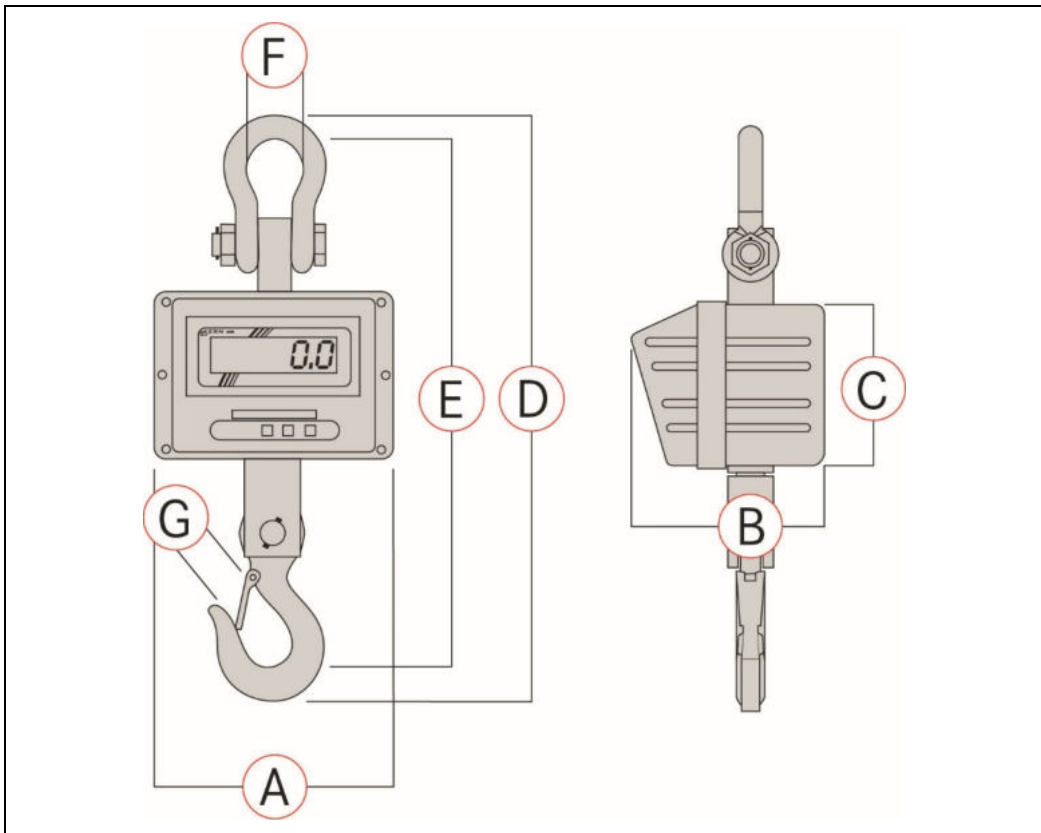

	A	B	C	D	E	F	G
	mm	mm	mm	mm	mm	mm	mm
HFM 1T0.1	270	175	200	610	540	68	40
HFM 3T0.5	270	175	200	610	540	74	40
HFM 5T0.5	300	190	230	730	650	74	55
HFM 10T1	300	190	230	840	750	92	60

1.2 Nameplate



①	KERN Logo
②	Model designation
③	Weighing range [Max]
④	Data for power supply
⑤	Company address
⑥	Readability [d]
⑦	Date of manufacture
⑧	CE mark
⑨	Disposal symbol
⑩	Serial number

1.3 EC-Declaration of -Conformity



KERN & Sohn GmbH
 Ziegelei 1
 72336 Balingen-Frommern
 Germany

www.kern-sohn.com

+0049-[0]7433-9933-0
 +0049-[0]7433-9933-149
 info@kern-sohn.com

Déclaration de conformité UE | EU Declaration of Conformity | EU-Konformitätserklärung

FR Nous déclarons par la présente sous notre entière responsabilité que le produit concerné par cette déclaration respecte les exigences des directives mentionnées ci-après.

EN We hereby declare and assume sole responsibility for the declaration that the product complies with the directives hereinafter.

DE Wir erklären hiermit unter alleiniger Verantwortung, dass das Produkt, auf das sich diese Erklärung bezieht, mit den nachstehenden Richtlinien übereinstimmt.

Type | Type | Typ

N° de série | Serial no. | Seriennr.

HFM 1T0.1
 HFM 3T0.5
 HFM 5T0.5
 HFM 10T1

XXXXXXXXXX

Marquage CE Mark applied CE Kennzeichnung	Directive UE EU directive EU-Richtlinie	Normes Standards Normen
	2006/42/EC (MD)	EN 13155:2003/A2:2009
	2011/65/EU (RoHS)	EN 50581:2012
	2014/30/EU (EMC)	EN 55022:2010 EN 55024:2010 EN 61000-3-3:2013
	2014/35/EU (LVD)	EN 60065:2014 EN 60950-1:2006/A2:2013 EN 61010-1:2010

Date | Date | Datum: 20.04.2016

Lieu de délivrance: 72336 Balingen,
 Place of issue: Germany

Ort der Ausstellung:

Albert Sauter
 KERN & Sohn GmbH

Signature: Directeur Exécutif
 Signature: Managing director
 Signatur: Geschäftsführer



Further language versions you will find online under:

www.kern-sohn.com/ce

2. General Safety Instructions

Duties of the owner-operator

Follow the national accident prevention regulations as well as the working, operating and safety regulations of the owner-operator.

- Observe all safety regulations of the crane manufacturer.
- The balance may only be used for the proposed purpose. Any type of use which is not specified in these operating instructions, will be considered as improper use. The customer is solely responsible for material damage and injury of persons resulting from an improper use, Messrs. KERN & Sohn will not be liable under any circumstance.

Messrs. KERN & Sohn cannot be held liable, if the crane scales are modified or used improperly and if damage is resulting from such use.

- Carry out regular maintenance and care of the crane scales, the crane and the load suspension devices (see chapter 9).
- Log the test result and keep it in the logbook.

Organizational measures

- Only trained and instructed staff may operate the balance.
- Make sure that the operating instructions are kept nearby the operation site of the crane scales.
- Assembly, commissioning and maintenance should only be carried out by trained specialists.
- Repair of safety-relevant pieces may only be carried out by the company OH&S specialist.
- Use original spare parts only.
- All repairs and spare parts must be documented by the service partner (see list, chap. 10.2).
- All maintenance must be documented (see checklist chap. 9.3).
- Load suspending components may only be exchanged as a complete spare parts set. The dimensions of the new components must be noted (see checklist chapter 9.3).

Ambient conditions

- Never operate the crane scales in explosive environment. The serial version is not explosion protected.
- Operate the crane scales only under environmental conditions as specified in these operating instructions (especially in chapter 1 „Technical data“).
- Do not expose the crane scales to strong humidity. Non-permitted condensation (condensation of air humidity on the appliance) may occur if a cold appliance is taken to a considerably warmer environment. In this case, acclimatize the disconnected appliance for ca. 2 hours at room temperature.
- Do not operate the crane scales in corrosive environment.
- Protect the crane scales against high humidity, vapours and dust.
- Avoid extreme heat as well as temperature fluctuations e.g. caused by direct sun light..
- Major display deviations (incorrect weighing results) may be experienced should electromagnetic fields (e.g. due to mobile phones or radio equipment), static electricity accumulations or instable power supply occur. Change location or remove source of interference.

Proper use

The balance you purchased is intended to determine the weighing value of material to be weighed. It is intended to be used as a “non-automatic” balance, i.e. the material to be weighed is suspended on the crane hook only vertically, manually, carefully and without jerks. As soon as a stable weighing value is reached the weighing value can be read.

- Use the crane scales only for lifting and weighing of freely movable loads.
- Danger of injury due to improper use. Not allowed are e.g.:
 - Exceeding the allowed nominal load of crane, crane scales or any type of load attachment devices
 - Conveying persons,
 - Pulling loads over an inclined surface,
 - Tearing-off, pulling or towing loads.
- Modifications or reconstructions of the crane scales or of the crane are not allowed.

Intended use of rotating load hooks

- The rotatable load hook has been provided for a simple and comfortable hooking of the weighed material.
- The rotating function of the load hook under load is out of function. The load on the crane scales must not be swiveled. Any turning movement must be done by a rotatable crane hook.. A loaded crane scales generally must not be rotated. (static loading and unloading of a load).

Improper Use

Do not use balance for dynamic weighing. In the event that small quantities are removed or added to the material to be weighed, incorrect weighing results can be displayed due to the “stability compensation” in the balance. (Example: Slowly draining fluids from a container suspended on the balance.) Do not leave permanent load suspended on the balance. This may damage the measuring system as well as safety-relevant parts.

The balance may only be used according to the described conditions. Other areas of use must be released by KERN in writing.

Warranty

Warranty claims shall be voided in case

- Our conditions in the operation manual are ignored
- The appliance is used outside the described use
- The appliance is modified or opened
- Mechanical damage and damage caused by media, liquids,
- Natural wear and tear
- The appliance is improperly set up or incorrectly electrically connected
- The measuring system is overloaded

Safe working

- Do not stand underneath suspended loads!
- Position the crane in a way that the load is lifted vertically.
- When working with the crane and crane scales wear personal safety equipment (helmet, safety shoes etc.).

Monitoring of Test Resources

In the framework of quality assurance the measuring-related properties of the balance and, if applicable, the testing weight, must be checked regularly. The responsible user must define a suitable interval as well as type and scope of this test. Information is available on KERN's home page (www.kern-sohn.com) with regard to the monitoring of balance test substances and the test weights required for this. In KERN's accredited DKD calibration laboratory test weights and balances may be calibrated (return to the national standard) fast and at moderate cost.

Testing upon acceptance

When receiving the appliance, please check packaging immediately, and the appliance itself when unpacking for possible visible damage.

Initial Commissioning

In order to obtain exact results with the electronic balances, your balance must have reached the operating temperature (see warming up time chap. 1).

During this warming up time the balance must be connected to the power supply (mains, accumulator or battery).

The accuracy of the balance depends on the local acceleration of gravity.

Strictly observe hints in chapter Adjustment.

Check the original dimensions, see chap. 4.2.

Shutdown and storage

- Take off the crane scales from the crane and dismantle all load attachment devices from the crane scales.
- Do not store the crane scales at open air

3. The crane scales at a glance

The crane scales are a multi-purpose and cost-saving solution for overhead weighing applications such as e.g. recycling, metal processing, machine engineering, transport and logistics.

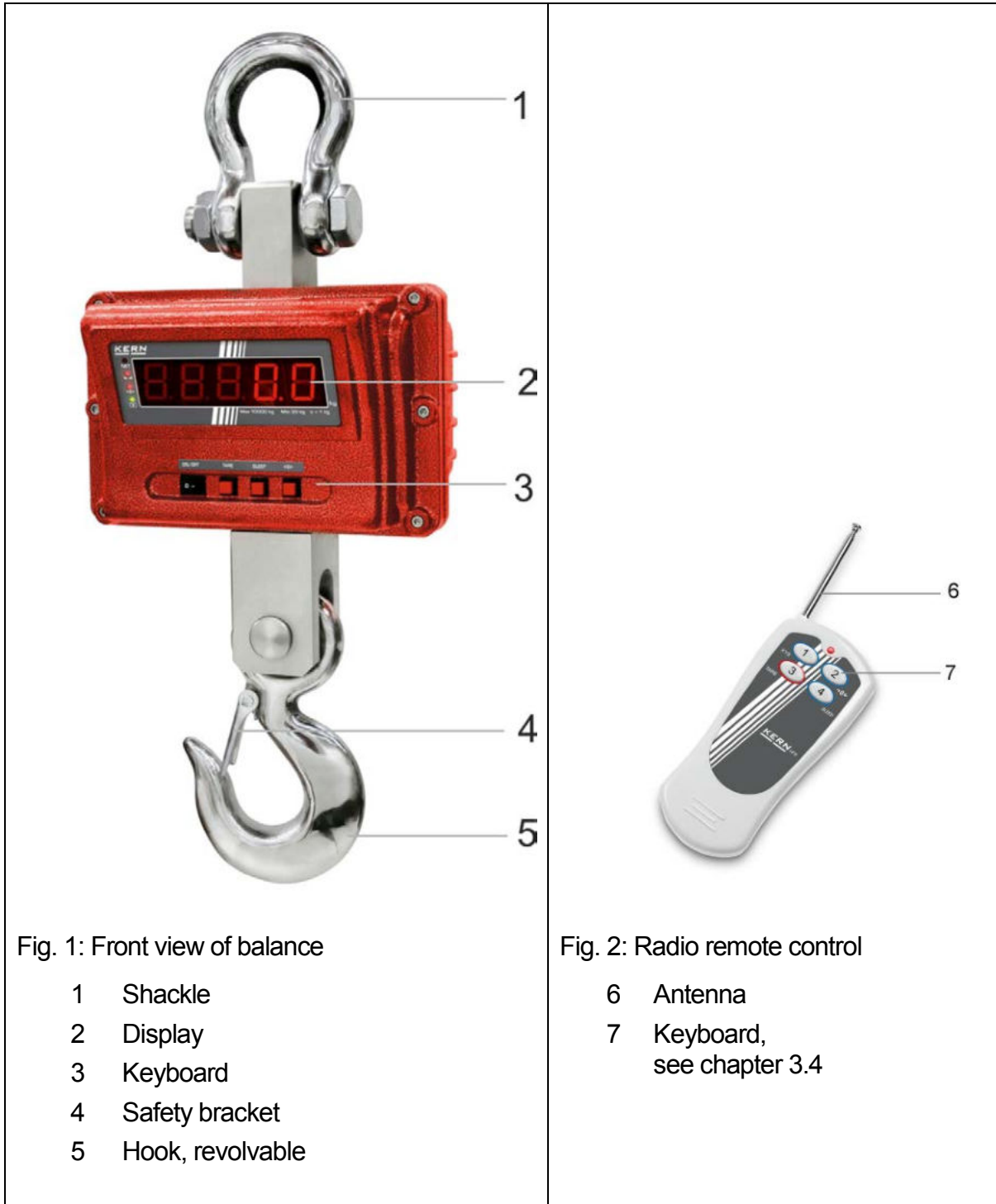

With the radio remote control, operation will be more comfortable yet.

3.1 Overview



3.2 Display



LED	The LED lights up, if
HOLD	the data-hold function is active
	the weight display is stable
→0←	the weight is in the area around the zero point
	when the battery is being recharged

3.3 Keyboard



Button	Description of function
ON/OFF	<ul style="list-style-type: none"> Turn on or off the balance
d= 1/2/5 kg 	<ul style="list-style-type: none"> Modification of readability HFM 1T0.1: 100g⇒200g⇒500g HFM 3T0.5: 500g⇒ 1 kg⇒2 kg HFM 5T0.5: 500g⇒ 1 kg⇒2 kg HFM 10T1: 1 kg ⇒ 2 kg⇒5 kg Scroll forward in menu
HOLD	<ul style="list-style-type: none"> Record weight value (freeze) Exit menu
→0←	<ul style="list-style-type: none"> Taring Zeroing Confirm entry

3.3.1 Numeric entry

Button	Function
d= 1/2/5 kg ↔	Increase flashing digit
HOLD	Digit selection
→0←	Terminate input

3.4 Radio remote control

The balance can be operated by the radio remote control like by a keyboard. All functions (excepted **ON/OFF**) can be selected.

The red LED must light up when any button is pressed. If it does not light up, the batteries in the remote control must be exchanged.

Range on free surface (free of buildings) approx. 20 m.

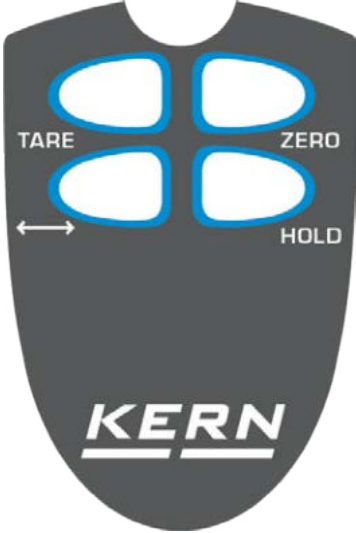
	TARE	Taring
	ZERO	Zeroing
	↔	Modification of readability
	HOLD	Record weight value (freeze)

3.5 Sticker



- ⇒ Do not stand or go under suspended loads.
- ⇒ Do not use on building sites.
- ⇒ Suspended loads have to be observed constantly.



- ⇒ Do not exceed the nominal load of crane scales.

(Example)







- ⇒ The product meets the requirements of the German Equipment and Product Safety Act.

4. Commissioning

Attention: Always observe chapter 2 „General Safety Instructions“!

4.1 Unpacking

 <p>SAFETY INSTRUCTIONS for protection against break</p>	<p>Once delivered and unpacked, crane scales will not be taken back.</p>
	<p>The crane scales have been sealed by Messrs. KERN.</p> <ul style="list-style-type: none">⇒ Shackles and hooks are sealed by Sella tape.⇒ The packaging is also sealed by adhesive tape. <p> Broken seal obliges to purchase.</p> <div style="text-align: center;"><p>Fig.: Seal</p></div>
	<p>Thanks for your comprehension. Your KERN Quality assurance team</p>
 <p>CAUTION Danger for the back!</p>	<p>The crane scales are compact and quite heavy.</p> <ul style="list-style-type: none">⇒ Remove the scales from packaging only with the help of a second person.⇒ Use a lifting device such as a crane or a forklift truck.⇒ Secure the scales that they cannot fall down when they are lifted.

⇒ Make sure that all parts are completely present.



- Crane scales
- Mains adapter
- Remote control
- Operating instructions (logbook)

Only use original packaging for returning.

4.2 Before first use check the dimensions and note them down on the checklist

⇒ Enter the dimensions in the checklist (see chapter 9.3) as per the drawings in chapter 9.5. For that purpose, use appropriate control measures.

4.3 Rechargeable battery operation

  	<p>ATTENTION</p> <ul style="list-style-type: none">⇒ The rechargeable battery and the charging unit match to each other. Only use the delivered mains adapter.⇒ Do not use the crane scales during the loading process.⇒ The rechargeable battery can only be replaced by the same or by a type which has been recommended by the manufacturer.⇒ The rechargeable battery is not protected against all environmental conditions. If the rechargeable battery is exposed to certain environmental influence, the rechargeable battery may set on fire or explode. Persons can be severely injured or material damage may occur.⇒ Protect the rechargeable battery against fire and heat.⇒ Do not bring the rechargeable battery in contact with liquids, chemicals or salts.⇒ Do not expose the rechargeable battery to pressure or microwaves.⇒ The rechargeable battery and the charger may not be modified or manipulated under any circumstances.⇒ Do not use a defective, damaged or deformed rechargeable battery⇒ Do not connect or short-circuit the electrical contacts of the rechargeable battery with metallic objects.⇒ From a damaged rechargeable battery may escape liquids. If the liquid comes into contact with skin or eyes, the skin and the eyes may be irritated.⇒ Ensure the correct polarity when inserting or exchanging the rechargeable battery (see instructions in the rechargeable battery compartment)⇒ The rechargeable battery operation is overridden when a mains adapter is being connected. If weighing more than 48 hours with mains operation, the rechargeable batteries have to be removed! (Danger of overheating).⇒ If the rechargeable battery starts to smell, being hot, changing the colour or being deformed, it must be immediately unplugged from mains supply and from the balance if possible.
---	--

Loading the rechargeable battery:

Before the first use, the rechargeable battery should be charged by connecting it to the mains power cable for at least 24 hours. The operating time of the rechargeable battery is approx. 50 hours.

The capacity of the rechargeable battery will soon be exhausted, when the display begins to flicker. If „bat lo“ appears, the balance will remain operable for approx. 30 minutes more, then it switches off automatically. Connect the power cable as soon as possible to load the rechargeable battery.

During loading the LED display above  informs you about the loading status of the rechargeable battery.

red: Voltage has dropped below prescribed minimum.

green: Rechargeable battery is completely charged

yellow: Capacity of rechargeable battery almost exhausted

When the crane scales are out of operation for a longer period, remove the rechargeable battery.

4.3.1 Standby mode

The crane scales change into the standby mode when any key is pressed or when for 5 minutes (factory setting) no weight change has been measured. Only one segment remains lighting. In order to finish the standby mode, press any key on the keyboard or on the remote control.

Switch-off time selectable after 0, 5, 10, 20, 30 minutes, see chap. „F6 sl“.

4.4 Suspending the balance

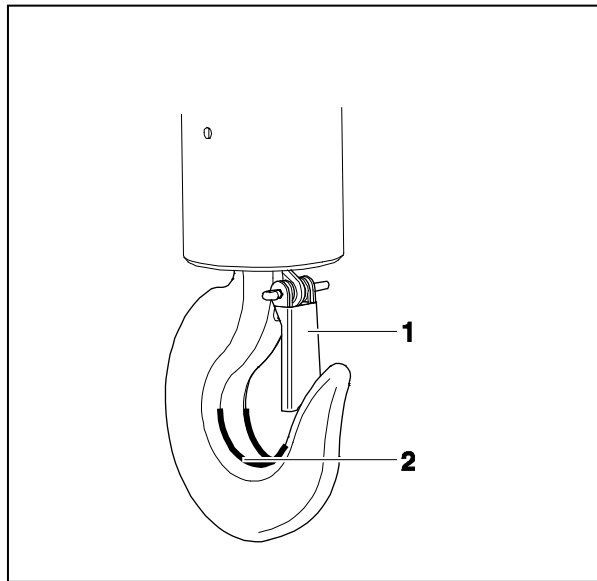

Condition

The crane needs a safety bracket (1) that the unloaded crane scales cannot fall down.

If the safety bracket is missing or damaged, please contact the crane manufacturer in order to receive a hook with this safety equipment.







 **The hook scales can be used solely with a crane equipped with a swivel joint**

⇒ Suspend the crane scales on the lower hook of a crane and close the safety bracket.

The crane scale's upper eyelet should rest in the saddle (2).

5. Operation

5.1 Safety instructions

	 <p>DANGER Risk of injury due to falling loads!</p>
    <p>(Example)</p>	<ul style="list-style-type: none"> ⇒ Always work with particular care according to the general rules for crane operation. ⇒ Check all parts (hook, eyelet, rings, rope slings, cables, chains etc.) for excessive wear or damage ⇒ If faults can be seen on the safety bracket of the hook or if it is missing completely, the scales must not be used. ⇒ Work only with appropriate speed. ⇒ Always avoid vibrations and horizontal forces. Avoid any kind of shock, torsion and oscillating (e.g. caused by inclined suspending). ⇒ Do not use the crane scales for transport of loads ⇒ Do not stand or go under suspended loads. ⇒ Do not use on building sites. ⇒ Suspended loads have to be observed constantly. ⇒ Do not exceed the nominal load of crane, crane scales or any kind of load attachment devices at the crane scales. ⇒ For weighing dangerous goods (e.g molten masses, radioactive materials) the “Dangerous Goods Regulations” are to be regarded!

5.2 Loading the crane scales

For good weighing results observe the following, illustrations see next page:

- ⇒ Only use load attachment devices which guarantee a one-spot suspension and where the scales can be suspended freely.
- ⇒ Do not use too large load attachment devices which do not guarantee any one-spot suspension.
- ⇒ Do not use multiple suspensions.
- ⇒ Do not pull or push the load or the loaded balance.
- ⇒ Do not pull the hook horizontally.

Loading the balance

1. Position the hook of the crane scales over the load.
2. Move downwards the crane scales until the load can be suspended on the hook of the balance. Reduce the speed when the respective height is going to be reached.
3. Suspend the load on the hook. Ensure that the safety bracket is closed. If the load is fixed by slings, ensure that the slings rest completely on the saddle of the balance hook.
4. Lift-off the load slowly.

When the load is fixed by slings, ensure that the load is well balanced on both sides and that the slings are correctly positioned

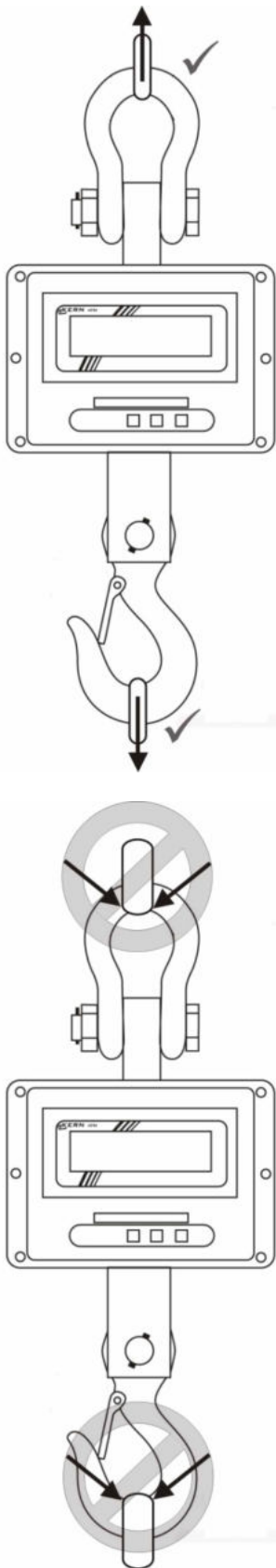

Only use load attachment devices which guarantee a one-point suspension and where the scales can be suspended freely.

Do not use too large load attachment devices which cannot guarantee a one-point suspension.

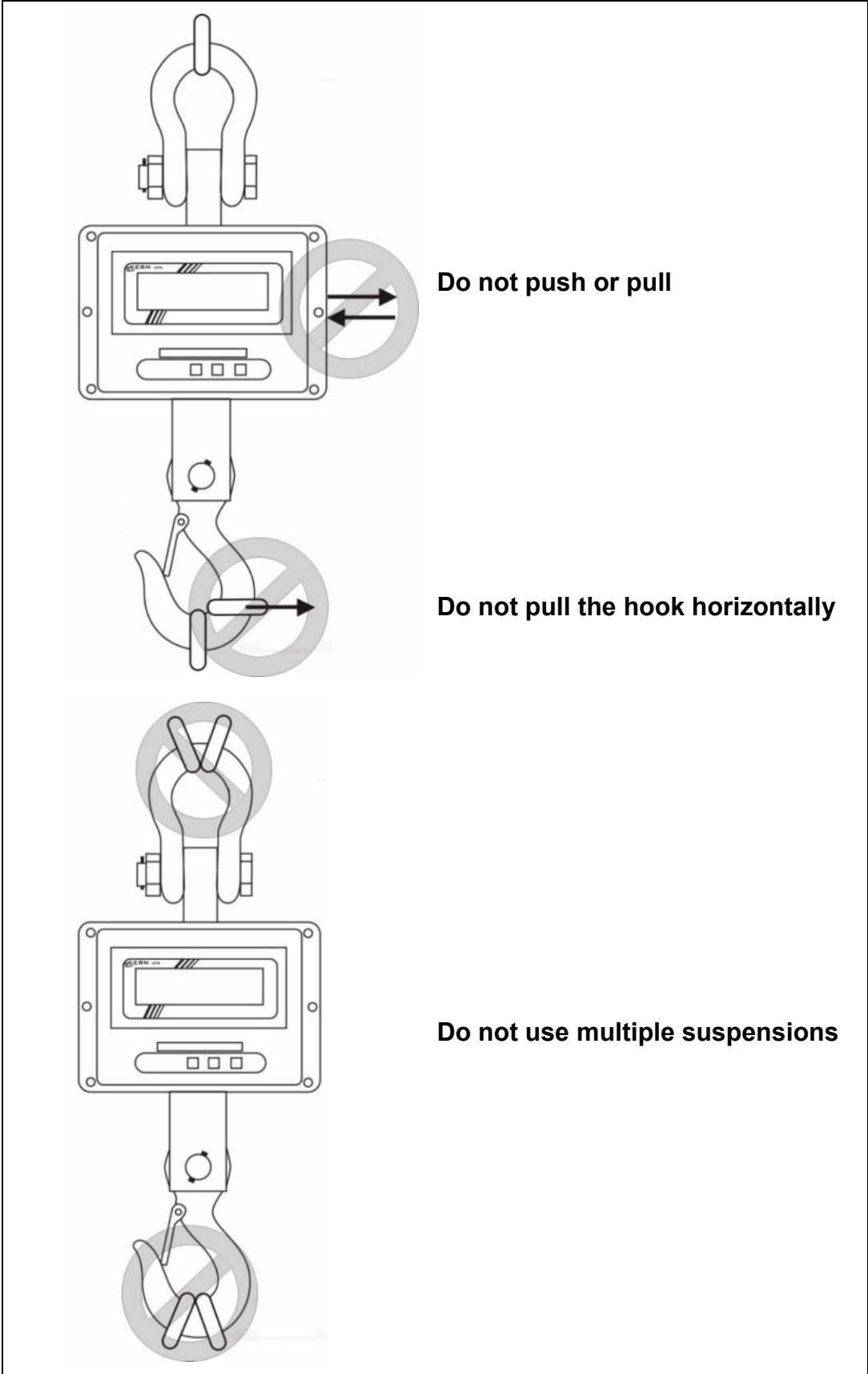

5.3 Turn on/off

Start-up

- ⇒ Press the **ON/OFF** button on the balance keyboard. The display lights up and the balance carries out a selftest. The selftest is completed when the weight value 0 appears on the display.



Switch on only possible at the keyboard of the balance.

Switching Off

- ⇒ Press the **ON/OFF** button on the balance keyboard.

5.4 Setting balance to zero

In order to obtain optimal weighing results, reset to zero the balance before weighing.

Manual

- ⇒ Unload the balance
- ⇒ Press the **ZERO** button.
In the display appears 0 (kg) and the **LED** a lights up.

Automatic

In the menu the amount of the automatic zero point correction can be changed, see chapter 6 / Function „F1 az“.

5.5 Taring

- ⇒ Suspend preload.
Press the **ZERO** button. In the display appears 0 (kg) and the **LED →0←** lights up. The weight of the container is now internally saved.
- ⇒ Weigh the material, the net weight will be indicated.
- ⇒ After removing the preload weight appears as negative display.
- ⇒ To delete the tare value, remove load from crane scales and press the **ZERO** button.

5.6 Weighing

- ⇒ Load the crane scales.
The weight value will be displayed at once. After standstill control the **LED ▽** lights up.



Overload warning

Overloading exceeding the stated maximum load (max) of the balance, minus a possibly existing tare load, must be strictly avoided. This could cause damage to the balance.

Exceeding the maximum load is indicated by the display „--ol-“. Unload balance or reduce preload.

5.7 Record weight value (freeze)

- ⇒ Press the **HOLD** button to „freeze“ or to record the current weight value. It remains displayed until it is deleted. The **LED HOLD** lights up
- ⇒ In order to delete the "frozen" or the recorded weight, press the **HOLD** button. The **LED HOLD** extinguishes.

6. Menu

Navigation in the menu:

Call function	<p>⇒ Switch on the balance and during the selftest press the ZERO and the $d=1/2/5\text{ kg}$ button at the same time. „P1 - - -“ is displayed.</p> <p>⇒ Enter password:</p> <p>or select standard password „0000“ with HOLD number, increase the flashing number using $d=1/2/5\text{ kg}$</p> <p>or personal password, see function F8 ci</p> <p>⇒ Confirm with ZERO button. The first function „F0 di“ is displayed.</p>
Select function	<p>⇒ The $d=1/2/5\text{ kg}$ button allows to select the individual functions one after the other.</p>
Select setting	<p>⇒ Confirm the selected function by the ZERO button. The current setting will be displayed.</p>
Change settings	<p>⇒ Use the $d=1/2/5\text{ kg}$ button to switch over into the available settings.</p>
Confirm setting	<p>⇒ Press the ZERO button, the balance returns into the menu.</p>
Exit menu / Return to weighing mode	<p>⇒ Press the HOLD button.</p>

Overview:

Function	Available settings	Description																																				
F0 di Modification of readability	Low	Modifications may only be carried out by a specialist with competent knowledge.																																				
	High*																																					
	cap		<table border="1" style="width: 100%; text-align: center;"> <thead> <tr> <th></th> <th colspan="3">d (low) d= 1/2/5 kg ↔</th> <th colspan="3">d (high) d= 1/2/5 kg ↔</th> </tr> </thead> <tbody> <tr> <td>1 t</td> <td>2kg</td> <td>1kg</td> <td>500g</td> <td>500g</td> <td>200g</td> <td>100g</td> </tr> <tr> <td>3 t</td> <td>10kg</td> <td>5kg</td> <td>2kg</td> <td>2kg</td> <td>1kg</td> <td>500g</td> </tr> <tr> <td>5 t</td> <td>10kg</td> <td>5kg</td> <td>2kg</td> <td>2kg</td> <td>1kg</td> <td>500g</td> </tr> <tr> <td>10 t</td> <td>20kg</td> <td>10kg</td> <td>5kg</td> <td>5kg</td> <td>2kg</td> <td>1kg</td> </tr> </tbody> </table>		d (low) d= 1/2/5 kg ↔			d (high) d= 1/2/5 kg ↔			1 t	2kg	1kg	500g	500g	200g	100g	3 t	10kg	5kg	2kg	2kg	1kg	500g	5 t	10kg	5kg	2kg	2kg	1kg	500g	10 t	20kg	10kg	5kg	5kg	2kg	1kg
			d (low) d= 1/2/5 kg ↔			d (high) d= 1/2/5 kg ↔																																
	1 t		2kg	1kg	500g	500g	200g	100g																														
	3 t		10kg	5kg	2kg	2kg	1kg	500g																														
5 t	10kg	5kg	2kg	2kg	1kg	500g																																
10 t	20kg	10kg	5kg	5kg	2kg	1kg																																
F1 az Automatic zero point correction (zero tracking)	AZn 0 AZn 1* AZn 2 AZn 3	0.5 d 1 d 2 d 4 d																																				
F2 bt	Not documented																																					
F3 sp	Not documented																																					
F4 ip	Internal A/D converter value																																					
F5 ut	Not documented																																					
F6 sl Standby mode see chap. 4.3.1	SLP 0 SLP 1* SLP 2 SLP 3 SLP 4	Standby mode switched off Standby mode after 5 minutes Standby mode after 10 minutes Standby mode after 20 minutes Standby mode after 30 minutes																																				
F7 gv	Not documented																																					
F8 ci Password entry	In „P1- - “ display increase the flashing number using d= 1/2/5 kg ↔, select number using HOLD . Confirm entry by ZERO button.																																					
F9 CL	Adjustment, see chapter 7																																					

* = default setting

7. Adjustment

- ⇒ Switch-off balance and attach a carrying help if necessary.
- ⇒ Switch-on balance with attached carrying help and during the selftest press the **ZERO** and the $d = 1/2/5 \text{ kg}$ button at the same time. „P1 - - -“ is displayed.

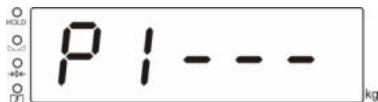

- ⇒ Use the number keys to enter password:

or

select standard password „0000“ with **HOLD** number, increase the flashing number using $d = 1/2/5 \text{ kg}$

or

personal password, see function F8 ci

- ⇒ Confirm with **ZERO** button, the first function „F0 di“ is displayed.

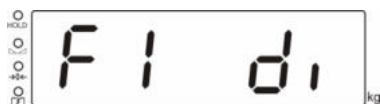

- ⇒ Press the $d = 1/2/5 \text{ kg}$ button repeatedly until „F9 CAL“ will be displayed.



- ⇒ Press the **ZERO** button, „UnLD“ will be displayed.
- ⇒ Unload the balance and wait until the LED  lights up.



- ⇒ Press the **ZERO** button, the currently set adjustment weight is displayed.
- ⇒ In order to change, select the number to be changed using the **HOLD** button and set the desired value using the $d = 1/2/5 \text{ kg}$ button, the respective active digit flashes.
- ⇒ Confirm by the **ZERO** button, „LoAd“ will be displayed.
- ⇒ Attach the adjustment weight and wait until the LED  lights up.

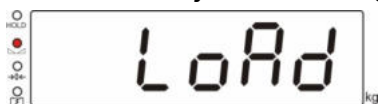

- ⇒ Press the **ZERO** button.
- ⇒ After successful adjustment the balance carries out a selftest, then it automatically returns to weighing mode.
An adjusting error or incorrect adjusting weight will be indicated by the error message; repeat adjustment procedure

8. Error messages

Error message	Description	Possible causes
--oI-	Maximum load exceeded	⇒ Reduce load ⇒ Check whether the balance has been damaged
Err 5	Keyboard error	⇒ Improper operation of the balance
Err 6	Value outside the A/D changer range	⇒ Weighing plate not installed ⇒ Damaged weighing cell ⇒ Damaged electronics
Ba lo	Capacity of rechargeable battery exhausted	⇒ Recharge battery

Should other error messages occur, switch balance off and then on again. If the error message remains inform manufacturer.

9. Cleaning, Repair, Maintenance and Disposal

	Prior to any maintenance, cleaning and repair work disconnect the device from the operating voltage.
---	--

 Danger	Risk of injury and risk of material damage! The crane scales are part of a hoisting device! For a safe operation please observe the following: <ul style="list-style-type: none">⇒ Have carried out a regular maintenance by trained specialized staff⇒ Carry out regular maintenance and care, see chapter 9.2⇒ Have the parts exchanged only by trained specialized staff.⇒ If there arose discrepancies with the safety checklist, the balance must not more be put into operation.⇒ Do not repair the crane scales by yourself. The repairs can be carried out solely by the company OH&S specialist.
--	--

9.1 Cleaning and Disposal

 CAUTION	Damage on the crane scales! <ul style="list-style-type: none">⇒ Do not use any industrial solutions or chemicals
---	---

- ⇒ Clean the keyboard and the display with a soft cloth soaked in mild window cleaning agent.
- ⇒ Disposal of packaging and appliance must be carried out by operator according to valid national or regional law of the location where the appliance is used.

9.2 Regular maintenance and care

- ▲ Regular inspections and maintenance works should be carried out at intervals stipulated in chapter 9.6.
- ▲ The regular 3-month maintenance may only be carried out by an expert with competent knowledge of working with crane scales. Thereby the national regulations for prevention of accidents as well as the working, operation and safety regulations of the owner-operator.
- ▲ Always use validated control measures/feeler gauges for checking.
- ▲ Regular technical inspections (every 12 months) can be carried out solely by the trained personnel (company OH&S specialist).
- ▲ The results of the maintenance must be written down in the checklist (chap. 9.3).
- ▲ The additional results of the extended maintenance have to be entered in the checklist (chapter 10.1).
- ▲ The replaced spare parts also must be entered, (chapter 10.2)

Regular maintenance:

<p>Initial start-up, every 3 months</p>	<ul style="list-style-type: none"> ▪ Enter and verify all dimensions, see the “Checklist”, chap. 9.3 ▪ Check the shackle or the eyelet for wear and tear, such as e.g. plastic deformation, mechanical damage (unevenness), notches, striation, cracks, corrosion, thread damage and torsions. ▪ Visual inspection and checking the function of the articulated joint ▪ Check the application of the safety bracket on the hook, moreover check for fault and correct function ▪ For balances of big construction size: Check that the split pin and the nut on the shackle are not loose <p>If a dimension exceeds the admitted deviation from the original dimension (see checklist, chap. 9.3) or if other discrepancies have been found, the balance must be repaired at once by trained specialized staff ((company OH&S specialist). Never do repair it by yourself! Take balance out of operation immediately!</p> <p>All repairs and spare parts must be documented by the service partner (see list, chap. 10.2).</p>
<p>Every 12 months</p>	<ul style="list-style-type: none"> ▪ All load-transferring parts must be verified and documented by personnel qualified for extended maintenance (see the “Checklist”, chap. 10.1).

Hint

During the revision watch out for wear and tear according to the following drawings (see chap. 9.5)

9.3 Checklist „Regular maintenance“

i Additional information on the maintenance works can be found in the table below (see chapter 9.4) and in figures in chapter 9.5.

	Shackle					Hook									Date	Inspector
	a	b	c	Wear (see grey fields)	Cotter pin and nut	d	e	f	g	h	Angle α	Wear (see grey fields)	Detent	Articulated joint		
Max. acceptable deviation	5%	0%	5%	No deformations or cracks	Well fixed	10 %	5%	5%	5%	± 1 mm	10°	No deformation s or cracks	Correct operation	Check function		
Dimensions before first use																
3 months																
6 months																
9 months																
12 months																

bold letters = Those technical inspections must be carried out by the company OH&S specialist.

9.4 Maintenance table

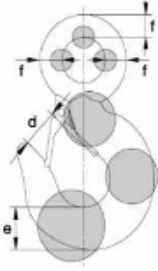
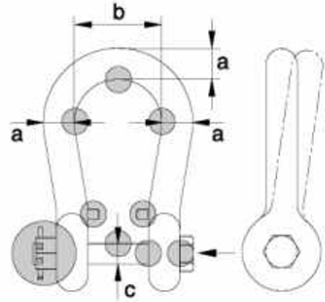
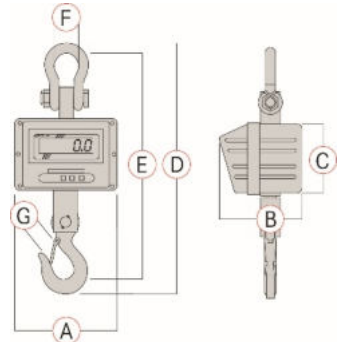
Part	Drawing	Component	Inspection	Limits
Hook		Detent	Inspection concerning operation and damage	No damage is acceptable, operation must be ensured.
		Articulated joint	Check function	Correct operation
		Eye and hook	Inspection concerning dimensions and damage	As per Table 9.3
Shackle		Locking bolt	If it is not loose	It must not be loose.
		Shackle	Inspection concerning dimensions and damage	As per Table 9.3
		Cotter pin + nut	Inspection concerning damage and positioning	Correct positioning as per Table 9.3
Crane scale		Screw connections	Loose	It must not be loose.
		Crevice between the hook and the enclosure	Dimension check	As per Table 9.3

9.5 Drawings of a hook, shackle and crane scale

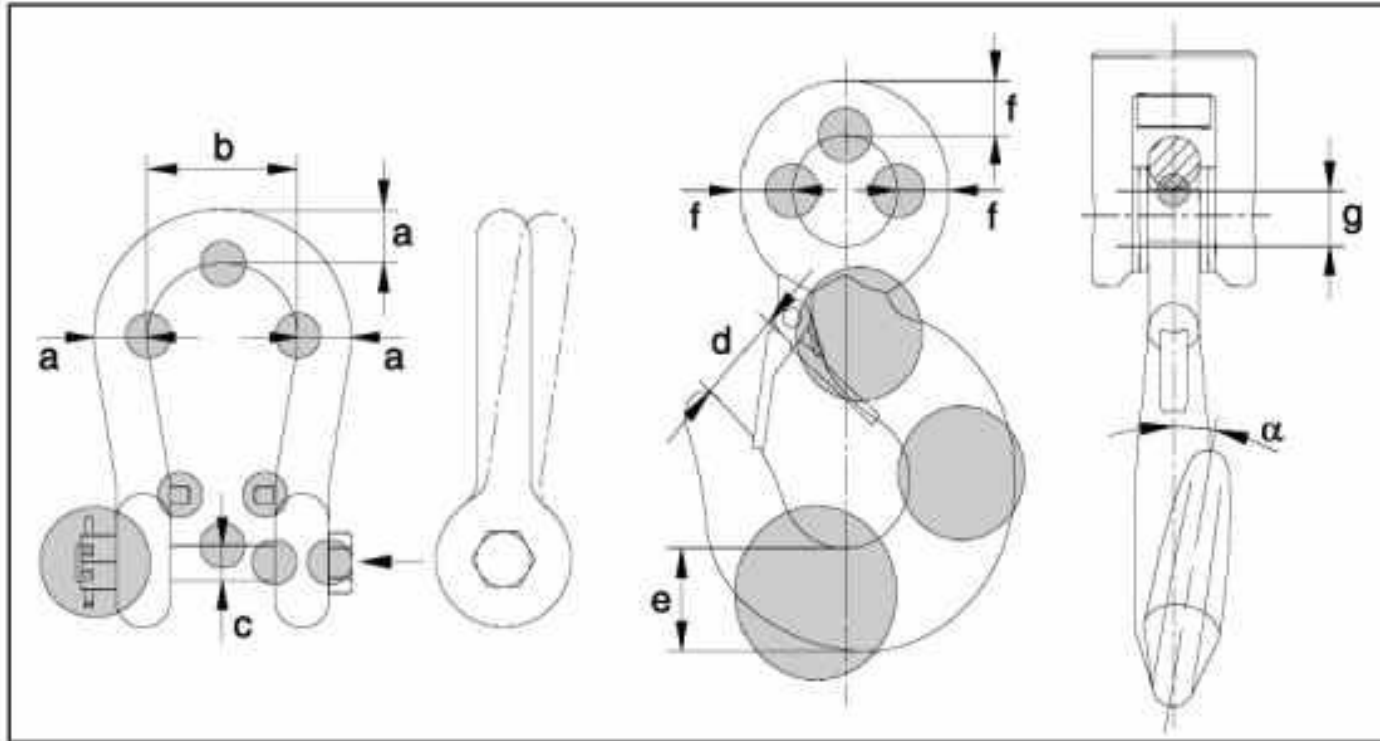

9.6 Inspection cycles

Inspection	Every day	Every 7 days	Every 3 months	Every 12 months
Presence of all crane scale parts	<input checked="" type="checkbox"/>			
Visual inspection for damage	<input checked="" type="checkbox"/>			
Visual inspection and operation inspection of the hook detent	<input checked="" type="checkbox"/>			
Visual inspection and checking the function of the articulated joint	<input checked="" type="checkbox"/>			
Inspection of the shackle cotter pin and nut	<input checked="" type="checkbox"/>			
Impurities		<input checked="" type="checkbox"/>		
Marking inspection (legible nameplate)		<input checked="" type="checkbox"/>		
Inspection of all dimensions as per the checklist 9.3			<input checked="" type="checkbox"/>	
Extended maintenance by the company OH&S specialist, see chapter 10.1				<input checked="" type="checkbox"/>

9.7 Drawing with “h” dimension

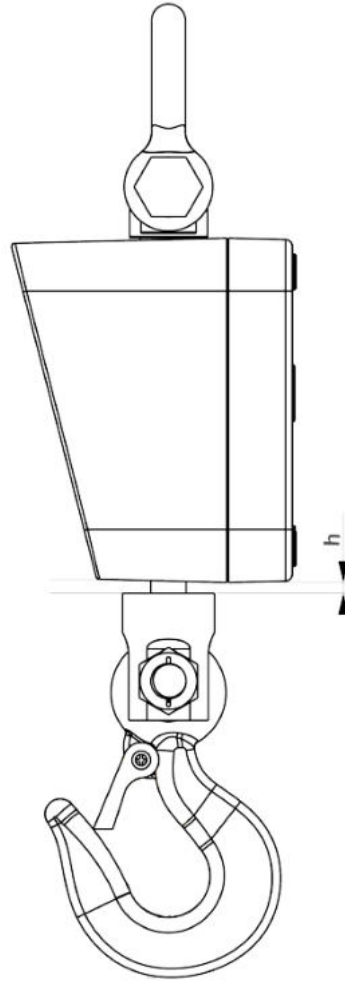

10. Enclosure

10.1 Checklist „Enhanced maintenance“ (General revision)

The enhanced maintenance has to be carried out by the company OH&S specialist.

Crane scales		Model Serial no.				
Interval	Hooks	Shackle	Screwed connections	Date	Name	Signature
12 months						

Crane scales		Model			Serial no.	
Part	Action	Date	Name	Signature		

11. Instant help

Possible causes of errors:

In case of an error in the program process, briefly turn off the balance and disconnect from power supply. The weighing process must then be restarted from the beginning.

Fault	Possible cause
The displayed weight does not glow.	<ul style="list-style-type: none">• The balance is not switched on.
The balance cannot be switched on	<ul style="list-style-type: none">• Load/replace the rechargeable battery• On/Off button defective• On/Off button not correctly actuated
The display does not react to load change	<ul style="list-style-type: none">• Load cell defective• Load cell cable defective
Loading display does not glow during loading	<ul style="list-style-type: none">• Power supply unit defective• Power supply unit not correctly connected
The displayed weight is permanently changing	<ul style="list-style-type: none">• Vibrations on the hook• Suspended load does not stand still• Load cell defective
The weighing result is obviously incorrect	<ul style="list-style-type: none">• The balance has not been reset to zero before weighing• The adjustment does not match with the installation place or has been misadjusted.• Wrong weighing unit selected
The desired weighing unit cannot be called by UNIT key.	<ul style="list-style-type: none">• Unit was not activated beforehand.
Error message „-ol-“	<ul style="list-style-type: none">• Maximum load of the balance exceeded
The menu settings cannot be changed.	<ul style="list-style-type: none">• The menu is locked Remove the menu lock.
The remote control does not work	<ul style="list-style-type: none">• Batteries empty, insert new batteries• Too much distance between balance and remote control• Obstacles block the reception