

# Bourdon tube pressure gauge, stainless steel

## High overload safety up to the 4 times the full scale value

### Models 232.36, 233.36, safety version

WIKA data sheet PM 02.15



for further approvals,  
see page 5

#### Applications

- For occasional short-duration overpressure loads
- For gaseous and liquid aggressive media that are not highly viscous or crystallising, also in aggressive environments
- Oil and gas industry, chemical and petrochemical industry, power plants, mining, on-/offshore, environmental technology, machine building and general plant construction

#### Special features

- Overpressure range is indicated completely on scale
- Safety version with solid baffle wall (Solidfront) designed in compliance with the requirements of EN 837-1 and ASME B40.100
- With case filling (model 233.36) for applications with high dynamic pressure loads and vibrations
- Measuring ranges from 0 ... 0.6 bis 0 ... 40 bar [0 ... 10 to 0 ... 600 psi]



**Bourdon tube pressure gauge, model 232.36, NS 100 [4"]**

#### Description

This high-quality Bourdon tube pressure gauge has been designed specifically for the display of occasional overpressure loads. The instrument can withstand up to 4 times the full scale value for short periods, without damage.

The use of high-quality stainless steel materials and the robust design are geared to applications in the chemical and process engineering industries. Thus the instrument is suitable for liquid and gaseous media, also in aggressive environments.

Measuring ranges from 0 ... 0.6 to 0 ... 40 bar [0 ... 10 to 0 ... 600 psi] are available for a wide variety of applications.

WIKA manufactures and qualifies the pressure gauge in accordance with the standards EN 837-1 and ASME B40.100. This safety version is made up of a non-splintering window, a solid baffle wall between measuring system and dial and a blow-out back. In the event of a failure, the operator is protected at the front side, as media or components can only be ejected via the back of the case.

For harsh operating conditions (e.g. vibrations), all instruments are also available with an optional liquid filling.

## Specifications

Basic information	
<b>Standard</b>	<ul style="list-style-type: none"> <li>■ EN 837-1</li> <li>■ ASME B40.100</li> </ul> <p>For information on the "Selection, installation, handling and operation of pressure gauges", see Technical information IN 00.05.</p>
<b>Further version</b>	For oxygen, oil- and grease-free
<b>Nominal size (NS)</b>	<ul style="list-style-type: none"> <li>■ Ø 100 mm [4"]</li> <li>■ Ø 160 mm [6"]</li> </ul>
<b>Connection location</b>	Lower mount (radial)
<b>Window</b>	Laminated safety glass
<b>Case</b>	
Design	<p>Safety level "S3" per EN 837-1</p> <p>With solid baffle wall and blow-out back</p> <p>Measuring ranges ≤ 0 ... 16 bar [≤ 0 ... 300 psi] with compensating valve to vent and reseal case</p>
Material	<ul style="list-style-type: none"> <li>■ Stainless steel 1.4301 (304)</li> <li>■ Stainless steel 1.4571 (316 Ti)</li> </ul>
<b>Ring</b>	Bayonet ring, stainless steel
<b>Mounting</b>	<ul style="list-style-type: none"> <li>■ Without</li> <li>■ Panel mounting flange, stainless steel</li> <li>■ Panel mounting flange, polished stainless steel</li> <li>■ Surface mounting lugs on the back, stainless steel</li> </ul>
<b>Case filling (model 233.36)</b>	<ul style="list-style-type: none"> <li>■ Without</li> <li>■ Glycerine</li> <li>■ Glycerine-water mixture for NS 100 [4"] and 160 [6"] with measuring range ≤ 0 ... 2.5 bar [≤ 0 ... 40 psi] or for NS 63 [2 ½"] with measuring range ≤ 0 ... 4 bar [≤ 0 ... 60 psi]</li> <li>■ Silicone oil</li> </ul>
<b>Movement</b>	Stainless steel

Measuring element	
<b>Type of measuring element</b>	Bourdon tube, C-type or helical type
<b>Material</b>	Stainless steel 1.4404 (316L)
<b>Leak tightness</b>	<ul style="list-style-type: none"> <li>■ Helium tested, leakage rate: &lt;math&gt; &lt; 5 \cdot 10^{-3}&lt;/math&gt; mbar l/s</li> <li>■ Helium tested, leakage rate: &lt;math&gt; &lt; 1 \cdot 10^{-6}&lt;/math&gt; mbar l/s</li> </ul>

Accuracy specifications	
<b>Accuracy class</b>	
EN 837-1	Class 1.0 referred to the measuring span
ASME B40.100	±1 % of measuring span (grade 1A)
<b>Temperature error</b>	On deviation from the reference conditions at the measuring system: ≤ ±0.4 % per 10 °C [≤ ±0.4 % per 18 °F] of full scale value
<b>Reference conditions</b>	
Ambient temperature	+20 °C [68 °F]

## Measuring ranges

Measuring range	Overload safety
<b>bar</b>	
0 ... 0.6	2.5
0 ... 1	4
0 ... 1.6	6
0 ... 2.5	10
0 ... 4	16
0 ... 6	25
0 ... 10	40
0 ... 16	60
0 ... 25	80
0 ... 40	100

Measuring range	Overload safety
<b>kPa</b>	
0 ... 60	25
0 ... 100	40
0 ... 160	60
0 ... 250	100
0 ... 400	160
0 ... 600	250
0 ... 1,000	400
0 ... 1,600	600
0 ... 2,500	800
0 ... 4,000	1,000

Measuring range	Overload safety
<b>psi</b>	
0 ... 10	35
0 ... 15	60
0 ... 60	230
0 ... 150	580
0 ... 250	930
0 ... 400	1,280
0 ... 600	1,500

Measuring range	Overload safety
<b>MPa</b>	
0 ... 0.06	0.25
0 ... 0.1	0.4
0 ... 0.16	0.6
0 ... 0.25	1
0 ... 0.4	1.6
0 ... 0.6	2.5
0 ... 1	4
0 ... 1.6	6
0 ... 2.5	8
0 ... 4.0	10

## Vacuum and +/- measuring ranges

Measuring range	Overload safety
<b>bar</b>	
-1 ... 0	3
-1 ... +0.6	3
-1 ... +1.5	6
-1 ... +3	16
-1 ... +5	25
-1 ... +9	40
-1 ... +15	60
-1 ... +24	80

Measuring range	Overload safety
<b>kPa</b>	
-100 ... 0	300
-100 ... +60	300
-100 ... +150	600
-100 ... +300	1,500
-100 ... +400	2,400
-100 ... +900	4,000
-100 ... +1,500	6,000
-100 ... +2,400	8,000

Measuring range	Overload safety
<b>psi</b>	
-30 inHg ... 0	45
-30 inHg ... +15	45
-30 inHg ... +30	100
-30 inHg ... +60	250
-30 inHg ... +100	400
-30 inHg ... +160	600
-30 inHg ... +200	800
-30 inHg ... +300	1,000

Measuring range	Overload safety
<b>MPa</b>	
-0.1 ... 0	0.3
-0.1 ... +0.06	0.3
-0.1 ... +0.15	0.6
-0.1 ... +0.3	1.5
-0.1 ... +0.5	2.5
-0.1 ... +0.9	4
-0.1 ... +1.5	6
-0.1 ... +2.4	8

Further details on: Measuring ranges	
<b>Unit</b>	<ul style="list-style-type: none"> <li>■ bar</li> <li>■ psi</li> <li>■ kg/cm<sup>2</sup></li> <li>■ kPa</li> <li>■ MPa</li> </ul>
<b>Vacuum resistance</b>	<ul style="list-style-type: none"> <li>■ Without</li> <li>■ Vacuum-resistant to -1 bar</li> </ul>
<b>Dial</b>	
Scale colour	Black
Material	Aluminium
Customer-specific version	Other scales or customer-specific dials, e.g. with red mark, circular arcs or circular sectors, on request
<b>Pointer</b>	
Instrument pointer	Aluminium, black
Mark pointer/drag pointer	<ul style="list-style-type: none"> <li>■ Without</li> <li>■ Red mark pointer on dial, fixed</li> <li>■ Red mark pointer on window, adjustable</li> <li>■ Red drag pointer on window, adjustable</li> </ul>
<b>Pointer stop pin</b>	<ul style="list-style-type: none"> <li>■ Without</li> <li>■ At 6 o'clock</li> </ul>

Process connection	
<b>Standard</b>	<ul style="list-style-type: none"> <li>■ EN 837-1</li> <li>■ ISO 7</li> <li>■ ANSI/B1.20.1</li> </ul>
<b>Size</b>	
EN 837-1	<ul style="list-style-type: none"> <li>■ G ½ B, male thread</li> <li>■ M12 x 1.5, male thread</li> <li>■ M20 x 1.5, male thread</li> </ul>
ISO 7	<ul style="list-style-type: none"> <li>■ R ½, male thread</li> </ul>
ANSI/B1.20.1	<ul style="list-style-type: none"> <li>■ ½ NPT, male thread</li> </ul>
<b>Restrictor</b>	<ul style="list-style-type: none"> <li>■ Without</li> <li>■ Ø 0.6 mm [0.024"], stainless steel</li> </ul>
<b>Material (wetted)</b>	
Process connection	Stainless steel 1.4404 (316L)
Bourdon tube	Stainless steel 1.4404 (316L)





Other process connections on request

Operating conditions	
<b>Medium temperature</b>	
Unfilled instruments	-40 ... +200 °C [-40 ... +392 °F]
Instruments with glycerine filling	-20 ... +100 °C [-4 ... +212 °F]
Instruments with silicone oil filling	-40 ... +100 °C [-40 ... +212 °F]
<b>Ambient temperature</b>	
Unfilled instruments or with silicone oil filling	-40 ... +60 °C [-40 ... +140 °F]
Instruments with glycerine filling	-20 ... +60 °C [-4 ... +140 °F]
<b>Pressure limitation</b>	
Steady	End value of measuring range
Fluctuating	0.9 x end value of measuring range
Short time	The overload safety depends on the measuring range, → See page 3
<b>Ingress protection per IEC/EN 60529</b>	<ul style="list-style-type: none"> <li>■ IP65</li> <li>■ IP66</li> </ul>

## Approvals

Logo	Description	Country
-	<b>CRN</b> Safety (e.g. electr. safety, overpressure, ...)	Canada

### Optional approvals

Logo	Description	Country
	<b>EU declaration of conformity</b> ATEX directive Hazardous areas - Ex h Gas II 2G Ex h IIC T6 ... T1 Gb X Dust II 2D Ex h IIIC T85°C ... T450°C Db X	European Union
	<b>EAC</b> Hazardous areas	Eurasian Economic Community
	<b>PAC Russia</b> Metrology, measurement technology	Russia
	<b>PAC Kazakhstan</b> Metrology, measurement technology	Kazakhstan
-	<b>MChS</b> Permission for commissioning	Kazakhstan
	<b>PAC Belarus</b> Metrology, measurement technology	Belarus
-	<b>PAC Ukraine</b> Metrology, measurement technology	Ukraine
-	<b>CPA</b> Metrology, measurement technology	China

## Manufacturer's information and certificates

Logo	Description
-	Pressure equipment directive (PED) for maximum allowable pressure PS ≤ 200 bar
-	Suitability of wetted materials for drinking water in accordance with the European 4MS initiative

## Certificates (option)

Certificates	
<b>Certificates</b>	<ul style="list-style-type: none"> <li>■ 2.2 test report per EN 10204 (e.g. state-of-the-art manufacturing, indication accuracy)</li> <li>■ 3.1 inspection certificate per EN 10204 (e.g. material proof for wetted metal parts, indication accuracy)</li> <li>■ PCA calibration certificate, traceable and accredited in accordance with ISO/IEC 17025</li> <li>■ Calibration certificate by a national accreditation body, traceable and accredited in accordance with ISO/IEC 17025 on request</li> </ul>
<b>Recommended calibration interval</b>	1 year (dependent on conditions of use)

→ For approvals and certificates, see website

## Dimensions in mm [in]

### Lower mount (radial)

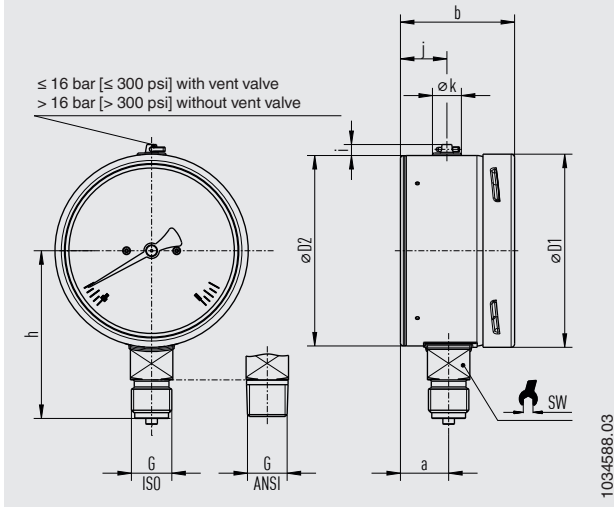

### Process connection with thread per EN 837-1

NS	G	Dimensions in mm [in]								
		h ±1 [0.04]	a	b	D1	D2	i	j	k	SW
100 [4"]	G ½ B	87 [3.43]	25 [0.98]	59.5 [2.34]	100 [3.94]	100 [3.94]	6 [0.24]	24 [0.94]	15 [0.59]	22 [0.87]
	M12 x 1.5	80 [3.15]								
	M20 x 1.5	87 [3.43]								
160 [6"]	G ½ B	118 [4.65]	27 [1.06] <sup>1)</sup>	65 [2.56] <sup>2)</sup>	159 [6.26]	159 [6.26]	6 [0.24]	18.5 [0.73]	15 [0.59]	22 [0.87]
	M12 x 1.5	111 [4.37]								
	M20 x 1.5	118 [4.65]								

### Process connection with thread per ISO 7









NS	G	Dimensions in mm [in]								
		h ±1 [0.04]	a	b	D1	D2	i	j	k	SW
100 [4"]	R ½	86 [3.39]	25 [0.98]	59.5 [2.34]	100 [3.94]	100 [3.94]	6 [0.24]	24 [0.94]	15 [0.59]	22 [0.87]
160 [6"]	R ½	117 [4.61]	27 [1.06]	65 [2.56]	159 [6.26]	159 [6.26]	6 [0.24]	18.5 [0.73]	15 [0.59]	22 [0.87]

### Process connection with thread per ANSI/B1.20.1

NS	G	Dimensions in mm [in]								
		h ±1 [0.04]	a	b	D1	D2	i	j	k	SW
100 [4"]	½ NPT	86 [3.39]	25 [0.98]	59.5 [2.34]	100 [3.94]	100 [3.94]	6 [0.24]	24 [0.94]	15 [0.59]	22 [0.87]
160 [6"]	½ NPT	117 [4.61]	27 [1.06]	65 [2.56]	159 [6.26]	159 [6.26]	6 [0.24]	18.5 [0.73]	15 [0.59]	22 [0.87]

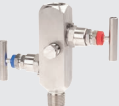
NS	Weight	
	Model 232.36	Model 233.36
100 [4"]	approx. 0.65 kg [1.43 lb]	approx. 1.08 kg [2.38 lb]
160 [6"]	approx. 1.30 kg [2.87 lb]	approx. 2.34 kg [4.94 lb]

## Accessories and spare parts for models 232.36 and 233.36

Model	Description
	<b>910.17</b> Sealings → See data sheet AC 09.08
	<b>910.15</b> Syphons → See data sheet AC 09.06
	<b>910.13</b> Overpressure protector → See data sheet AC 09.04
	<b>IV10, IV11</b> Needle valve and multiport valve → See data sheet AC 09.22
	<b>IV20, IV21</b> Block-and-bleed valve → See data sheet AC 09.19
	<b>IVM</b> Monoflange, process and instrument version → See data sheet AC 09.17
	<b>BV</b> Ball valve, process and instrument version → See data sheet AC 09.28
	<b>IBF2, IBF3</b> Monoblock with flange connection → See data sheet AC 09.25

### Ordering information

Model / Nominal size / Measuring range / Process connection / Connection location / Options

© 02/1995 WIKA Alexander Wiegand SE & Co. KG, all rights reserved.  
 The specifications given in this document represent the state of engineering at the time of publishing.  
 We reserve the right to make modifications to the specifications and materials.

WIKA data sheet PM 02.15 · 03/2022

Page 7 of 7

Your WIKA Sales Partner



**ICS Schneider Messtechnik GmbH**  
 Briesestrasse 59  
 D-16562 Hohen Neuendorf / OT Bergfelde  
 Tel.: +49 3303 5040-66  
 Fax: +49 3303 5040-68  
 E-Mail: info@ics-schneider.de



**WIKAL Alexander Wiegand SE & Co. KG**  
 Alexander-Wiegand-Straße 30  
 63911 Klingenberg/Germany  
 Tel. +49 9372 132-0  
 Fax +49 9372 132-406  
 info@wika.de  
 www.wika.de