

SIEMENS

SITRANS P

Pressure transmitter SITRANS P320/P420 with PROFIBUS PA and FOUNDATION Fieldbus

Operating Instructions

7MF03.1 (SITRANS P320 with PROFIBUS PA)
7MF03.2 (SITRANS P320 with FOUNDATION Fieldbus)
7MF04.1 (SITRANS P420 with PROFIBUS PA)
7MF04.2 (SITRANS P420 with FOUNDATION Fieldbus)

09/2021

A5E50228627-AB

Getting started	1
Introduction	2
Safety information	3
Description	4
Installing/mounting	5
Connecting	6
Operating	7
Commissioning	8
Parameter assignment	9
Service and maintenance	10
Diagnostics and troubleshooting	11
Technical data	12
Dimension drawings	13
Remote operation	A
PROFIBUS communication	B
FOUNDATION Fieldbus communication	C
Product documentation and support	D
Sealing plug / thread adapter	E
Abbreviations	F

Legal information

Warning notice system

This manual contains notices you have to observe in order to ensure your personal safety, as well as to prevent damage to property. The notices referring to your personal safety are highlighted in the manual by a safety alert symbol, notices referring only to property damage have no safety alert symbol. These notices shown below are graded according to the degree of danger.

 DANGER
indicates that death or severe personal injury will result if proper precautions are not taken.

 WARNING
indicates that death or severe personal injury may result if proper precautions are not taken.

 CAUTION
indicates that minor personal injury can result if proper precautions are not taken.

NOTICE
indicates that property damage can result if proper precautions are not taken.

If more than one degree of danger is present, the warning notice representing the highest degree of danger will be used. A notice warning of injury to persons with a safety alert symbol may also include a warning relating to property damage.

Qualified Personnel

The product/system described in this documentation may be operated only by **personnel qualified** for the specific task in accordance with the relevant documentation, in particular its warning notices and safety instructions. Qualified personnel are those who, based on their training and experience, are capable of identifying risks and avoiding potential hazards when working with these products/systems.

Proper use of Siemens products

Note the following:

 WARNING
Siemens products may only be used for the applications described in the catalog and in the relevant technical documentation. If products and components from other manufacturers are used, these must be recommended or approved by Siemens. Proper transport, storage, installation, assembly, commissioning, operation and maintenance are required to ensure that the products operate safely and without any problems. The permissible ambient conditions must be complied with. The information in the relevant documentation must be observed.

Trademarks

All names identified by ® are registered trademarks of Siemens AG. The remaining trademarks in this publication may be trademarks whose use by third parties for their own purposes could violate the rights of the owner.

Disclaimer of Liability

We have reviewed the contents of this publication to ensure consistency with the hardware and software described. Since variance cannot be precluded entirely, we cannot guarantee full consistency. However, the information in this publication is reviewed regularly and any necessary corrections are included in subsequent editions.

Table of contents

1	Getting started	11
2	Introduction.....	13
2.1	Purpose of this documentation	13
2.2	Scope of validity of this document.....	13
2.3	Document history	13
2.4	Product compatibility	14
2.5	Checking the consignment.....	14
2.6	Security information	14
2.7	Transportation and storage	15
2.8	Notes on warranty	15
3	Safety information.....	17
3.1	Precondition for use.....	17
3.1.1	Warning symbols on the device	17
3.1.2	Laws and directives	17
3.1.3	Conformity with European directives	18
3.1.4	Classification according to the pressure equipment directive	18
3.2	Requirements for special applications.....	19
3.3	Use in hazardous areas.....	19
4	Description.....	23
4.1	Area of application.....	23
4.2	Structure	25
4.3	Nameplate layout.....	26
4.4	Tag plate.....	28
4.5	Functional principle	28
4.5.1	Electronics	29
4.5.2	Measuring cell	30
4.5.2.1	Functional principle of the measuring cell	30
4.5.2.2	Measuring cell for gauge pressure	31
4.5.2.3	Measuring cell for gauge pressure, front-flush membrane.....	32
4.5.2.4	Measuring cell for absolute pressure from the gauge pressure series	33
4.5.2.5	Measuring cell for absolute pressure, front-flush membrane	34
4.5.2.6	Measuring cell for absolute pressure from the differential pressure series	35
4.5.2.7	Measuring cell for differential pressure and flow rate	36
4.5.2.8	Measuring cell for level	37
4.6	System configuration	38

5	Installing/mounting	39
5.1	Basic safety instructions	39
5.1.1	Installation location requirements	42
5.1.1.1	Devices with marine approval.....	42
5.1.2	Proper mounting.....	43
5.2	Installation (except level)	43
5.3	Securing the device with mounting bracket	45
5.4	Mounting hygienic version	47
5.5	Installation (level)	47
5.5.1	Mounting on the container	49
5.6	Installation with remote seal	51
5.6.1	Remote seal with capillary line	53
5.7	Installing electrical connections and cable entries.....	58
5.8	Rotating the display	58
5.9	Rotating the enclosure	60
5.10	Insert jumper	61
5.11	Removing	63
6	Connecting	65
6.1	Basic safety instructions	65
6.1.1	Incorrect measured values with incorrect grounding.....	67
6.2	Connecting the device	68
6.2.1	Opening the device.....	68
6.2.2	Connecting the device	69
6.2.3	Closing the device.....	70
6.3	Connect the Han cable socket to the cable.....	71
6.4	Connect M12 cable socket to the cable.....	72
6.5	Switching on the supply voltage.....	73
7	Operating.....	75
7.1	Buttons.....	75
7.2	Operating the device with display.....	75
7.2.1	Navigating in the views	75
7.2.2	Measurement view	76
7.2.2.1	Display of measured values	77
7.2.2.2	Navigating in the measurement view	77
7.2.3	Parameter view	78
7.2.3.1	List of parameters on the display	78
7.2.3.2	Navigating in the parameter view.....	79
7.2.4	Edit view.....	80
7.2.4.1	Changing parameter values.....	80
7.2.5	Device status display	81
7.3	Locking the device	81

7.3.1	Enable write protection with jumper (only with PROFIBUS PA).....	82
7.3.2	Enable user PIN.....	82
7.3.3	Enabling button lock.....	83
7.3.4	Write protection with "Write lock" parameter (FOUNDATION Fieldbus).....	84
8	Commissioning	85
8.1	Basic safety instructions.....	85
8.2	Commissioning the device (PROFIBUS PA).....	86
8.3	Commissioning the device (FOUNDATION Fieldbus).....	87
8.4	Application examples.....	88
8.4.1	Gauge pressure, absolute pressure from differential pressure series, and absolute pressure from gauge pressure series.....	88
8.4.1.1	Commissioning in gaseous environments.....	88
8.4.1.2	Commissioning with steam or liquid.....	90
8.4.2	Differential pressure and flow rate.....	91
8.4.2.1	Commissioning in gaseous environments.....	91
8.4.2.2	Commissioning for liquids.....	92
8.4.2.3	Commissioning with vapor.....	94
9	Parameter assignment.....	97
9.1	Parameter assignment over device with display.....	97
9.1.1	Pressure units [01].....	97
9.1.1.1	Display of the pressure units.....	98
9.1.1.2	Setting the pressure units.....	99
9.1.2	Lower input scaling point [02].....	100
9.1.3	Upper input scaling point [03].....	100
9.1.4	Damping value [04].....	100
9.1.4.1	Set damping value.....	101
9.1.5	Application [05].....	101
9.1.5.1	Set application.....	101
9.1.5.2	Operating principle.....	102
9.1.5.3	Level measurement.....	102
9.1.5.4	Volume and mass flow measurements.....	104
9.1.5.5	Volume measurement.....	106
9.1.5.6	Characteristic curves.....	108
9.1.6	Application point [06].....	108
9.1.7	Zero point adjustment [07].....	109
9.1.7.1	Adjusting zero point (gauge pressure).....	109
9.1.7.2	Adjusting the zero point (differential pressure).....	110
9.1.7.3	Adjusting zero point (absolute pressure).....	111
9.1.8	Units [16].....	112
9.1.8.1	Level units [16].....	112
9.1.8.2	Volume units [16].....	112
9.1.8.3	Volume flow units [16].....	113
9.1.8.4	Mass flow units [16].....	114
9.1.9	Temperature units [17].....	115
9.1.10	Lower output scaling point [18].....	115
9.1.11	Upper output scaling point [19].....	116
9.1.12	Low flow cut-off [20].....	117
9.1.13	Vessel dimension A [21].....	117
9.1.14	Vessel dimension L [22].....	118

9.1.15	Button lock [23]	118
9.1.15.1	Enabling button lock	119
9.1.15.2	Disabling button lock	119
9.1.16	Change user PIN [24]	120
9.1.17	Recovery ID [25]	121
9.1.17.1	Display Recovery ID	121
9.1.18	PIN recovery [26]	121
9.1.18.1	Recovering the user PIN	122
9.1.19	User PIN [27]	123
9.1.19.1	Enable user PIN	123
9.1.19.2	Disable user PIN	124
9.1.20	Display test [30]	124
9.1.21	Start view [32]	125
9.1.22	Pressure reference [33]	125
9.1.23	Reset [35]	126
9.1.23.1	Reset parameters	126
9.1.23.2	Reset to sensor calibration	126
9.1.23.3	Restore ordered configuration	126
9.1.23.4	Restore factory settings	126
9.1.24	FW version [37]	127
9.1.25	Configuration change counter [38]	127
9.1.26	Slave address [40]	127
9.1.27	GSD SELECT [41]	127
9.1.27.1	Startup parameters	128
9.1.28	Active GSD (General Station Description) [42]	129
9.2	Parameter assignment over remote operation	130
9.2.1	Introduction	130
9.2.2	Quick start	130
9.2.3	Identification	130
9.2.4	Totalizer	131
9.2.5	Simulation	132
9.2.5.1	Simulate constant pressure values	132
9.2.5.2	Simulate ramp function	133
9.2.5.3	Simulate diagnostics	133
9.2.6	Customized characteristic curve	134
9.2.6.1	Introduction	134
9.2.6.2	Custom unit parameter	134
9.2.6.3	Set customized characteristic curve	135
9.2.7	Sensor calibration	135
9.2.8	Diagnostics functions	137
9.2.8.1	Limit monitoring and event counter	137
9.2.8.2	Trend log	141
9.2.8.3	Operating hours counter	142
10	Service and maintenance	143
10.1	Basic safety instructions	143
10.2	Cleaning	144
10.2.1	Servicing the remote seal measuring system	144
10.3	Maintenance and repair work	144
10.3.1	Defining the maintenance interval	145
10.3.2	Checking the seals	146

10.3.3	Check cable glands	146
10.4	Replacing spare parts	147
10.4.1	Replacing electrical connections and cable entries	147
10.4.2	Replacing the display	147
10.4.2.1	Removing the display	147
10.4.2.2	Installing the display	148
10.4.3	Replacing the termination board	149
10.5	Return procedure	149
11	Diagnostics and troubleshooting.....	151
11.1	Device status symbols	151
11.2	Diagnostic messages	153
11.3	FOUNDATION Fieldbus	159
11.4	Troubleshooting	161
12	Technical data	163
12.1	Input	163
12.1.1	Gauge pressure	163
12.1.2	Gauge pressure with front-flush diaphragm	164
12.1.3	Gauge pressure from the differential pressure series	165
12.1.4	Absolute pressure from the gauge pressure series	166
12.1.5	Absolute pressure with front-flush diaphragm	167
12.1.6	Absolute pressure from the differential pressure series	168
12.1.7	Differential pressure and flow	169
12.1.8	Level	171
12.2	Measuring accuracy of SITRANS P320	172
12.2.1	Reference conditions	172
12.2.2	Effect of auxiliary power supply	172
12.2.3	Gauge pressure	172
12.2.4	Gauge pressure with front-flush diaphragm	173
12.2.5	Gauge pressure from the differential pressure series	174
12.2.6	Absolute pressure from the gauge pressure series	176
12.2.7	Absolute pressure with front-flush diaphragm	176
12.2.8	Absolute pressure from the differential pressure series	177
12.2.9	Differential pressure and flow	178
12.2.10	Level	181
12.3	Measuring accuracy of SITRANS P420	182
12.3.1	Reference conditions	182
12.3.2	Effect of auxiliary power supply	183
12.3.3	Gauge pressure	183
12.3.4	Gauge pressure with front-flush diaphragm	184
12.3.5	Gauge pressure from the differential pressure series	185
12.3.6	Absolute pressure from the gauge pressure series	186
12.3.7	Absolute pressure with front-flush diaphragm	187
12.3.8	Absolute pressure from the differential pressure series	188
12.3.9	Differential pressure and flow	189
12.3.10	Level	192
12.4	Operating conditions	193

12.5	Vibration resistance	198
12.6	Construction	199
12.7	Torques	203
12.8	Display, keys and auxiliary power	204
12.9	Certificates and approvals.....	204
13	Dimension drawings	211
13.1	SITRANS P320/P420 for gauge pressure and absolute pressure from the gauge pressure series.....	211
13.2	SITRANS P320/P420 for differential pressure, gauge pressure, flow and absolute pressure from the differential pressure series.....	213
13.3	SITRANS P 320/P420 for level	215
13.4	SITRANS P320/P420 (front-flush)	216
13.4.1	Note 3A and EHDG	217
13.4.2	Connections as per EN and ASME	217
13.4.3	F&B and pharma flange.....	218
13.4.4	PMC Style	220
13.4.5	Special connections	221
A	Remote operation	223
A.1	SIMATIC PDM	223
A.1.1	Overview SIMATIC PDM	223
A.1.2	Check SIMATIC PDM version	223
A.1.3	Updating the Electronic Device Description (EDD)	224
B	PROFIBUS communication	225
B.1	PROFIBUS assembly guidelines	225
C	FOUNDATION Fieldbus communication.....	227
C.1	Resource Block.....	227
C.2	Pressure Transducer Block	227
C.3	Analog input function block	228
C.4	Proportional Integral Derivative (PID) Block.....	229
D	Product documentation and support	233
D.1	Product documentation	233
D.2	Technical support.....	234
E	Sealing plug / thread adapter	235
E.1	Intended use of accessory part.....	235
E.2	Safety instructions for accessory part	235
E.3	Technical specifications of accessory part	236
E.4	Dimensional drawings for accessory part.....	237

F	Abbreviations.....	239
	Index.....	241

Getting started

Before you commission the device, observe the following safety notes:

- General safety information (Page 17)
- Basic safety information: Installing/mounting (Page 39)
- Basic safety information: Connecting (Page 65)
- Basic safety information: Commissioning (Page 85)

Read the entire device manual in order to achieve the optimum performance of the device.

Procedure

1. Mount the device.
Installation (level) (Page 47)
Installation (except level) (Page 43)
2. Connect the device.
Connecting the device (Page 69)
3. Switch on the supply voltage.
Switching on the supply voltage (Page 73)
4. To operate the buttons, open the button cover:

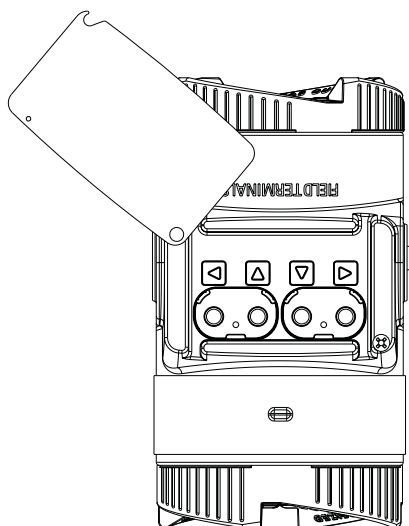

Figure 1-1 Top view

Navigating in the views (Page 75)

5. Commission the device.
Commissioning the device (PROFIBUS PA) (Page 86)
Commissioning the device (FOUNDATION Fieldbus) (Page 87)

6. If you want to change the factory settings, configure the device using the local or the remote operation.
 - List of parameters on the display (Page 78)
 - Parameter assignment over remote operation (Page 130)
7. Lock the device if required.
 - Locking the device (Page 81)

See also

Diagnostic messages (Page 153)

Introduction

2.1 Purpose of this documentation

These instructions contain all information required to commission and use the device. Read the instructions carefully prior to installation and commissioning. In order to use the device correctly, first review its principle of operation.

The instructions are aimed at persons mechanically installing the device, connecting it electronically, configuring the parameters and commissioning it, as well as service and maintenance engineers.

2.2 Scope of validity of this document

Variant	SITRANS P320	SITRANS P420
Gauge pressure	7MF030.	7MF040.
Gauge pressure from the differential pressure series	7MF031.	7MF041.
Absolute pressure from the gauge pressure series	7MF032.	7MF042.
Absolute pressure from the differential pressure series	7MF033.	7MF043.
Differential pressure and flow rate, MAWP 160 bar (2320 psi)	7MF034.	7MF044.
Differential pressure and flow rate, MAWP 420 bar (6092 psi)	7MF035.	7MF045.
Level	7MF036.	7MF046.

Article number of the variants

2.3 Document history

The overview below summarizes the most important changes in the documentation when compared to the previous edition.

Edition	Note
09/2021	New variant of the device with FOUNDATION Fieldbus
01/2021	First edition

2.4 Product compatibility

The following table describes the compatibility between the edition of this manual, the device revision, the engineering system and the associated EDD.

Edition	Comments	Device revision	Compatible version of device integration package	
09/2021	New type of communication	PROFIBUS PA FW: 1.00.05 or higher HW: 1.00.00 or higher	SIMATIC PDM V9.0 or higher DTM Pactware V4.2 or higher	EDD: 1.00.00 or higher
		FOUNDATION Fieldbus FW: 1.00.08 or higher HW: 1.00.00 or higher	SIMATIC PDM V9.1 or higher DTM Pactware V4.3 or higher AMS Trex Device Communicator	
01/2021	Manual revised	PROFIBUS PA FW: 1.00.05 or higher HW: 1.00.00 or higher	SIMATIC PDM V9.0 or higher DTM Pactware V4.2 or higher	EDD: 1.00.00 or higher

2.5 Checking the consignment

1. Check the packaging and the delivered items for visible damages.
2. Report any claims for damages immediately to the shipping company.
3. Retain damaged parts for clarification.
4. Check the scope of delivery by comparing your order to the shipping documents for correctness and completeness.



WARNING

Using a damaged or incomplete device

Risk of explosion in hazardous areas.

- Do not use damaged or incomplete devices.

2.6 Security information

Siemens provides products and solutions with industrial security functions that support the secure operation of plants, systems, machines, and networks.

In order to protect plants, systems, machines and networks against cyber threats, it is necessary to implement – and continuously maintain – a holistic, state-of-the-art industrial security concept. Siemens' products and solutions form one element of such a concept.

Customers are responsible for preventing unauthorized access to their plants, systems, machines and networks. These systems, machines and components should only be connected to the enterprise network or the Internet if and only to the extent necessary and with appropriate security measures (firewalls and/or network segmentation) in place.

You can find more information on protective measures in the area of industrial security by visiting:

<https://www.siemens.com/industrialsecurity>.

Siemens' products and solutions undergo continuous development to make them more secure. Siemens strongly recommends performing product updates as soon as they are available and using only the latest product versions. Use of product versions that are no longer supported, and failure to apply latest updates may increase customer's exposure to cyber threats.

To stay informed about product updates, subscribe to the Siemens Industrial Security RSS Feed under

<https://www.siemens.com/industrialsecurity>.

Download any type of software files (available updates such as EDD) only from secure sources (e.g. SIOS Portal or SIEMENS page of product family).

2.7 Transportation and storage

To guarantee sufficient protection during transport and storage, observe the following:

- Keep the original packaging for subsequent transportation.
- Devices/replacement parts should be returned in their original packaging.
- If the original packaging is no longer available, ensure that all shipments are properly packaged to provide sufficient protection during transport. Siemens cannot assume liability for any costs associated with transportation damages.

NOTICE

Insufficient protection during storage

The packaging only provides limited protection against moisture and infiltration.

- Provide additional packaging as necessary.

Special conditions for storage and transportation of the device are listed in Technical data (Page 163).

2.8 Notes on warranty

The contents of this manual shall not become part of or modify any prior or existing agreement, commitment or legal relationship. The sales contract contains all obligations on the part of Siemens as well as the complete and solely applicable warranty conditions. Any statements regarding device versions described in the manual do not create new warranties or modify the existing warranty.

The content reflects the technical status at the time of publishing. Siemens reserves the right to make technical changes in the course of further development.

Safety information

3.1 Precondition for use

This device left the factory in good working condition. In order to maintain this status and to ensure safe operation of the device, observe these instructions and all the specifications relevant to safety.

Observe the information and symbols on the device. Do not remove any information or symbols from the device. Always keep the information and symbols in a completely legible state.

3.1.1 Warning symbols on the device

Symbol	Explanation
	Consult operating instructions

3.1.2 Laws and directives

Observe the safety rules, provisions and laws applicable in your country during connection, assembly and operation. These include, for example:

- National Electrical Code (NEC - NFPA 70) (USA)
- Canadian Electrical Code (CEC) (Canada)

Further provisions for hazardous area applications are for example:

- IEC 60079-14 (international)
- EN 60079-14 (EU)

3.1 Precondition for use

3.1.3 Conformity with European directives

The CE mark on the device is a sign of conformity with the following European directives:

Electromagnetic compatibility EMC 2014/30/EU	Directive of the European Parliament and of the Council on the harmonization of the laws of the Member States relating to electromagnetic compatibility
Atmosphère explosible ATEX 2014/34/EU	Directive of the European Parliament and the Council on the harmonization of the laws of the Member States concerning equipment and protective systems intended for use in potentially explosive atmospheres
Pressure Equipment Directive PED 2014/68/EU	Directive of the European Parliament and of the Council on the harmonization of the laws of the Member States relating to the making available on the market of pressure equipment

The directives applied can be found in the EU declaration of conformity for the associated device.

3.1.4 Classification according to the pressure equipment directive

- For gases of fluid group 1 and liquids of fluid group 1; complies with requirements of article 4, paragraph 3 (sound engineering practice)
- Only for devices with MAWP 420 bar (6092 psi):
For gases of Fluid Group 1 and liquids of Fluid Group 1; fulfills the basic safety requirements as per article 3, Para 1 (appendix 1); classified as category III, module H conformity evaluation by TÜV Nord

 WARNING
Improper device modifications Risk to personnel, system and environment can result from modifications to the device, particularly in hazardous areas. <ul style="list-style-type: none">• Only carry out modifications that are described in the instructions for the device. Failure to observe this requirement cancels the manufacturer's warranty and the product approvals.

3.2 Requirements for special applications

Due to the large number of possible applications, each detail of the described device versions for each possible scenario during commissioning, operation, maintenance or operation in systems cannot be considered in the instructions. If you need additional information not covered by these instructions, contact your local Siemens office or company representative.

Note

Operation under special ambient conditions

We highly recommend that you contact your Siemens representative or our application department before you operate the device under special ambient conditions as can be encountered in nuclear power plants or when the device is used for research and development purposes.



DANGER

Using equipment with approval-related restrictions

Risk of explosion, damage to property due to operating conditions not in conformity with the approval (e.g. temperature and pressure limits exceeded)

- Take note of the approval restrictions before using the device. You can find the information on this in the current certificates.

See also

Product documentation (Page 233)

3.3 Use in hazardous areas

Qualified personnel for hazardous area applications

Persons who install, connect, commission, operate, and service the device in a hazardous area must have the following specific qualifications:

- They are authorized, trained or instructed in operating and maintaining devices and systems according to the safety regulations for electrical circuits, high pressures, aggressive, and hazardous media.
- They are authorized, trained, or instructed in carrying out work on electrical circuits for hazardous systems.
- They are trained or instructed in maintenance and use of appropriate safety equipment according to the pertinent safety regulations.

 WARNING
Use in hazardous area
Risk of explosion.
<ul style="list-style-type: none">• Only use equipment that is approved for use in the intended hazardous area and labeled accordingly.• Do not use devices that have been operated outside the conditions specified for hazardous areas. If you have used the device outside the conditions for hazardous areas, make all Ex markings unrecognizable on the nameplate.

See also

Technical data (Page 163)

 WARNING
Loss of safety of device with type of protection "Intrinsic safety Ex i"
If the device or its components have already been operated in non-intrinsically safe circuits or the electrical specifications have not been observed, the safety of the device is no longer ensured for use in hazardous areas. There is a risk of explosion.
<ul style="list-style-type: none">• Connect the device with type of protection "Intrinsic safety" solely to an intrinsically safe circuit.• Observe the specifications for the electrical data on the certificate and/or in Technical data (Page 163).

 WARNING
Use of incorrect device parts in potentially explosive environments
Devices and their associated device parts are either approved for different types of protection or they do not have explosion protection. There is a risk of explosion if device parts (such as covers) are used for devices with explosion protection that are not expressly suited for this type of protection. If you do not adhere to these guidelines, the test certificates and the manufacturer warranty will become null and void.
<ul style="list-style-type: none">• Use only device parts that have been approved for the respective type of protection in the potentially explosive environment. Covers that are not suited for the "explosion-proof" type of protection are identified as such by a notice label attached to the inside of the cover with "Not Ex d Not SIL".• Do not swap device parts unless the manufacturer specifically ensures compatibility of these parts.

 **WARNING****Use of the device with intrinsic safety "Ex i" type of protection in a polluted environment.**

If you open the device on the display side, there is a risk of pollution. The safety of the device for use in hazardous areas is therefore no longer guaranteed. There is a danger of explosion.

- Ensure that the environment is clean before rotating or replacing the display.

 **WARNING****Incorrect material for the diaphragm in Zone 0**

Risk of explosion in the hazardous area. If operated with intrinsically safe supply devices of category "ib" or devices of the flameproof enclosure version "Ex d" and simultaneous use in Zone 0, pressure transmitter explosion protection depends on the tightness of the diaphragm.

- Ensure that the material used for the diaphragm is suitable for the process medium. Refer to the information in the section "Technical data (Page 163)".

Description

4.1 Area of application

Depending on the variant, the pressure transmitter measures corrosive, non-corrosive and hazardous gases, vapors and liquids.

You can use the pressure transmitter for the following measuring tasks:

- Gauge pressure
- Absolute pressure
- Differential pressure

With the appropriate configuration and the necessary add-on parts (e.g. limiters and remote seals), you can also use the pressure transmitter for the following measuring tasks:

- Level
- Volume flow
- Mass flow
- Volume
- Customized characteristic curve

The output signal for all measuring tasks is a direct current of 4 to 20 mA or a process-based, digital signal (e.g. with PROFIBUS PA).

You can install the "intrinsically-safe" or "flameproof enclosure" version of the pressure transmitter in hazardous areas. The devices have a test certification and comply with the corresponding directives.

Pressure transmitters with remote seals of various shapes can be provided for special applications. For example, measuring high-viscosity substances is a special application.

Operate the device in accordance with the specifications in section Technical data (Page 163).

Gauge pressure

This version measures aggressive, non-aggressive and hazardous gases, vapors and liquids.

There are two series: a "differential pressure" series and a "gauge pressure" series. The "differential pressure" series is distinguished by a high overload capability.

4.1 Area of application

Differential pressure and flow

This version measures corrosive, non-corrosive and hazardous gases, vapors and liquids. You can use this version for the following measurement types:

- Differential pressure, e.g. effective differential pressure
- Gauge pressure, suitable for small positive or negative pressure value
- Together with a primary element

Level

This version with mounting flange measures the level of non-corrosive, corrosive and hazardous liquids in open and closed containers.

The nominal size of the mounting flange is DN 40 to DN 125 or 1 1/2" to 5".

The negative connection of the measuring cell is kept open when measuring the level of open containers. This measurement is referred to as "measurement against atmosphere". The negative connection is normally connected with the container when measuring the level of closed containers. This means the static pressure is present at both ends.

Wetted parts are made of various materials, depending on corrosion resistance requirements.

Absolute pressure

This version measures the absolute pressure of aggressive, non-aggressive and hazardous gases, vapors and liquids.

There are two series: a "differential pressure" series and a "gauge pressure" series. The "differential pressure" series is distinguished by a high overload capability.

4.2 Structure

Depending on the customer-specific order, the device comprises different parts.

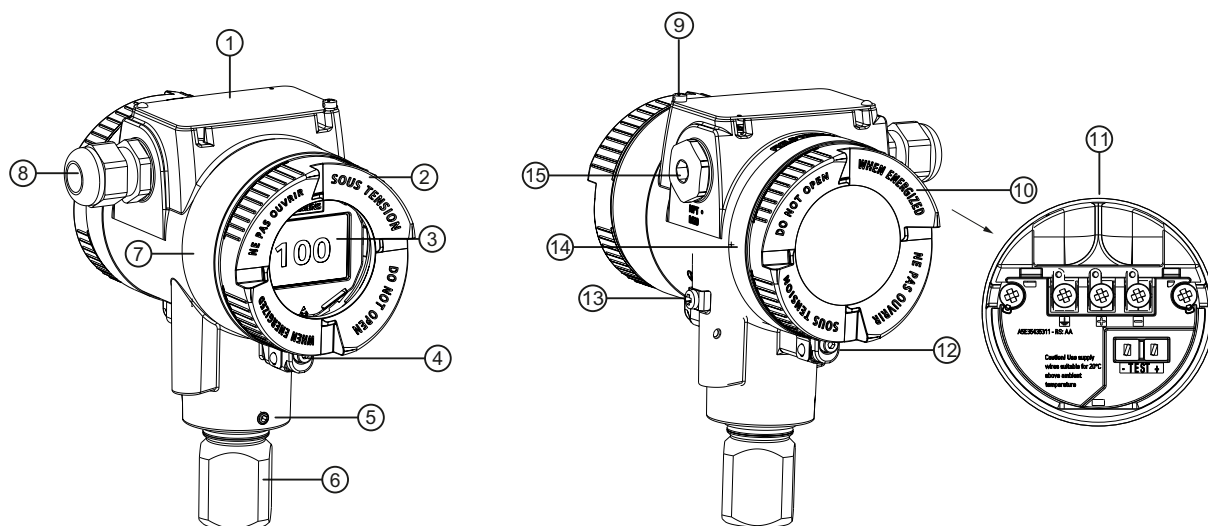

- | | |
|---|--|
| ① Cover over buttons and nameplate with general information | ⑨ Locking screw for the cover over the buttons |
| ② Cover with glass pane (optional) | ⑩ Cover (rear) for electrical terminal compartment |
| ③ Display (optional) | ⑪ Electrical terminal compartment |
| ④ Safety catch (front) | ⑫ Safety catch (back) |
| ⑤ Retaining screw for locking the enclosure (Page 60) | ⑬ Ground terminal |
| ⑥ Process connection | ⑭ Nameplate with information on the remote seal |
| ⑦ Nameplate with approval information | ⑮ Blanking plug |
| ⑧ Cable inlet, optionally with cable gland | |

Figure 4-1 Example

- The electronics enclosure is made of die cast aluminum or precision cast stainless steel.
- The housing has a removable cover at the front and the back.
- Depending on the device version, the front cover (②) may be designed with a glass pane.
- The cable gland (⑧) to the electrical terminal compartment is at the side; either the left or right-hand one can be used. The unused opening is closed with a blanking plug (⑮).
- The ground terminal (⑬) is located on the side.
- The electrical terminal compartment (⑪) for the supply voltage and shield is accessible when you remove the back cover (⑩).
- The measuring cell with a process connection (⑥) is located in the lower section of the enclosure.
The measuring cell is prevented from rotating by a retaining screw (⑤).
- The cover of the 4 buttons (①) is located on the upper face of the enclosure. The nameplate with general information is located on the cover.

4.3 Nameplate layout

Nameplate with general information

The nameplate with the article number and other important information, such as design details and technical data, is located on the cover over the buttons.

Example

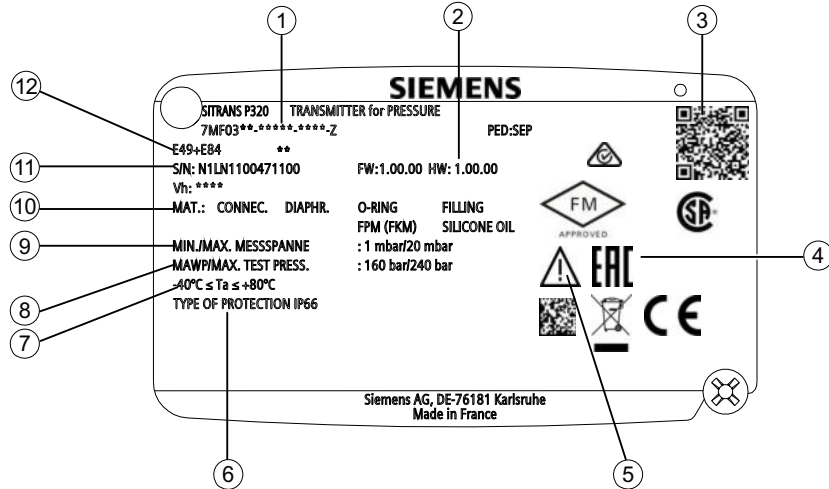

- ① Article number (MLFB number)
- ② Firmware and hardware identity
- ③ QR code to the mobile website with device-specific information
- ④ Conformity with country-specific directives
- ⑤ Note operating instructions, certificates and approvals
- ⑥ Protection class
- ⑦ Permitted ambient temperature for the hazardous area of the corresponding temperature class
- ⑧ Maximum permissible operating pressure / maximum permissible test pressure
- ⑨ Minimum/maximum measuring span
- ⑩ Material: Connection, diaphragm, O-ring, oil
- ⑪ Serial number
- ⑫ Order supplement (order code)

Nameplate with approval information

The nameplate with approval information is located on the front of the enclosure.

Examples

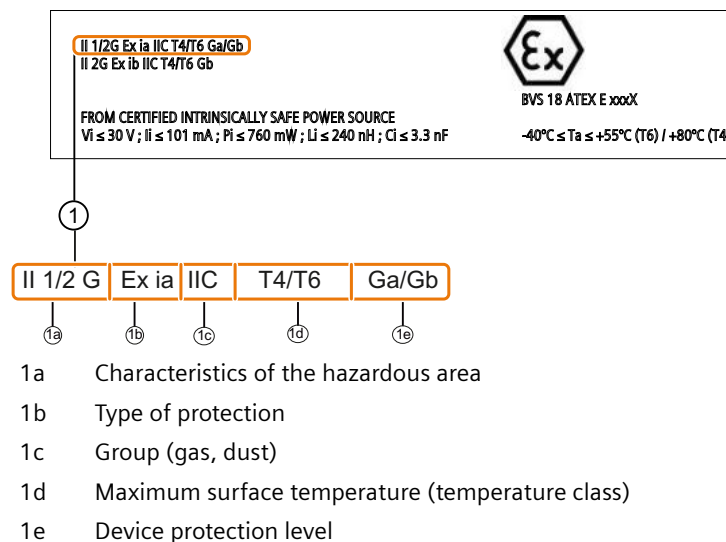

Figure 4-2 Example ATEX

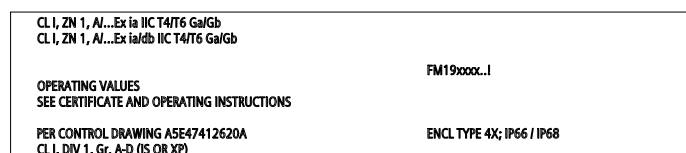
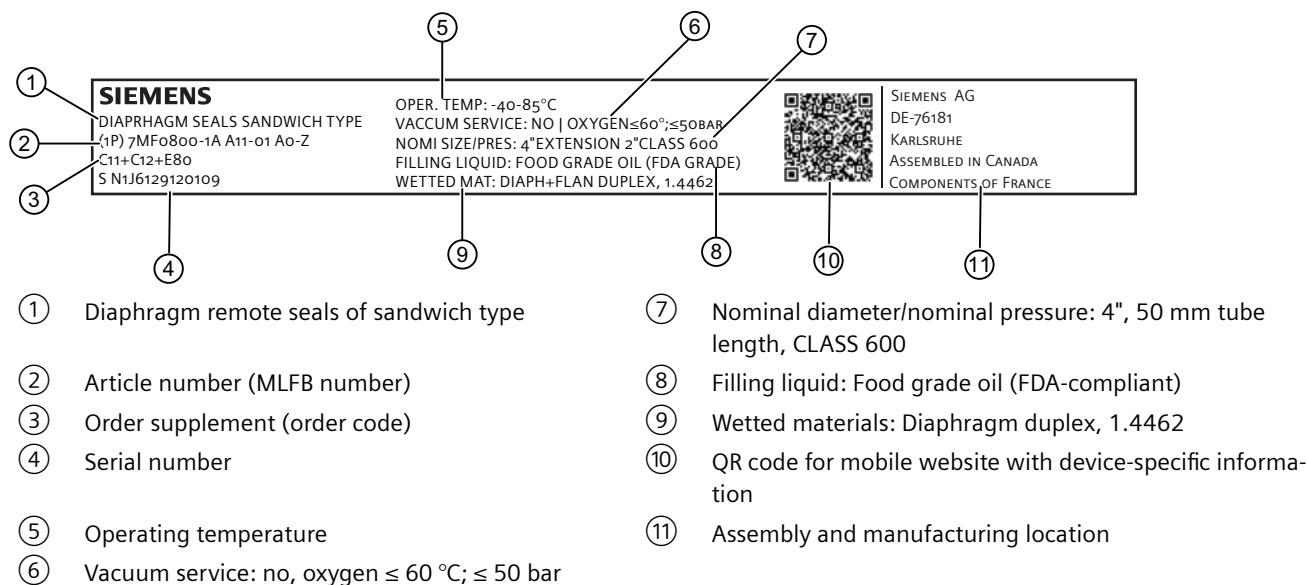

Figure 4-3 Example FM

Nameplate with information on the remote seals

The nameplate with information on the remote seals is located on the back of the enclosure.

Example



4.4 Tag plate

The tag plate is fastened with a wire under the front cover.

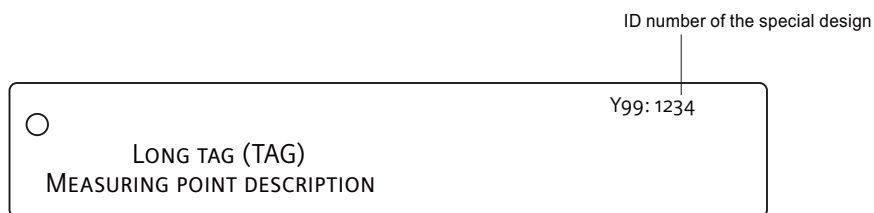

4.5 Functional principle

This chapter describes how the pressure transmitter works.

First the electronics are described, and then the physical principle of the sensors which are used with the various device versions for the individual measurement types.

4.5.1 Electronics

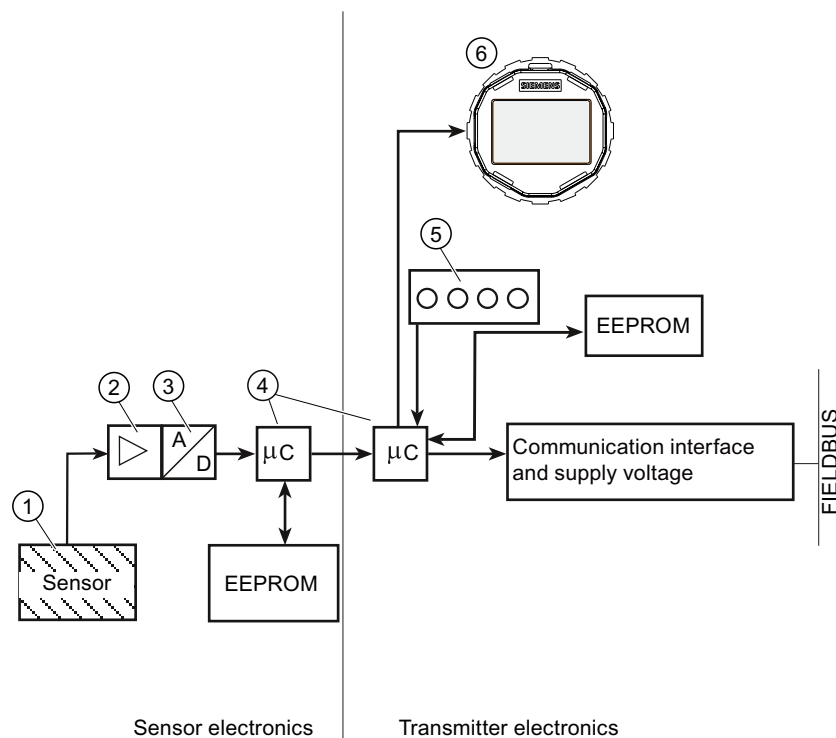

- ① Measuring cell sensor
- ② Measuring amplifier
- ③ Analog-to-digital converter
- ④ Microcontroller
- ⑤ Buttons
- ⑥ Display

- The inlet pressure is converted into an electrical signal by the sensor ①.
- This signal is amplified by the measuring amplifier ② and digitized in an analog-to-digital converter.
- The digital signal is analyzed in a microcontroller ④ and corrected with regard to linearity and thermal characteristics.
- Thereafter, the digital signal is made available via the communications interface (also referred to as "output signal" below).
- The measuring cell-specific data, electronics data and parameter assignment data are saved in two EEPROM modules. The first EEPROM module is linked to the measuring cell, the second EEPROM module to the electronics.

4.5.2 Measuring cell

4.5.2.1 Functional principle of the measuring cell

The following modes of operation are described:

- Gauge pressure
- Absolute pressure
- Differential pressure and flow
- Level

The following process connections are available, for example:

- G1/2 B, 1/2-14 NPT
- Male thread: M20
- Flange connection in accordance with EN 61518
- Flush-mounted process connections

In the following sections, the process variable to be measured is generally called inlet pressure.



WARNING

Destruction of the seal diaphragm

Danger of injury or damage to device

If the seal membrane is destroyed, the sensor may also be destroyed. If the seal membrane is destroyed, no reliable measured values can be output.

Hot, toxic and corrosive process media can be released.

- Ensure that the material of the device parts wetted by the process medium is suitable for the medium. Refer to the information in section Technical data (Page 163).
- Make sure that the device is suitable for the maximum operating pressure of your system. Refer to the information on the nameplate and/or in Technical data (Page 163).
- Define maintenance intervals for regular inspections in line with device use and empirical values. The maintenance intervals will vary from site to site depending on corrosion resistance.

4.5.2.2 Measuring cell for gauge pressure

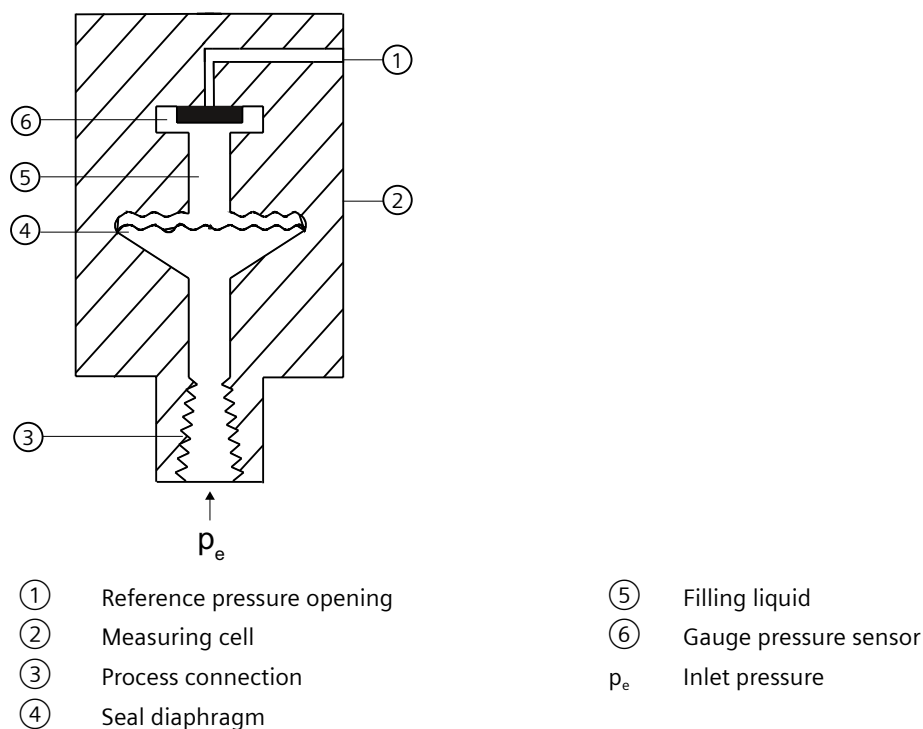

Figure 4-4 Function chart of measuring cell for gauge pressure

The inlet pressure (p_e) is transferred to the gauge pressure sensor ⑥ via the seal diaphragm ④ and the fill fluid ⑤, displacing its measuring diaphragm. The displacement changes the resistance of the four piezoresistors (bridge circuit) of the gauge pressure sensor. The change in the resistance causes a bridge output voltage proportional to the inlet pressure.

Pressure transmitters with measuring span ≤ 63 bar measure the inlet pressure against atmosphere, those with measuring spans ≥ 160 bar the inlet pressure against vacuum.

4.5.2.3 Measuring cell for gauge pressure, front-flush membrane

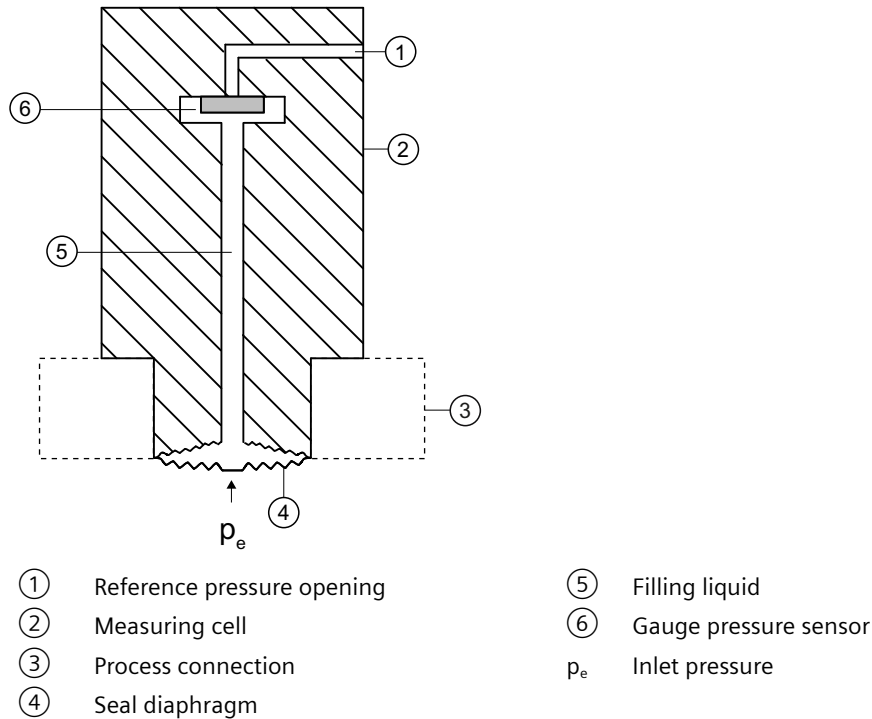
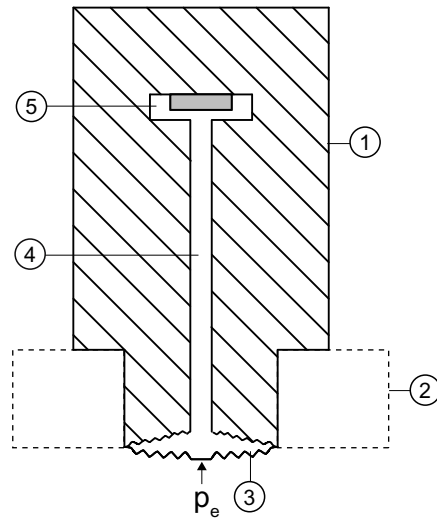

Figure 4-5 Function chart of the measuring cell for gauge pressure, flush mounted diaphragm

The inlet pressure (p_e) is transferred to the gauge pressure sensor ⑥ via the seal diaphragm ④ and the filling liquid ⑤, displacing its measuring diaphragm. The displacement changes the resistance of the four piezoresistors (bridge circuit) of the gauge pressure sensor. The change in the resistance causes a bridge output voltage proportional to the inlet pressure.

Pressure transmitters with measuring span ≤ 63 bar measure the inlet pressure against atmosphere, those with measuring spans ≥ 160 bar the inlet pressure against vacuum.

4.5.2.4 Measuring cell for absolute pressure from the gauge pressure series



- | | | | |
|---|--------------------|-------|--------------------------|
| ① | Measuring cell | ④ | Filling liquid |
| ② | Process connection | ⑤ | Absolute pressure sensor |
| ③ | Seal diaphragm | P_e | Inlet pressure |

Figure 4-6 Function chart of measuring cell for absolute pressure

- The inlet pressure (p_e) is transferred to the absolute pressure sensor (⑤) via the seal diaphragm (③) and the fill fluid (④), displacing its measuring diaphragm.
- The displacement changes the resistance of the four piezoresistors (bridge circuit) of the absolute pressure sensor.
- The change in the resistance causes a bridge output voltage proportional to the inlet pressure.

4.5.2.5 Measuring cell for absolute pressure, front-flush membrane

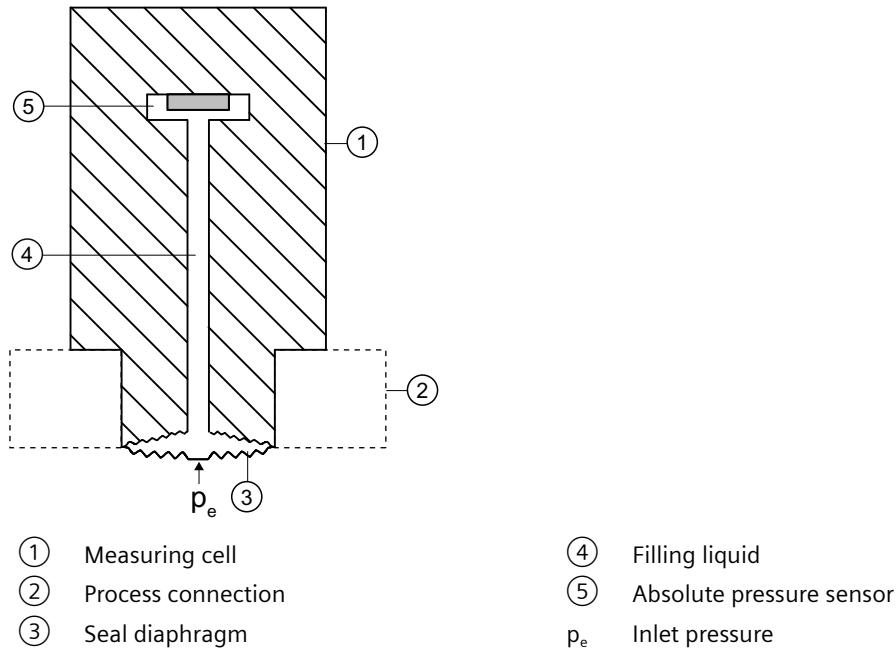
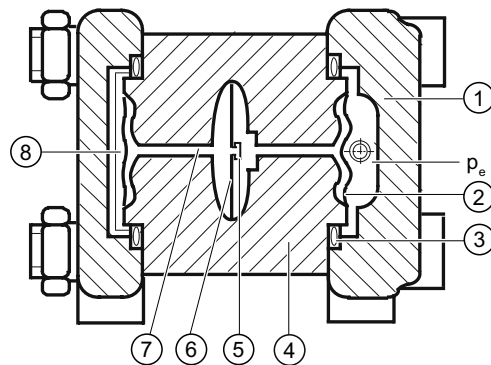

Figure 4-7 Function chart of the measuring cell for absolute pressure, flush mounted diaphragm

- The inlet pressure (p_e) is transferred to the absolute pressure sensor ⑤ via the seal diaphragm ③ and the filling liquid ④, and displaces its measuring diaphragm.
- The displacement changes the resistance of the four piezoresistors (bridge circuit) of the absolute pressure sensor.
- The change in the resistance causes a bridge output voltage proportional to the inlet pressure.

4.5.2.6 Measuring cell for absolute pressure from the differential pressure series



- | | | | |
|---|--------------------------------------|-------|-------------------------------|
| ① | Pressure cap | ⑥ | Overload diaphragm |
| ② | Seal diaphragm on the measuring cell | ⑦ | Measuring cell filling liquid |
| ③ | O-ring | ⑧ | Reference pressure |
| ④ | Measuring cell body | p_e | Pressure input variable |
| ⑤ | Absolute pressure sensor | | |

Figure 4-8 Function chart of measuring cell for absolute pressure

- Absolute pressure is transmitted to the absolute pressure sensor ⑤ through the seal diaphragm ② and the filling liquid ⑦.
- When measuring limits are exceeded, the overload diaphragm ⑥ is displaced until the seal diaphragm ② rests on the measuring cell body ④. The seal diaphragm thus protects the absolute pressure sensor ⑤ from overload.
- The difference between the inlet pressure (p_e) and the reference pressure ⑧ on the negative side of the measuring cell displaces the seal diaphragm ②. The displacement changes the resistance of the four piezoresistors (bridge circuit) of the absolute pressure sensor.
- The change in the resistance causes a bridge output voltage proportional to the absolute pressure.

4.5.2.7 Measuring cell for differential pressure and flow rate

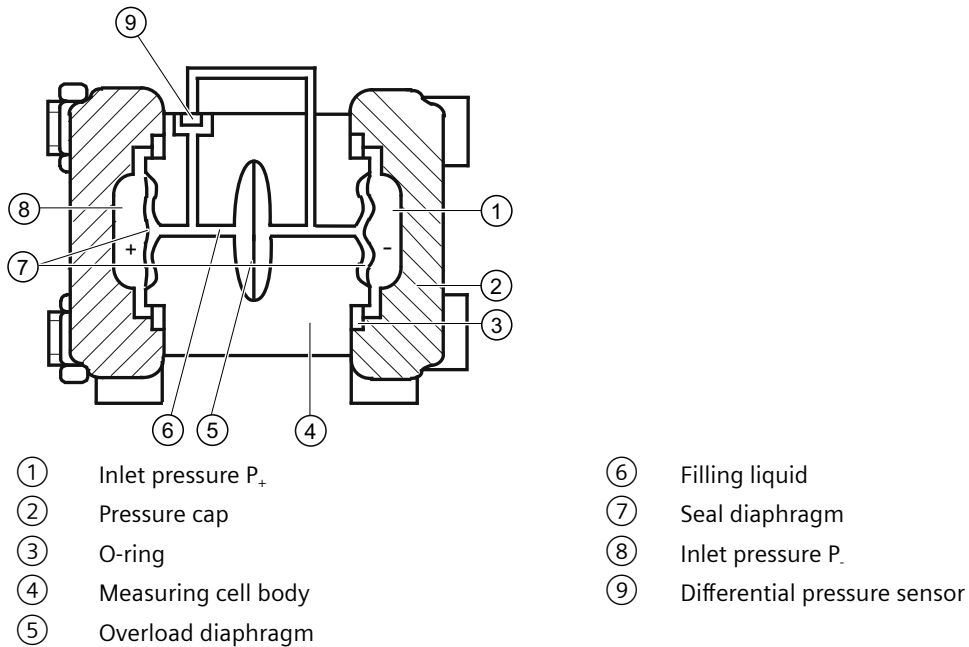
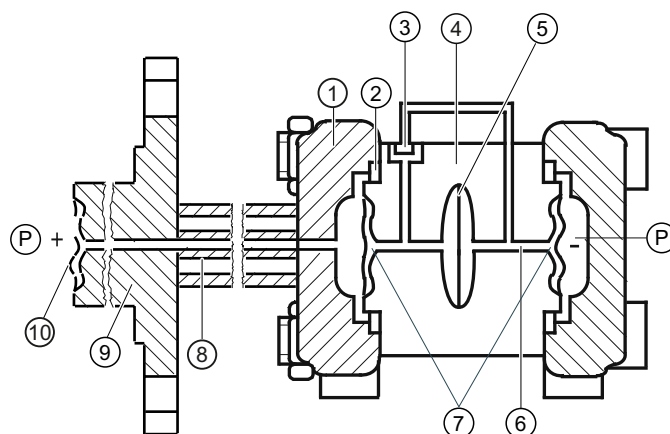

Figure 4-9 Function chart of the measuring cell for differential pressure and flow rate

- Differential pressure is transmitted to the differential pressure sensor (9) through the seal diaphragms (7) and the filling liquid (6).
- When measuring limits are exceeded, the seal diaphragm (7) is displaced until the seal diaphragm rests on the measuring cell body (4). The differential pressure sensor (9) is thus protected against overloading since no further deflection of the overload diaphragm (5) is possible.
- The seal diaphragm (7) is displaced by the differential pressure. The displacement changes the resistance of the four piezoresistors (bridge circuit) of the differential pressure sensor.
- The change in the resistance causes a bridge output voltage proportional to the differential pressure.

4.5.2.8 Measuring cell for level



P	Input pressure P_+ and P_- .	⑥	Filling liquid of the measuring cell
①	Seal diaphragm on the measuring cell	⑦	Seal diaphragm on the measuring cell
②	O-ring	⑧	Capillary tube with the filling liquid of the mounting flange
③	Differential pressure sensor	⑨	Flange with a tube
④	Measuring cell body	⑩	Seal diaphragm on the mounting flange
⑤	Overload diaphragm		

Figure 4-10 Function chart of the measuring cell for level

- The input pressure (hydrostatic pressure) works hydraulically on the measuring cell through the seal diaphragm ⑨ on the mounting flange.
- The differential pressure at the measuring cell is transmitted to the differential pressure sensor ③ through the seal diaphragms ① and the filling liquid ⑥.
- When measuring limits are exceeded, the overload diaphragm ⑤ is displaced until one of the seal diaphragms ⑦ or ⑩ rests on the measuring cell body ④. The seal diaphragms ⑦ thus protect the differential pressure sensor ③ from overload.
- The seal diaphragm ⑦ is displaced by the differential pressure. The displacement changes the resistance of the four doped piezoresistors in the bridge circuit.
- The change in the resistance causes a bridge output voltage proportional to the differential pressure.

4.6 System configuration

The device can be used in a number of system configurations.

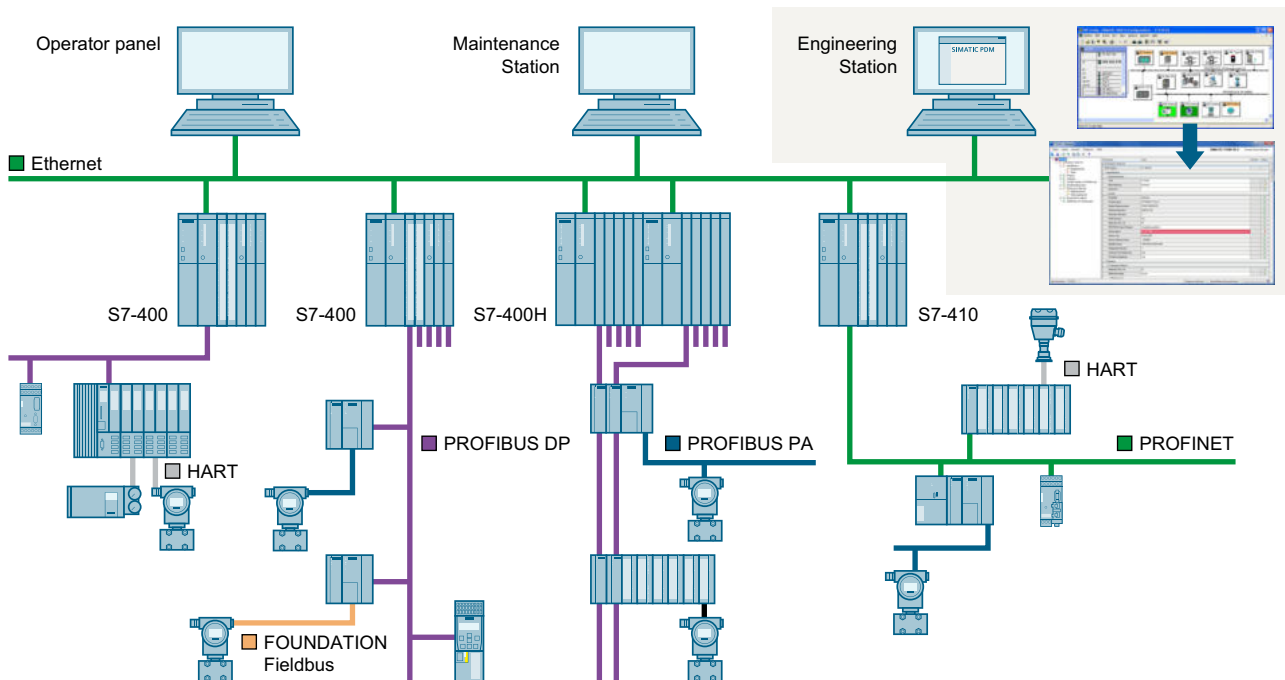

Figure 4-11 Example: SIMATIC S7

Communication via PROFIBUS PA and FOUNDATION Fieldbus

You can configure and operate the device via PROFIBUS PA and FOUNDATION Fieldbus. For this, you need:

- PA Link or FF Link to the gateway between PROFIBUS PA or FOUNDATION Fieldbus to the PROFIBUS DP
- Control system, e.g. SIMATIC PCS 7 Automation System, which communicates over PROFIBUS
- Engineering station, SIMATIC PDM (Process Device Manager) which communicates over Industrial Ethernet

Installing/mounting

5.1 Basic safety instructions

 DANGER
<p>Pressure applications</p> <p>Danger to personnel, system and environment will result from improper disassembly.</p> <ul style="list-style-type: none"> • Never attempt to loosen, remove, or disassemble process connection while vessel contents are under pressure.

 WARNING
<p>Wetted parts unsuitable for the process media</p> <p>Risk of injury or damage to device.</p> <p>Hot, toxic and corrosive media could be released if the wetted parts are unsuitable for the process medium.</p> <ul style="list-style-type: none"> • Ensure that the material of the device parts wetted by the process medium is suitable for the medium. Refer to the information in Technical data (Page 163).

 WARNING
<p>Unsuitable connecting parts</p> <p>Risk of injury or poisoning.</p> <p>In case of improper mounting, hot, toxic, and corrosive process media could be released at the connections.</p> <ul style="list-style-type: none"> • Ensure that connecting parts (such as flange gaskets and bolts) are suitable for connection and process media.

 WARNING
<p>Exceeded maximum permissible operating pressure</p> <p>Risk of injury or poisoning.</p> <p>The maximum permissible operating pressure depends on the device version, pressure limit and temperature rating. The device can be damaged if the operating pressure is exceeded. Hot, toxic and corrosive process media could be released.</p> <p>Ensure that maximum permissible operating pressure of the device is not exceeded. Refer to the information on the nameplate and/or in Technical data (Page 163).</p>

⚠ WARNING

Incorrect material for the diaphragm in Zone 0

Risk of explosion in the hazardous area. If operated with intrinsically safe supply devices of category "ib" or devices of the flameproof enclosure version "Ex d" and simultaneous use in Zone 0, pressure transmitter explosion protection depends on the tightness of the diaphragm.

- Ensure that the material used for the diaphragm is suitable for the process medium. Refer to the information in the section "Technical data (Page 163)".

⚠ WARNING

Loss of safety for devices with "flameproof enclosure" type of protection

Risk of explosion in hazardous areas. An explosion may be caused by hot gas escaping from the flameproof enclosure if there is too little space between it and fixed parts (e.g. walls, pipes).

- Ensure that there is a minimum clearance of at least 40 mm between the flameproof joints and the fixed parts.

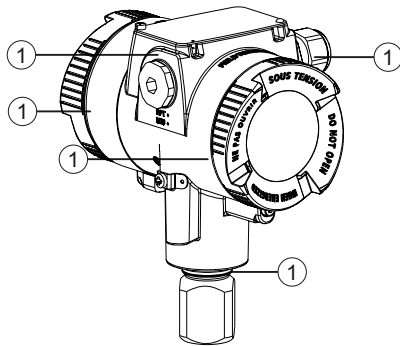

① Flameproof joint

⚠ WARNING

Using safety extra-low voltage for devices of the protection type "db", "ec", "tb" or "tc"

Risk of explosion in hazardous areas.

- Disconnect the non-intrinsically safe circuit safely from ground, e.g. using an SELV circuit.

 **WARNING**

Vibrations in the plant

Risk of injury or damage to device.

Vibration leads to material fatigue, for example, cracks and weld seams breaks.

Hot, toxic and corrosive process media can emerge.

- Make sure that you have mounted the pressure transmitter (including accessories) protected against vibration. Refer to the information on vibration resistance in the section Technical specifications (Page 163).

 **CAUTION**

Hot surfaces resulting from hot process media

Risk of burns resulting from surface temperatures above 65 °C (149 °F).

- Take appropriate protective measures, for example contact protection.
- Make sure that protective measures do not cause the maximum permissible ambient temperature to be exceeded. Refer to the information in Technical data (Page 163).

 **CAUTION**

External stresses and loads

Damage to device by severe external stresses and loads (e.g. thermal expansion or pipe tension). Process media can be released.

- Prevent severe external stresses and loads from acting on the device.

Note

Material compatibility

Siemens can provide you with support concerning selection of sensor components wetted by process media. However, you are responsible for the selection of components. Siemens accepts no liability for faults or failures resulting from incompatible materials.

5.1.1 Installation location requirements

⚠ WARNING
Insufficient air supply
The device may overheat if there is an insufficient supply of air.
<ul style="list-style-type: none">• Install the device so that there is sufficient air supply in the room.• Observe the maximum permissible ambient temperature. Refer to the information in the section Technical data (Page 163).

NOTICE
Aggressive atmospheres
Damage to device through penetration of aggressive vapors.
<ul style="list-style-type: none">• Ensure that the device is suitable for the application.

NOTICE
Direct sunlight
Increased measuring errors.
<ul style="list-style-type: none">• Protect the device from direct sunlight.
Make sure that the maximum ambient temperature is not exceeded. Refer to the information in the section Technical data (Page 163).

5.1.1.1 Devices with marine approval

Note

For vibrations in the direction of the measuring cell diaphragm, the measuring accuracy of the pressure transmitter with flush-mounted diaphragm can deviate no more than 0.2% from the respective specification.

- Install the device so that no or almost no vibrations occur in the direction of the diaphragms.
- To avoid measuring values that fluctuate strongly, use the damping function.

For information on vibration resistance, refer to the marine approval certificate.

5.1.2 Proper mounting

 WARNING
Incorrect mounting at Zone 0 Risk of explosion in hazardous areas. <ul style="list-style-type: none">• Ensure sufficient tightness at the process connection.• Observe the standard IEC/EN 60079-14.

NOTICE
Incorrect mounting The device can be damaged, destroyed, or its functionality impaired through improper mounting. <ul style="list-style-type: none">• Before installing ensure there is no visible damage to the device.• Make sure that process connectors are clean, and suitable gaskets and glands are used.• Mount the device using suitable tools. Refer to the information in Technical data (Page 163).

NOTICE
Use of line and cable entries made of plastic in hazardous areas Device damage caused by impact at temperatures below -20 °C. <ul style="list-style-type: none">• Make sure that the line and cable entries are protected from impacts.

5.2 Installation (except level)

Before you mount the device

- Compare the operating data with the data on the nameplate of the pressure transmitter.
- Observe the minimum and maximum permissible ambient and medium temperature limits also under the influence of convection and heat radiation.
- Note the effect of the ambient temperature on the measuring accuracy in the section Technical data (Page 163).
- For remote seal mounting, observe the notes in the section "Mounting with remote seal" of the operating instructions.

Mounting location

Verify that the mounting location meets the following conditions:

- Accessible
- Close to the measuring point

5.2 Installation (except level)

- Vibration-free
- Within the permitted ambient temperature values

Protect the pressure transmitter from:

- Direct heat radiation
- Sudden temperature fluctuations
- Heavy contamination
- Mechanical damage
- Direct sunlight

Procedure

1. Select the arrangement of the pressure transmitter depending on the aggregate state of the medium.

Gas	Vapor or liquid
Above the pressure sampling point	Below the pressure sampling point
Lay the pressure line with a constant gradient to the pressure sampling point, so that any condensation produced can drain in the main line and thereby avoid corruption of the measured values.	Lay the pressure line with a constant gradient to the pressure sampling point so that any gas pockets can escape in the main line.

2. Attach the pressure transmitter to the process connection.
Use an appropriate tool (e.g. open-ended wrench with width across flats 36). Otherwise, the measuring cell may be damaged.
3. Turn only on the key area above the process connection.
Caution: If you turn the pressure transmitter on the housing, the measuring cell may be damaged.

- For insulated systems, ensure that you insulate the device as far as possible to the lower edge of the enclosure.
In this way, you avoid a defect in the device or the loss of explosion protection for Ex devices. You can find the permissible temperature values in the section Technical data (Page 163).

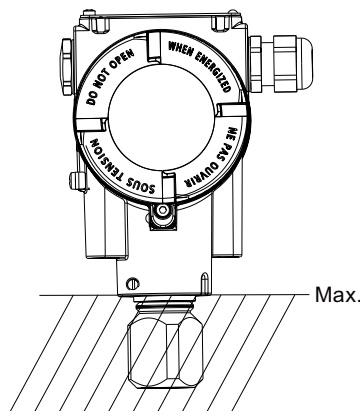

- To guarantee secure and vibration-free installation of the pressure transmitter, fasten it to a mounting bracket (Page 45).

Level

You can find details on how to mount the device with level in the section Installation (level) (Page 47).

5.3 Securing the device with mounting bracket

Here you have the following mounting options with the mounting bracket:

- On a mounting range
- On a vertical or horizontal pipe (\varnothing 50 to 60 mm), according to the examples 1 and 2

Safety notes

NOTICE

Mounting with differential pressure lines

Differential pressure lines can break if they are not mounted correctly.

- Install the device so that the pressure transmitter and the differential pressure lines are not subject to different vibrations.

NOTICE

Use of mounting bracket in maritime applications

Device damages in case of vibration

- Secure the mounting bracket as shown in the figures.

Note

When securing the mounting bracket, observe the torques in the section Torques (Page 203).

Example 1: Pipe mounting of pressure transmitter (gauge pressure series)

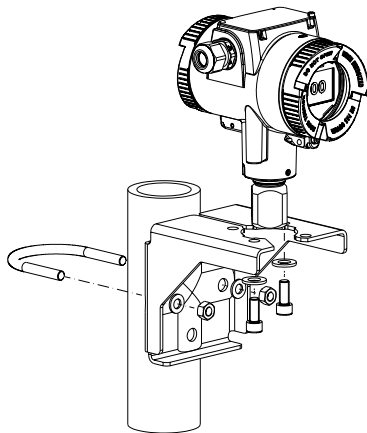

Example 2: Pipe mounting of pressure transmitter (differential pressure series)

The following positions are possible:

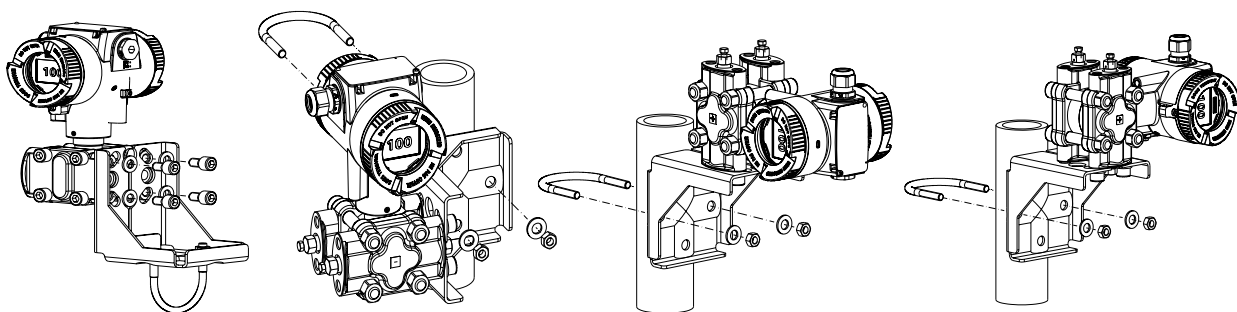

5.4 Mounting hygienic version

To avoid formation of steam, mount the pressure transmitter as follows, for example:

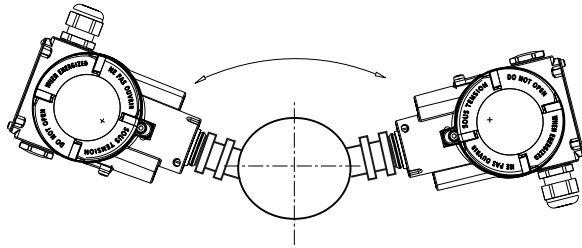

Figure 5-1 Correct installation

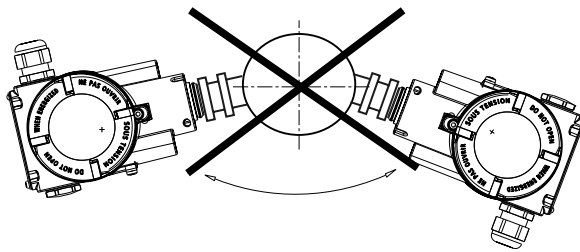

Figure 5-2 Incorrect installation

- Ensure that the length of the dead space at the end of the process connection is smaller than its diameter.
- To ensure optimal cleaning of the process plant, install the process connection without offset (flush-mounted on inside) in the plant.
You can find additional information in the EHEDG Guidelines No. 10 and No. 37.

5.5 Installation (level)

Before you mount the device

- Compare the operating data with the data on the nameplate of the pressure transmitter.
- Observe the minimum and maximum permissible ambient and medium temperature limits also under the influence of convection and heat radiation.
- Note the effect of the ambient temperature on the measuring accuracy in the section Technical data (Page 163).
- For remote seal mounting, observe the notes in the section "Mounting with remote seal" of the operating instructions.

Mounting location

Verify that the mounting location meets the following conditions:

- Accessible
- Close to the measuring point

5.5 Installation (level)

- Vibration-free
- Within the permitted ambient temperature values

Protect the pressure transmitter from:

- Direct heat radiation
- Rapid temperature fluctuations
- Heavy contamination
- Mechanical damage
- Direct sunlight

Note

Select the height of the mounting flange such that the pressure transmitter is always mounted below the lowest fill height to be measured.

Procedure

1. Attach the seal to the container's mating flange.
Ensure that the seal is centrally positioned and that it does not restrict the movement of the flange's seal diaphragm in any way. Otherwise, the seal of the process connection is not guaranteed to be tight.
2. Screw on the pressure transmitter's flange.
3. Observe the installation position.

5.5.1 Mounting on the container

Mounting on open container

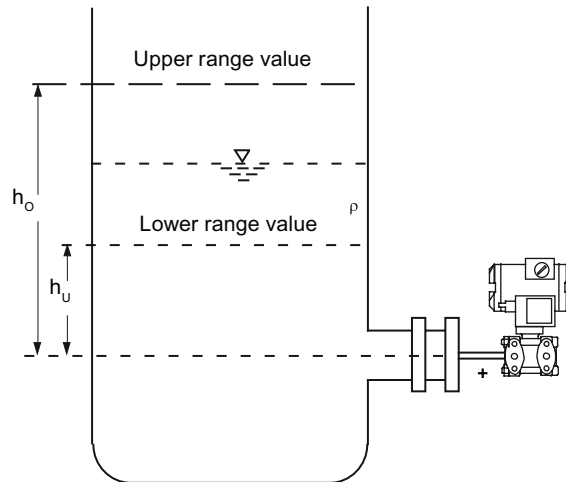

Formula

$$p_{MA} = \rho \cdot g \cdot h_U$$

$$p_{ME} = \rho \cdot g \cdot h_O$$

h_U Lower filling level

h_O Upper filling level

p Pressure

p_{LRV} Lower range value

p_{URV} Upper range value

ρ Density of the measured medium in the container

g Acceleration due to gravity

A line is not required when taking measurements in an open container because the low pressure side is connected to the atmosphere.

Ensure that no dirt enters the open connection ports. To this end, use a threaded plug with vent valve 7MF4997-1CP, for example.

Mounting on the closed container (no or little condensate formation)

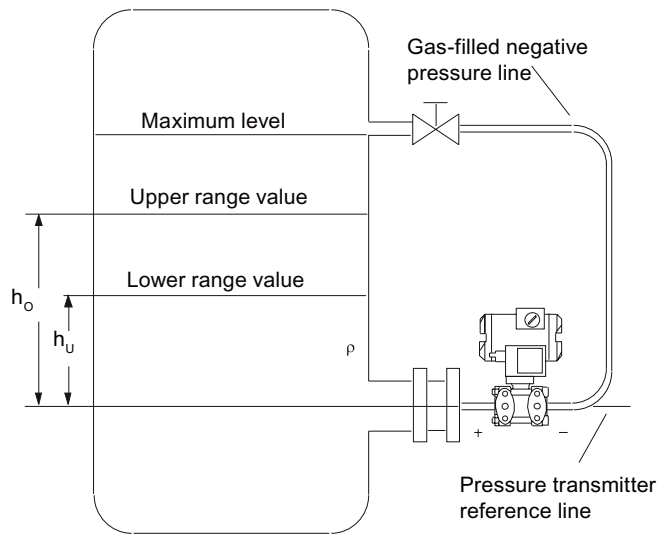

Formula

$$p_{MA} = \rho \cdot g \cdot h_U$$

$$p_{ME} = \rho \cdot g \cdot h_O$$

h_U Lower filling level

h_O Upper filling level

ρ Pressure

p_{LRV} Lower range value

p_{URV} Upper range value

ρ Density of the measured medium in the container

g Acceleration due to gravity

When taking measurements in a closed container without or with little condensate formation, the low pressure line is not filled.

Lay the line in such a way that condensation pockets do not form. If required, you need to install a condensation container below the low pressure line of the pressure transmitter.

The process connection on the low pressure side is a female thread $1/4$ -18 NPT or an oval flange.

Lay the line for the low pressure using a seamless steel tube 12 mm x 1.5 mm.

Mounting on closed container (heavy condensate formation)

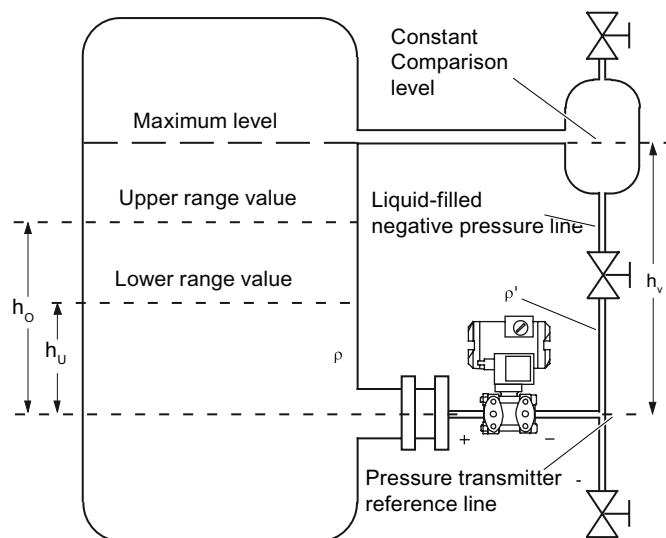

Formula

$$P_{MA} = g \cdot (h_U \cdot \rho - h_V \cdot \rho')$$

$$P_{MA} = g \cdot (h_O \cdot \rho - h_V \cdot \rho')$$

h_U Lower filling level

h_O Upper filling level

h_V Gland distance

p Pressure

p_{LRV} Lower range value

p_{URV} Upper range value

ρ Density of the measured medium in the container

ρ' Density of fluid in the low pressure line corresponds to the prevailing temperature there

g Acceleration due to gravity

When taking measurements in a closed container with strong condensate formation, you must fill the low pressure line (mostly with the condensate of the measured medium) and install a condensate pot.

Lock the device using the 2-way valve manifold 7MF9017-..A.

To compensate the liquid column on the low pressure side, reset the zero point.

5.6 Installation with remote seal

General information

- Keep the measuring system in the factory packing until it is installed in order to protect it from mechanical damage.
- When removing from the factory packing and installing: ensure that damage to and mechanical deformations in the membrane are prevented.
- Never loosen the sealed filling screws on the remote seal and the measuring instrument.

5.6 Installation with remote seal

- Do not cause damage to the remote separating membrane; scratches on the remote separating membrane, e.g. due to sharp-edged objects, are the main starting points for corrosion.
 - Select suitable gaskets for sealing.
 - Use a gasket having an adequately large inner diameter for flanging. Insert the gasket concentrically; contact with the membrane leads to deviations in measurements.
 - When using gaskets made of soft materials or PTFE: follow the guidelines of the gasket manufacturer, especially regarding the tightening torque and setting cycles.
 - At the time of installation, use suitable fastening components such as screws and nuts that are compliant with fitting and flange standards.
 - Excessive tightening of screwed joints on the process connection may displace the zero point on the pressure transmitter.
-

Note

Commissioning

When a shut-off valve exists, open the shut-off valve slowly when commissioning to avoid pressure surges.

Note

Permissible ambient and operating temperatures

- Observe the minimum and maximum permissible ambient and medium temperature limits also under the influence of convection and heat radiation.
 - Note the effect of the ambient temperature on the measuring accuracy in the section Technical data (Page 163).
 - The material and the pressure rating of the fittings and flange components must be suitable for the pressure and the temperature of your plant (or measuring arrangement).
 - The pressure rating specified on the remote seal is specified to reference conditions according to IEC 62828.
-

Using remote seals with pressure measuring device for hazardous areas:

- When using remote seals with pressure transmitters in hazardous areas, the permissible ambient temperature limits for the pressure transmitter must not be exceeded. Hot surfaces on the cooling section (capillaries or cooling elements) are a possible source of ignition. Initiate suitable measures.
- When remote seals with a flame arrestor are used, the pressure measuring instrument determines the permissible ambient temperature. In the case of potentially explosive gaseous atmosphere, the temperature around the flame arrestor must not exceed +60 °C.

5.6.1 Remote seal with capillary line

General information

- Do not transport the measuring assembly (pressure transmitter, flange and capillary line) by holding the capillary line.
- Do not bend the capillary lines. Otherwise there may be a leakage risk and the set-up time of the measuring system is increased.
- A mechanical overload at the connection points between capillary line and remote seal or between capillary line and pressure transmitter will lead to potential bending or breaking.
- Wind capillary lines that are too long with a radius of at least 300 mm.
- Fasten the capillary line such that there are no vibrations.

Installation type for gauge pressure and level measurements (open containers)

Installation type A: Pressure transmitter above the measuring point

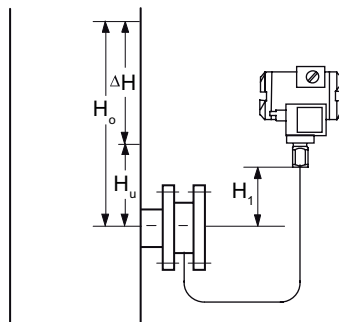

Formula

$$p_{MA} = \rho_{FL} * g * H_U - \rho_{oil} * g * H_1$$

$$p_{URV} = \rho_{FL} * g * H_O - \rho_{oil} * g * H_1$$

p_{LRV} Lower range value

p_{URV} Upper range value

ρ_{FL} Density of the medium in the container

ρ_{oil} Density of the filling oil in the capillary line of the remote seal

g Acceleration due to gravity

H_U Lower filling level

H_O Upper filling level

H_1 Distance container flange to pressure transmitter

- In the case of remote seal measuring systems with silicone, glycerin or paraffin oil filling, the height difference (H_{1max}) is ≤ 7 m.
- If halocarbon oil is used as the filling liquid, this maximum height difference is only ≤ 4 m.
- If a negative overpressure is observed during measurements, reduce the permissible height difference.

Installation type B: Pressure transmitter below the measuring point

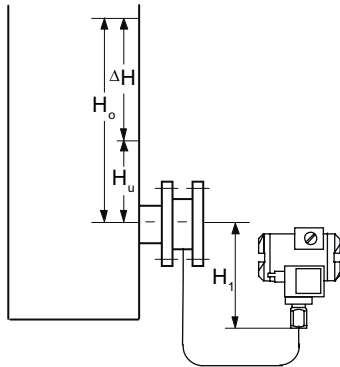

Formula

$$p_{MA} = \rho_{FL} * g * H_U + \rho_{oil} * g * H_1$$

$$p_{ME} = \rho_{FL} * g * H_O + \rho_{oil} * g * H_1$$

p_{LRV} Start of scale value

p_{URV} Full-scale value

ρ_{FL} Density of the process medium in the container

ρ_{oil} Density of the filling oil in the capillary line of the remote seal

g Acceleration due to gravity

H_U Lower filling level

H_O Upper filling level

H_1 Distance container flange to pressure transmitter

- In the case of remote seal measuring systems with silicone, glycerin or paraffin oil filling, the height difference (H_{1max}) is ≤ 7 m.
- If halocarbon oil is used as the filling liquid, this maximum height difference is only ≤ 4 m.

Installation types for absolute pressure measurements (closed containers)

For absolute pressure measurements (vacuum), install the pressure transmitter at least at the height of the remote seal or below the measuring point:

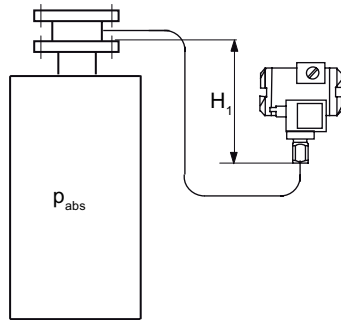
Mounting type C: at the height of the remote seal**Formula**

$$p_{MA} = p_{initial} + \rho_{oil} * g * H_1$$

$$p_{ME} = p_{final} + \rho_{oil} * g * H_1$$

p_{LRV} Lower range value

p_{URV} Upper range value

p_{start} Initial pressure in the container

p_{end} Final pressure in the container

ρ_{oil} Density of the filling oil in the capillary line of the remote seal

g Acceleration due to gravity

H_1 Distance container flange to pressure transmitter

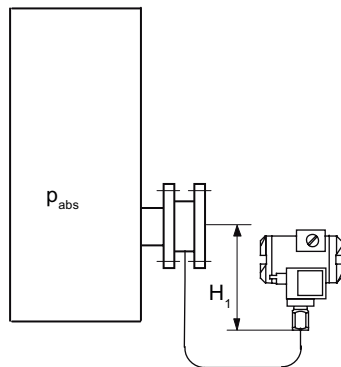
Mounting type D: below the measurement point**Formula**

$$p_{MA} = p_{initial} + \rho_{oil} * g * H_1$$

$$p_{ME} = p_{final} + \rho_{oil} * g * H_1$$

p_{LRV} Start of scale value

p_{URV} Full-scale value

p_{start} Initial pressure in the container

p_{end} Final pressure in the container

ρ_{oil} Density of the filling oil in the capillary line of the remote seal

g Acceleration due to gravity

H_1 Distance container flange to pressure transmitter

$H_1 \geq 200 \text{ mm}$

Mounting type for differential pressure and flow measurements

Note

Effects of temperature

Keep the following instructions in mind to minimize the effects of temperature in remote seal measuring systems with differential pressure transmitter:

- Install the device so that the high pressure and low pressure sides are symmetrical as far as ambient effects and the ambient temperature are concerned.

Mounting type E

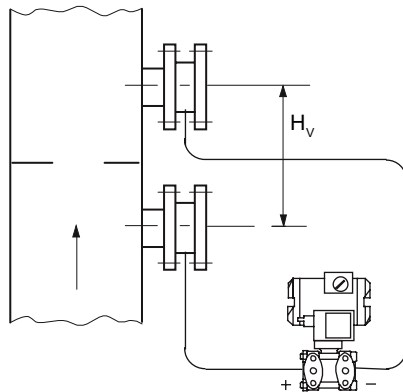

Formel

$$p_{MA} = p_{initial} - \rho_{oil} * g * H_v$$

$$p_{ME} = p_{final} - \rho_{oil} * g * H_v$$

p_{LRV} Start of scale value

p_{URV} Full-scale value

p_{start} Initial pressure in the container

p_{end} Final pressure in the container

ρ_{oil} Density of the filling oil in the capillary line of the remote seal

g Acceleration due to gravity

H_v Gland distance

H_1 Distance container flange to pressure transmitter

Installation types for level measurements (closed containers)

Reset the zero point after installation to compensate the liquid column on the minus side.

This measure applies to the following installation types:

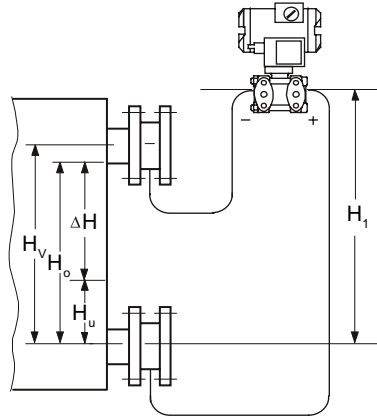

Mounting type F

$H_1 \leq 7 \text{ m (23 ft)}$; with halocarbon oil as the filling liquid, only $H_1 \leq 4 \text{ m (13.1 ft)}$

Start of scale value:

$$p_{LRV} = \rho_{FL} * g * H_u - \rho_{oil} * g * H_v$$

Full-scale value:

$$p_{URV} = \rho_{FL} * g * H_o - \rho_{oil} * g * H_v$$

Pressure transmitter for differential pressure above the upper measuring point, no vacuum

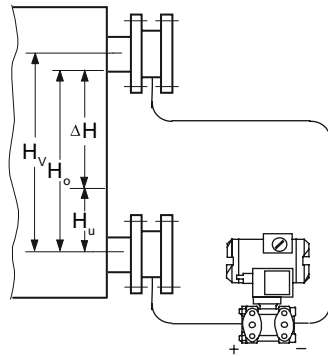

Mounting type G

Start of scale value:

$$p_{LRV} = \rho_{FL} * g * H_u - \rho_{oil} * g * H_v$$

Full-scale value:

$$p_{URV} = \rho_{FL} * g * H_o - \rho_{oil} * g * H_v$$

Below the lower measuring point

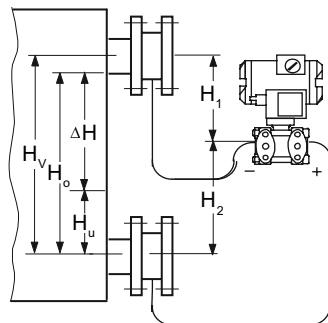

Mounting type H

$H_2 \leq 7 \text{ m (23 ft)}$; with halocarbon oil as the filling liquid, only $H_2 \leq 4 \text{ m (13.1 ft)}$

Start of scale value:

$$p_{LRV} = \rho_{FL} * g * H_u - \rho_{oil} * g * H_v$$

Full-scale value:

$$p_{URV} = \rho_{FL} * g * H_o - \rho_{oil} * g * H_v$$

Between the measuring points, no vacuum

Key

p_{LRV}	Start of scale value
p_{URV}	Full-scale value
ρ_{FL}	Density of the process medium in the container
ρ_{oil}	Density of the filling oil in the capillary line of the remote seal
g	Acceleration due to gravity
H_U	Lower filling level
H_O	Upper filling level
H_V	Gland distance
H_1/H_2	Distance container flange to pressure transmitter

5.7 Installing electrical connections and cable entries

The device is delivered with dust caps installed on both sides at the factory.

You use the order options starting with A to define the type of electrical connections and cable entries (cable gland, sealing plug or device plug) for your device.

These components are delivered with the device.

- To order the device with installed electrical connections and cable entries, select an additional order option for the installation (e.g. "device plug mounted on the right").

Procedure

For the first installation follow these steps:

1. Ensure that the seals are clean and undamaged.
2. To ensure the IP degree of protection and explosion protection of the pressure transmitter, close the cable entries with a sealing plug, a cable gland or a device plug.

A description of how to replace electrical connections and cable entries is available in section Replacing electrical connections and cable entries (Page 147).

5.8 Rotating the display

To read the display in any mounting position, you have the option of gradually rotating the display 360°.

Procedure

1. De-energize the device.
2. If available, loosen the front safety catch with a 3 mm Allen key.
3. Unscrew the front cover.

4. Remove the display from the holder.

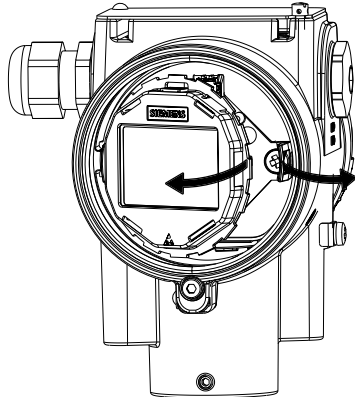

5. Leave the display cable plugged into the electronics.
6. Rotate the display to the desired position.

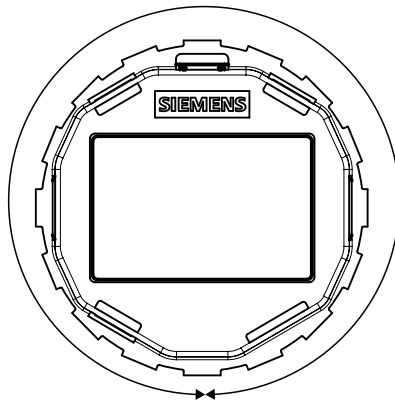

7. Press the display into the holder until it engages.

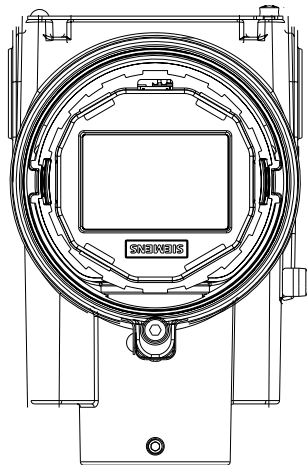

5.9 Rotating the enclosure

Introduction

To make the device easier to operate in any mounting position, you have the option of adjusting the position of the enclosure within a range of 360°.

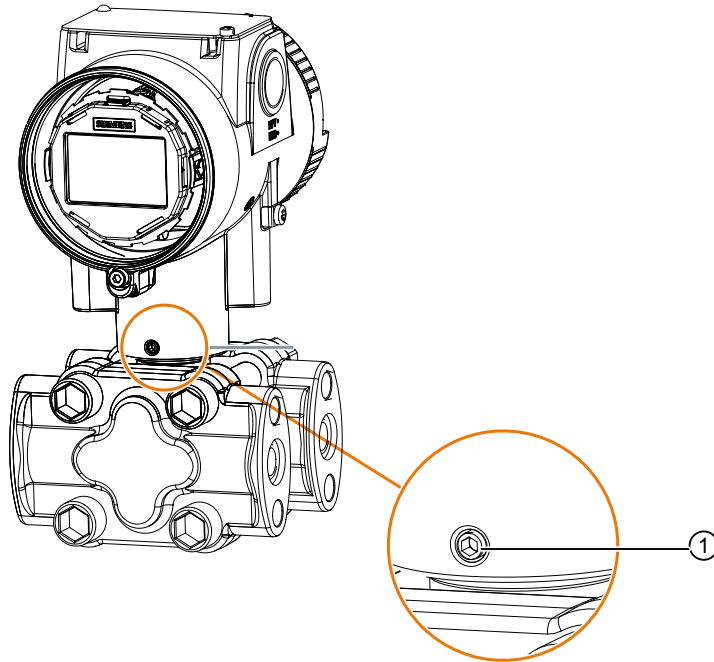

① Retaining screw

One retaining screw ① for the aluminum enclosure and two retaining screws (front and back) for the stainless steel enclosure prevent that the flat ribbon cable is damaged while rotating the enclosure.

The flat ribbon cable connects the sensor to the electronics.

The tightening torques of the retaining screws are different for the aluminum enclosure and the stainless steel enclosure. For the tightening torques of the retaining screws, refer to section Technical data (Page 163).

Tool

2.5 mm Allen key

Rotating the aluminum enclosure

1. Loosen the retaining screw ① by half a rotation.
2. Rotate the enclosure to the desired position (but no further than the end stop).
3. Tighten the retaining screw.

Rotating the stainless steel enclosure

1. Loosen the front retaining screw by half a rotation.
2. Loosen the back retaining screw by half a rotation.
3. Rotate the enclosure to the desired position (but no further than the end stop).
4. Tighten the front and back retaining screw.
To prevent the enclosure from turning in case of vibration, make sure that the front and back retaining screw are tightened.

5.10 Insert jumper

The device is delivered with a jumper.

Depending on the communication, you insert the jumper to activate the following functions:

- PROFIBUS PA:
Locking the device (Page 81)
- FOUNDATION Fieldbus:
Simulation (Page 132)

Procedure

1. De-energize the device.
2. Use a 3 mm Allen key to loosen the front safety catch.
3. Remove the front cover connector of the device.

5.10 Insert jumper

- Remove the display from the holder.

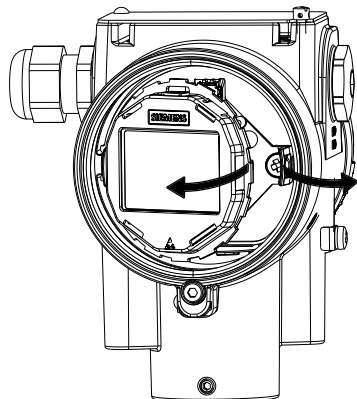

- Disconnect the cable of the display from the 4-pole connector ①.

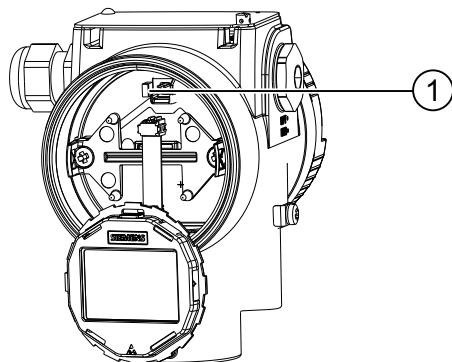

Jumper is not inserted (e.g., at time of delivery)	Jumper is inserted

5.11 Removing

 WARNING**Incorrect disassembly**

The following risks may result from incorrect disassembly:

- Injury through electric shock
- Risk through emerging media when connected to the process
- Risk of explosion in hazardous area

In order to disassemble correctly, observe the following:

- Before starting work, make sure that you have switched off all physical variables such as pressure, temperature, electricity etc. or that they have a harmless value.
- If the device contains hazardous media, it must be emptied prior to disassembly. Make sure that no environmentally hazardous media are released.
- Secure the remaining connections so that no damage can result if the process is started unintentionally.

Connecting

6.1 Basic safety instructions

 WARNING**Unsuitable cables, cable glands and/or plugs**

Risk of explosion in hazardous areas.

- Use only cable glands/plugs that comply with the requirements for the relevant type of protection.
- Tighten the cable glands in accordance with the torques specified in Technical data (Page 163).
- Close unused cable inlets for the electrical connections.
- When replacing cable glands, only use cable glands of the same type.
- After installation, check that the cables are seated firmly.

 WARNING**Improper power supply**

Risk of explosion in hazardous areas as result of incorrect power supply.

- Connect the device in accordance with the specified power supply and signal circuits. The relevant specifications can be found in the certificates, in Technical data (Page 163) or on the nameplate.

 WARNING**Incorrect conduit system**

Risk of explosion in hazardous areas as result of open cable inlet or incorrect conduit system.

- In the case of a conduit system, mount a spark barrier at a defined distance from the device input. Observe national regulations and the requirements stated in the relevant approvals.

 WARNING**Unprotected cable ends**

Risk of explosion through unprotected cable ends in hazardous areas.

- Protect unused cable ends in accordance with IEC/EN 60079-14.

 WARNING
Lack of equipotential bonding Danger of explosion through compensating currents or ignition currents through lack of equipotential bonding. For devices of intrinsic safety "db", "ec", "tb" or "tc" which are operated in a non-intrinsically safe circuit, observe the following: <ul style="list-style-type: none">• Connect the device to the system via the equipotential bonding terminal. Note: For devices of the intrinsic safety "ia", "ib" and "ic" type of protection, which are operated in an intrinsically safe circuit, connection to the system via the equipotential bonding terminal is not required.

 WARNING
Improper laying of shielded cables Risk of explosion through compensating currents between hazardous area and the non-hazardous area. <ul style="list-style-type: none">• Shielded cables that cross into hazardous areas should be grounded only at one end.• If grounding is required at both ends, use an equipotential bonding conductor.

 WARNING
Connecting or disconnecting device in energized state Risk of explosion in hazardous areas. <ul style="list-style-type: none">• Connect or disconnect devices in hazardous areas only in a de-energized state. Exceptions: <ul style="list-style-type: none">• Devices having the type of protection "Intrinsic safety Ex i" may also be connected in energized state in hazardous areas.

 WARNING
Incorrect selection of type of protection Risk of explosion in hazardous areas. This device is approved for various types of protection. <ol style="list-style-type: none">1. Select an intrinsic safety type of protection "ia", "ib", "ic" or non-intrinsic safety "db", "tb", "tc", "ec".2. Connect the device according to the selected type of protection.3. When operating with non-intrinsically safe power supplies, make the intrinsically safe types of protection permanently unrecognizable as in the nameplate example.

II 1/2G Ex ia IIC T4/T6 Ga/Gb II 1/2G Ex ia/db IIC T4/T6 Ga/Gb

Figure 6-1 Nameplate example: Type 7MF0..0-.....-D..-Z + E20

NOTICE**Ambient temperature too high**

Damage to cable sheath.

- At an ambient temperature ≥ 60 °C (140 °F), use heat-resistant cables suitable for an ambient temperature at least 20 °C (36 °F) higher.

NOTICE**Condensation in the device**

Damage to device through formation of condensation if the temperature difference between transportation or storage and the mounting location exceeds 20 °C (36 °F).

- Before taking the device into operation, let the device adapt for several hours in the new environment.

6.1.1 Incorrect measured values with incorrect grounding

NOTICE**Incorrect measured values with incorrect grounding**

The device must not be grounded via the "+" or "-" connection. It may otherwise malfunction and be permanently damaged.

- If necessary, ground the device using the earthing connection.

Note**Electromagnetic compatibility (EMC)**

You can use this device in industrial environments, households and small businesses.

For metal housings there is an increased electromagnetic compatibility compared to high-frequency radiation. This protection can be increased by grounding the housing, see Technical data (Page 163).

Note

Improvement of interference immunity

- Lay signal cables separate from cables with voltages > 60 V.
- Use cables with twisted wires.
- Keep device and cables at a distance from strong electromagnetic fields.
- Take account of the conditions for communication specified in the Technical data (Page 163).
- Use shielded cables to guarantee the full specification according to HART/PA/FF/Modbus/EIA-485/Profibus DP.

6.2 Connecting the device

6.2.1 Opening the device

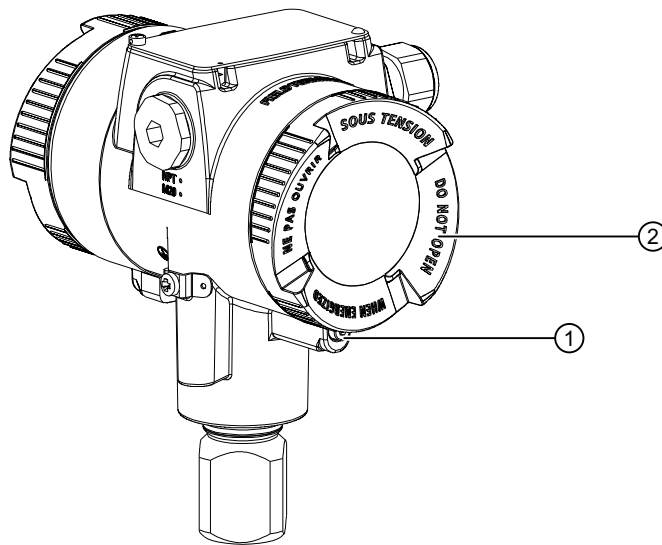

- ① Safety catch (optional)
- ② Cover of the electrical cable compartment.

Figure 6-2 Rear view of pressure transmitter

1. Use a 3 mm Allen key to loosen the safety catch ①.
2. Unscrew the cover of the electrical cable compartment ②.

6.2.2 Connecting the device

Procedure

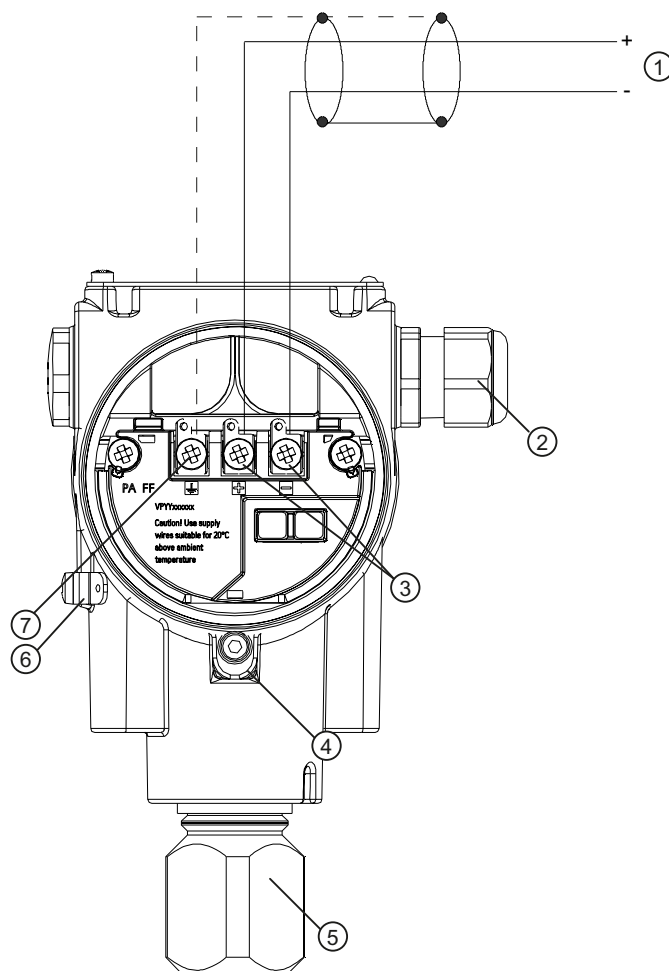

- | | |
|------------------------|---|
| ① Fieldbus | ⑤ Process connection |
| ② Cable gland | ⑥ Protective conductor connector/equipotential bonding terminal |
| ③ Connecting terminals | ⑦ Ground terminal |
| ④ Safety catch | |

1. Connect the device to the system via the existing protective conductor connection ⑥ and observe the torque while doing so.
 - Use a cable with a diameter of 1 ... 4 mm².
2. Insert the connecting cable through the cable gland ②.
3. Connect the wires to the connection terminals ③ "+" and "-", observing the torque while doing so¹.
 - Use wires with a diameter of 0.5 ... 2.5 mm².
 - If you use stranded wire, you need ferrules.

6.2 Connecting the device

4. Apply the shield to the screw of the ground terminal ⑦.
The screw of the ground terminal is electrically connected to the external protective conductor connection.
5. For devices with intrinsically safe protection type, use a supply unit that corresponds to the requirements of the relevant type of protection.

See also

Torques (Page 203)

6.2.3 Closing the device

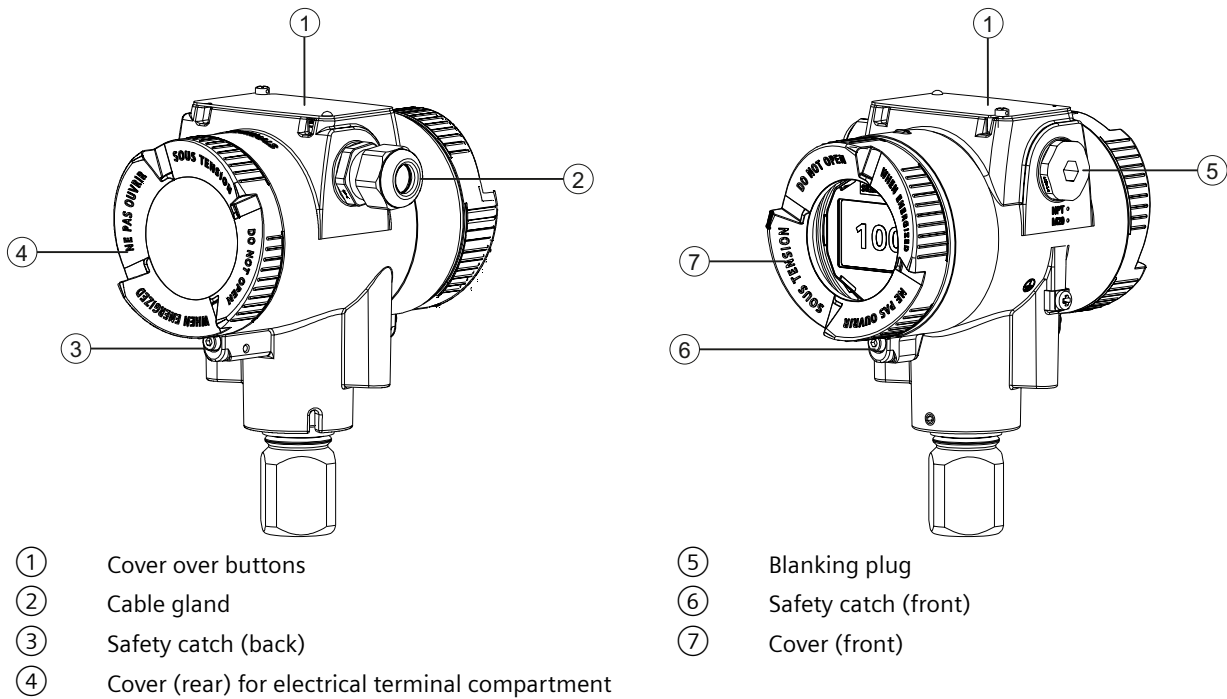

Figure 6-3 View of the pressure transmitter: Left: Back right: Front view

1. Screw on the cover ④ and ⑦ as far as it will go.
Make sure that there is no gap between enclosure and cover.
2. Secure each cover with the cover catch ③ and ⑥ by removing the screw.
For the aluminum enclosure, observe the torque (Page 203).
3. Close the cover over the buttons ①.
4. Tighten the screw for the cover over the buttons.

6.3 Connect the Han cable socket to the cable

WARNING

Loss of the safety required for approval by using the Han plug

You may only use the Han plug for non-Ex devices and for devices with intrinsic safety "Ex i"; otherwise, the safety required for the approval is not guaranteed.

Note

Observe the protection class of the Han plug when defining the protection class.

The contact parts for the cable socket are supplied.

For devices with a Han plug mounted on the enclosure, make the connection via the cable socket.

Requirement

- The terminal area of the cable socket is suitable for cables with diameters ranging from 6 to 12 mm.
- These cables use stranded wires with 1 mm² as single conductors ("+", "-" and ground).
- You are using a crimping tool from HARTING (article number 09 99 000 0110).

Procedure

1. Slide the sleeve and the screwed joint on the cable.
2. Strip approx. 8 mm of the cable ends.
3. Crimp the contact parts on the cable ends.
4. Assemble the cable socket.

Connector pin assignment with Han 7D or Han 8D plug or cable socket

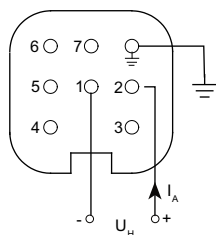

I_A Output current
 U_H Auxiliary power

6.4 Connect M12 cable socket to the cable

⚠ WARNING
Loss of safety required for approval by using the M12 device plug.
You may only use the plug for non-Ex devices; otherwise, the safety required for the approval is not guaranteed.

Note

A conductive connection must not exist between the shield and the connector housing.

Note

Observe the protection class of the M12 device plug when defining the protection class.

In devices where a plug is already mounted on the enclosure, the connection is made via a cable socket.

1. Thread the parts of the cable socket as described by the manufacturer of the cable socket.
2. Strip approximately 18 mm of the bus cable ①.
3. Twist the shield.
4. Thread the shield in the insulating sleeve.
5. Draw 8 mm of shrink sleeve over the cable, wires and shield up to the reference edge ②.
6. Screw the cable ends and the shield in the pin insert.
7. Fasten the parts of the cable socket as described by the manufacturer.

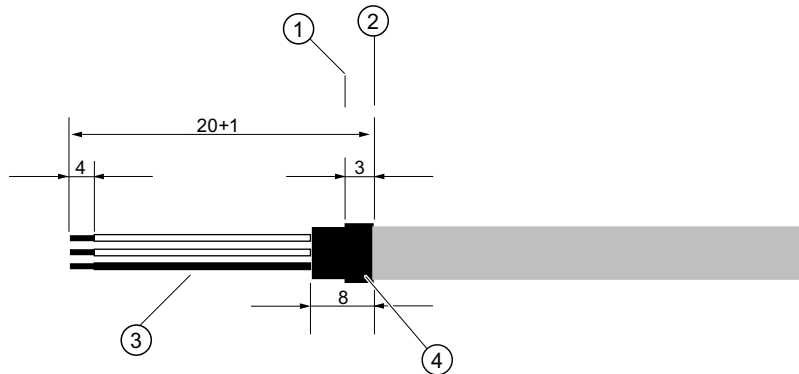
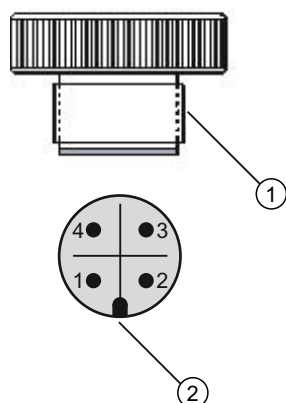

Figure 6-4 Preparing the connecting cable

- | | |
|--|-------------------------------------|
| ① Reference edge for stripping | ③ Insulating sleeve over the shield |
| ② Reference edge for the dimension specifications for cable assembly | ④ Shrink sleeve |

Assignment



Layout for M12 device plug

- ① M12 x 1 thread
- ② Positioning catch
- 1 +
- 2 Not connected
- 3 -
- 4 Shield

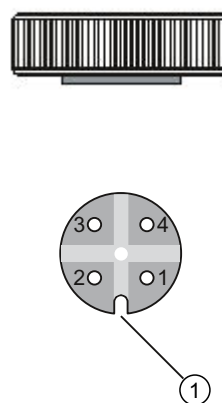

Assignment diagram M12-cable socket

- ① Positioning slot
 - 1 +
 - 2 Not connected
 - 3 -
 - 4 Shield
- Middle contact of the cable socket not connected

6.5 Switching on the supply voltage

Procedure

1. Connect the device. (Page 69)
2. Switch on the supply voltage.
 - Product name and firmware version appear briefly on the display.
 - The measured values are shown on the local display or via remote operation (e.g. SIMATIC PDM).

Operating

You operate the device using the buttons.

If you have a device with a display, you can view the measured values, parameter values and messages.

If you have a device without a display, you also have several functions available:

Commissioning the device (PROFIBUS PA) (Page 86)

7.1 Buttons

The four buttons are located below the cover:

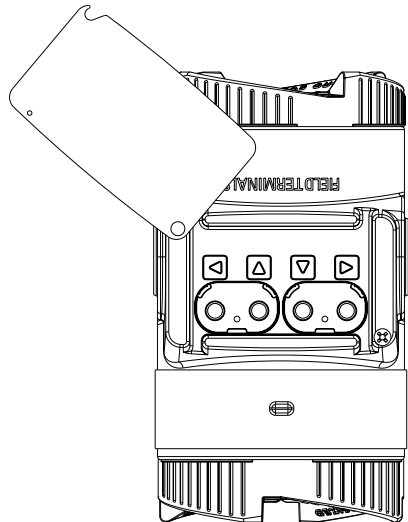

Figure 7-1 Top view

7.2 Operating the device with display

7.2.1 Navigating in the views

You navigate in the views with the buttons:

Buttons (Page 75)

Example

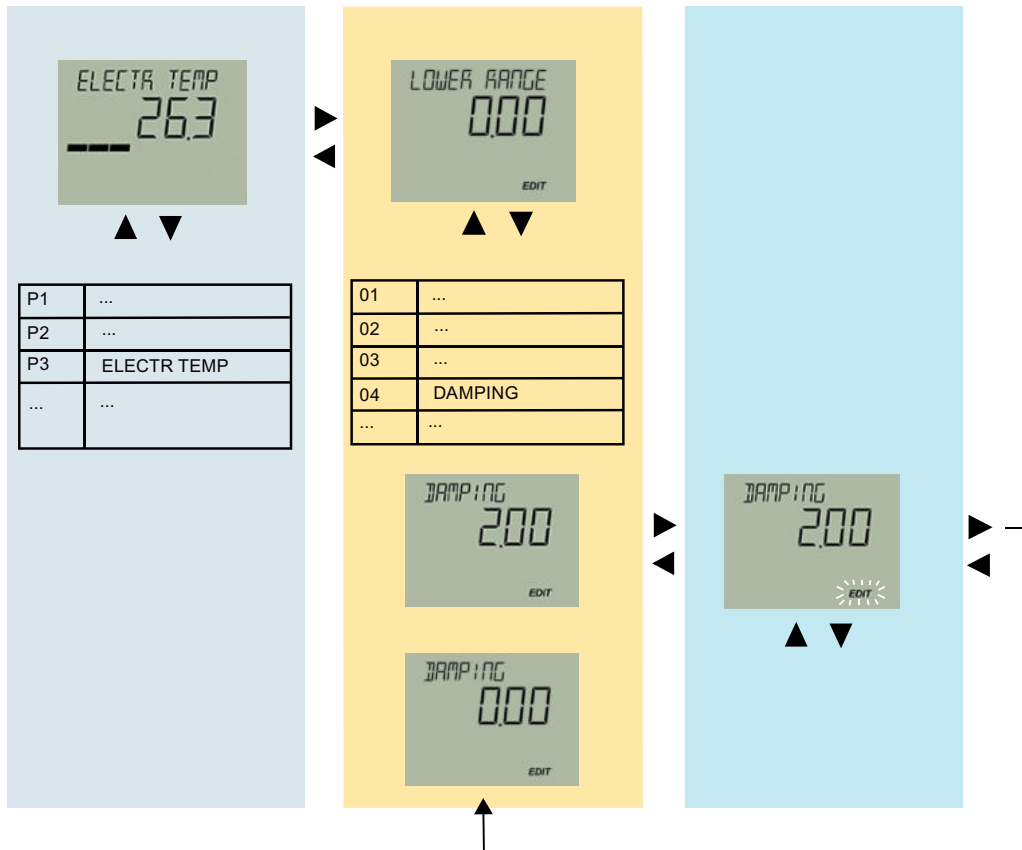

Figure 7-2 The colors represent three different views: Measured value view, parameter view and edit view

7.2.2 Measurement view

The measurement view shows the current measured values as well as the device status:

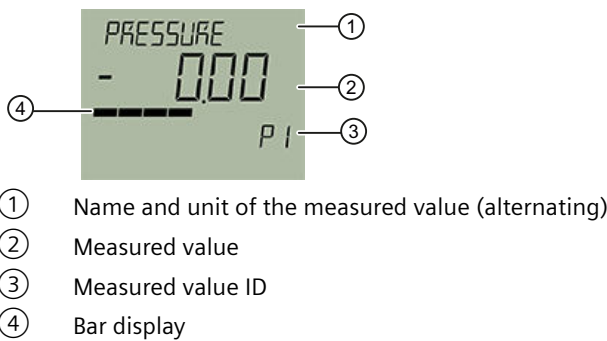

Figure 7-3 Example of measurement view

① shows the name of the measured value and the set unit as alternating values.

Measured value IDs ③ start with "P".

The bar display shows the following information:

- The position of a measured value within the set measuring span¹⁾.
- The position of the temperature value within the sensor limits.
- The scaling of the process values calculated from the pressure value (e.g. volume flow).

¹⁾ Nominal measuring range for PROFIBUS PA and FOUNDATION Fieldbus

7.2.2.1 Display of measured values

The following information is displayed depending on the configuration and communication:

Measured value ID	Name of measured value	Meaning
P1	PRESSURE	Pressure
	PRESS GAUGE	Gauge pressure
	PRESS ABS	Absolute pressure
P2	SENSOR TEMP	Sensor temperature
P3	ELECTR TEMP	Electronics temperature
P4	LEVEL	Level
P5	VOLUME	Volume
P6	VOLUME FLOW	Volume flow
P7	MASS FLOW	Mass flow
P8	USER DEFINED	Customized characteristic curve
P9	% OF RANGE	Percent of range
PA	TOTALIZER	Totalizer for mass flow
PB	TOTALIZER	Totalizer for volume flow

You use the "Start view" parameter [32] to select the measured value that is displayed as the first measured value in the measurement view.

7.2.2.2 Navigating in the measurement view

Requirement

You have disabled the button lock.

Disabling button lock (Page 119)

Procedure

1. Use the ▲ and ▼ buttons to navigate in the measurement view.
2. To switch to the parameter view, press the ► button.

7.2.3 Parameter view

The parameter view shows the parameters, parameter values and the wizards of the device.

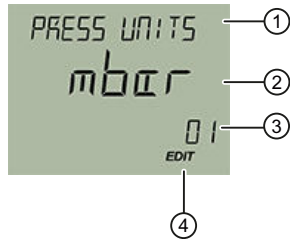

- ① Name and unit of the parameter (alternating)
- ② Parameter value
- ③ Parameter ID
- ④ "EDIT" symbol (permanently enabled)

Figure 7-4 Example of parameter view

For parameters with an associated unit, the parameter name and unit are displayed as alternating values in ①. Example: Pressure units in mbar.

7.2.3.1 List of parameters on the display

The parameters are displayed with parameter ID and parameter name.

Depending on the communication and the parameter settings of your device, some parameters are hidden.

For devices with FOUNDATION Fieldbus, fewer parameters are available on the display.

ID	Parameter name	PA	FF	Meaning
01	PRESS UNITS	•		Set the pressure unit.
02	LOW IN SCALE	•		Set the lower input scaling point of the process value. Is used for the measurement of the process values calculated from the measured pressure value.
03	UP IN SCALE	•		Set the upper input scaling point of the process value. Is used for the measurement of the process values calculated from the measured pressure value.
04	DAMPING	•		Sets the damping (filtering) for smoothing of sudden process value variations.
05	APPLICATION	•		Application ¹⁾ ; sets the device for a specific measuring task.
06	SQRT POINT	•		Provides the application point for volume and mass flow (VSLN and MSLIN).
07	ZERO POINT	•		Sets the zero point.
16	LEVEL UNITS	•		Sets the level unit.
16	VOL UNITS	•		Sets the volume unit.
16	VFLOW UNITS	•		Sets the volume flow unit.
16	MFLOW UNITS	•		Sets the mass flow unit.
17	TEMP UNITS	•		Sets the temperature unit for sensor and electronics temperature.

ID	Parameter name	PA	FF	Meaning
18	LOWER SCALNG	•		Set the lower output scaling point of the process value. Is used for the measurement of the process values calculated from the measured pressure value.
19	UPPER SCALNG	•		Sets the upper output scaling point of the process value. Is used for the measurement of the process values calculated from the measured pressure value.
20	LOW FLOW CUT	•		Sets the flow limit for the low flow cut-off. Flow rate values below this limit are set to zero.
21	VESSEL DIM A	•		Vessel dimension A; sets the height of the vessel bottom for specific vessel shapes.
22	VESSEL DIM L	•		Vessel dimension L; sets the length of the vessel bottom for a lying parabolic ends vessel.
23	BUTTON LOCK	•	•	Disables access to the device buttons. With activated button lock, the device can only be operated over the engineering system.
24	CHG USER PIN	•		Used to change PIN code that enables user access level.
25	RECOVERY ID	•		Displays the recovery ID. It must be made available to the technical support team to receive the PUK (PIN Unlock Key) required to restore the PIN(s).
26	PIN RECOVERY	•		Used for input of the PIN Unlock Key (PUK) to reset the PIN(s) to factory setting. The PUK is available from the technical support team. The user PIN 2457 is factory preset in the device.
27	USER PIN	•		Used to enable or disable the user PIN.
30	DISPLAY TEST	•	•	Used to check that numbers, texts and symbols appear correctly on the display.
32	START VIEW	•	•	Sets the process value shown first on the display after power on.
33	PRESSURE REF	•	•	Used to adapt the display of the pressure unit to your application (e.g. gauge pressure or absolute pressure).
35	RESET	•	•	Used to reset specific settings.
37	FW VERSION	•	•	Displays FW version of the device.
38	CONFIG COUNT	•	•	Displays number of times device configuration or calibration changed, locally or via engineering system.
40	SLAVE ADDR	•		Sets the bus address of the device on the fieldbus.
41	GSD SELECT	•		Sets the GSD file.
42	ACTIVE GSD	•		Displays the set GSD file.

1) The "Application" parameter is also called the "Transfer function" in certain configuration tools.

Hereinafter, the parameter ID is always written inside parentheses after the parameter name.

Example: Parameter "Damping value" [04].

7.2.3.2 Navigating in the parameter view

Requirement

The button lock is disabled.

Disabling button lock (Page 119)

Procedure

1. Use the ▲ or ▼ buttons to navigate within the parameters.
To navigate faster, keep the ▲ or ▼ button pressed.
After the last parameter, you jump to the first parameter, and vice versa.
2. To switch to edit view, press the ► button.
3. To return to the measurement view, press the ◀ button.

7.2.4 Edit view

You change the parameter values in the edit view. Wizards are available for specific parameters.

Parameter values

There are various parameter values:

- Enumerations (e.g. unit)
- Numerical values (e.g. damping)

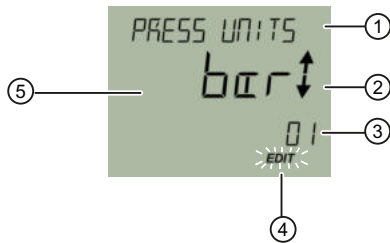

- | | |
|---|----------------------------|
| ① Name of parameter and, if available, unit (alternating) | ④ "EDIT" symbol (flashing) |
| ② Enumeration arrows (for enumerations only) | ⑤ Parameter value |
| ③ Parameter ID | |

Figure 7-5 Example of edit view

For parameters with an associated unit, the parameter name and unit are displayed as alternating values in ①. Example: Pressure units in mbar.

7.2.4.1 Changing parameter values

Requirement

- The device is not write-protected.
- For information on write protection, refer to section Locking the device (Page 81).

Procedure

1. Navigate to the parameter view (Page 75).
2. Select the desired parameter with the ▲ or ▼ button.
Use the ► button to confirm.
You are in the edit view.
3. Change the parameter value with the ▲ or ▼ button.
To navigate faster, keep the ▲ or ▼ button pressed.
4. Save the change with the ► button.
Or, cancel the change with the ◀ button.

7.2.5 Device status display

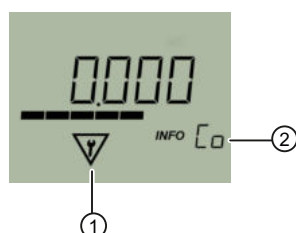

- ① Symbol - NAMUR NE 107
- ② Diagnostics ID

Figure 7-6 Example

For additional information about symbols and the diagnostic messages, refer to Diagnostics and troubleshooting (Page 151).

7.3 Locking the device

Depending on the communication, the following options are available to lock the device:

- Enable write protection via jumper (PROFIBUS PA) (Page 82)
- Enable write protection using the user PIN (PROFIBUS PA) (Page 123)
- Enable write protection via button lock (PROFIBUS PA and FOUNDATION Fieldbus) (Page 83)
- Write protection via "Write lock" parameter in the Resource Block (FOUNDATION Fieldbus)

Write protection is displayed with the  symbol on the display.

Write protection	ID	Read measured values on the display	Read parameters on the display	Change parameters via the device with display	Change parameters via communication
Jumper set (only with PROFIBUS PA)	L	Yes	No	No	No
User PIN ¹⁾ enabled (only with PROFIBUS PA)	LP	Yes	Yes	Yes, after input of the user PIN	Yes, after input of the user PIN

7.3 Locking the device

Write protection	ID	Read measured values on the display	Read parameters on the display	Change parameters via the device with display	Change parameters via communication
Button lock enabled	LL	Yes	No	No	Yes
"Write protection (Write lock)" parameter enabled in the Resource Block (only with FOUNDATION Fieldbus)	L	Yes	No	No	No

¹⁾The user PIN is factory set to 2457 in the device. When delivered, write protection is disabled using the user PIN.

7.3.1 Enable write protection with jumper (only with PROFIBUS PA)

With PROFIBUS PA, the jumper is used for enabling write protection.

When the jumper is inserted:

- Measured values are read-only.
- The display changes automatically between the measured values.
- Operation via the buttons is disabled.

To enable write protection, you insert the jumper:

Insert jumper (Page 61)

7.3.2 Enable user PIN

Requirement

The User PIN is disabled.

Procedure

1. Navigate to the parameter view.
Navigating in the views (Page 75)
2. Select the parameter "User PIN".
3. Use the  button to confirm.
The message "USER PIN ON" (User PIN enabled) appears for 2 seconds.

Result

The User PIN is activated after about 10 minutes or after a device restart.



See also

Disable user PIN (Page 124)

7.3.3 Enabling button lock

Procedure

1. Navigate into the parameter view.
Navigating in the views (Page 75)
2. In the parameter view, select the "Button lock" parameter.
3. Press the ► button.
The "EDIT" symbol flashes.
4. Select ON with the ▲ or ▼ button.



5. Use the ► button to confirm.

Result

- The display automatically returns to the measurement view.
- The display automatically changes between the measured values every 12 seconds.
- The symbol for button lock "LL" and the measured value ID are displayed alternately.

Note

For a device without display, you activate the button lock using remote operation.

See also

Disabling button lock (Page 119)

7.3.4 Write protection with "Write lock" parameter (FOUNDATION Fieldbus)

1. Connect to the device via remote operation.
2. In the Resource Block, enable the write protection: "Write Lock > Locked".
 - Measured values are read-only.
 - The display changes automatically between the measured values.
 - Operation via the buttons is disabled.

To disable write protection, set the "Write Lock" parameter to "Not Locked".

Commissioning

8.1 Basic safety instructions

 DANGER
<p>Toxic gases and liquids</p> <p>Danger of poisoning when venting the device: if toxic process media are measured, toxic gases and liquids can be released.</p> <ul style="list-style-type: none">• Before venting ensure that there are no toxic gases or liquids in the device, or take the appropriate safety measures.

 WARNING
<p>Improper commissioning in hazardous areas</p> <p>Device failure or risk of explosion in hazardous areas.</p> <ul style="list-style-type: none">• Do not commission the device until it has been mounted completely and connected in accordance with the information in Technical data (Page 163).• Before commissioning take the effect on other devices in the system into account.

 WARNING
<p>Commissioning and operation with pending error</p> <p>If an error message appears, correct operation in the process is no longer guaranteed.</p> <ul style="list-style-type: none">• Check the gravity of the error.• Correct the error.• If the error still exists:<ul style="list-style-type: none">– Take the device out of operation.– Prevent renewed commissioning.

 WARNING
<p>Loss of explosion protection</p> <p>Risk of explosion in hazardous areas if the device is open or not properly closed.</p> <ul style="list-style-type: none">• Close the device as described in Technical data (Page 163).

 WARNING
Opening device in energized state Risk of explosion in hazardous areas <ul style="list-style-type: none">• Only open the device in a de-energized state.• Check prior to commissioning that the cover, cover locks, and cable inlets are assembled in accordance with the directives. Exception: Devices having the type of protection "Intrinsic safety Ex i" may also be opened in energized state in hazardous areas.

Note

Hot surfaces

Hot process medium and high ambient temperatures lead to hot surfaces which can cause burns.

- Take corresponding protective measures, for example wear protective gloves.
-

 WARNING
Hazardous contact voltage Risk of injury through hazardous contact voltage when the device is open or not completely closed. The degree of protection specified on the nameplate or in Technical data (Page 163) is no longer guaranteed if the device is open or not properly closed. <ul style="list-style-type: none">• Make sure that the device is securely closed.

8.2 Commissioning the device (PROFIBUS PA)

Before you commission the device

Integrate the current EDD (Electronic Device Description) of your device into the device catalog of your parameter assignment tool.

- The GSD file of the device is contained in the EDD zip file.
- You can find a detailed description of how you locate and integrate the EDD in the section Updating the Electronic Device Description (EDD) (Page 224).

Commissioning via the local operation

1. Change the default bus address "126" with the parameter "SLAVE ADDR".
If you have configured the bus address via your order, this step is not necessary.
2. Set the "GSD SELECT" parameter to "Auto".
For the device to automatically apply the configuration in the control system, set the parameter to "Auto".
The device thus automatically adapts to a valid network configuration, for example, in SIMATIC STEP 7 HW Config.
More information on the various GSD files is available in the section GSD SELECT [41] (Page 127).
3. Set the parameters you need for your application on the device or with a parameter assignment tool (e.g. SIMATIC PDM).
List of parameters on the display (Page 78)
Parameter assignment over remote operation (Page 130)

Note

Commissioning a device without a display

All commissioning steps mentioned above are performed via remote operation.

You set the zero point by pressing the buttons ▲ and ▼ for three seconds.

8.3 Commissioning the device (FOUNDATION Fieldbus)

Introduction

Various tools are available for commissioning via FOUNDATION Fieldbus.

You will find an overview of compatible tools in the section Product compatibility (Page 14).

General procedure

1. Connect the device.
2. Download the latest EDD to the parameterization tool.
3. Open the configuration view of your parameterization tool.
The device is displayed with product name and serial number.

4. During first initialization of the device in the parameterization tool, change the bus address:
 - Factory setting: 248
 - Setting range: 16 - 247

Note

When it detects another device with the same bus address, the device automatically sets its bus address to one of the temporary addresses between 248 and 251.

5. Configure the device blocks:
 - Resource Block
 - Pressure Transducer Block
 - 3 Analog Input function blocks (AI function blocks).
 - PID function block

For more information on the block model, refer to the section FOUNDATION Fieldbus communication (Page 227).

Note

Device without display: Set zero point

You set the zero point by pressing the buttons ▲ and ▼ for three seconds.

8.4 Application examples

8.4.1 Gauge pressure, absolute pressure from differential pressure series, and absolute pressure from gauge pressure series

8.4.1.1 Commissioning in gaseous environments

Requirement

All valves are closed.

Procedure

A

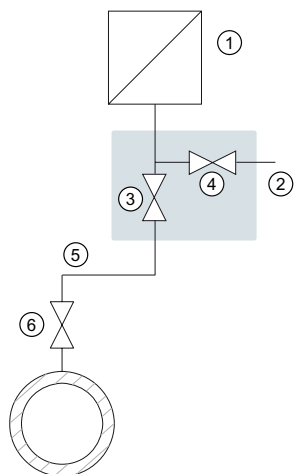

B

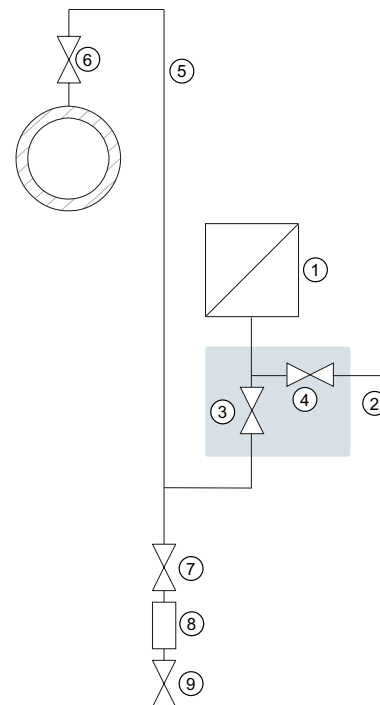

A Pressure transmitter above the pressure sampling point

- ① Pressure transmitter
- ② Shut-off valve
- ③ Shut-off valve to process
- ④ Shut-off valve for test connection or for bleed screw
- ⑤ Pressure line

B Pressure transmitter below the pressure sampling point

- ⑥ Shut-off valve
- ⑦ Shut-off valve (optional)
- ⑧ Condensate vessel (optional)
- ⑨ Blowout valve

1. Open the shut-off valve for the test connection ④.
2. Via the test connection of the shutoff valve ②, apply the pressure corresponding to the lower range value to the pressure transmitter.
3. Ensure that the lower range value corresponds to the desired value. Otherwise, correct the value.
4. Close the shut-off valve for the test connection ④.
5. Open the shut-off valve ⑥ at the pressure tapping point.
6. Open the shut-off valve for the process ③.

8.4.1.2 Commissioning with steam or liquid

Requirement

All valves are closed.

Procedure

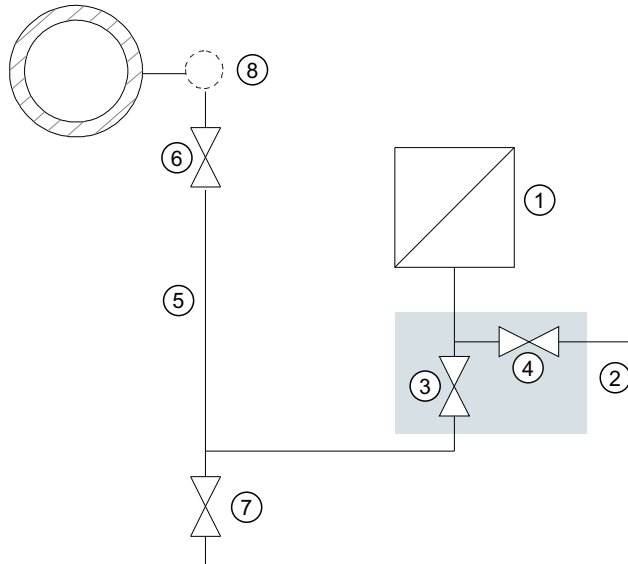

- ① Pressure transmitter
- ② Shut-off valve
- ③ Shut-off valve to process
- ④ Shut-off valve for test connection or for bleed screw
- ⑤ Pressure line
- ⑥ Shut-off valve
- ⑦ Drain valve
- ⑧ Compensation vessel (steam only)

1. Open the shut-off valve for the test connection ④.
2. Via the test connection of the shutoff valve ②, apply the pressure corresponding to the lower range value to the pressure transmitter.
3. Ensure that the lower range value corresponds to the desired value. Otherwise, correct the value.
4. Close the shut-off valve for the test connection ④.
5. Open the shut-off valve ⑥ at the pressure tapping point.
6. Open the shut-off valve for the process ③.

8.4.2 Differential pressure and flow rate

8.4.2.1 Commissioning in gaseous environments

Requirement

All shut-off valves are closed.

Procedure

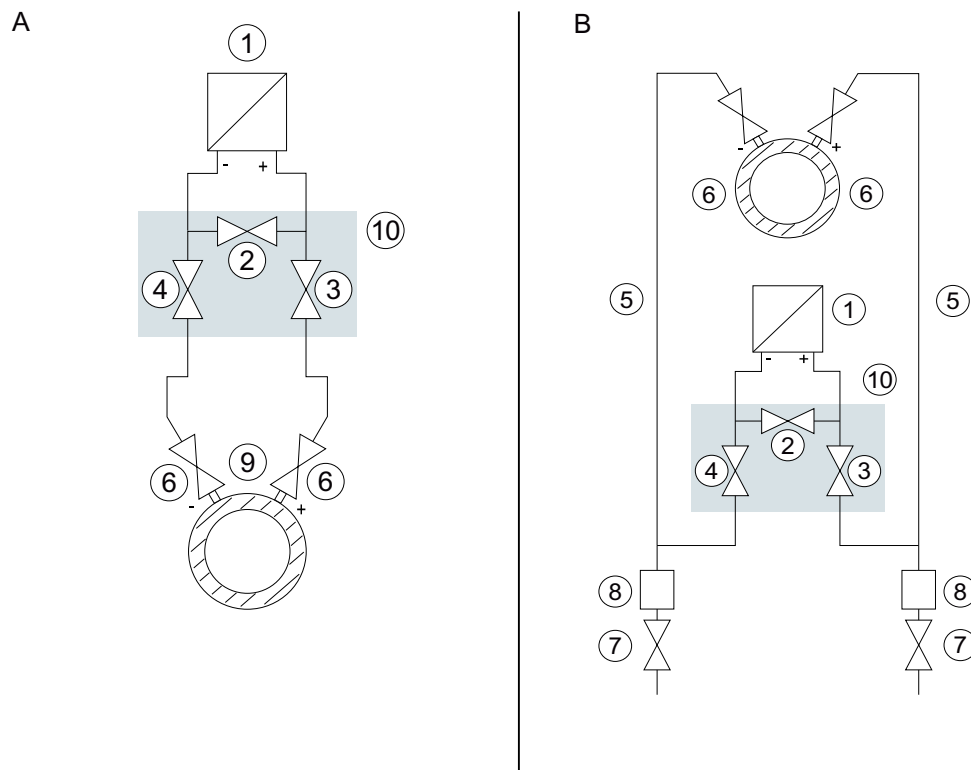

A Pressure transmitter above the differential pressure transducer

- ① Pressure transmitter
- ② Stabilizing valve
- ③, ④, Differential pressure valves
- ⑤ Differential pressure lines
- ⑥ Shut-off valves

B Pressure transmitter below the differential pressure transducer

- ⑦ Blowout valves
- ⑧ Condensate vessels (optional)
- ⑨ Differential pressure transducer (e.g. FPS200 and FPS300)
- ⑩ 3-way valve manifold

1. Open both the shut-off valves ⑥ at the pressure tapping point.
2. Open the stabilizing valve ②.
3. Open the differential pressure valve (③ or ④).
4. Check and, if necessary, correct the zero point when the lower range value is 0 bar (4 mA).

5. Close the stabilizing valve ②.
6. Open the other differential pressure valve (③ or ④).

8.4.2.2 Commissioning for liquids

Requirement

All valves are closed.

 DANGER
Toxic liquids
Danger of poisoning when the device is vented.
If toxic process media are measured with this device, toxic liquids can escape when the device is vented.
<ul style="list-style-type: none">• Before venting, make sure there is no liquid in the device or take the necessary safety precautions.

Procedure

A

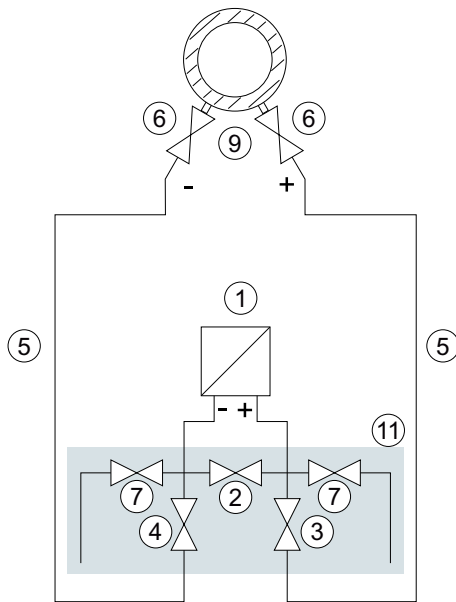

B

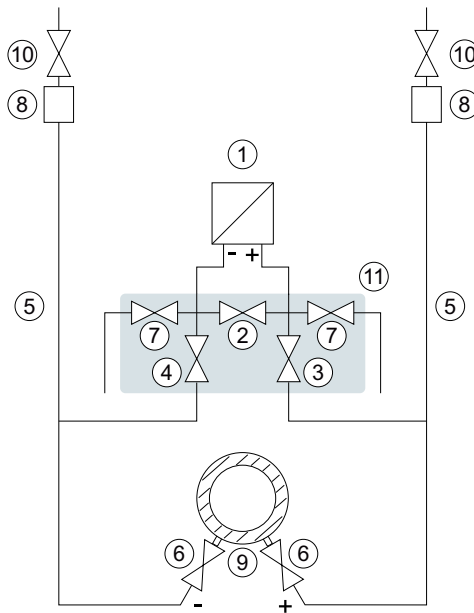

A	Pressure transmitter below the differential pressure transducer	B	Pressure transmitter above the differential pressure transducer
①	Pressure transmitter	⑦	Drain valves
②	Stabilizing valve	⑧	Gas collector vessels (optional)
③, ④	Differential pressure valves	⑨	Differential pressure transducer
⑤	Differential pressure lines	⑩	Vent valves
⑥	Shut-off valves	⑪	5-way valve manifold

1. Open both the shut-off valves ⑥ at the pressure tapping point.
2. Open the stabilizing valve ②.
3. With **pressure transmitters below the differential pressure transducer**, partially open both drain valves ⑦ one after the other until liquid emerges without bubbles.
In the case of a **pressure transmitter above the differential pressure transducer**, partially open both vent valves ⑩ one after the other until liquid emerges without bubbles.
4. Close both drain valves ⑦ or vent valves ⑩.
5. Partially open the differential pressure valve ③ and the vent valve (sealing plug with vent valve) on the positive side of the pressure transmitter until liquid escapes without bubbles.
6. Close the vent valve (sealing plug with vent valve).
7. Partially open the vent valve (sealing plug with vent valve) on the negative side of the pressure transmitter until liquid escapes without bubbles.
8. Close the differential pressure valve ③.

9. Partially open the differential pressure valve ④ until liquid escapes without bubbles.
10. Close the differential pressure valve.
11. Close the vent valve (sealing plug with vent valve) on the negative side of the pressure transmitter.
12. Open the differential pressure valve ③ with half a revolution.
13. For a lower range value of 0 bar, check the zero point (4 mA) and correct the lower range value if it is different.
14. Close the stabilizing valve ②.
15. Open the differential pressure valves (③ and ④) completely.

8.4.2.3 Commissioning with vapor

Requirement

All valves are closed.

 **WARNING**

Hot vapor

Danger of injury or damage to device.

If the shut-off valves ⑥ and the differential pressure valve ③ are both open and the stabilizing valve ② is then opened, the pressure transmitter ① can be damaged by the flow of vapor.

- Follow the specified procedure for commissioning.

 **WARNING**

Hot vapor

Danger of injury.

You can briefly open the drain valves ⑦ to clean the line. Hot vapor can escape in the process.

- Only open the drain valves ⑦ briefly, and close them again before vapor escapes.

Procedure

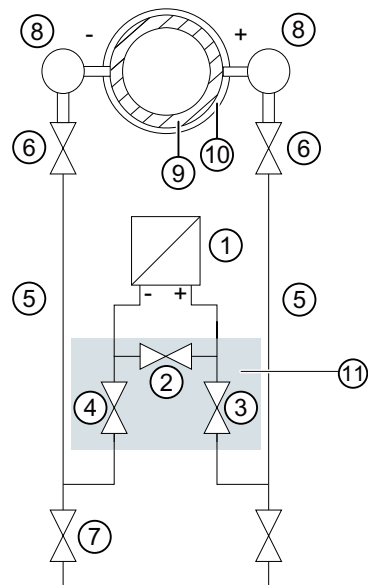

- | | | | |
|----|------------------------------|---|----------------------------------|
| ① | Pressure transmitter | ⑦ | Drain valves |
| ② | Stabilizing valve | ⑧ | Condensate pots |
| ③, | Differential pressure valves | ⑨ | Differential pressure transducer |
| ④ | | ⑩ | Insulation |
| ⑤ | Differential pressure lines | ⑪ | 3-way valve manifold |
| ⑥ | Shut-off valves | | |

1. Open both the shut-off valves ⑥ at the pressure tapping point.
2. Open the stabilizing valve ②.
3. Wait until the steam in the differential pressure lines ⑤ and in the equalizing vessels ⑧ has condensed.
4. Partially open the differential pressure valve ③ and the vent valve (sealing plug with vent valve) on the positive side of the pressure transmitter until condensate escapes without bubbles.
5. Close the vent valve (sealing plug with vent valve).
6. Partially open the vent valve (sealing plug with vent valve) on the negative side of the pressure transmitter until condensate escapes without bubbles.
7. Close the differential pressure valve ③.
8. Partially open the differential pressure valve ④ until condensate escapes without bubbles.
9. Close the vent valve with blanking plug on the negative side ①.
10. Close the differential pressure valve.
11. Open the differential pressure valve ③ by half a revolution.

8.4 Application examples

12. For the lower range value 0 bar, check the zero point (4 mA).
If the differential pressure lines ⑤ have equally high condensate columns with the same temperature, the measurement result is error-free. Otherwise, repeat the zero-point adjustment.
13. Close the stabilizing valve ②.
14. Fully open the differential pressure valves ③ and ④.

Cleaning process cable

1. To clean the line, briefly open the drain valves ⑦.
2. Close the drain valve ⑦ before vapor escapes.

Parameter assignment

Introduction

You can operate the device via local operation or remote operation (e.g. SIMATIC PDM).

- The parameters that you can reach over the device with a display are marked by the parameter ID. Hereinafter, the parameter ID is always written inside parentheses after the parameter name. Example: Parameter "Damping value" [04].
- You can access the complete number of parameters via remote operation. The device-specific parameters are available in each tool for configuration. The instructions or online help for these tools will provide you with information on how to use the different tools for parameter assignment.

9.1 Parameter assignment over device with display

Introduction

This section describes all parameters that you can reach over the device with a display.

You will find information on operating the device with display in the section Operating the device with display (Page 75).

You can find the list of available parameters with ID and parameter name in the section List of parameters on the display (Page 78).

9.1.1 Pressure units [01]

With the "Pressure units" [01] parameter, you select the unit of the "Pressure" (P1) measured value that is displayed in the measurement view.

You can find a description of the pressure units that you can set in the section Display of the pressure units (Page 98).

With the "Pressure reference" parameter [33], you adapt the display of the pressure units to your application, if necessary (absolute pressure or gauge pressure).

Both parameters are available using a local operation or over the remote operation.

Example

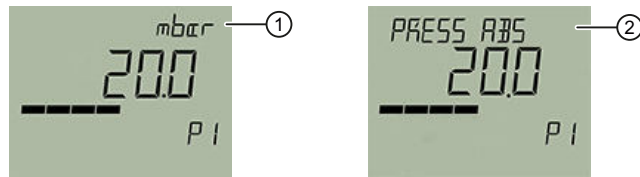

Pressure units ① and Pressure reference ② (alternating)

See also

Pressure reference [33] (Page 125)

9.1.1.1 Display of the pressure units

Certain units are displayed differently on the display and over remote operation.

Example: Display of unit "mmH₂O" on the display



Unit ① in the title bar

Unit ② as enumeration







Setting range:	Display (header line)	Display (enumeration)	Remote operation
	mbar	mbar	mbar
	bar	bar	bar
	Pa	Pa	Pa
	KPa	KPa	KPa
	MPa	MPa	MPa
	PSI	PSI	psi
	G/cm2	G/cm2	g/cm ²
	KG/cm2	KG/c2	kg/cm ²
	KGF/cm2	KF/c2	kgf/cm ²
	mmH2O	mmW68	mmH ₂ O
	mH2O (4 °C)	mmW4	mH ₂ O (4 °C)
	inH2O (68 °F)	inW68	inH ₂ O (68 °F)
	inH2O (4 °C)	inW4	inH ₂ O (4 °C)
	mmHG	mmHG	mmHg
	inHG	inHG	inHg
	hPa	hPa	hPa
	atm	atm	atm
	torr	torr	torr
Factory setting:	Depending on the measuring cell, mbar or bar, or as specified in the order		

9.1.1.2 Setting the pressure units

Requirement

You know the parameter values for the "Pressure units" parameter. (Page 98)

Procedure

1. Navigate to the parameter view.
Navigating in the views (Page 75)
2. Select the "Pressure units" parameter [01].
3. Press the  button.
4. Select the desired unit with the  or  button.
The pressure measurement is converted to the new pressure unit.
5. Use the  button to confirm.
6. Navigate to the "Pressure reference" parameter [33].
7. Press the  button.
8. Select the specific pressure unit for your application (absolute pressure, gauge pressure, none) with the  or  button.

9.1 Parameter assignment over device with display

Result

- The selected pressure unit and pressure reference are displayed as alternating values in the measurement view.
- If the converted pressure measurement has more than 5 digits, "#####" appears in the measurement view: Adjust the unit so that a lower value is displayed, e.g. bar instead of mbar.

Note

Changing the units during cyclic operation

In PROFIBUS PA, the measured value without unit is transferred immediately to the control system during cyclic operation.

If you change the unit on the display or via the parameter assignment tool during cyclic operation, the converted measured value without unit is transferred immediately.

- Example: When you change the unit on the display from 1 bar to 1 000 mbar, 1 000 bar is displayed in the control system instead of 1 000 mbar.
-

9.1.2 Lower input scaling point [02]

Sets the lower input scaling point for the measurement of derived process values (e.g. level).
This parameter is hidden when you have selected the characteristic "Pressure: Linear" (PRESS) via the parameter "Application" [05].

9.1.3 Upper input scaling point [03]

Sets the upper input scaling point for the measurement of derived process values (e.g. level).
This parameter is hidden when you have selected the characteristic "Pressure: Linear" (PRESS) via the parameter "Application" [05].

9.1.4 Damping value [04]

Sets the damping (filtering) for smoothing of sudden process value variations.

Setting range:	0.01 s ... 100 s in increments of 0.01 s
Factory setting:	2 s, or as specified in order

The damping influences the response time of the device: When you increase the damping value, the response time of the pressure transmitter to changes in the pressure measurement increases.

- Reduce the damping value for faster response times. Specify a value that meets the requirements regarding signal stability and response time.

9.1.4.1 Set damping value

Procedure

1. Navigate to the parameter view.
Navigating in the views (Page 75)
2. Select the "Damping value" parameter.
3. Press the ► button.
4. Set the damping with the ▲ and ▼ buttons.
5. To set the damping in steps of 0.10 s, press and hold down the buttons.
6. Use the ► button to confirm.

9.1.5 Application [05]

9.1.5.1 Set application

You use the "Application" parameter to adjust the device for the following measuring tasks.

- Pressure measurement
- Level measurement
- Volume flow measurement
- Mass flow measurement
- Volume measurement
- Customized characteristic curve (only available via remote operation). (Page 134)

Procedure via the local operation

1. Navigate to the parameter view.
Navigating in the views (Page 75)
2. Select the "Application" parameter [05].
3. Select the desired characteristic curve.
Characteristic curves (Page 108)
 - The device uses a linear characteristic curve for pressure and level measurements.
 - For volume and mass flow measurements, the device uses adjustable square root functions.
 - For volume measurement, the device uses the tank characteristic curves for various vessel geometries.
 - In the "Customized characteristic curve" application, enter the breakpoints of the characteristic curve using remote operation (e.g. SIMATIC PDM).

9.1.5.2 Operating principle

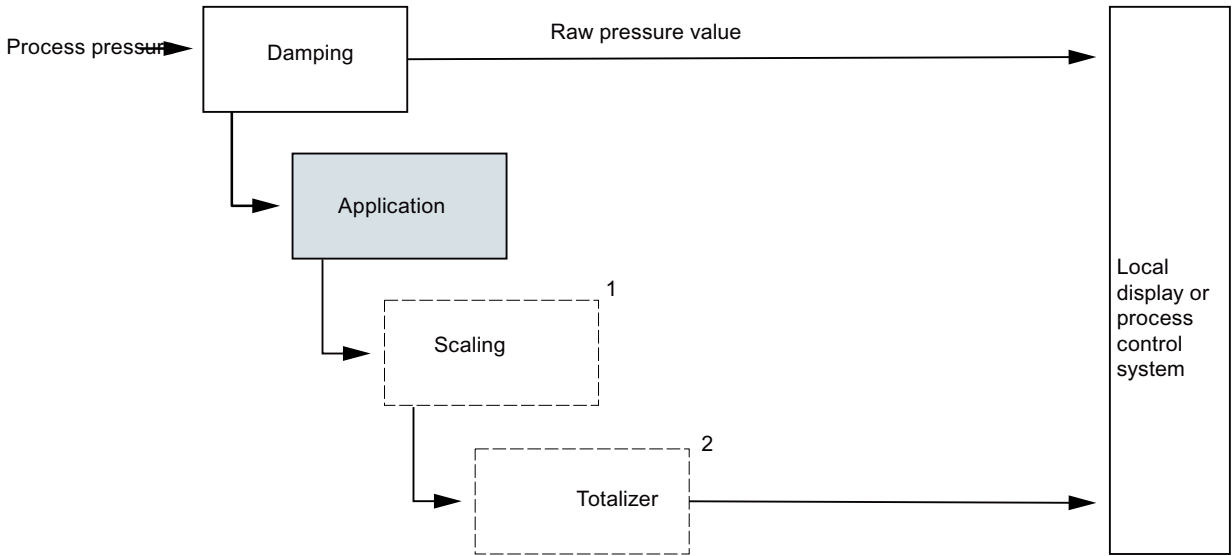

- 1 Is used for the measurement of the process values calculated from the measured pressure value (e.g. level). Assigns the initial value and the final value of the input signal to the respective values of the output signal.
- 2 Supplementary function for volume flow and mass flow measurements.
Totalizer (Page 131)

9.1.5.3 Level measurement

To set the application of the device for the level measurement, select the "level" characteristic curve using the "Application" parameter (LEVEL).

For a level measurement, the device calculates the level height and the hydrostatic pressure. The geometry of the vessel is not included in the calculation.

- The device uses a linear characteristic curve:

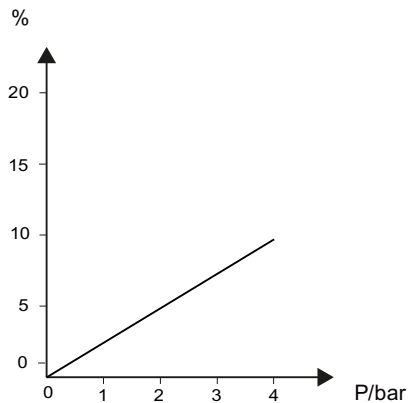

Example

For the level measurement, you set the following values, for example:

Damping value:	2.0 s
Lower range value:	0.0 bar
Upper range value:	5.0 bar
Application:	Level (LEVEL)
Unit:	m
Lower scaling point:	0.0 m
Upper scaling point:	49 m

9.1.5.4 Volume and mass flow measurements

The following characteristic curves are available for volume and mass flow measurements:

- Hold at 0, square root (VSOFF, for volume or MSOFF, for mass flow)**
 The output value remains 0 until the application point (**Low flow cut-off** (Page 117)). Starting from the application point, scaling occurs according to the square root:

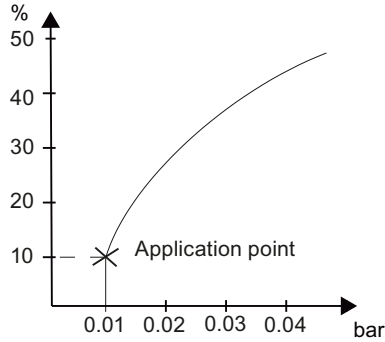

Y Flow rate
 Setting range for the application point: 0 ... 100%
 X Set measuring span

- Linear, square root (VSLN, for volume or MSLN, for mass flow)**
 The output value has a linear relationship with the differential pressure up to the application point (Page 108). Starting from the application point, scaling occurs according to the square root:

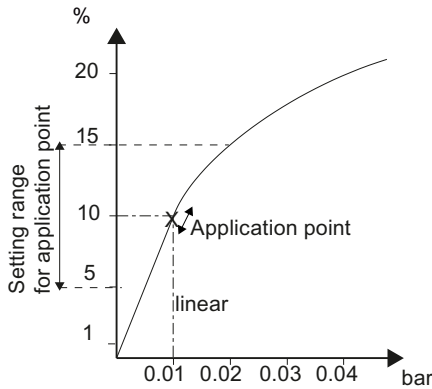

Y Flow rate
 X Set measuring span

- 2 step linear, square root (VSLN2, for volume or MSLN2, for mass flow)**
 The output value runs proportional to the flow, two-step linear up to the application point (Page 108).
 The square root SLIN2 has a permanently defined application point of 10%. The range up to this point contains two linear characteristic curve sections. The first section ranges from the zero point to 0.6% of the output value and 0.6% of the pressure value. The second section runs at a steeper slope up to the application point at 10% of the output value and 1% of the pressure value.

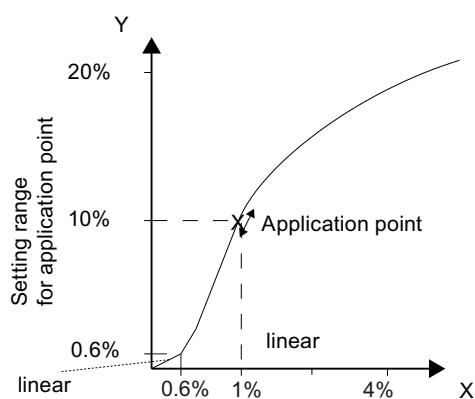

Y Flow rate
X Set measuring span

Example: Volume flow (linear)

For the volume flow measurement, you set the following values, for example:

Damping value:	2.0 s
Lower range value:	0.0 mbar
Upper range value:	0.6 bar
Application:	Linear, square root (VSLN)
Unit:	m ³ /h
Lower scaling point:	0.0 m ³ /h
Upper scaling point:	300 m ³ /h

Example: Mass flow (linear)

For the mass flow measurement, you set the following values, for example:

Damping value:	1 s
Lower range value:	0.0 mbar
Upper range value:	600 mbar
Application:	Linear, square root (MSLN)
Unit:	t/h
Lower scaling point:	0.0 t/h
Upper scaling point:	300 m ³ /s

9.1.5.5 Volume measurement

For the volume measurement, the device uses tank characteristic curves for various vessel shapes.

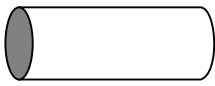
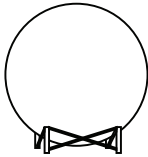
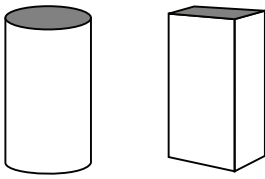
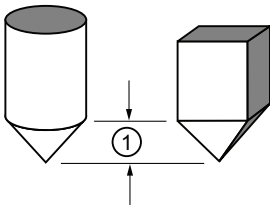
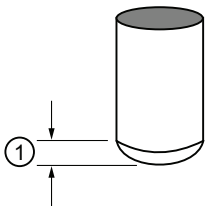
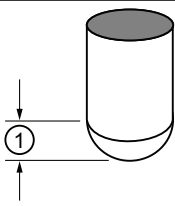
Display	Vessel	Description
CYLIN		Cylinder vessel
SPHER		Sphere vessel
LINR		Linear vessel
CONIC		Conical bottom vessel ①:Vessel dimension A
PARAB		Parabolic bottom vessel ①:Vessel dimension A
HALF		Half sphere bottom vessel ①:Vessel dimension A

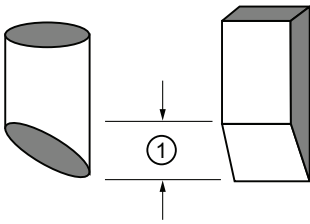
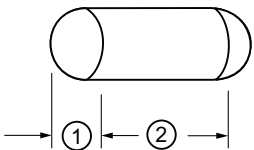
Display	Vessel	Description
FLAT		Flat sloped bottom vessel ①: Vessel dimension A
PARAE		Parabolic ends vessel ①: Vessel dimension A ②: Vessel dimension L

Example

For the volume measurement, you set the following values, for example:

Damping value: 2.0 s
 Lower range value: 0.0 mbar
 Upper range value: 500.0 mbar
 Application: Cylinder vessel (CYLIN)
 Unit: m^3
 Lower scaling point: 0.0 m^3
 Upper scaling point: 10.0 m^3

9.1.5.6 Characteristic curves

Setting range:	Application	Characteristic curve		
	Pressure	PRESS	Linear, proportional to pressure	
	Level	LEVEL	Linear, proportional to level	
	Volume flow	VSLN	Linear, square root Proportional to flow rate, linear up to the application point (Page 108)	
		VSOFF	Hold at 0, square root Proportional to flow rate, deactivated up to the suppression of the residual flow (Page 117)	
		VSLN2	Two-step linear - square root Proportional to flow, two-step linear up to the application point	
	Volume	CYLIN	Cylinder vessel	
		SPHER	Sphere vessel	
		VLIN	Linear vessel	
		CONIC	Conical bottom vessel	
		PARAB	Parabolic bottom vessel	
		HALF	Half sphere bottom vessel	
		FLAT	Flat sloped bottom vessel	
		PARAE	Parabolic ends vessel	
	Mass flow	MSLN	Linear, square root Proportional to flow rate, linear up to the application point (Page 108)	
		MSOFF	Hold at 0, square root Proportional to flow rate, deactivated up to the suppression of the residual flow (Page 117)	
		MSLN2	2 step linear, square root Proportional to flow, two-step linear up to the application point	
	Customized characteristic curve	CUSTM	Custom	
	Factory setting:	PRESS, or as specified in order		

9.1.6 Application point [06]

Sets the application point from which scaling occurs according to the square root. Before the application point, the scaling occurs in a linear relationship with the differential pressure.

This parameter is only visible when you have selected the characteristic curve "Linear, square root" (VSLIN or MSLIN) using the "Application" parameter.

Setting range:	5 to 15%
Factory setting:	10%

See also

Low flow cut-off [20] (Page 117)

9.1.7 Zero point adjustment [07]

Introduction

A series of factors, such as installation, static pressure, temperature or long-term stability, can cause zero-point errors.

For special applications (e.g. level measurement for a closed vessel), you have the option of shifting the zero point to a desired pressure value using the "Zero point adjustment" parameter.

You proceed differently depending on the device version.

9.1.7.1 Adjusting zero point (gauge pressure)

Requirement

The pressure measurement is stable.

Procedure

1. Vent the pressure connection of the device.
2. Navigate to the parameter view.
Navigating in the views (Page 75)
3. Select the "Zero point adjustment" parameter [07].
4. Press the ► button.
The value "0" appears on the display and the "EDIT" symbol flashes.
5. Set the zero point to 0 or to the desired value.
6. Confirm the value by pressing the ► button.
7. Change to the measurement view with the ◀ button.

Note

Depending on the damping setting, a settling time elapses until the pressure measurement 0 appears in the measurement view.

- For this reason, vent the pressure connection of the device up to the end of the operation.
-

Result

- The device displays the pressure measurement 0 in the set unit.
- The effective measuring range is reduced by the amount of the upstream pressure.
Example: With an upstream pressure of 100 mbar, the effective measuring range of a 1-bar pressure transmitter is reduced to a point between 0 and 0.9 bar.

9.1.7.2 Adjusting the zero point (differential pressure)

Requirement

The pressure measurement is stable.

Procedure

1. Make sure there is identical pressure in the two process connections.
2. Navigate to the parameter view.
Navigating in the views (Page 75)
3. In the parameter view, select the "Zero point adjustment" parameter [07].
4. Press the ► button.
5. Set the zero point to 0 or to the desired value.
6. Confirm the value by pressing the ► button.
7. Change to the measurement view with the ◀ button.

Note

Depending on the damping setting, a settling time elapses until the pressure measurement 0 is displayed.

- Make sure there is identical pressure in the two process connections until the end of the operation.
-

Result

- The device displays pressure measurement 0 in the set unit.
- The effective measuring range is reduced by the amount of the upstream pressure.
Example: At a pre-load pressure of 25 mbar, the upper measuring range limit of a 250 mbar pressure transmitter is reduced to 225 mbar.

9.1.7.3 Adjusting zero point (absolute pressure)**Requirement**

You have created a reference pressure that is within the measurement limits.

Procedure

1. Navigate to the parameter view.
Navigating in the views (Page 75)
2. Select the "Zero point adjustment" parameter [07].
3. Press the ► button.
The value "0" appears on the display and the "EDIT" symbol flashes.
4. Enter the known reference pressure using the ▲ or ▼ buttons.
5. Confirm the value by pressing the ► button.
6. Change to the measurement view with the ◀ button.

Result

The device displays pressure measurement 0 in the set unit.

Depending on the set damping, the settling time is extended until the pressure measurement 0 is displayed.

Note

For devices for absolute pressure, the lower range value is at vacuum (0 bar a).

The zero point adjustment for devices for absolute pressure that do not measure absolute pressure (0 bar a) leads to incorrect settings.

9.1.8 Units [16]

Introduction

Depending on the application of the device that you have selected using the "Application" parameter, you have the option of selecting a unit:

- Level
- Volume
- Volume flow
- Mass flow

The selected unit is displayed in the measurement view.

Use the remote operation to set the associated unit for the "Customized characteristic curve" application.

Note

Changing the units during cyclic operation

In PROFIBUS PA, the measured value without unit is transferred immediately to the control system during cyclic operation.

If you change the unit on the display or via the parameter assignment tool during cyclic operation, the converted measured value without unit is transferred immediately.

- Example: When you change the unit on the display from 1 bar to 1 000 mbar, 1 000 bar is displayed in the control system instead of 1 000 mbar.
-

9.1.8.1 Level units [16]

Selects the unit for the "Level" measurement.

This parameter is only visible when you have selected the "Level" characteristic curve using the "Application" parameter.

Setting range:	m
	cm
	mm
	in
	ft
Factory setting:	m

9.1.8.2 Volume units [16]

Selects the unit for the "Volume" measurement.

This parameter is only visible when you have selected a volume characteristic curve using the "Application" parameter.

Certain units are displayed differently on the display and over remote operation. (Page 98)

Setting range:	Display (header line)	Display (enumeration)	Remote operation
	Gal	Ga	gal
	Gal [UK]	lGa	gal (UK)
	l	l	l
	hl	hl	hl
	m ³	m ³	m ³
	in ³	in ³	in ³
	Ft ³	Ft ³	ft ³
	bu	bu	bu
	Yd ³	Yd ³	yd ³
	bbl	bbl	bbl
	bbl [US]	Ubb	bbl (US)
	Nl	Nl	Nl
	Nm ³	Nm ³	Nm ³
	SCF	SCF	SCF
Factory setting:	m ³		

9.1.8.3 Volume flow units [16]

Selects the unit for the "Volume flow" measurement.

This parameter is only visible when you have selected a volume flow characteristic curve using the "Application" parameter.

Certain units are displayed differently on the display and over remote operation. (Page 98)

Setting range:	Display (header line)	Display (enumeration)	Remote operation
	m3/sec	m3/S	m ³ /s
	m3/min	m3/m	m ³ /min
	m3/h	m3/h	m ³ /h
	m3/d	m3/d	m ³ /d
	l/Sec	l/S	l/s
	l/min	l/m	l/min
	l/h	l/h	l/h
	MI/d	MI/d	MI/d
	FT3/Sec	Ft3/S	ft ³ /s
	Ft3/min	Ft3/m	ft ³ /min
	Ft3/h	Ft3/h	ft ³ /h
	Ft3/d	Ft3/d	ft ³ /d
	SCF/min	SCF/m	SCF/min
	SCF/h	SCF/h	SCF/h
	NI/h	NI/h	NI/h
	Nm3/h	Nm3/h	Nm ³ /h
	Gal[UK]/Sec	IGa/S	gal (UK)/s
	Gal[UK]/min	IGa/m	gal (UK)/min
	Gal [UK]/h	IGal/h	gal (UK)/h
	Gal[UK]/d	IGa/d	gal (UK)/d
	Gal/Sec	Ga/S	gal/s
	Gal/min	Ga/m	gal/min
	Gal/h	Ga/h	gal/h
	Gal/d	Ga/d	gal/d
	Mgal/d	MGI/d	Mgal/d
	bbl/d	bbl/d	bbl/d
	bbl/h	bbl/h	bbl/h
	bbl/min	bbl/m	bbl/min
	bbl/Sec	bbl/S	bbl/s
Factory setting:	m ³ /s		

9.1.8.4 Mass flow units [16]

Selects the unit for the mass flow measurement.

This parameter is only visible when you have selected a mass flow characteristic curve using the "Application" parameter.

Certain units are displayed differently on the display and over remote operation. (Page 98)

Setting range:	Display (header line)	Display (enumeration)	Remote operation
	KG/Sec	KG/S	kg/s
	Gr/Sec	G/S	g/s
	Gr/min	G/m	g/min
	Gr/h	G/h	g/h
	KG/min	KG/m	kg/min
	KG/h	KG/h	kg/h
	KG/d	KG/d	kg/d
	t/min	t/m	t/min
	t/h	t/h	t/h
	t/d	t/d	t/d
	lb/Sec	lb/S	lb/s
	lb/min	lb/m	lb/min
	lb/h	lb/h	lb/h
	lb/d	lb/d	lb/d
	ton/min	sto/m	ton/min
	ton/h	sto/h	ton/h
	ton/d	sto/d	ton/d
	ton(UK)/h	Lto/h	ton (UK)/h
	ton(UK)/d	Lto/d	ton (UK)/d
Factory setting:	kg/s		

9.1.9 Temperature units [17]

Selects the temperature unit for the "Sensor temperature" and "Electronics temperature" measurements that are displayed in the measurement view.

Setting range:	K
	°C
	°F
	°R
Factory setting:	°C

9.1.10 Lower output scaling point [18]

Sets the lower range value for the output scaling.

Depending on the application of the device, you set the lower scaling point as follows:

9.1 Parameter assignment over device with display

Level

Setting range:	Freely selectable numeric value
Factory setting:	0 m

Volume

Setting range:	Freely selectable numeric value
Factory setting:	0 m ³

Volume flow

Setting range:	Freely selectable numeric value
Factory setting:	0 m ³ /s
Setting range:	Freely selectable numeric value
Factory setting:	0

Mass flow

Setting range:	Freely selectable numeric value
Factory setting:	0 kg/s
Setting range:	Freely selectable numeric value
Factory setting:	0

Custom units

Setting range:	Freely selectable numeric value
Factory setting:	USER DEFINED (custom), or as specified in order

The various applications are described in the section Application [05] (Page 101).

9.1.11 Upper output scaling point [19]

Sets the upper range value for the output scaling.

Depending on the application of the device, you set the upper scaling point as follows:

Level

Setting range:	Freely selectable numeric value
Factory setting:	100 m

Volume

Setting range:	Freely selectable numeric value
Factory setting:	1000 m ³

Volume flow

Setting range:	Freely selectable numeric value
Factory setting:	1000 m ³ /s

Mass flow

Setting range:	Freely selectable numeric value
Factory setting:	1000 kg/s

Custom units

Setting range:	Freely selectable numeric value
Factory setting:	USER DEFINED (custom), or as specified in order

9.1.12 Low flow cut-off [20]

Sets the flow value for the low flow cut-off. The flow value is suppressed up to certain percentage of the output value.

The parameter is visible when you have selected the "Hold at 0, square root" (VSOFF or MSOFF) characteristic curve using the "Application" parameter.

Setting range:	0% - 100%
Factory setting:	10%

9.1.13 Vessel dimension A [21]

Sets the height of the vessel bottom for the following vessel shapes:

- Conical bottom vessel (CONIC)
- Parabolic bottom vessel (PARAB)
- Half sphere bottom vessel (HALF)
- Flat sloped bottom vessel (FLAT)

For a lying parabolic ends vessel (PARAE) the set value corresponds to the height of the end piece.

You can find a figure with the different vessel shapes under "Volume measurement (Page 106)".

Setting range:	0 to 100%
Factory setting:	0%

For the calculated volume to correspond to the actual vessel volume, set the parameters Vessel dimension A and Vessel dimension L as follows:

- Vessel dimension L + 2 • Vessel dimension A = 100%.
Example: Vessel dimension L is 80% and vessel dimension A is 10%.

9.1 Parameter assignment over device with display

 WARNING
Overfilling the vessel To avoid overfilling the vessel, set a limit alarm: The limit must be below the maximum measuring range ① and have a sufficient minimum distance to the top edge of the vessel.

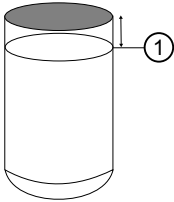

9.1.14 Vessel dimension L [22]

Sets the length of the bottom vessel for a lying parabolic ends vessel (PARAE).

You can find a figure with the different vessel shapes under "Volume measurement (Page 106)".

Setting range:	0 to 100%
Factory setting:	0%

For the calculated volume to correspond to the actual vessel volume, set the parameters Vessel dimension A and Vessel dimension L as follows:

- $\text{Vessel dimension L} + 2 \cdot \text{Vessel dimension A} = 100\%$.
 Example: Vessel dimension L is 80% and vessel dimension A is 10%.

9.1.15 Button lock [23]

Enables the button lock. You can continue to operate the device using remote operation.

Setting range:	ON	Button lock enabled
	OFF	Button lock disabled
Factory setting:	OFF	

9.1.15.1 Enabling button lock

Procedure

1. Navigate into the parameter view.
Navigating in the views (Page 75)
2. In the parameter view, select the "Button lock" parameter.
3. Press the ► button.
The "EDIT" symbol flashes.
4. Select ON with the ▲ or ▼ button.



5. Use the ► button to confirm.

Result

- The display automatically returns to the measurement view.
- The display automatically changes between the measured values every 12 seconds.
- The symbol for button lock "LL" and the measured value ID are displayed alternately.

Note

For a device without display, you activate the button lock using remote operation.

9.1.15.2 Disabling button lock

Procedure

To disable the button lock, press and hold the ► button for 5 seconds.

Result

- The symbol for Button lock "LL" is hidden.
- You can operate the device using the buttons.

Note

For a device without display, you deactivate the button lock using remote operation.

9.1.16 Change user PIN [24]

Used to change the User PIN.

Setting range:	1 to 65535
Factory setting:	2457

Requirement

The "User PIN (Page 123)" parameter is enabled.

Procedure

1. Navigate to the parameter view.
Navigating in the views (Page 75)
2. Select the parameter "Change user PIN".



3. Press the ► button.
4. Enter the old user PIN.
5. Enter the new user PIN with a value between 1 and 65535.
Changing parameter values (Page 80)



6. Use the ► button to confirm.
7. Repeat the new user PIN and use the ► button to confirm.



Result

- If both user PINs match, the "COMPL" message appears.
The user PIN has been successfully changed.
- If the two user PINs do not match, the "FAILD" message appears.
Then repeat the described procedure.

9.1.17 Recovery ID [25]

Shows the recovery ID.

If you have forgotten your user PIN, you will need a recovery ID. The "Recovery ID" parameter shows a number that is necessary for restoring the user PIN.



Figure 9-1 Example

9.1.17.1 Display Recovery ID

Requirements

The "User PIN" parameter is enabled.

Procedure

1. Navigate to the parameter view.
Navigating in the views (Page 75)
2. Select the "Recovery ID" parameter.
This Recovery ID is displayed.

Result

Please contact the Technical Support (Page 234) with the displayed recovery ID and the serial number of your device.

You can find the serial number of the device on the nameplate or via remote operation.

Siemens Technical Support will give you a PUK (PIN Unlock Key) that you use to reset the user PIN to the factory setting 2457.

9.1.18 PIN recovery [26]

Used to reset the user PIN to the factory setting.

The user PIN is factory set to 2457 in the device.

9.1.18.1 Recovering the user PIN

Requirement

- You have received the PUK from Technical Support. (Page 121)
- The "User PIN (Page 123)" parameter is enabled.

Procedure

1. In the parameter view, select the "PIN recovery" parameter.



2. Press the ► button.
The cursor and the "EDIT" symbol flash.
3. Enter the digits of the PUK:
 - Use the ▲ or ▼ button to change.
 - Use the ► button to confirm.
 - Use the ◀ button to delete.

The complete PUK is shown on the top line of the display.



4. When the PUK is complete, use the ► button to confirm.

Result

- If you have entered the correct PUK, the message "NEW PIN - 2457" appears.
The user PIN has been reset to the factory setting 2457.
- If the PUK was not correctly entered, the message "FAILED" appears.
Then repeat the described procedure.

9.1.19 User PIN [27]

Used to enable or disable the user PIN.

Setting range:	ON	Enable user PIN
	OFF	Disable user PIN
Factory setting:	User PIN disabled	

When the user PIN is enabled, the measured values and parameters are read-only.

- To change the parameters and use the device functions, the user PIN must be input.

The user PIN 2457 is factory preset in the device.

Note

Write protection is automatically enabled 10 minutes after the last button operation.

- Enter the user PIN.
-

9.1.19.1 Enable user PIN

Requirement

The User PIN is disabled.

Procedure

1. Navigate to the parameter view.
Navigating in the views (Page 75)
2. Select the parameter "User PIN".
3. Use the ► button to confirm.
The message "USER PIN ON" (User PIN enabled) appears for 2 seconds.

Result

The User PIN is activated after about 10 minutes or after a device restart.



9.1.19.2 Disable user PIN

Requirement

The user PIN is enabled.

Procedure

1. Navigate to the parameter view.
Navigating in the views (Page 75)
2. Select the parameter "User PIN".
3. Use the ► button to confirm.
4. Select YES with the ▲ or ▼ button.



5. Use the ► button to confirm.
The message "USER PIN OFF" appears for 2 seconds.

Result

The User PIN is disabled.



9.1.20 Display test [30]

Used to check that numbers, texts and symbols appear correctly on the display.



- To start the Display test, press the ► button and select "START".
When the Display test is complete, the message "COMPL" appears.
- To cancel the Display test, press the ◀ button.

9.1.21 Start view [32]

Selects the value that is displayed as the first measured value in the measurement view.

For the selection to take effect, change from the parameter view to the measurement view or restart the device.

Setting range:	Edit view	Measurement view
	PRESS	Pressure (P1)
	STEMP	Sensor temperature (P2)
	ETEMP	Electronics temperature (P3)
	LEVEL	Level (P4)
	VOL	Volume (P5)
	VFLOW	Volume flow (P6)
	MFLOW	Mass flow (P7)
	USER	Customized characteristic curve (P8)
Factory setting:	PRESS	

Note

To have the process value for "Level", "Volume", "Mass flow", "Volume flow" or "Customized characteristic curve" shown as the "Start view", first set the associated characteristic curve using the "Application" parameter.

See also

Characteristic curves (Page 108)

9.1.22 Pressure reference [33]

Used to adapt the display of the pressure unit to your application.

Setting range:	NONE	Not specified
	GAUGE	Gauge pressure
	ABS	Absolute pressure
Factory setting:	NONE	

See also

Pressure units [01] (Page 97)

9.1.23 Reset [35]

9.1.23.1 Reset parameters

Used to reset the following settings:

Setting range:	Restore ordered configuration	CUST
	Reset to sensor calibration	SENSR
	Factory reset	FACT

9.1.23.2 Reset to sensor calibration

Resets the zero point and sensor calibration to the factory setting.

9.1.23.3 Restore ordered configuration

With this function you return your device to its delivery state.

- The ordered configuration of the following parameters is restored:
 - Pressure units
 - Quick start
 - Pressure reference
 - Long tag (TAG)
 - Location designation
 - Measuring point description
 - Input and output scaling
 - Damping value
 - Application and related values (e.g.: vessel shapes and application points)
 - Custom units
- The parameters that you have not configured via the order are reset to the factory settings.

9.1.23.4 Restore factory settings

With this function you return your device to its factory setting.

The following settings are reset to the factory setting among other things:

- Sensor calibration
- The defaults that you have configured in your order are overwritten with this function. These defaults can then deviate from the ordered configuration. To restore the ordered configuration, use the "Restore ordered configuration (Page 126)" parameter.

9.1.24 FW version [37]

Displays the firmware version of the device.

You can also find the firmware version on the device nameplate or via remote operation.

9.1.25 Configuration change counter [38]

Displays number of times device configuration or calibration changed, locally or via engineering system.

9.1.26 Slave address [40]

Sets the station address of the device on the fieldbus.

The parameter can only be set when the device is **not** in cyclic operation.

Setting range:	0 to 126
Factory setting:	126 or as specified in order

9.1.27 GSD SELECT [41]

Selects the device master data (GSD) file that determines the configuration and functionality of the device in the control system.

The GSD file contains a device or profile-specific identification number. You will find the identification number supported by the device on the nameplate.

The parameter can only be set when the device is **not** in cyclic operation.

Note

When you have selected a GSD file that is not supported by the device, the device does not start cyclic operation.

Setting range:	Display shows	Meaning
	Auto	<ul style="list-style-type: none"> The device automatically applies the configuration and functionality configured in the control system. The configuration must be one of those listed below. Select this option, for example, to replace SITRANS P DSIII with SITRANS P420.
	b310	Profile V4 - Pressure (pa15B310.gsd)
	81dc	Manufacturer-specific GSD or SITRANS P320 PA (siem81DC.gsd)

9.1 Parameter assignment over device with display

	81dd	Manufacturer-specific GSD or SITRANS P420 (siem81DD.gsd)
	80A6	SITRANS P DSIII/P410 PA (siem80A6.gsd)
	8121	SITRANS P300 PA (siem8121.gsd)
	b311	Profile V4 - Hydrostatic level (pa15B311.gsd)
	b312	Profile V4 - Differential pressure-type flow (pa15B312.gsd)
	9700	<ul style="list-style-type: none"> Profile V3 - 1AI (pa139700.gsd) Profile V3 - 1AI (pa039700.gsd) PA Profile 3 Specific GSD (1 Analog Input)
	9740	<ul style="list-style-type: none"> Profile V3 - 1AI, TOT (pa139740.gsd) PA Profile 3 Specific GSD (1 Analog Input, 1 Totalizer)
Factory setting:	Auto	

9.1.27.1 Startup parameters

With the GSD file as of Profile 4.0, the device offers the option to define specific parameters (e.g. units) using the so-called startup parameters for PROFIBUS. The startup parameters are transferred to the devices on each restart.

Procedure in SIMATIC STEP 7 hardware configuration

1. Click on your device.
2. Select the "Object properties" command in the shortcut menu.
3. Go to the "Parameter assignment > Device-specific parameters" tab.
4. Set the parameter "Startup parameters" to "All settings are used".

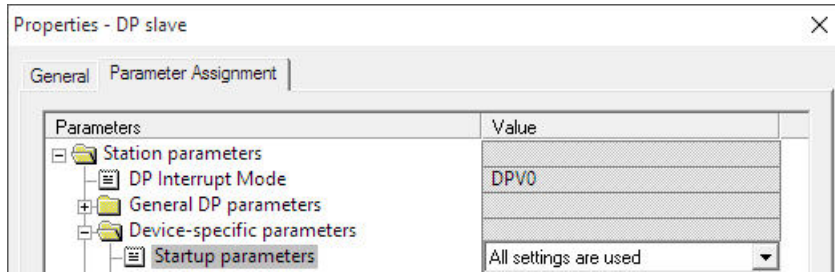

5. Define the parameter values. (The parameter values are not shown in the previous figure.)
6. Confirm with "OK".

Result

- After a system startup or device restart, the parameters are transferred to the device even if the device is write-protected.
- If you set the parameter "Startup parameters" to "Set via ext. eng. tool" ("Set via external engineering tool"), the set parameters are not applied by the device after a restart: The parameters set on the display or via the parameter assignment tool remain the same.

9.1.28 Active GSD (General Station Description) [42]

Shows the GSD file that the device uses in the control system.

Note

When you have selected a GSD file that is not supported by the device, the device does not start cyclic operation.

Setting range:	Indication on the display	Meaning
	Auto	Automatic adaption
	NoCyc	Cyclic operation not started
	b310	Profile V4 - Pressure (pa15B310.gsd)
	81dc	SITRANS P320 PA (siem81DC.gsd)
	81dd	SITRANS P420 PA (siem81DD.gsd)
	80A6	SITRANS P DSIII/P410 PA (siem80A6.gsd)
	8121	SITRANS P300 PA (siem8121.gsd)
	b311	Profile V4 - Hydrostatic level (pa15B311.gsd)
	b312	Profile V4 - Differential pressure-type flow (pa15B312.gsd)
	9700	<ul style="list-style-type: none"> • Profile V3 - 1AI (pa139700.gsd) • Profile V3 - 1AI (pa039700.gsd) • PA Profile 3 Specific GSD (1 Analog Input)
	9740	<ul style="list-style-type: none"> • Profile V3 - 1AI,TOT (pa139740.gsd) • PA Profile 3 Specific GSD (1 Analog Input, 1 Totalizer)
Factory setting:	<ul style="list-style-type: none"> • SITRANS P420 PA (siem81DD.gsd) or • SITRANS P320 PA (siem81DC.gsd) 	

9.2 Parameter assignment over remote operation

9.2.1 Introduction

This section describes the most important parameters and functions that are available additionally over remote operation:

- "Quick Start" wizard
- Identification (TAG)
- Totalizer
- Simulation
- Customized characteristic curve
- Sensor calibration
- Diagnostics functions
 - Limit monitoring and event counter (not available on SITRANS P320)
 - Trend log (not available on SITRANS P320)
 - Operating hours counter

9.2.2 Quick start

You use the "Quick start" wizard to configure your device in five steps for the required application:

- Step 1: Identification
- Step 2: Application
- Step 3: Scaling

Note that you set the displayed pressure unit with the "Pressure unit" parameter and not with the wizard.
Set the unit of the selected application (e.g. volume, mass flow) also via the parameter group "Settings".
- Step 4: Totalizer
- Step 5: Summary

The summary provides an overview of the "old" and "new" parameters.
To store the parameters in SIMATIC PDM and transfer them to the device, click the "Apply" button.

9.2.3 Identification

Define the data that you need to identify your device under the "Identification" parameter group. A distinction is made between data you can set yourself and values that are preset in the factory.

The default values are write-protected and cannot be changed. The corresponding allocation is set out in the following example:

Parameter	Adjustable	Preset	Factory setting
Long tag	Yes	-	-
Description	Yes	-	-
Location designation	Yes	-	-
Installation date	Yes	-	-
Device			
Manufacturer	-	Yes	Siemens
Product name	-	Yes	SITRANS P420
Article number	-	Yes	e.g. 7MF0440-1GL01-5AF2-Z
Order option 1/Order option 2	-	Yes	e.g. A01+C11+C12+C14+C20+E00+H01+Y01+Y15+Y21
Hardware version	-	Yes	In accordance with the measuring cell selection/device manufacture
Firmware version	-	Yes	In accordance with the measuring cell selection/device manufacture
EDD version	-	Yes	
Serial number	-	Yes	In accordance with the measuring cell selection/device manufacture
Sensor type	-	Yes	In accordance with the measuring cell selection/device manufacture
Maximum measuring span	-	Yes	In accordance with the measuring cell selection/device manufacture

9.2.4 Totalizer

The device has a totalizer that can be used to totalize the mass flow or volume flow.

You can configure the totalizer for measuring the net flow, the low pressure or the high pressure flow.

In case of a device fault, the following options are available for fail-safe behavior of the totalizer:

- "Hold": Totalizer holds the last value before the error occurred.
- "Continue counting": Totalizer continues counting the current measured value.
- "Count latest good value": Totalizer continues counting starting with the last input value (for example mass flow) before the error occurred.

Startup parameters

In the SIMATIC STEP 7 hardware configuration, for example, you can set the startup parameters for the totalizer:

1. Click on your device.
2. Click on the module of the totalizer in the lower area of the station window.

9.2 Parameter assignment over remote operation

3. Select the "Object properties" command in the shortcut menu.
4. Follow the further steps described in the section "Startup parameters".
Startup parameters (Page 128)

9.2.5 Simulation

You can use the device to simulate the following via remote operation (e.g. SIMATIC PDM):

- Input and output values
 - Constant pressure values
 - Ramp function
- Diagnostics

Note

The simulated pressure value has a direct effect on the configured process value (e.g. volume or flow rate).

Simulation via FOUNDATION Fieldbus

Activation of the simulations requires the jumper to be inserted.

Insert jumper (Page 61)

9.2.5.1 Simulate constant pressure values

Procedure

To simulate a constant pressure value via remote operation (e.g. SIMATIC PDM), follow these steps:

1. For the "Simulation mode" parameter, set the "Enabled" option to simulate a constant pressure value.
2. Select the pressure value ("Process value") to be simulated from the drop-down list under the "Simulation selection" parameter.
3. For the "Simulation value" parameter, set the desired constant pressure value for the simulation.
4. Set status to be simulated for the "PV status" parameter.
5. Click "Transfer" to start the simulation.
6. For the "Simulation mode" parameter, set the "Disabled" option to stop the simulation.

Result

The measured value is replaced by a constant simulation value. The simulation influences the output signal.

The diagnostic ID "Cb" is displayed on the device.

9.2.5.2 Simulate ramp function

To simulate a ramp function via remote operation (e.g. SIMATIC PDM), follow these steps:

1. For the "Simulation mode" parameter, set the "Ramp" option to simulate a changing pressure value.
2. Select the pressure value ("Process value") to be simulated from the drop-down list under the "Simulation selection" parameter.
3. For the "Simulation value" parameter, set the desired start value for the simulation.
4. Set status to be simulated for the "PV status" parameter.
5. Set the "Ramp end" parameter .
6. Set the "Ramp steps" parameter to define the number of steps in the ramp simulation.
7. Set the "Ramp duration" parameter to define the time interval (in seconds) for each step in the simulation.
8. Click "Transfer" to start the simulation.
9. For the "Simulation mode" parameter, set the "Disabled" option to stop the simulation.

9.2.5.3 Simulate diagnostics

Procedure

To simulate diagnostics via remote operation (e.g. SIMATIC PDM), follow these steps:

1. Open the "Device" menu in SIMATIC PDM and select "Simulation > Diagnostics".
2. To put the device into simulation mode, press the "Enable" button in the "Simulation diagnostics" tab.
(Button switches between "Enable" and "Disable").
3. Select the diagnostics you want to simulate from the drop-down box of the "Diagnostics" field.
4. Select "Action" for each selected diagnostic action to be simulated: "On" or "Off".
5. To start the simulation, click on the "Apply and transfer" button.

The diagnostic status of the simulation selected for each diagnostic is displayed in additional tabs in the dialog box. The simulated diagnostics is indicated by a check mark in the check box.

End diagnostics simulation

You close the simulation in the "Diagnostics simulation" tab:

- To disable a specific diagnostic action, click "Off" (under the "Action" field).
- To end the diagnostics simulation, click on the "Disable" button.

 WARNING
When diagnostics simulation is enabled, diagnostic events of the real process are neither recorded nor evaluated.
With activated diagnostics simulation, the diagnostics ID and "SIMUL" are displayed on the device display.
Stop diagnostics simulation immediately after use:
<ul style="list-style-type: none">• Click "Disable" in the "Diagnostics simulation" tab before you close the "Diagnostics" dialog.• Alternatively, you can restart the device.

9.2.6 Customized characteristic curve

9.2.6.1 Introduction

For special applications, a customized characteristic curve is available.

This application is used, for example, for volume measurement in vessels with unusual shapes.

You specify the relationship between the input pressure and output value flow in accordance with your user-specific requirements.

You have up to 32 breakpoints available for this, which you enter using the engineering system and display graphically.

Example

For measurement with the customized characteristic curve, you set the following values, for example:

Damping value:	2.0 s
Lower range value:	0 bar
Upper range value:	10 bar
Application:	Custom (CUSTM)
Unit:	Cans
Lower scaling point:	0 cans
Upper scaling point:	250 cans
x values:	0%, 25%, 50%, 75%, 100%
y values:	0%, 25%, 50%, 75%, 100%

9.2.6.2 Custom unit parameter

Selects a custom unit.

The selected unit is displayed in the measurement view.

Setting range:	Up to 12 characters
Factory setting:	0 or as specified in order

This parameter is only visible when you have selected a custom characteristic curve using the "Application" parameter.

9.2.6.3 Set customized characteristic curve

Requirement

- You have set the "Customized characteristic curve" application.
- You have set a custom unit.
- You have set the lower scaling point and the upper scaling point.

Procedure

1. Select the "Customized characteristic curve" menu.
2. Read the data from the device.
3. Enter the desired number of breakpoints.
You can enter a minimum of two and up to 32 breakpoints.
4. Enter the x values and y values.

Note

The x values must increase monotonically. Otherwise, the x values are not accepted by the device.

The characteristic curve is displayed as diagram.

The x values are shown as pressure value or as percentage of the set pressure range.

The y values are displayed in the user-specific unit or as a percentage of the configured user-specific range.

5. Transfer the characteristic to the device.

Result

The output value now follows the set characteristic curve.

Values below the first breakpoint or above the last breakpoint are extrapolated.

9.2.7 Sensor calibration

You use the sensor calibration to set the characteristic curve of the device at two trim points. The results are then correct measured values at the sensor trim points.

The sensor trim points can be selected as any points within the nominal range.

Devices that are not turned down prior to delivery are trimmed at 0 bar and the high limit of the nominal range.

Devices that are turned down prior to delivery are trimmed at the low and high limits of the set measuring range.

Examples

- For a particular device that is not turned down (e.g. 63 bar), the typical measured value is 50 bar. To attain the highest possible accuracy for this value, set the upper sensor trim at 50 bar.
- A 63-bar pressure transmitter is turned down to 4 to 7 bar. You can attain the highest possible accuracy by selecting 4 bar for the low trim point and 7 bar for the high trim point.
- A 250-mbar absolute pressure transmitter shows 25 mbar at 20 mbar. A reference pressure of 20 mbar is available. To correct the zero point, perform a sensor trim at the lower trim point with 20 mbar.

Note

Use a test device whose accuracy is at least three times as high as the accuracy of the pressure transmitter.

Sensor calibration at the low calibration point

1. Use remote control (e.g. SIMATIC PDM) to select the menu command "Device > Sensor calibration".
2. Apply the pressure for the low calibration point at the device.
3. Apply the pressure value that you have created and assign the pressure value to the device. The device applies the set value.
The device carries out an offset correction of the characteristic curve.

Sensor calibration at the high calibration point

1. Use remote control (e.g. SIMATIC PDM) to select the menu command "Device > Sensor calibration".
2. Apply the pressure for the high calibration point at the device.
The high calibration point needs to be greater than the low calibration point.
3. Apply the pressure value that you have created and assign the pressure value to the device. The device applies the set value.
The device carries out an offset correction of the characteristic curve.
The low calibration point is not affected by this.

Result

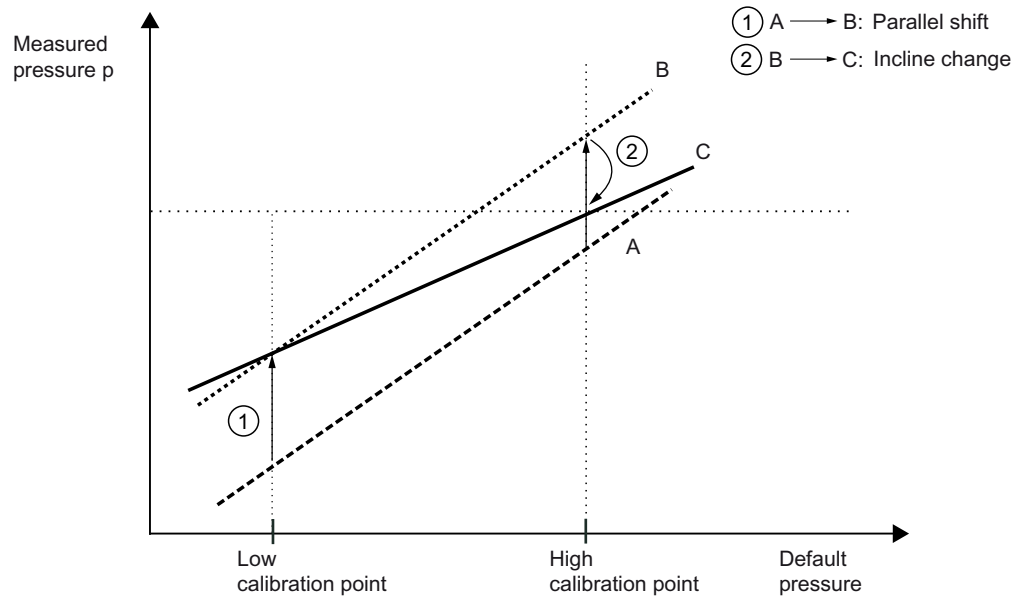

- A Original characteristic
- B Characteristics after sensor calibration at the low calibration point
- C Characteristics after sensor calibration at the high calibration point

9.2.8 Diagnostics functions

9.2.8.1 Limit monitoring and event counter

Introduction

With the limit monitoring and event counter function, the following options are available to you via remote operation (e.g. SIMATIC PDM):

- Monitoring process values
- Counting events based on configured limits
- Triggering, acknowledging and resetting process value alarms and warnings.

Configuring limit monitoring

Procedure

1. Select the menu command "Device > Limit monitoring and event counter".
The "Limit monitoring" tabs are displayed.
2. To trigger a process value alarm each time the value falls below or exceeds the limit, set the "Limit monitoring" text box to "Enabled".
3. Select the process value (e.g. sensor temperature) that you want to monitor from the "Monitored value" drop-down list.
Configure only one process value per tab.
4. In the "Upper limit", "Lower limit" and "Hysteresis" text boxes, enter the values that trigger an event.
If the process value rises above the upper limit (overrun) or falls below the lower limit (underrun), an event is counted based on the configured value for the hysteresis.
Hysteresis (Page 140)
5. If necessary, configure the event counter.
Configuring the event counter (Page 138)
6. Click on "Transfer".

Result

The process value alarm is displayed as a symbol for the status in the "Diagnostics > Device state" dialog of the engineering system and on the device screen.

It is not necessary to acknowledge the process value alarms.

If the monitored process value is again within the limit values, the process value alarm is reset.

Configuring the event counter

Requirement

You have configured the following values in limit monitoring:

- Upper limit
- Lower limit
- Hysteresis

Configuring limit monitoring (Page 138)

Procedure

1. In the "Limit" text box, enter the number of underrun and overrun events that must be reached in order to trigger the action for underrun and overrun respectively.
2. From the "Action" drop-down list, select whether process value alarms or warnings (maintenance demanded and maintenance required) are triggered.
 - If you set the action to "Disabled", no new process value alarms or warnings for the set limit values are triggered, although the counter remains in operation. All process value alarms and warnings that were triggered before the action was set to Disabled remain pending until the event counter is reset.
3. Click on "Transfer".

Result

The configured diagnostics are triggered after the specified number of limit violations has been reached (e.g. Maintenance required).

Process value alarms and warnings are displayed as symbols for the status in the "Diagnostics > Device state" dialog in the engineering system and on the device screen.

These process value alarms and warnings must be acknowledged.

Acknowledging process value alarms and warnings (Page 139)

Acknowledging process value alarms and warnings

Requirement

You have configured the event counter.

Configuring the event counter (Page 138)

Procedure

1. Select the menu command "Device > Limit monitoring and event counter".
2. Click "Reset and acknowledge".

Result

Process value alarms and warnings are acknowledged and deleted.

The event counter is reset.

Hysteresis

The hysteresis works as follows:

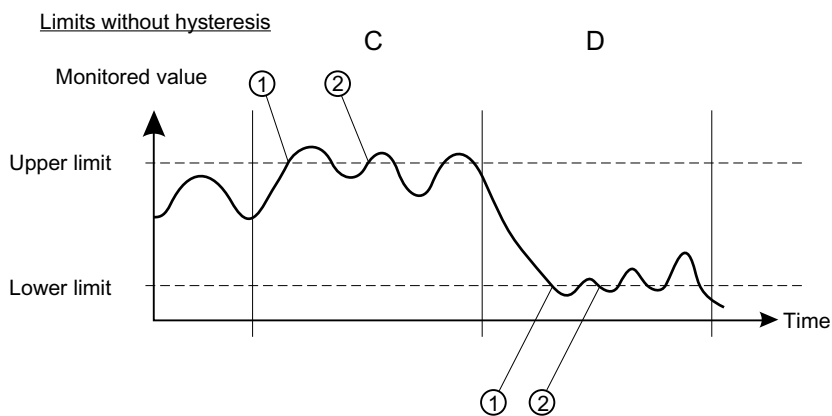
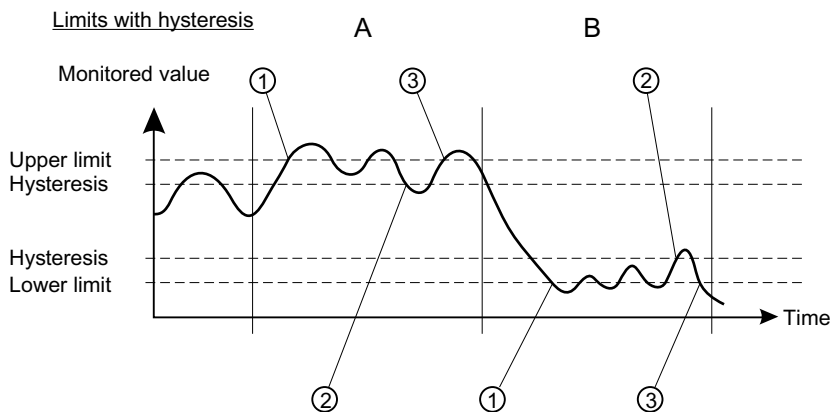

Limits with hysteresis

If you enter a non-zero value in the "Hysteresis" text box, the hysteresis is disabled.

Upper limit with hysteresis (A)

An overrun event is counted when the process value rises above the upper limit ①.

The next overrun event is counted when the process value falls below the lower limit minus the entered hysteresis ② and then rises above the upper limit ③.

Two events are counted in the displayed time period within 'A'.

Lower limit with hysteresis (B)

An underrun event is counted when the process value falls below the lower limit ①.

The next underrun event is counted when the process value first rises above the lower limit plus the entered hysteresis ②, and then falls below the lower limit ③.

Within 'B', two events are counted in the displayed period.

Limits without hysteresis

If you enter the value "zero" in the "Hysteresis" text box, the hysteresis is disabled.

Upper limit without hysteresis (C)

An overrun event is counted when the process value rises above the upper limit^①.

The next overrun event is counted when the process value falls below the upper limit^② by any value, and then rises above the upper limit^②.

Within 'C', three events are counted in the displayed period.

Lower limit without hysteresis (D)

An underrun event is counted when the process value falls below the lower limit^① by any value.

If the process value falls below the lower limit by any value ^②, the next underrun event is counted again.

Two events are counted in the displayed period within 'D'.

See also

Configuring limit monitoring (Page 138)

9.2.8.2 Trend log

Set trend log

1. Select the menu command "Device > Trend log settings".
2. Define the number of process values you wish to log.
3. Use the "Logging behavior" parameter to define the buffer behavior.
 - To fill the buffer with a variable number of logging points between 1 to 735 per process value, select "Fill and stop".
The buffer is deleted and filled up to the number of set logging points. Then logging is stopped.
 - If you select the buffer behavior "Overwrite", the buffer is completely deleted. After the buffer size of 735 logging points per process value has been reached, the 15 oldest logging points are cyclically replaced with 15 new logging points.
4. In the "Logging interval" parameter, enter the interval in seconds between the logging points.
5. Select the process values you want to record.
6. Click on "Transfer" to write the log settings to the device.
The buffer with the existing logging points is deleted and overwritten with new logging points.

Show trend log

1. Select the menu command "Diagnostics > Trend log".
2. Click on "Read".
 - The number of available process values is displayed.
 - The current number of logging points per process value that are already in the buffer is displayed.
 - The time stamp for the start time is displayed.
3. To show the first or second process value in the chart, enable the associated check box.
4. Click on "Read".
 - The logging points in the buffer are read from the device and shown in the chart.
 - The process values for pressure and sensor temperature are shown in different colors in the chart.

When you click on "Reset", the buffer is deleted and trend logging starts again.

9.2.8.3 Operating hours counter

Operating hours counter for transmitter electronics

- Monitors the number of operating hours during which the transmitter remained in continuous operation.
- Starts with the first commissioning at the factory.
- The operating hours counter cannot be reset or adjusted.

Operating hours counter for sensor electronics

- Is only displayed when the measuring transducer electronics was replaced.
- Monitors the number of operating hours during which the sensor electronics remained in continuous operation.

To display the operating time and the operating time sensor, if available, use remote operation (e.g. SIMATIC PDM) to select the menu command "Diagnostics > Device status".

Service and maintenance

10.1 Basic safety instructions

The device is maintenance-free. However, a periodic inspection according to pertinent directives and regulations must be carried out.

An inspection can include, for example, check of:

- Ambient conditions
- Seal integrity of the process connections, cable entries, and cover
- Reliability of power supply, lightning protection, and grounds

 WARNING
Dust layers above 5 mm Risk of explosion in hazardous areas. Device may overheat due to dust build up. <ul style="list-style-type: none">• Remove dust layers in excess of 5 mm.

 WARNING
Use of a computer in a hazardous area If the interface to the computer is used in the hazardous area, there is a risk of explosion. <ul style="list-style-type: none">• Ensure that the atmosphere is explosion-free (hot work permit).

 CAUTION
Releasing button lock Improper modification of parameters could influence process safety. <ul style="list-style-type: none">• Make sure that only authorized personnel may cancel the button locking of devices for safety-related applications.

NOTICE
Penetration of moisture into the device Damage to device. <ul style="list-style-type: none">• Make sure when carrying out cleaning and maintenance work that no moisture penetrates the inside of the device.

10.2 Cleaning

Cleaning the enclosure

- Clean the outside of the enclosure with the inscriptions and the display window using a cloth moistened with water or a mild detergent.
- Do not use any aggressive cleansing agents or solvents, e.g. acetone. Plastic parts or the painted surface could be damaged. The inscriptions could become unreadable.

NOTICE

Improper cleaning of diaphragm

Damage to device. The diaphragm can be damaged.

- Do not use sharp or hard objects to clean the diaphragm.

10.2.1 Servicing the remote seal measuring system

The remote seal measuring system usually does not need servicing.

If the mediums are contaminated, viscous or crystallized, it could be necessary to clean the diaphragm from time to time. Use only a suitable solvent to remove the deposits from the diaphragm. Do not use corrosive cleaning agents. Prevent the diaphragm from getting damaged due to sharp-edged tools.

10.3 Maintenance and repair work

 **WARNING**

Impermissible repair of explosion protected devices

Risk of explosion in hazardous areas

- Repair must be carried out by Siemens authorized personnel only.

 **CAUTION**

Hot surfaces

Risk of burns during maintenance work on parts having surface temperatures exceeding 70 °C (158 °F).

- Take corresponding protective measures, for example by wearing protective gloves.
- After carrying out maintenance, remount touch protection measures.

10.3.1 Defining the maintenance interval

 WARNING
No maintenance interval has been defined Device failure, device damage, and risk of injury. <ul style="list-style-type: none">• Define a maintenance interval for recurring tests depending on the use of the device and your own experience.• The maintenance interval will vary from site to site depending on corrosion resistance.

 WARNING
Maintenance during continued operation in a hazardous area There is a risk of explosion when carrying out repairs and maintenance on the device in a hazardous area. <ul style="list-style-type: none">• Isolate the device from power. - or - <ul style="list-style-type: none">• Ensure that the atmosphere is explosion-free (hot work permit).

 WARNING
Impermissible accessories and spare parts Risk of explosion in areas subject to explosion hazard. <ul style="list-style-type: none">• Only use original accessories or original spare parts.• Observe all relevant installation and safety instructions described in the instructions for the device or enclosed with the accessory or spare part.

 WARNING
Hot, toxic or corrosive process media Risk of injury during maintenance work. When working on the process connection, hot, toxic or corrosive process media could be released. <ul style="list-style-type: none">• As long as the device is under pressure, do not loosen process connections and do not remove any parts that are pressurized.• Before opening or removing the device ensure that process media cannot be released.

 WARNING
Improper connection after maintenance Risk of explosion in areas subject to explosion hazard. <ul style="list-style-type: none">• Connect the device correctly after maintenance.• Close the device after maintenance work. Refer to Technical data (Page 163).

10.3.2 Checking the seals

Inspect the seals at regular intervals

Note

Incorrect seal changes

Incorrect measured values will be displayed. Changing the seals in a process flange of a differential pressure measuring cell can alter the lower range value.

- Changing seals in devices with differential pressure measuring cells may only be carried out by personnel authorized by Siemens.

Note

Using the wrong seals

Using the wrong seals with flush-mounted process connections can cause measuring errors and/or damage the diaphragm.

- Always use seals which comply with the process connection standards or are recommended by Siemens.

1. Clean the enclosure and seals.
2. Check the enclosure and the seals for cracks and damage.
3. If necessary, lubricate the seals or replace them.

10.3.3 Check cable glands

- Check the tightness of the cable glands at regular intervals.
- Tighten the cable glands if necessary.

10.4 Replacing spare parts

10.4.1 Replacing electrical connections and cable entries

Procedure

1. Read the operating data and the approval information on the nameplates of your device.
2. Order a suitable electrical connection or cable entry for your device (cable gland, sealing plug or device plug).
To do this, use the article number "7MF7906-..".

Notes for cable glands and device plugs

- When you order a cable gland or a device plug as spare part, consider the following criteria:
 - Thread
 - Material
 - Approval
 - IP degree of protection
 - Permissible ambient temperature
- The permissible ambient temperature for devices with dust explosion protection deviates from the permissible ambient temperature of the cable gland and the device plug. You should therefore not use any cable glands or device plugs from third-party manufacturers for devices with dust explosion protection.

10.4.2 Replacing the display

10.4.2.1 Removing the display

1. De-energize the device.
2. Use a 3 mm Allen key to loosen the front safety catch.
3. Unscrew the front cover.

4. Remove the display from the holder.

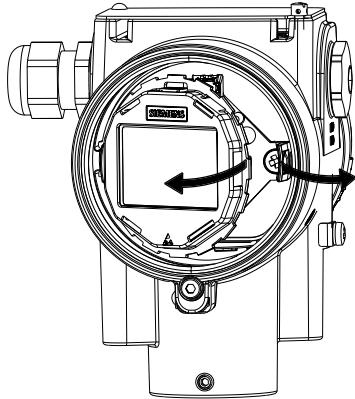

5. Disconnect the cable of the display from the 4-pole connector ①.

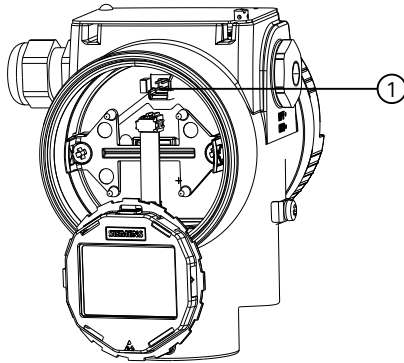

10.4.2.2 Installing the display

1. Connect the cable of the display with the 4-pole connector ① by observing the poling:

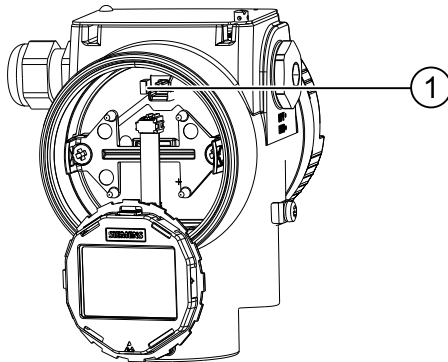

2. Fasten the display in the holder.

10.4.3 Replacing the termination board

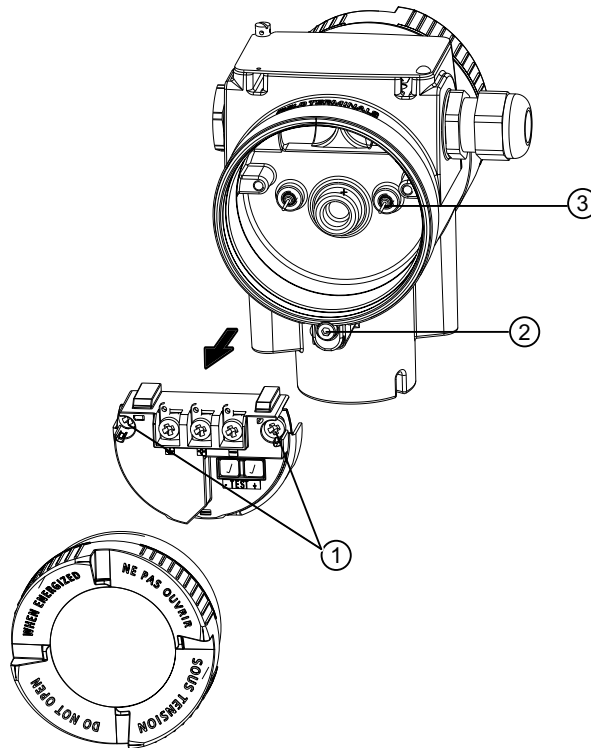

Removing the termination board

1. De-energize the device.
2. Use a 3 mm Allen key to loosen the front safety catch ②.
3. Open the cover of the electronic connection compartment.
4. Disconnect the cables from the termination board.
5. On the left and right side, remove the recessed-head screws ① that hold the termination board to the enclosure.
6. Remove the termination board.

Installing the termination board

1. Insert the new termination board so that its contact pins ③ fit on the rear of the termination board.
2. Work in the reverse order to that described in "Removing the termination board".

10.5 Return procedure

Enclose the bill of lading, return document and decontamination certificate in a clear plastic pouch and attach it firmly to the outside of the packaging.

Required forms

- Delivery note
- Return document (<http://www.siemens.com/processinstrumentation/returngoodsnote>) with the following information:
 - Product (item description)
 - Number of returned devices/replacement parts
 - Reason for returning the item(s)
- Declaration of decontamination (<http://www.siemens.com/sc/declarationofdecontamination>)

With this declaration you warrant "that the device/replacement part has been carefully cleaned and is free of residues. The device/replacement part does not pose a hazard for humans and the environment."

If the returned device/replacement part has come into contact with poisonous, corrosive, flammable or water-contaminating substances, you must thoroughly clean and decontaminate the device/replacement part before returning it in order to ensure that all hollow areas are free from hazardous substances. Check the item after it has been cleaned. Any devices/replacement parts returned without a decontamination declaration will be cleaned at your expense before further processing.

Diagnostics and troubleshooting

11.1 Device status symbols

Device status is shown using symbols on the local display. Additionally, the symbol and respective text message for each device status can be seen in remote engineering, asset management or process control systems.

Locally, alarms are shown as a symbol in the lower line of the display. If several diagnostic states are active at the same time, the symbol for the most critical state is shown.

Device status characteristics

The following table provides possible cause of device status and actions for the user or service.

The symbols used on the local display are based on NAMUR status signals, whereas symbols used in SIMATIC PDM are based on Siemens standard alarm classes.

Note

Device status priority conflict - Namur vs Siemens standard

When more than one diagnostic event is active simultaneously, a conflict in priorities may arise. In this case, the Namur symbol on the local display will differ from that shown in SIMATIC PDM.

- For example: if both diagnostic states "Maintenance demanded" and "Configuration error" are active,
 - Local display (using Namur symbols) will show "Configuration error" as higher priority.
 - SIMATIC PDM (using Siemens standard symbols) will show "Maintenance demanded" as higher priority.



Be aware of the priority for each device status, depending on the interface used.

Note















Priorities of the NAMUR device status





This device only used the priorities of the NAMUR device status based on the NE 107 specification.

Device status symbols

Display – NAMUR NE 107			SIMATIC PDM/PLC		
Symbol	Device status	Priority *	Symbol	Device status	Priority *
	Failure	1		Maintenance alarm	1
<p>Cause: Output signal invalid due to fault in the field device or in the peripherals.</p> <p>Measure: Maintenance is required immediately.</p>					

11.1 Device status symbols

Display – NAMUR NE 107			SIMATIC PDM/PLC		
Symbol	Device status	Priority *	Symbol	Device status	Priority *
	Maintenance re-quired	4		Maintenance demanded	2
<p>Cause:Output signal is still valid, but wear reserve is almost exhausted and/or a function will be limited soon. Measure:Maintenance is strongly recommended as soon as possible.</p>					
	Maintenance re-quired	4		Maintenance required	3
<p>Cause: The output signal is still valid. No functional restrictions have been determined but the wear reserve will most likely be exhausted in the next few weeks. Measure: Maintenance of device should be planned.</p>					
	Function test	2		Manual operation	4
<p>Cause: Output signal temporarily invalid (e.g. frozen) due to work being performed on the device. Measure: Manual mode over HMI or disable the engineering system.</p>					
	Function test	2		Simulation mode	5
<p>Cause: The output signal does temporarily not reflect the process because the output is based on a simulation value. Measure: Simulation mode over HMI or disable the engineering system or restart device.</p>					
	Failure	1		Out of service	6
<p>Cause: The output signal does not represent the process value. The device mode is set to "Out of service". Measure: Disable "Out of service" and enable normal operation.</p>					
	Failure	1	 (red)	Configuration error	7
<p>Cause: Output signal invalid due to parameter setting, connection error or configuration error in the HW. Measure: Check hardware configuration of the device over HMI or engineering system.</p>					
	Out of specifica-tion	3		Process value alarm	8
<p>Cause: Deviations from permissible ambient or process conditions detected by the device (by means of self-monitoring or based on warnings/errors in the device) indicate that the measured value is unreliable or that deviations from the set value in the actuators are most likely greater than anticipated under normal operating conditions. Process or ambient conditions can damage the device or result in unreliable results. Measure: Check ambient temperature or process conditions. If possible, install device at different location.</p>					

Display – NAMUR NE 107			SIMATIC PDM/PLC		
Symbol	Device status	Priority *	Symbol	Device status	Priority *
	Function test	2	 (yellow)	Configuration warning	9
Cause: Safety validation is not complete.					
Measure: Acknowledge safety event in the Functional Safety menu and repeat safety commissioning.					
	Out of specification	3		Process value warning	10
Cause: Deviations from permissible ambient or process conditions detected by the device (by means of self-monitoring or based on warnings/errors in the device) indicate that the measured value is unreliable or that deviations from the set value in the actuators are most likely greater than anticipated under normal operating conditions.					
Process or ambient conditions can damage the device or result in unreliable results.					
Measure: Check ambient temperature or process conditions. If possible, install device at different location.					
No symbol is displayed				Process value tolerance	11
Cause: At least one process value violates one of the process tolerance limits set in the device parameters.					
Measure: Check the parameter settings for limits for this application.					
No symbol is displayed			No symbol is displayed	Configuration changed	12
Cause: The device configuration has changed due to a work process.					
Measure: Reset configuration bit memory to delete the diagnostic message.					
No symbol is displayed	Good – OK		No symbol is displayed	No assignment	13
Cause: Device state ok. No errors from active diagnostics.					
Measure: No action required.					

* The smallest number indicates the highest level of error severity.









** In SIMATIC PDM, the Siemens standard symbol as well as the corresponding NAI symbol is displayed (by the device display).

11.2 Diagnostic messages

The following table shows the IDs of diagnostic messages and possible causes and instructions for corrective actions.









11.2 Diagnostic messages









Depending on the communication and configuration of your device, certain diagnostic messages are not applicable.

ID	Symbols	Message	Cause/Remedy
A0		Event counter 1 Number overruns above threshold Maintenance alarm	The number of overruns of the process value (set in parameters "Upper limit" and "Monitored value") has reached the threshold. Reset and acknowledge event counter. Check process conditions. Check limit monitoring and event counter settings.
A1		Event counter 1 Number underruns above threshold Process value alarm	The number of underruns of the process value (set in parameters "Lower limit" and "Monitored value") has reached the threshold. Reset and acknowledge event counter. Check process conditions. Check limit monitoring and event counter settings.
A2		Event counter 1 Number underruns above threshold Maintenance required	The number of underruns of the process value (set in parameters "Lower limit" and "Monitored value") has reached the threshold. Reset and acknowledge event counter. Check process conditions. Check limit monitoring and event counter settings.
A3		Event counter 1 Number underruns above threshold Maintenance alarm	The number of underruns of the process value (set in parameters "Lower limit" and "Monitored value") has reached the threshold. Reset and acknowledge event counter. Check process conditions. Check limit monitoring and event counter settings.
A4		Event counter 2 Number overruns above threshold Process value alarm	The number of overruns of the process value (set in parameters "Upper limit" and "Monitored value") has reached the threshold. Reset and acknowledge event counter. Check process conditions. Check limit monitoring and event counter settings.
A6		Event counter 2 Number overruns above threshold Maintenance required	The number of overruns of the process value (set in parameters "Upper limit" and "Monitored value") has reached the threshold. Reset and acknowledge event counter. Check process conditions. Check limit monitoring and event counter settings.
A7		Event counter 2 Number overruns above threshold Maintenance alarm	The number of overruns of the process value (set in parameters "Upper limit" and "Monitored value") has reached the threshold. Reset and acknowledge event counter. Check process conditions. Check limit monitoring and event counter settings.
A8		Event counter 2 Number underruns above threshold Process value alarm	The number of underruns of the process value (set in parameters "Lower limit" and "Monitored value") has reached the threshold. Reset and acknowledge event counter. Check process conditions. Check limit monitoring and event counter settings.



















ID	Symbols	Message	Cause/Remedy
A9		Event counter 2 Number underruns above threshold Maintenance required	The number of underruns of the process value (set in parameters "Lower limit" and "Monitored value") has reached the threshold. Reset and acknowledge event counter. Check process conditions. Check limit monitoring and event counter settings.
AA		Device lifetime: Maintenance demanded	Forthcoming end of configured device's lifetime. Maintenance is strongly recommended as soon as possible.
Ab		Device lifetime: Maintenance required	Forthcoming end of configured device's lifetime. Maintenance of device should be planned.
AC		Sensor lifetime: Maintenance demanded	Forthcoming end of configured sensor's lifetime. Maintenance is strongly recommended as soon as possible.
Ad		Sensor lifetime: Maintenance required	Forthcoming end of configured sensor's lifetime. Maintenance of device should be planned.
AE		Service: Maintenance demanded	Forthcoming end of the configured service interval. Maintenance is strongly recommended as soon as possible.
AF		Service: Maintenance required	Forthcoming end of the configured service interval. Maintenance of device should be planned.
AG		Calibration: Maintenance demanded	Forthcoming end of the calibration interval. Maintenance is strongly recommended as soon as possible.
AH		Calibration: Maintenance required	Forthcoming end of the calibration interval. Maintenance of device should be planned.







11.2 Diagnostic messages

ID	Symbols	Message	Cause/Remedy
AJ		Limit monitoring 1 Above limit Process value alarm	Monitored value is above limit (set in parameter "Upper limit").
AL		Limit monitoring 1 Below limit Process value alarm	Monitored value is below limit (set in parameter "Lower limit").
An		Limit monitoring 2 Above limit Process value alarm	Monitored value is above limit (set in parameter "Upper limit").
Ao		Limit monitoring 2 Below limit Process value alarm	Monitored value is below limit (set in parameter "Lower limit").
AU		Event counter 1 Number overruns above threshold Process value alarm	The number of overruns of the process value (set in parameters "Upper limit" and "Monitored value") has reached the threshold. Reset and acknowledge event counter. Check process conditions. Check limit monitoring and event counter settings.
AY		Event counter 1 Number overruns above threshold Maintenance required	The number of overruns of the process value (set in parameters "Upper limit" and "Monitored value") has reached the threshold. Reset and acknowledge event counter. Check process conditions. Check limit monitoring and event counter settings.
bE		Out of service Maintenance alarm	The output signal does not represent the process value. The device mode is set to "Out of service". Repair required. Contact Technical Support.
bL		Device restart due to unexpected program error Maintenance alarm	Watchdog function has detected an internal device error. Restart the device. If the problem persists, contact Technical Support.
bn		Alarm sensor limit exceeded Process value alarm	Process value has reached the sensor limit. Review process conditions versus product specifications.

ID	Symbols	Message	Cause/Remedy
bS		Event counter 2 Number underruns above threshold Maintenance alarm	The number of underruns of the process value (set in parameters "Lower limit" and "Monitored value") has reached the threshold. Reset and acknowledge event counter. Check process conditions. Check limit monitoring and event counter settings.
CA		Simulation mode	The device is in simulation mode and one or more of its device variables are not representative of the process. Disable the simulation to return to normal operation.
Cb		Diagnostics simulated Simulation mode	The device is in simulation mode. Disable the simulation to return to normal operation.
Co		Loop current fixed Manual operation	The loop current is being held at a fixed value and is not responding to process variations. Enter the loop current output value for simulation. Disable the simulation to return to normal operation.
CP		Loop current in saturation Process value warning	The loop current has reached its upper (or lower) saturation limit and cannot increase (or decrease) any further. Adjust loop current scaling.
CU		PV status: uncertain Process value alarm	The value is outside of the physical sensor range. Accuracy may decrease. Check for changes in process conditions or obstructions in vessel.
CY		PV status: bad Maintenance alarm	The measured value is 10% higher than the physical sensor range. Review process conditions versus product specifications. Use a device that fulfills your process conditions.
Fb		Supply voltage below limit. Maintenance demanded	The supply voltage is too low. Make sure input voltage is within product specification.
FC		Supply voltage above limit Maintenance alarm	The supply voltage is too high. Make sure input voltage is within product specification.





11.2 Diagnostic messages

ID	Symbols	Message	Cause/Remedy
FE	 	Loop current read back error Maintenance demanded	The loop current does not correspond to the expected value. Check DAC trim settings. Restore to factory DAC calibration. If the problem persists, contact Technical Support.
FJ	 	Process conditions outside the specification Process value warning	Uncertain values due to process conditions. Check installation for abnormal operating conditions.
Fn	 	Connection error to sensor electronics. Maintenance alarm	Potential product damage. Restart the device. If error continues, sensor electronics may have a defect. Repair required. Contact Technical Support.
Fo	 	Sensor break Maintenance alarm	Potential product damage. Sensor has malfunctioned. A replacement of sensor is recommended. Contact Technical Support.
Fr	 	Internal power supply is out of allowable range. Process value warning	A replacement of the device is recommended. Contact Technical Support.
FS	 	Electronics defect Maintenance alarm	Defect of device electronics. A replacement of the device is recommended. Contact Technical Support.
L		-	The device is write-protected by a jumper.
LA		-	Incorrect PIN entered 3 times. Try again in some minutes.
Lb	  (yellow)	User PIN unchanged Configuration warning	The default user PIN is being used. Enter a new user PIN to optimally protect the device.
LL		-	Button lock is enabled.
LP		-	Parameters and device functions are write-protected with a user PIN.

ID	Symbols	Message	Cause/Remedy
SA		Non-volatile memory check failure Maintenance alarm	Device electronics error. Restart the device. If error continues, device electronics may have a defect. Repair is required. Contact Technical Support.
Sb		Volatile memory check failure Maintenance alarm	Device electronics error. Restart the device. If error continues, device electronics may have a defect. Repair is required. Contact Technical Support.
SC	 (red)	Invalid device configuration Configuration error	One or more of parameters are set to invalid values. Review configuration values and adjust as necessary.
St	  (yellow)	Safety validation mode Configuration warning	Device is in safety validation mode. Complete the functional test and confirm that it was successful in the Functional Safety wizard.
SU		Safety critical device error Maintenance alarm	Acknowledge the error in menu "Functional Safety". If the device does not display an error, repeat the safety start up. If the problem persists, contact Technical Support.

11.3 FOUNDATION Fieldbus

In the Resource Block, you assign the various events to a device status using the following parameters:

Parameter	NAMUR NE107
FD_CHECK_MAP	
FD_OFFSPEC_MAP	
FD_MAINT_MAP	
FD_FAIL_MAP	

Configuration

Note

Display of the device status on the display

The display always shows the device status after the configuration set in the factory.

Exception: For events that are marked with (*) in the following table, the changed device states are transferred to the display.

The device is delivered with the following configuration:

Bit	Event	FD_CHECK_MAP	FD_OFFSPEC_MAP	FD_MAINT_MAP	FD_FAIL_MAP
7	Simulated or substitute value	<input checked="" type="checkbox"/>	<input type="checkbox"/>	<input type="checkbox"/>	<input type="checkbox"/>
8	PV status simulated	<input checked="" type="checkbox"/>	<input type="checkbox"/>	<input type="checkbox"/>	<input type="checkbox"/>
9	Internal power supply is out of permitted range	<input checked="" type="checkbox"/>	<input type="checkbox"/>	<input type="checkbox"/>	<input type="checkbox"/>
10	Process conditions outside the specification	<input type="checkbox"/>	<input checked="" type="checkbox"/>	<input type="checkbox"/>	<input type="checkbox"/>
11	Alarm sensor limit exceeded	<input type="checkbox"/>	<input checked="" type="checkbox"/>	<input type="checkbox"/>	<input type="checkbox"/>
12	Process value 1 above limit*	<input type="checkbox"/>	<input checked="" type="checkbox"/>	<input type="checkbox"/>	<input type="checkbox"/>
13	Process value 1 below limit*	<input type="checkbox"/>	<input checked="" type="checkbox"/>	<input type="checkbox"/>	<input type="checkbox"/>
14	Process value 2 above limit*	<input type="checkbox"/>	<input checked="" type="checkbox"/>	<input type="checkbox"/>	<input type="checkbox"/>
15	Process value 2 below limit*	<input type="checkbox"/>	<input checked="" type="checkbox"/>	<input type="checkbox"/>	<input type="checkbox"/>
18	PV status: uncertain	<input type="checkbox"/>	<input checked="" type="checkbox"/>	<input type="checkbox"/>	<input type="checkbox"/>
19	Process value 1 overrun event counter*	<input type="checkbox"/>	<input checked="" type="checkbox"/>	<input type="checkbox"/>	<input type="checkbox"/>
20	Process value 1 under-run event counter*	<input type="checkbox"/>	<input checked="" type="checkbox"/>	<input type="checkbox"/>	<input type="checkbox"/>
21	Process value 2 overrun event counter*	<input type="checkbox"/>	<input checked="" type="checkbox"/>	<input type="checkbox"/>	<input type="checkbox"/>
22	Process value 2 under-run event counter*	<input type="checkbox"/>	<input checked="" type="checkbox"/>	<input type="checkbox"/>	<input type="checkbox"/>
25	Maintenance required	<input type="checkbox"/>	<input type="checkbox"/>	<input checked="" type="checkbox"/>	<input type="checkbox"/>
26	Maintenance demanded	<input type="checkbox"/>	<input type="checkbox"/>	<input checked="" type="checkbox"/>	<input type="checkbox"/>
27	Device restart due to unexpected program error	<input type="checkbox"/>	<input type="checkbox"/>	<input type="checkbox"/>	<input checked="" type="checkbox"/>
28	Out of service	<input type="checkbox"/>	<input type="checkbox"/>	<input type="checkbox"/>	<input checked="" type="checkbox"/>
29	Connection failure to sensor electronics	<input type="checkbox"/>	<input type="checkbox"/>	<input type="checkbox"/>	<input checked="" type="checkbox"/>

Bit	Event	FD_CHECK_MAP	FD_OFFSPEC_MAP	FD_MAINT_MAP	FD_FAIL_MAP
30	Sensor break	<input type="checkbox"/>	<input type="checkbox"/>	<input type="checkbox"/>	<input checked="" type="checkbox"/>
31	Electronics defect	<input type="checkbox"/>	<input type="checkbox"/>	<input type="checkbox"/>	<input checked="" type="checkbox"/>

11.4 Troubleshooting

Symptom	Cause of error	Remedy
Display empty or shows "INIT"	No or incorrect supply voltage	Check the voltage at the terminals, the connections and the wiring.
Display shows "#####" instead of the current measured value	Value too large to appear on the display	Adjust the unit so that a lower value can be displayed.

Technical data

12.1 Input

12.1.1 Gauge pressure

Gauge pressure input			
Measurand	Gauge pressure		
Measuring span (continuously adjustable) or measuring range, max. operating pressure (in accordance with 2014/68/EU Pressure Equipment Directive) and max. test pressure (in accordance with DIN 16086) (for oxygen measurement, max. 100 bar and 60 °C ambient temperature/ process temperature)	Measuring span ¹⁾	Maximum permissible operating pressure MAWP (PS)	Maximum test pressure
	8.3 ... 250 mbar	4 bar	6 bar
	0.83 ... 25 kPa	0.4 MPa	0.6 MPa
	0.12 ... 3.6 psi	58 psi	87 psi
	0.01 ... 1 bar	6 bar	9 bar
	1 ... 100 kPa	0.6 MPa	0.9 MPa
	0.15 ... 14.5 psi	87 psi	130 psi
	0.04 ... 4 bar	20 bar	30 bar
	4 ... 400 kPa	2 MPa	3 MPa
	0.58 ... 58 psi	290 psi	435 psi
	0.16 ... 16 bar	45 bar	70 bar
	0.016 ... 1.6 MPa	4.5 MPa	7 MPa
	2.3 ... 232 psi	652 psi	1015 psi
	0.63 ... 63 bar	80 bar	120 bar
	0.063 ... 6.3 MPa	8 MPa	12 MPa
	9.1 ... 914 psi	1160 psi	1740 psi
	1.6 ... 160 bar	240 bar	360 bar
	0.16 ... 16 MPa	24 MPa	36 MPa
	23 ... 2321 psi	3480 psi	5221 psi
	4 ... 400 bar	400 bar	600 bar
0.4 ... 40 MPa	40 MPa	60 MPa	
58 ... 5802 psi	5802 psi	8702 psi	
7 ... 700 bar	800 bar	800 bar	
0.7 ... 70 MPa	80 MPa	80 MPa	
102 ... 10153 psi	11603 psi	11603 psi	
Gauge pressure measuring limits			
Low measuring limit ²⁾			
• Measuring cell with silicone oil filling	30 mbar a/3 kPa a/0.44 psi a		

12.1 Input

Gauge pressure measuring limits	
• Measuring cell with inert oil	30 mbar a/3 kPa a/0.44 psi a
• Measuring cell with FDA-compliant oil	100 mbar a/10 kPa a/1.45 psi a
Upper measuring limit	100% of max. range (for oxygen measurement: max. 100 bar/10 MPa/1450 psi and 60 °C ambient temperature/medium temperature)
Lower range value	Between the measuring limits (continuously adjustable)

¹⁾ For devices with functional safety, the minimum permissible measuring span is limited by the turndown. Therefore, ensure that the configured turndown is no higher than 5:1.

²⁾ For 250 mbar/25 kPa/3.6 psi measuring cells, the low measuring limit is 750 mbar a/75 kPa a/ 10.8 psi a. The measuring cell is vacuum-tight down to 30 mbar a/3 kPa a/0.44 psi a.

12.1.2 Gauge pressure with front-flush diaphragm

Gauge pressure input with front-flush diaphragm			
Measurand	Gauge pressure		
Measuring span (continuously adjustable) or measuring range, max. operating pressure and max. test pressure	Measuring span ¹⁾	Maximum permissible operating pressure MAWP (PS)	Maximum test pressure
	0.01 ... 1 bar	Refer to the information on the nameplate of the pressure transmitter and the data on the mounting flange ²⁾	
	1 ... 100 kPa		
	0.15 ... 14.5 psi		
	0.04 ... 4 bar		
	4 ... 400 kPa		
	0.58 ... 58 psi		
	0.16 ... 16 bar		
	0.016 ... 1.6 MPa		
	2.3 ... 232 psi		
0.6 ... 63 bar			
0.063 ... 6.3 MPa			
9.1 ... 914 psi			

¹⁾ For devices with functional safety, the minimum permissible measuring span is limited by the turndown. Therefore, ensure that the configured turndown is no higher than 5:1.

²⁾ The MAWP value of the pressure transmitter can be lower than the PN value of the mounting flange and vice versa. To determine the maximum permissible operating pressure and the maximum permissible test pressure, use the lowest value as reference.

Gauge pressure measuring limits with front-flush diaphragm	
Lower measuring limit	
• Measuring cell with silicone oil filling	100 mbar a/10 kPa a/1.45 psi a
• Measuring cell with inert oil	100 mbar a/10 kPa a/1.45 psi a

Gauge pressure measuring limits with front-flush diaphragm

• Measuring cell with FDA-compliant oil	100 mbar a/10 kPa a/1.45 psi a
Upper measuring limit	100% of max. range

12.1.3 Gauge pressure from the differential pressure series

Gauge pressure input from the differential pressure series

Measurand	Gauge pressure and differential pressure		
Measuring span (continuously adjustable) and maximum operating pressure (according to 2014/68/EU Pressure Equipment Directive)	Measuring span ¹⁾	Maximum permissible operating pressure MAWP (PS)	Max. permissible test pressure
		1 ... 20 mbar	160 bar
0.1 ... 2 kPa		16 MPa	24 MPa
0.4015 ... 8.031 inH ₂ O		2320 psi	3480 psi
	1 ... 60 mbar	160 bar	240 bar
	0.1 ... 6 kPa	16 MPa	24 MPa
	0.4015 ... 24.09 inH ₂ O	2320 psi	3480 psi
	2.5 ... 250 mbar	160 bar	240 bar
	0.2 ... 25 kPa	16 MPa	24 MPa
	1.004 ... 100.4 inH ₂ O	2320 psi	3480 psi
	6 ... 600 mbar	160 bar	240 bar
	0.6 ... 60 kPa	16 MPa	24 MPa
	2.409 ... 240.9 inH ₂ O	2320 psi	3480 psi
	16 ... 1600 mbar	160 bar	240 bar
	1.6 ... 160 kPa	16 MPa	24 MPa
	6.424 ... 642.4 inH ₂ O	2320 psi	3480 psi
	50 ... 5000 mbar	160 bar	240 bar
	5 ... 500 kPa	16 MPa	24 MPa
	20.08 ... 2008 inH ₂ O	2320 psi	3480 psi
	0.3 ... 30 bar	160 bar	240 bar
	0.03 ... 3 MPa	16 MPa	24 MPa
	4.35 ... 435 psi	2320 psi	3480 psi
	8 ... 160 bar	160 bar	240 bar
	0.8 ... 16 MPa	16 MPa	24 MPa
	116 ... 2320 psi	2320 psi	3480 psi

¹⁾ For devices with functional safety, the minimum permissible measuring span is limited by the turndown. Therefore, ensure that the configured turndown is no higher than 5:1.

Gauge pressure measuring limits from differential pressure series

Lower measuring limit

• Measuring cell with silicone oil filling	30 mbar a/3 kPa a/0.44 psi a
--	------------------------------

12.1 Input

Gauge pressure measuring limits from differential pressure series	
• Measuring cell with inert oil	30 mbar a/3 kPa a/0.44 psi a
• Measuring cell with FDA-compliant oil	100 mbar a/10 kPa a/1.45 psi a
Upper measuring limit	100% of max. range (for oxygen measurement: max. 100 bar/10 MPa/1450 psi and 60 °C ambient temperature/medium temperature)
Lower range value	Between the measuring limits (continuously adjustable)

12.1.4 Absolute pressure from the gauge pressure series

Absolute pressure input from the gauge pressure series			
Measurand	Absolute pressure		
Measuring span (continuously adjustable) or measuring range, max. operating pressure (in accordance with 2014/68/EU Pressure Equipment Directive) and max. test pressure (in accordance with DIN 16086)	Measuring span ¹⁾	Maximum permissible operating pressure MAWP (PS)	Maximum test pressure
	8.3 ... 250 mbar a	4 bar a	6 bar a
	0.83 ... 25 kPa a	0.4 MPa a	0.6 MPa a
	3 ... 100 inH ₂ O a	58 psi a	87 psi a
	43 ... 1300 mbar a	6.6 bar a	10 bar a
	4.3 ... 130 kPa a	0.66 MPa a	1 MPa a
	17 ... 525 inH ₂ O a	95 psi a	145 psi a
	166 ... 5000 mbar a	20 bar a	30 bar a
	16.6 ... 500 kPa a	2 MPa a	3 MPa a
	2.41 ... 72.5 psi a	290 psi a	435 psi a
	1 ... 30 bar a	65 bar a	100 bar a
	0.1 ... 3 MPa a	6.5 MPa a	10 MPa a
	14.5 ... 435 psi a	942 psi a	1450 psi a
	5.3 ... 160 bar a	240 bar a	380 bar a
	0.53 ... 16 MPa a	24 MPa a	38 MPa a
	77 ... 2321 psi a	3480 psi a	5511 psi a
	13.3 ... 400 bar a	400 bar a	600 bar a
	1.3 ... 40 MPa a	40 MPa a	60 MPa a
	192 ... 5801 psi a	5801 psi a	8702 psi a
	23.3 ... 700 bar a	800 bar a	800 bar a
2.3 ... 70 MPa a	80 MPa a	80 MPa a	
337 ... 10152 psi a	11603 psi a	11603 psi a	

¹⁾ For devices with functional safety, the minimum permissible measuring span is limited by the turndown. Therefore, ensure that the configured turndown is no higher than 5:1.

Absolute pressure measuring limits from gauge pressure series	
Lower measuring limit	
• Measuring cell with silicone oil filling	0 mbar a/kPa a/psi a

Absolute pressure measuring limits from gauge pressure series

<ul style="list-style-type: none"> Measuring cell with inert oil 	
For process temperature -20 °C < ϑ ≤ 60 °C (-4 °F < ϑ ≤ +140 °F)	30 mbar a/3 kPa a/0.44 psi a
For process temperature 60 °C < ϑ ≤ 100 °C (max. 85 °C for measuring cell 30 bar) (140 °F < ϑ ≤ 212 °F (max. 185 °F for measuring cell 435 psi))	30 mbar a + 20 mbar a • (ϑ - 60 °C)/°C 3 kPa a + 2 kPa a • (ϑ - 60 °C)/°C 0.44 psi a + 0.29 psi a • (ϑ - 140 °F)/°F
Upper measuring limit	100% of max. range (for oxygen measurement: max. 100 bar/10 MPa/1450 psi and 60 °C ambient temperature/medium temperature)
Lower range value	Between the measuring limits (continuously adjustable)

12.1.5 Absolute pressure with front-flush diaphragm

Absolute pressure with front-flush diaphragm

Measurand	Absolute pressure		
Measuring span (continuously adjustable) or measuring range, max. operating pressure and max. test pressure	Measuring span ¹⁾	Maximum permissible operating pressure MAWP (PS)	Maximum test pressure
	43 ... 1300 mbar a	Refer to the information on the nameplate of the pressure transmitter and the data on the mounting flange ²⁾	
	4.3 ... 130 kPa a		
	17 ... 525 inH ₂ O a		
	166 ... 5000 mbar a		
	16.6 ... 500 kPa a		
	2.41 ... 72.5 psi a		
	1 ... 30 bar a		
0.1 ... 3 MPa a			
14.5 ... 435 psi a	Depending on the process connection, the measuring span may differ from these values		

¹⁾ For devices with functional safety, the minimum permissible measuring span is limited by the turndown. Therefore, ensure that the configured turndown is no higher than 5:1.

²⁾ The MAWP value of the pressure transmitter can be lower than the PN value of the mounting flange and vice versa. To determine the maximum permissible operating pressure and the maximum permissible test pressure, use the lowest value as reference.

Absolute pressure measuring limits with front-flush diaphragm

Lower measuring limit	
<ul style="list-style-type: none"> Measuring cell with silicone oil filling 	0 mbar a/kPa a/psi a
Upper measuring limit	100% of max. range
Lower range value	Between the measuring limits (continuously adjustable)

12.1.6 Absolute pressure from the differential pressure series

Absolute pressure input from the differential pressure series			
Measurand	Absolute pressure		
Measuring span (continuously adjustable) and maximum operating pressure (according to 2014/68/EU Pressure Equipment Directive)	Measuring span ¹⁾	Maximum permissible operating pressure MAWP (PS)	Max. permissible test pressure
	8.3 ... 250 mbar a	160 bar a	240 bar a
	0.83 ... 25 kPa a	16 MPa a	24 MPa a
	3 ... 100 inH ₂ O a	2320 psi a	3480 psi a
	43 ... 1300 mbar a	160 bar a	240 bar a
	4.3 ... 130 kPa a	16 MPa a	24 MPa a
	17 ... 525 inH ₂ O a	2320 psi a	3480 psi a
	166 ... 5000 mbar a	160 bar a	240 bar a
	16.6 ... 500 kPa a	16 MPa a	24 MPa a
	2.41 ... 72.5 psi a	2320 psi a	3480 psi a
	1 ... 30 bar a	160 bar a	240 bar a
	0.1 ... 3 MPa a	16 MPa a	24 MPa a
	14.5 ... 435 psi a	2320 psi a	3480 psi a
	8 ... 160 bar a	160 bar a	160 bar a
	0.8 ... 16 MPa a	16 MPa a	16 MPa a
	116 ... 2320 psi a	2320 psi a	2320 psi a

¹⁾ For devices with functional safety, the minimum permissible measuring span is limited by the turndown. Therefore, ensure that the configured turndown is no higher than 5:1.

Absolute pressure measuring limits from differential pressure series

Lower measuring limit	
• Measuring cell with silicone oil filling	0 mbar a/kPa a/psi a
• Measuring cell with inert liquid	
For process temperature $-20\text{ °C} < \vartheta \leq 60\text{ °C}$ ($-4\text{ °F} < \vartheta \leq +140\text{ °F}$)	30 mbar a/3 kPa a/0.44 psi a
For process temperature $60\text{ °C} < \vartheta \leq 100\text{ °C}$ (max. 85 °C for measuring cell 30 bar) ($140\text{ °F} < \vartheta \leq 212\text{ °F}$ (max. 185 °F for measuring cell 435 psi))	30 mbar a + 20 mbar a • $(\vartheta - 60\text{ °C})/^{\circ}\text{C}$ 3 kPa a + 2 kPa a • $(\vartheta - 60\text{ °C})/^{\circ}\text{C}$ 0.44 psi a + 0.29 psi a • $(\vartheta - 140\text{ °F})/^{\circ}\text{F}$
Upper measuring limit	100% of max. range (for oxygen measurement: max. 100 bar/10 MPa/1450 psi and 60 °C ambient temperature/medium temperature)
Lower range value	Between the measuring limits (continuously adjustable)

12.1.7 Differential pressure and flow

Differential pressure and flow rate input, MAWP 160 bar (2320 psi)			
Measurand	Differential pressure and flow		
Measuring span (continuously adjustable) and maximum operating pressure (according to 2014/68/EU Pressure Equipment Directive)	Measuring span ¹⁾	Maximum permissible operating pressure MAWP (PS)	Max. permissible test pressure
	1 ... 20 mbar	0.1 ... 2 kPa	16 MPa
0.4015 ... 8.031 inH ₂ O		2320 psi	3480 psi
1 ... 60 mbar		160 bar	240 bar
0.1 ... 6 kPa	0.4015 ... 24.09 inH ₂ O	2320 psi	3480 psi
	2.5 ... 250 mbar	160 bar	240 bar
	0.2 ... 25 kPa	16 MPa	24 MPa
1.004 ... 100.4 inH ₂ O	6 ... 600 mbar	160 bar	240 bar
	0.6 ... 60 kPa	16 MPa	24 MPa
	2.409 ... 240.9 inH ₂ O	2320 psi	3480 psi
16 ... 1600 mbar	1.6 ... 160 kPa	16 MPa	24 MPa
	6.424 ... 642.4 inH ₂ O	2320 psi	3480 psi
	50 ... 5000 mbar	160 bar	240 bar
5 ... 500 kPa	5 ... 500 kPa	16 MPa	24 MPa
	20.08 ... 2008 inH ₂ O	2320 psi	3480 psi
	0.3 ... 30 bar	160 bar	240 bar
0.03 ... 3 MPa	0.03 ... 3 MPa	16 MPa	24 MPa
	4.35 ... 435 psi	2320 psi	3480 psi
	8 ... 160 bar	160 bar	240 bar
0.8 ... 16 MPa	0.8 ... 16 MPa	16 MPa	24 MPa
	116 ... 2320 psi	2320 psi	3480 psi

12.1 Input

¹⁾ For devices with functional safety, the minimum permissible measuring span is limited by the turndown. Therefore, ensure that the configured turndown is no higher than 5:1.

Differential pressure and flow rate input, MAWP 420 bar (6092 psi)			
Measurand	Differential pressure and flow		
Measuring span (continuously adjustable) or measuring range and maximum operating pressure (according to 2014/68/EU Pressure Equipment Directive)	Measuring span ¹⁾	Maximum operating pressure MAWP (PS)	Max. permissible test pressure
	2.5 ... 250 mbar	420 bar	630 bar
	0.25 ... 25 kPa	42 MPa	63 MPa
	1.004 ... 100.4 inH ₂ O	6091 psi	9137 psi
	6 ... 600 mbar	420 bar	630 bar
	0.6 ... 60 kPa	42 MPa	63 MPa
	2.409 ... 240.9 inH ₂ O	6091 psi	9137 psi
	16 ... 1600 mbar	420 bar	630 bar
	1.6 ... 160 kPa	42 MPa	63 MPa
	6.424 ... 642.4 inH ₂ O	6091 psi	9137 psi
	50 ... 5000 mbar	420 bar	630 bar
	5 ... 500 kPa	42 MPa	63 MPa
	20.08 ... 2008 inH ₂ O	6091 psi	9137 psi
	0.3 ... 30 bar	420 bar	630 bar
	0.03 ... 3 MPa	42 MPa	63 MPa
4.35 ... 435 psi	6091 psi	9137 psi	

¹⁾ For devices with functional safety, the minimum permissible measuring span is limited by the turndown. Therefore, ensure that the configured turndown is no higher than 5:1.

Differential pressure and flow measuring limits		
Lower measuring limit		
<ul style="list-style-type: none"> Measuring cell with silicone oil filling 		
All measuring cells	-100% of maximum measuring range or 30 mbar a /3 kPa a /0.44 psi a	
Measuring cell 160 bar/ 0.16 MPa/ 2320 psi	-25% of maximum measuring range or 30 mbar a /3 kPa a /0.44 psi a	
<ul style="list-style-type: none"> Measuring cell with inert oil 		
	For process temperature -20 °C < θ ≤ 60 °C (-4 °F < θ ≤ +140 °F)	-100% of maximum measuring range or 30 mbar a /3 kPa a /0.44 psi a
	For medium temperature 60 °C < θ ≤ 100 °C (max. 85 °C for measuring cell 30 bar with MAWP 420 bar) (140 °F < θ ≤ 212 °F (max. 185 °F for measuring cell 435 psi))	-100% of maximum measuring range or 30 mbar a /3 kPa a /0.44 psi a 30 mbar a + 20 mbar a • (θ - 60 °C)/°C 3 kPa a + 2 kPa a • (θ - 60 °C)/°C 0.44 psi a + 0.29 psi a • (θ - 140 °F)/°F
<ul style="list-style-type: none"> Measuring cell with FDA-compliant oil 	For process temperature -10 °C < θ ≤ 100 °C (-14 °F < θ ≤ +212 °F)	-100% of maximum measuring range or 100 mbar a /10 kPa a / 14.5 psi a.

Differential pressure and flow measuring limits

Upper measuring limit	100% of max. range (for oxygen measurement: max. 100 bar/10 MPa/1450 psi and 60 °C ambient temperature/medium temperature)
Lower range value	Between the measuring limits (continuously adjustable)

12.1.8 Level

Level input

Measurand	Level	Maximum permissible operating pressure MAWP (PS)	Max. permissible test pressure
Measuring span (continuously adjustable) and maximum operating pressure (according to 2014/68/EU Pressure Equipment Directive)	Measuring span ¹⁾	See mounting flange	
	25 ... 250 mbar		
	2.5 ... 25 kPa		
	10 ... 100 inH ₂ O		
	25 ... 600 mbar		
	2.5 ... 60 kPa		
	10 ... 240 inH ₂ O		
	53 ... 1600 mbar		
	5.3 ... 160 kPa		
	21 ... 640 inH ₂ O		
166 ... 5000 mbar			
16.6 ... 500 kPa			
2.41 ... 72.5 psi			

¹⁾ For devices with functional safety, the minimum permissible measuring span is limited by the turndown. Therefore, ensure that the configured turndown is no higher than 5:1.

Level measuring limits

Lower measuring limit	
Measuring cell with silicone oil filling	-100% of max. measuring range or 30 mbar a/3 kPa a/0.44 psi a depending on the mounting flange
Measuring cell with inert oil	-100% of max. measuring range or 30 mbar a/3 kPa a/0.44 psi a depending on the mounting flange
Measuring cell with FDA-compliant oil	-100% of maximum measuring range or 100 mbar a /10 kPa a /1.45 psi a
Upper measuring limit	100% of max. range
Lower range value	Between the measuring limits (continuously adjustable)

12.2 Measuring accuracy of SITRANS P320

12.2.1 Reference conditions

- According to IEC 62828-1
- Rising characteristic curve
- Lower range value 0 bar/kPa/psi
- Seal diaphragm stainless steel
- Measuring cell with silicone oil filling
- Room temperature 25 °C (77 °F)

12.2.2 Effect of auxiliary power supply

0.005% per 1 V (in percent per change in voltage)

12.2.3 Gauge pressure

Conformity error at limit point setting, including hysteresis and repeatability - gauge pressure

Measuring span ratio r (turndown) $r = \text{max. measuring span/set measuring span and nominal measuring range}$

• Linear characteristic curve	$r \leq 1.25$	$1.25 < r \leq 30$
250 mbar/25 kPa/3.6 psi	$\leq 0.075\%$	$\leq (0.008 \cdot r + 0.065)\%$
• Linear characteristic curve	$r \leq 5$	$5 < r \leq 100$
1 bar/100 kPa/14.5 psi	$\leq 0.065\%$	$\leq (0.004 \cdot r + 0.045)\%$
4 bar/400 kPa/58 psi		
16 bar/1.6 MPa/232 psi		
63 bar/6.3 MPa/914 psi		
160 bar/16 MPa/2321 psi		
• Linear characteristic curve	$r \leq 5$	$5 < r \leq 100$
400 bar/40 MPa/5802 psi	$\leq 0.075\%$	$0.005 \cdot r + 0.05$
700 bar/70 MPa/10152 psi		

Effect of ambient temperature - gauge pressure

In percent per 28 °C (50 °F)

250 mbar/25 kPa/3.6 psi	$\leq (0.16 \cdot r + 0.1)\%$
1 bar/100 kPa/14.5 psi	$\leq (0.05 \cdot r + 0.1)\%$

Effect of ambient temperature - gauge pressure

4 bar/400 kPa/58 psi	$\leq (0.025 \cdot r + 0.125)\%$
16 bar/1.6 MPa/232 psi	
63 bar/6.3 MPa/914 psi	
160 bar/16 MPa/2321 psi	
400 bar/40 MPa/5802 psi	
700 bar/70 MPa/10152 psi	$\leq (0.08 \cdot r + 0.16)\%$

Long-term stability at ± 30 °C (± 54 °F) - gauge pressure

250 mbar/25 kPa/3.6 psi	Per year $\leq (0.25 \cdot r)\%$
1 bar/100 kPa/14.5 psi	In 5 years $\leq (0.25 \cdot r)\%$ In 10 years $\leq (0.35 \cdot r)\%$
4 bar/400 kPa/58 psi	In 5 years $\leq (0.125 \cdot r)\%$
16 bar/1.6 MPa/232 psi	In 10 years $\leq (0.15 \cdot r)\%$
63 bar/6.3 MPa/914 psi	
160 bar/16 MPa/2321 psi	
400 bar/40 MPa/5802 psi	
700 bar/70 MPa/10152 psi	In 5 years $\leq (0.25 \cdot r)\%$ In 10 years $\leq (0.35 \cdot r)\%$

Step response time T_{63} (without electrical damping) - gauge pressure

Approx. 0.105 s

Effect of mounting position - gauge pressure

≤ 0.05 mbar/0.005 kPa/0.000725 psi per 10° incline
(correct the zero point with position error compensation)

12.2.4 Gauge pressure with front-flush diaphragm

Conformity error at limit point setting, including hysteresis and repeatability - gauge pressure with front-flush diaphragm

Measuring span ratio r (turndown)	r = max. measuring span/set measuring span and nominal measuring range	
• Linear characteristic curve	r ≤ 5	5 < r ≤ 100
1 bar/100 kPa/14.5 psi	$\leq 0.075\%$	$\leq (0.005 \cdot r + 0.05)\%$
4 bar/400 kPa/58 psi		
16 bar/1.6 MPa/232 psi		
63 bar/6.3 MPa/914 psi		

12.2 Measuring accuracy of SITRANS P320

Effect of ambient temperature - gauge pressure with front-flush diaphragm	
In percent per 28 °C (50 °F)	
1 bar/100 kPa/14.5 psi	$\leq (0.08 \cdot r + 0.16)\%$
4 bar/400 kPa/58 psi	
16 bar/1.6 MPa/232 psi	
63 bar/6.3 MPa/914 psi	
Long-term stability at ±30 °C (±54 °F) - gauge pressure with front-flush diaphragm	
1 bar/100 kPa/14.5 psi	In 5 years $\leq (0.25 \cdot r)\%$
4 bar/400 kPa/58 psi	
16 bar/1.6 MPa/232 psi	In 5 years $\leq (0.125 \cdot r)\%$
63 bar/6.3 MPa/914 psi	
Step response time T_{63} (without electrical damping) - gauge pressure with front-flush diaphragm	
Approx. 0.105 s	
Effect of mounting position - gauge pressure with front-flush diaphragm	
≤ 0.4 mbar/0.04 kPa/0.006 psi per 10° incline (zero-point correction is possible with position error compensation)	

12.2.5 Gauge pressure from the differential pressure series

Conformity error at limit point setting, including hysteresis and repeatability - gauge pressure from the differential pressure series		
Measuring span ratio r (turndown)	r = max. measuring span/set measuring span and nominal measuring range	
• Linear characteristic curve	$r \leq 5$	$5 < r \leq 20$
20 mbar/2 kPa/8.031 inH ₂ O	$\leq 0.075\%$	$\leq (0.005 \cdot r + 0.05)\%$
• Linear characteristic curve	$r \leq 5$	$5 < r \leq 60$
60 mbar/6 kPa/24.09 inH ₂ O	$\leq 0.075\%$	$\leq (0.005 \cdot r + 0.05)\%$
• Linear characteristic curve	$r \leq 5$	$5 < r \leq 100$
250 mbar/25 kPa/3.6 psi	$\leq 0.065\%$	$\leq (0.004 \cdot r + 0.045)\%$
600 mbar/60 kPa/240.9 inH ₂ O		
1600 mbar/160 kPa/642.4 inH ₂ O		
5000 mbar/500 kPa/2008 inH ₂ O		
30 bar/3 MPa/435 psi		
• Linear characteristic curve	$r \leq 5$	$5 < r \leq 20$
160 bar/16 MPa/2320 psi	$\leq 0.065\%$	$\leq (0.004 \cdot r + 0.045)\%$

Effect of ambient temperature - gauge pressure from differential pressure series

In percent per 28 °C (50 °F)

20 mbar/2 kPa/8.031 inH ₂ O	$\leq (0.15 \cdot r + 0.1)\%$
60 mbar/6 kPa/24.09 inH ₂ O	$\leq (0.075 \cdot r + 0.1)\%$
250 mbar/25 kPa/3.6 psi	$\leq (0.025 \cdot r + 0.125)\%$
600 mbar/60 kPa/240.9 inH ₂ O	
1600 mbar/160 kPa/642.4 inH ₂ O	
5000 mbar/500 kPa/2008 inH ₂ O	
30 bar/3 MPa/435 psi	
160 bar/16 MPa/2320 psi	

Long-term stability at ±30 °C (±54 °F) - gauge pressure from differential pressure series

20 mbar/2 kPa/8.031 inH ₂ O	Per year $\leq (0.2 \cdot r)\%$
60 mbar/6 kPa/24.09 inH ₂ O	In 5 years $\leq (0.25 \cdot r)\%$
250 mbar/25 kPa/3.6 psi	In 5 years $\leq (0.125 \cdot r)\%$
600 mbar/60 kPa/240.9 inH ₂ O	In 10 years $\leq (0.15 \cdot r)\%$
1600 mbar/160 kPa/642.4 inH ₂ O	
5000 mbar/500 kPa/2008 inH ₂ O	
30 bar/3 MPa/435 psi	
160 bar/16 MPa/2320 psi	

Step response time T_{63} (without electrical damping) - gauge pressure from differential pressure series

20 mbar/2 kPa/8.031 inH ₂ O	Approx. 0.160 s
60 mbar/6 kPa/24.09 inH ₂ O	Approx. 0.150 s
250 mbar/25 kPa/3.6 psi	Approx. 0.135 s
600 mbar/60 kPa/240.9 inH ₂ O	
1600 mbar/160 kPa/642.4 inH ₂ O	
5000 mbar/500 kPa/2008 inH ₂ O	
30 bar/3 MPa/435 psi	
160 bar/16 MPa/2320 psi	

Effect of mounting position - gauge pressure from differential pressure series

≤ 0.7 mbar/0.07 kPa/0.01015266 psi per 10° incline
(correct the zero point with position error compensation)

12.2.6 Absolute pressure from the gauge pressure series

Conformity error at limit point setting, including hysteresis and repeatability - Absolute pressure from gauge pressure series		
Measuring span ratio r (turndown)	r = max. measuring span/set measuring span and nominal measuring range	
• Linear characteristic curve	r ≤ 10	10 < r ≤ 30
All measuring cells	≤ 0.1%	≤ 0.2%

Effect of ambient temperature -- Absolute pressure from the gauge pressure series	
In percent per 28 °C (50 °F)	
250 mbar a/25 kPa a/3.6 psi a	≤ (0.15 • r + 0.1)
1300 mbar a/130 kPa a/18.8 psi a	≤ (0.08 • r + 0.16)
5 bar a/500 kPa a/72.5 psi a	
30 bar a/3000 kPa a/435 psi a	
160 bar a/16 MPa a/2321 psi a	
400 bar a/40 MPa a/5802 psi a	
700 bar a/70 MPa a/10152.6 psi a	

Long-term stability at ±30 °C (±54 °F) - Absolute pressure from gauge and differential pressure series	
In 5 years ≤ (0.25 • r)%	

Step response time T₆₃ (without electrical damping) - Absolute pressure from gauge pressure series	
All measuring cells	Approx. 0.105 s

Effect of mounting position - Absolute pressure from the gauge pressure series	
In pressure per change of angle	
≤ 0.05 mbar/0.005 kPa/0.000725 psi per 10° incline	
(zero-point correction is possible using the zero point adjustment)	

12.2.7 Absolute pressure with front-flush diaphragm

Conformity error at limit point setting, including hysteresis and repeatability		
Measuring span ratio r (turndown)	r = max. measuring span/set measuring span and nominal measuring range	
Linear characteristic curve	r ≤ 10	10 < r ≤ 30
All measuring cells	≤ 0.2%	≤ 0.4%

Effect of ambient temperature

In percent per 28 °C (50 °F)

All measuring cells $\leq (0.16 \cdot r + 0.24)$

Long-term stability at ± 30 °C (± 54 °F)

All measuring cells In 5 years $\leq (0.25 \cdot r)\%$

Step response time T_{63} (without electrical damping)

Approx. 0.105 s

Effect of mounting position

In pressure per change of angle

0.04 kPa/0.4 mbar/0.006 psi per 10° incline

(zero-point correction is possible with position error compensation)

12.2.8 Absolute pressure from the differential pressure series

Conformity error at limit point setting, including hysteresis and repeatability - Absolute pressure from the differential pressure series

Measuring span ratio r (turndown)	r = max. measuring span/set measuring span and nominal measuring range		
<ul style="list-style-type: none"> Linear characteristic curve 	$r \leq 5$	$5 < r \leq 30$	
	250 mbar a/25 kPa a/3.6 psi a	$\leq 0.075\%$	$\leq (0.02 \cdot r + 0.05)\%$
	1300 mbar a/130 kPa a/18.8 psi a		$\leq (0.005 \cdot r + 0.05)\%$
	5 bar a/500 kPa a/72.5 psi a		
30 bar a/3000 kPa a/435 psi a			
<ul style="list-style-type: none"> Linear characteristic curve 	$5 < r \leq 20$		
	160 bar a/16 MPa a/2321 psi a	$\leq (0.005 \cdot r + 0.05)\%$	

Effect of the ambient temperature - Absolute pressure from differential pressure series

In percent per 28 °C (50 °F)

250 mbar a/25 kPa a/3.6 psi a $\leq (0.1 \cdot r + 0.1)\%$

1300 mbar a/130 kPa a/18.8 psi a $\leq (0.025 \cdot r + 0.125)\%$

5 bar a/500 kPa a/72.5 psi a

30 bar a/3000 kPa a/435 psi a

160 bar a/16 MPa a/2321 psi a

12.2 Measuring accuracy of SITRANS P320

Long-term stability at ±30 °C (±54 °F) - Absolute pressure from differential pressure series	
250 mbar a/25 kPa a/3.6 psi a	In 5 years ≤ (0.2 • r)%
1300 mbar a/130 kPa a/18.8 psi a	In 5 years ≤ (0.1 • r)%
5 bar a/500 kPa a/72.5 psi a	In 10 years ≤ (0.15 • r)%
30 bar a/3000 kPa a/435 psi a	
160 bar a/16 MPa a/2321 psi a	

Step response time T ₆₃ (without electrical damping) - Absolute pressure from differential pressure series	
250 mbar a/25 kPa a/3.6 psi a	Approx. 0.135 s
1300 mbar a/130 kPa a/18.8 psi a	
5 bar a/500 kPa a/72.5 psi a	
30 bar a/3000 kPa a/435 psi a	
160 bar a/16 MPa a/2321 psi a	

Effect of mounting position - Absolute pressure from differential pressure series	
In pressure per change of angle:	
≤ 0.7 mbar/0.07 kPa/0.001015 psi per 10° incline	
(zero-point correction is possible with position error compensation)	

12.2.9 Differential pressure and flow

Conformity error at limit point setting, including hysteresis and repeatability - differential pressure and flow		
Measuring span ratio r (turndown)	r = max. measuring span/set measuring span and nominal measuring range	
Linear characteristic curve	r ≤ 5	5 < r ≤ 20
20 mbar/2 kPa/0.29 psi	≤ 0.075%	≤ (0.005 • r + 0.05)%
Linear characteristic curve	r ≤ 5	5 < r ≤ 60
60 mbar/6 kPa/0.87 psi	≤ 0.075%	≤ (0.005 • r + 0.05)%
Linear characteristic curve	r ≤ 5	5 < r ≤ 100
250 mbar/25 kPa/3.63 psi	≤ 0.065%	≤ (0.004 • r + 0.045)%
600 mbar/60 kPa/8.70 psi		
1600 mbar/160 kPa/23.21 psi		
5 bar/500 kPa/72.52 psi		
30 bar/3 MPa/435.11 psi		
Linear characteristic curve	r ≤ 5	5 < r ≤ 20
160 bar/16 MPa/2320 psi	≤ 0.065%	≤ (0.004 • r + 0.045)%
Root extraction characteristic	r ≤ 5	5 < r ≤ 20

12.2 Measuring accuracy of SITRANS P320

Conformity error at limit point setting, including hysteresis and repeatability - differential pressure and flow			
Flow > 50%			
20 mbar/2 kPa/0.29 psi	≤ 0.075%	≤ (0.005 • r + 0.05)%	
Root extraction characteristic	r ≤ 5	5 < r ≤ 60	
Flow > 50%			
60 mbar/6 kPa/0.87 psi	≤ 0.075%	≤ (0.005 • r + 0.05)%	
Root extraction characteristic	r ≤ 5	5 < r ≤ 100	
Flow > 50%			
250 mbar/25 kPa/3.63 psi	≤ 0.065%	≤ (0.004 • r + 0.045)%	
600 mbar/60 kPa/8.70 psi			
1600 mbar/160 kPa/23.21 psi			
5 bar/500 kPa/72.52 psi			
30 bar/3 MPa/435.11 psi			
	r ≤ 5	5 < r ≤ 20	
160 bar/16 MPa/2320 psi	≤ 0.065%	≤ (0.004 • r + 0.045)%	
Root extraction characteristic	r ≤ 5	5 < r ≤ 20	
Flow 25 ... 50%			
20 mbar/2 kPa/0.29 psi	≤ 0.15%	≤ (0.01 • r + 0.1)%	
Root extraction characteristic	r ≤ 5	5 < r ≤ 60	
Flow 25 ... 50%			
60 mbar/6 kPa/0.87 psi	≤ 0.15%	≤ (0.01 • r + 0.1)%	
Root extraction characteristic	r ≤ 5	5 < r ≤ 100	
Flow 25 ... 50%			
250 mbar/25 kPa/3.63 psi	≤ 0.13%	≤ (0.008 • r + 0.09)%	
600 mbar/60 kPa/8.70 psi			
1600 mbar/160 kPa/23.21 psi			
5 bar/500 kPa/72.52 psi			
30 bar/3 MPa/435.11 psi			
	r ≤ 5	5 < r ≤ 20	
160 bar/16 MPa/2320 psi	≤ 0.13%	≤ (0.008 • r + 0.09)%	
Effect of ambient temperature - differential pressure and flow			
In percent per 28 °C (50 °F)			
20 mbar/2 kPa/0.29 psi	≤ (0.15 • r + 0.1)%		

12.2 Measuring accuracy of SITRANS P320

Effect of ambient temperature - differential pressure and flow	
60 mbar/6 kPa/0.87 psi	$\leq (0.075 \cdot r + 0.1)\%$
250 mbar/25 kPa/3.63 psi	$\leq (0.025 \cdot r + 0.125)\%$
600 mbar/60 kPa/8.70 psi	
1600 mbar/160 kPa/23.21 psi	
5 bar/500 kPa/72.52 psi	
30 bar/3 MPa/435.11 psi	
160 bar/16 MPa/2320 psi	

Effect of static pressure - differential pressure and flow	
• On the lower range value	
20 mbar/2 kPa/0.29 psi	$\leq (0.3 \cdot r) \%$ per 70 bar (zero-point correction is possible with position error compensation)
60 mbar/6 kPa/0.87 psi	$\leq (0.1 \cdot r)\%$ per 70 bar (zero-point correction is possible with position error compensation)
250 mbar/25 kPa/3.63 psi	
600 mbar/60 kPa/8.70 psi	
1600 mbar/160 kPa/23.21 psi	
30 bar/3 MPa/435.11 psi	
160 bar/16 MPa/2320 psi	
5 bar/500 kPa/72.52 psi	$\leq (0.15 \cdot r)\%$ per 70 bar (zero-point correction is possible with position error compensation)
• On the measuring span	
20 mbar/2 kPa/0.29 psi	$\leq 0.2\%$ per 70 bar
60 mbar/6 kPa/0.87 psi	$\leq 0.1\%$ per 70 bar
250 mbar/25 kPa/3.63 psi	
600 mbar/60 kPa/8.70 psi	
1600 mbar/160 kPa/23.21 psi	
5 bar/500 kPa/72.52 psi	
30 bar/3 MPa/435.11 psi	
160 bar/16 MPa/2320 psi	

Long-term stability at $\pm 30\text{ }^\circ\text{C}$ ($\pm 54\text{ }^\circ\text{F}$) - differential pressure and flow	
Static pressure max. 70 bar/7 MPa/1015 psi	
20 mbar/2 kPa/0.29 psi	Per year $\leq (0.2 \cdot r)\%$
60 mbar/6 kPa/0.87 psi	In 5 years $\leq (0.25 \cdot r)\%$
250 mbar/25 kPa/3.63 psi	In 5 years $\leq (0.125 \cdot r)\%$
600 mbar/60 kPa/8.70 psi	In 10 years $\leq (0.15 \cdot r)\%$
1600 mbar/160 kPa/23.21 psi	
5 bar/500 kPa/72.52 psi	
30 bar/3 MPa/435.11 psi	
160 bar/16 MPa/2320 psi	

Step response time T_{63} (without electrical damping) - Differential pressure and flow (MAWP 160 bar)

20 mbar/2 kPa/0.29 psi	Approx. 0.160 s
60 mbar/6 kPa/0.87 psi	Approx. 0.150 s
250 mbar/25 kPa/3.63 psi 600 mbar/60 kPa/8.70 psi 1600 mbar/160 kPa/23.21 psi 5 bar/500 kPa/72.52 psi 30 bar/3 MPa/435.11 psi 160 bar/16 MPa/2320 psi	Approx. 0.135 s

Step response time T_{63} (without electrical damping) - Differential pressure and flow (MAWP 420 bar)

250 mbar/25 kPa/3.63 psi	Approx. 0.135 s
600 mbar/60 kPa/8.70 psi 1600 mbar/160 kPa/23.21 psi 5 bar/500 kPa/72.52 psi 30 bar/3 MPa/435.11 psi	

Effect of mounting position - differential pressure and flow

In pressure per change of angle
 ≤ 0.7 mbar/0.07 kPa/0.028 inH₂O per 10° incline
 (zero-point correction is possible with position error compensation)

12.2.10 Level

Conformity error at limit point setting, including hysteresis and repeatability - level

Measuring span ratio r (turndown) $r = \text{max. measuring span/set measuring span and nominal measuring range}$

• Linear characteristic curve	$r \leq 5$	$5 < r \leq 10$
250 mbar/25 kPa/3.63 psi 600 mbar/60 kPa/8.70 psi 1600 mbar/160 kPa/23.21 psi 5 bar/500 kPa/72.52 psi	$\leq 0.125\%$	$\leq (0.007 \cdot r + 0.09) \%$

12.3 Measuring accuracy of SITRANS P420

Effect of ambient temperature¹⁾ - level	
In percent per 28 °C (50 °F)	
250 mbar/25 kPa/3.63 psi	$\leq (0.025 \cdot r + 0.125)\%$
600 mbar/60 kPa/8.70 psi	
1600 mbar/160 kPa/23.21 psi	
5 bar/500 kPa/72.52 psi	
1) Data only applies to the basic unit. The error of the remote seal must be considered additively.	
Effect of static pressure - level	
• On the lower range value	
250 mbar/25 kPa/3.63 psi	$\leq (0.1 \cdot r)\%$ per 70 bar (zero-point correction is possible with position error compensation)
600 mbar/60 kPa/8.70 psi	
1600 mbar/160 kPa/23.21 psi	
5 bar/500 kPa/72.52 psi	$\leq (0.15 \cdot r)\%$ per 70 bar (zero-point correction is possible with position error compensation)
• On the measuring span	
	$\leq (0.1 \cdot r)\%$ per 70 bar
Long-term stability at ±30 °C (±54 °F) - level	
All measuring cells	In 5 years $\leq (0.25 \cdot r)\%$ static pressure max. 70 bar/7 MPa/1015 psi
Effect of mounting position - level	
Depends on the fill fluid in the mounting flange	

12.3 Measuring accuracy of SITRANS P420

12.3.1 Reference conditions

- According to IEC 62828-1
- Rising characteristic curve
- Lower range value 0 bar/kPa/psi
- Seal diaphragm stainless steel
- Measuring cell with silicone oil filling
- Room temperature 25 °C (77 °F)

12.3.2 Effect of auxiliary power supply

0.005% per 1 V (in percent per change in voltage)

12.3.3 Gauge pressure

Conformity error at limit point setting, including hysteresis and repeatability - gauge pressure		
Measuring span ratio r (turndown)	r = max. measuring span/set measuring span and nominal measuring range	
• Linear characteristic curve	r ≤ 1.25	1.25 < r ≤ 30
250 mbar/25 kPa/3.6 psi	≤ 0.065%	≤ (0.008 • r + 0.055)%
• Linear characteristic curve	r ≤ 5	5 < r ≤ 100
1 bar/100 kPa/14.5 psi	≤ 0.04%	≤ (0.004 • r + 0.045)%
4 bar/400 kPa/58 psi		
16 bar/1.6 MPa/232 psi		
63 bar/6.3 MPa/914 psi		
160 bar/16 MPa/2321 psi		
• Linear characteristic curve	r ≤ 5	5 < r ≤ 100
400 bar/40 MPa/5802 psi	≤ 0.075%	≤ (0.005 • r + 0.05)%
700 bar/70 MPa/10152 psi		
Effect of ambient temperature - gauge pressure		
In percent per 28 °C (50 °F)		
250 mbar/25 kPa/3.6 psi	≤ (0.16 • r + 0.1)%	
1 bar/100 kPa/14.5 psi	≤ (0.05 • r + 0.1)%	
4 bar/400 kPa/58 psi	≤ (0.025 • r + 0.125)%	
16 bar/1.6 MPa/232 psi		
63 bar/6.3 MPa/914 psi		
160 bar/16 MPa/2321 psi		
400 bar/40 MPa/5802 psi		
700 bar/70 MPa/10152 psi	≤ (0.08 • r + 0.16)%	
Long-term stability at ±30 °C (±54 °F) - gauge pressure		
250 mbar/25 kPa/3.6 psi	Per year ≤ (0.25 • r)%	
1 bar/100 kPa/14.5 psi	In 5 years ≤ (0.25 • r)%	
	In 10 years ≤ (0.35 • r)%	

12.3 Measuring accuracy of SITRANS P420

Long-term stability at ±30 °C (±54 °F) - gauge pressure	
4 bar/400 kPa/58 psi	In 5 years ≤ (0.125 • r)%
16 bar/1.6 MPa/232 psi	In 10 years ≤ (0.15 • r)%
63 bar/6.3 MPa/914 psi	
160 bar/16 MPa/2321 psi	
400 bar/40 MPa/5802 psi	
700 bar/70 MPa/10152 psi	In 5 years ≤ (0.25 • r)%
	In 10 years ≤ (0.35 • r)%

Step response time T ₆₃ (without electrical damping) - gauge pressure
Approx. 0.105 s

Effect of mounting position - gauge pressure
≤ 0.05 mbar/0.005 kPa/0.000725 psi per 10° incline (zero-point correction is possible with position error compensation)

12.3.4 Gauge pressure with front-flush diaphragm

Conformity error at limit point setting, including hysteresis and repeatability - gauge pressure with front-flush diaphragm		
Measuring span ratio r (turndown)	r = max. measuring span/set measuring span and nominal measuring range	
• Linear characteristic curve	r ≤ 5	5 < r ≤ 100
1 bar/100 kPa/14.5 psi	≤ 0.075%	≤ (0.005 • r + 0.05)%
4 bar/400 kPa/58 psi		
16 bar/1.6 MPa/232 psi		
63 bar/6.3 MPa/914 psi		

Effect of ambient temperature - gauge pressure with front-flush diaphragm	
In percent per 28 °C (50 °F)	
1 bar/100 kPa/14.5 psi	≤ (0.08 • r + 0.16)%
4 bar/400 kPa/58 psi	
16 bar/1.6 MPa/232 psi	
63 bar/6.3 MPa/914 psi	

Long-term stability at ±30 °C (±54 °F) - gauge pressure with front-flush diaphragm

1 bar/100 kPa/14.5 psi	In 5 years ≤ (0.25 • r)%
4 bar/400 kPa/58 psi	
16 bar/1.6 MPa/232 psi	In 5 years ≤ (0.125 • r)%
63 bar/6.3 MPa/914 psi	

Step response time T₆₃ (without electrical damping) - gauge pressure with front-flush diaphragm

Approx. 0.105 s

Effect of mounting position - gauge pressure with front-flush diaphragm

≤ 0.4 mbar/0.04 kPa/0.006 psi per 10° incline
(zero-point correction is possible with position error compensation)

12.3.5 Gauge pressure from the differential pressure series

Conformity error at limit point setting, including hysteresis and repeatability - gauge pressure from differential pressure series

Measuring span ratio r (turndown)	r = max. measuring span/set measuring span and nominal measuring range	
• Linear characteristic curve	r ≤ 5	5 < r ≤ 20
20 mbar/2 kPa/8.031 inH ₂ O	≤ 0.075%	≤ (0.005 • r + 0.05)%
• Linear characteristic curve	r ≤ 5	5 < r ≤ 60
60 mbar/6 kPa/24.09 inH ₂ O	≤ 0.075%	≤ (0.005 • r + 0.05)%
• Linear characteristic curve	r ≤ 5	5 < r ≤ 100
250 mbar/25 kPa/3.6 psi	≤ 0.04%	≤ (0.004 • r + 0.045)%
600 mbar/60 kPa/240.9 inH ₂ O		
1600 mbar/160 kPa/642.4 inH ₂ O		
5000 mbar/500 kPa/2008 inH ₂ O		
30 bar/3 MPa/435 psi		
• Linear characteristic curve	r ≤ 5	5 < r ≤ 20
160 bar/16 MPa/2320 psi	≤ 0.04%	≤ (0.004 • r + 0.045)%

Effect of ambient temperature - gauge pressure from differential pressure series

In percent per 28 °C (50 °F)	
20 mbar/2 kPa/8.031 inH ₂ O	≤ (0.15 • r + 0.1)%
60 mbar/6 kPa/24.09 inH ₂ O	≤ (0.075 • r + 0.1)%

12.3 Measuring accuracy of SITRANS P420

Effect of ambient temperature - gauge pressure from differential pressure series	
250 mbar/25 kPa/3.6 psi	$\leq (0.025 \cdot r + 0.0625)\%$
5000 mbar/500 kPa/2008 inH ₂ O	
600 mbar/60 kPa/240.9 inH ₂ O	$\leq (0.0125 \cdot r + 0.0625)\%$
1600 mbar/160 kPa/642.4 inH ₂ O	
30 bar/3 MPa/435 psi	
160 bar/16 MPa/2320 psi	

Long-term stability at ±30 °C (±54 °F) - gauge pressure from differential pressure series	
20 mbar/2 kPa/8.031 inH ₂ O	Per year $\leq (0.2 \cdot r)\%$
60 mbar/6 kPa/24.09 inH ₂ O	In 5 years $\leq (0.25 \cdot r)\%$
250 mbar/25 kPa/3.6 psi	In 5 years $\leq (0.125 \cdot r)\%$
600 mbar/60 kPa/240.9 inH ₂ O	In 10 years $\leq (0.15 \cdot r)\%$
1600 mbar/160 kPa/642.4 inH ₂ O	
5000 mbar/500 kPa/2008 inH ₂ O	
30 bar/3 MPa/435 psi	
160 bar/16 MPa/2320 psi	

Step response time T ₆₃ (without electrical damping) - gauge pressure from differential pressure series	
20 mbar/2 kPa/8.031 inH ₂ O	Approx. 0.160 s
60 mbar/6 kPa/24.09 inH ₂ O	Approx. 0.150 s
250 mbar/25 kPa/3.6 psi	Approx. 0.135 s
600 mbar/60 kPa/240.9 inH ₂ O	
1600 mbar/160 kPa/642.4 inH ₂ O	
5000 mbar/500 kPa/2008 inH ₂ O	
30 bar/3 MPa/435 psi	
160 bar/16 MPa/2320 psi	

Effect of mounting position
≤ 0.7 mbar/0.07 kPa/0.01015266 psi per 10° incline (zero-point correction is possible with position error compensation)

12.3.6 Absolute pressure from the gauge pressure series

Conformity error at limit point setting, including hysteresis and repeatability - Absolute pressure from gauge pressure series		
Measuring span ratio r (turndown)	r = max. measuring span/set measuring span and nominal measuring range	
• Linear characteristic curve	$r \leq 10$	$10 < r \leq 30$
All measuring cells	$\leq 0.1\%$	$\leq 0.2\%$

Effect of ambient temperature -- Absolute pressure from the gauge pressure series

In percent per 28 °C (50 °F)

250 mbar a/25 kPa a/3.6 psi a	$\leq (0.15 \cdot r + 0.1)$
1300 mbar a/130 kPa a/18.8 psi a	$\leq (0.08 \cdot r + 0.16)$
5 bar a/500 kPa a/72.5 psi a	
30 bar a/3000 kPa a/435 psi a	
160 bar a/16 MPa a/2321 psi a	
400 bar a/40 MPa a/5802 psi a	
700 bar a/70 MPa a/10152.6 psi a	

Long-term stability at ±30 °C (±54 °F) - Absolute pressure from gauge and differential pressure series

In 5 years $\leq (0.25 \cdot r)\%$

Step response time T_{63} (without electrical damping) - Absolute pressure from gauge pressure series

All measuring cells Approx. 0.105 s

Effect of mounting position - Absolute pressure from the gauge pressure series

In pressure per change of angle

≤ 0.05 mbar/0.005 kPa/0.000725 psi per 10° incline

(zero-point correction is possible using the zero point adjustment)

12.3.7 Absolute pressure with front-flush diaphragm

Conformity error at limit point setting, including hysteresis and repeatability

Measuring span ratio r (turndown)	$r = \text{max. measuring span/set measuring span and nominal measuring range}$	
Linear characteristic curve	$r \leq 10$	$10 < r \leq 30$
All measuring cells	$\leq 0.2\%$	$\leq 0.4\%$

Effect of ambient temperature

In percent per 28 °C (50 °F)

All measuring cells $\leq (0.16 \cdot r + 0.24)$

Long-term stability at ±30 °C (±54 °F)

All measuring cells In 5 years $\leq (0.25 \cdot r)\%$

12.3 Measuring accuracy of SITRANS P420

Step response time T_{63} (without electrical damping)

Approx. 0.105 s

Effect of mounting position

In pressure per change of angle
 0.04 kPa/0.4 mbar/0.006 psi per 10° incline
 (zero-point correction is possible with position error compensation)

12.3.8 Absolute pressure from the differential pressure series

Conformity error at limit point setting, including hysteresis and repeatability - Absolute pressure from the differential pressure series

Measuring span ratio r (turndown)	$r = \text{max. measuring span/set measuring span and nominal measuring range}$		
<ul style="list-style-type: none"> Linear characteristic curve 	$r \leq 5$	$5 < r \leq 30$	
	250 mbar a/25 kPa a/3.6 psi a	$\leq 0.075\%$	$\leq (0.02 \cdot r + 0.05)\%$
	1300 mbar a/130 kPa a/18.8 psi a		$\leq (0.005 \cdot r + 0.05)\%$
	5 bar a/500 kPa a/72.5 psi a		
30 bar a/3000 kPa a/435 psi a			
<ul style="list-style-type: none"> Linear characteristic curve 		$5 < r \leq 20$	
	160 bar a/16 MPa a/2321 psi a		$\leq (0.005 \cdot r + 0.05)\%$

Effect of the ambient temperature - Absolute pressure from differential pressure series

In percent per 28 °C (50 °F)	
250 mbar a/25 kPa a/3.6 psi a	$\leq (0.1 \cdot r + 0.1)\%$
1300 mbar a/130 kPa a/18.8 psi a	$\leq (0.025 \cdot r + 0.125)\%$
5 bar a/500 kPa a/72.5 psi a	
30 bar a/3000 kPa a/435 psi a	
160 bar a/16 MPa a/2321 psi a	

Long-term stability at ± 30 °C (± 54 °F) - Absolute pressure from differential pressure series

250 mbar a/25 kPa a/3.6 psi a	In 5 years $\leq (0.2 \cdot r)\%$
1300 mbar a/130 kPa a/18.8 psi a	In 5 years $\leq (0.1 \cdot r)\%$
5 bar a/500 kPa a/72.5 psi a	In 10 years $\leq (0.15 \cdot r)\%$
30 bar a/3000 kPa a/435 psi a	
160 bar a/16 MPa a/2321 psi a	

Step response time T_{63} (without electrical damping) - Absolute pressure from differential pressure series

250 mbar a/25 kPa a/3.6 psi a	Approx. 0.135 s
1300 mbar a/130 kPa a/18.8 psi a	
5 bar a/500 kPa a/72.5 psi a	
30 bar a/3000 kPa a/435 psi a	
160 bar a/16 MPa a/2321 psi a	

Effect of mounting position - Absolute pressure from differential pressure series

In pressure per change of angle:
 ≤ 0.7 mbar/0.07 kPa/0.001015 psi per 10° incline
 (zero-point correction is possible with position error compensation)

12.3.9 Differential pressure and flow

Conformity error at limit point setting, including hysteresis and repeatability - differential pressure and flow

Measuring span ratio r (turndown)	r = max. measuring span/set measuring span and nominal measuring range	
Linear characteristic curve	r ≤ 5	5 < r ≤ 20
20 mbar/2 kPa/0.29 psi	≤ 0.075%	≤ (0.005 • r + 0.05)%
Linear characteristic curve	r ≤ 5	5 < r ≤ 60
60 mbar/6 kPa/0.87 psi	≤ 0.075%	≤ (0.005 • r + 0.05)%
Linear characteristic curve	r ≤ 5	5 < r ≤ 100
250 mbar/25 kPa/3.63 psi (MAWP 160 bar (2320 psi))	≤ 0.04%	≤ (0.004 • r + 0.045)%
600 mbar/60 kPa/8.70 psi		
1600 mbar/160 kPa/23.21 psi		
5 bar/500 kPa/72.52 psi		
30 bar/3 MPa/435.11 psi		
250 mbar/25 kPa/3.63 psi (MAWP 420 bar (6092 psi))	≤ 0.065%	
600 mbar/60 kPa/8.70 psi		
1600 mbar/160 kPa/23.21 psi		
5 bar/500 kPa/72.52 psi		
30 bar/3 MPa/435.11 psi		
Linear characteristic curve	r ≤ 5	5 < r ≤ 20
160 bar/16 MPa/2320 psi	≤ 0.04%	≤ (0.004 • r + 0.045)%
Root extraction characteristic	r ≤ 5	5 < r ≤ 20
Flow > 50%		
20 mbar/2 kPa/0.29 psi	≤ 0.075%	≤ (0.005 • r + 0.05)%

12.3 Measuring accuracy of SITRANS P420

Conformity error at limit point setting, including hysteresis and repeatability - differential pressure and flow		
Root extraction characteristic	r ≤ 5	5 < r ≤ 60
Flow > 50%		
60 mbar/6 kPa/0.87 psi	≤ 0.075%	≤ (0.005 • r + 0.05)%
Root extraction characteristic	r ≤ 5	5 < r ≤ 100
Flow > 50%		
250 mbar/25 kPa/3.63 psi	≤ 0.04%	≤ (0.004 • r + 0.045)%
600 mbar/60 kPa/8.70 psi		
1600 mbar/160 kPa/23.21 psi		
5 bar/500 kPa/72.52 psi		
30 bar/3 MPa/435.11 psi		
	r ≤ 5	5 < r ≤ 20
160 bar/16 MPa/2320 psi	≤ 0.04%	≤ (0.004 • r + 0.045)%
Root extraction characteristic	r ≤ 5	5 < r ≤ 20
Flow 25 ... 50%		
20 mbar/2 kPa/0.29 psi	≤ 0.15%	≤ (0.01 • r + 0.1)%
Root extraction characteristic	r ≤ 5	5 < r ≤ 60
Flow 25 ... 50%		
60 mbar/6 kPa/0.87 psi	≤ 0.15%	≤ (0.01 • r + 0.1)%
Root extraction characteristic	r ≤ 5	5 < r ≤ 100
Flow 25 ... 50%		
250 mbar/25 kPa/3.63 psi	≤ 0.08%	≤ (0.008 • r + 0.09)%
600 mbar/60 kPa/8.70 psi		
1600 mbar/160 kPa/23.21 psi		
5 bar/500 kPa/72.52 psi		
30 bar/3 MPa/435.11 psi		
	r ≤ 5	5 < r ≤ 20
160 bar/16 MPa/2320 psi	≤ 0.08%	≤ (0.008 • r + 0.09)%
Effect of ambient temperature - differential pressure and flow		
In percent per 28 °C (50 °F)		
20 mbar/2 kPa/0.29 psi	≤ (0.15 • r + 0.1)%	
60 mbar/6 kPa/0.87 psi	≤ (0.075 • r + 0.1)%	
250 mbar/25 kPa/3.63 psi	≤ (0.025 • r + 0.0625)%	
600 mbar/60 kPa/8.70 psi	≤ (0.0125 • r + 0.0625)%	
1600 mbar/160 kPa/23.21 psi		

Effect of ambient temperature - differential pressure and flow

5 bar/500 kPa/72.52 psi	$\leq (0.025 \cdot r + 0.0625)\%$
30 bar/3 MPa/435.11 psi	$\leq (0.0125 \cdot r + 0.0625)\%$
160 bar/16 MPa/2320 psi	

Effect of static pressure - differential pressure and flow

- On the lower range value

20 mbar/2 kPa/0.29 psi	$\leq (0.2 \cdot r) \% \text{ per } 70 \text{ bar}$ (zero-point correction is possible with position error compensation)
60 mbar/6 kPa/0.87 psi	$\leq (0.1 \cdot r)\%$ per 70 bar (zero-point correction is possible with position error compensation)
250 mbar/25 kPa/3.63 psi	
600 mbar/60 kPa/8.70 psi	
1600 mbar/160 kPa/23.21 psi	
30 bar/3 MPa/435.11 psi	
160 bar/16 MPa/2320 psi	
5 bar/500 kPa/72.52 psi	$\leq (0.15 \cdot r)\%$ per 70 bar (zero-point correction is possible with position error compensation)

- On the measuring span

20 mbar/2 kPa/0.29 psi	$\leq 0.2\%$ per 70 bar
60 mbar/6 kPa/0.87 psi	$\leq 0.1\%$ per 70 bar
250 mbar/25 kPa/3.63 psi	
600 mbar/60 kPa/8.70 psi	
1600 mbar/160 kPa/23.21 psi	
5 bar/500 kPa/72.52 psi	
30 bar/3 MPa/435.11 psi	
160 bar/16 MPa/2320 psi	

Long-term stability at $\pm 30 \text{ }^\circ\text{C}$ ($\pm 54 \text{ }^\circ\text{F}$) - differential pressure and flow

Static pressure max. 70 bar/7 MPa/1015 psi

20 mbar/2 kPa/0.29 psi	Per year $\leq (0.2 \cdot r)\%$
60 mbar/6 kPa/0.87 psi	In 5 years $\leq (0.25 \cdot r)\%$
250 mbar/25 kPa/3.63 psi	In 5 years $\leq (0.125 \cdot r)\%$
600 mbar/60 kPa/8.70 psi	In 10 years $\leq (0.15 \cdot r)\%$
1600 mbar/160 kPa/23.21 psi	
5 bar/500 kPa/72.52 psi	
30 bar/3 MPa/435.11 psi	
160 bar/16 MPa/2320 psi	

Technical data

12.3 Measuring accuracy of SITRANS P420

Step response time T_{63} (without electrical damping) - Differential pressure and flow (MAWP 160 bar)	
20 mbar/2 kPa/0.29 psi	Approx. 0.160 s
60 mbar/6 kPa/0.87 psi	Approx. 0.150 s
250 mbar/25 kPa/3.63 ps 600 mbar/60 kPa/8.70 psi 1600 mbar/160 kPa/23.21 psi 5 bar/500 kPa/72.52 psi 30 bar/3 MPa/435.11 psi 160 bar/16 MPa/2320 psi	Approx. 0.135 s

Step response time T_{63} (without electrical damping) - Differential pressure and flow (MAWP 420 bar)	
250 mbar/25 kPa/3.63 psi	Approx. 0.135 s
600 mbar/60 kPa/8.70 psi 1600 mbar/160 kPa/23.21 psi 5 bar/500 kPa/72.52 psi 30 bar/3 MPa/435.11 psi	Approx. 0.2 s

Effect of mounting position - differential pressure and flow
In pressure per change of angle $\leq 0.7 \text{ mbar}/0.07 \text{ kPa}/0.028 \text{ inH}_2\text{O}$ per 10° incline (zero-point correction is possible with position error compensation)

12.3.10 Level

Conformity error at limit point setting, including hysteresis and repeatability - level		
Measuring span ratio r (turndown)	$r = \text{max. measuring span}/\text{set measuring span and nominal measuring range}$	
• Linear characteristic curve	$r \leq 5$	$5 < r \leq 10$
250 mbar/25 kPa/3.63 psi 600 mbar/60 kPa/8.70 psi 1600 mbar/160 kPa/23.21 psi 5 bar/500 kPa/72.52 psi	$\leq 0.125\%$	$\leq (0.007 \cdot r + 0.09) \%$

Effect of ambient temperature¹⁾ - level	
In percent per 28 °C (50 °F)	
250 mbar/25 kPa/3.63 psi	$\leq (0.025 \cdot r + 0.0625)\%$
5 bar/500 kPa/72.52 psi	
600 mbar/60 kPa/8.70 psi	$\leq (0.125 \cdot r + 0.0625)\%$
1600 mbar/160 kPa/23.21 psi	

¹⁾ Data only applies to the basic unit. The error of the remote seal must be considered additively.

Effect of static pressure - level	
• On the lower range value	
250 mbar/25 kPa/3.63 psi	$\leq (0.3 \cdot r) \%$ per 70 bar (zero-point correction is possible with position error compensation)
600 mbar/60 kPa/8.70 psi	$\leq (0.15 \cdot r)\%$ per 70 bar (zero-point correction is possible with position error compensation)
1600 mbar/160 kPa/23.21 psi	
5 bar/500 kPa/72.52 psi	
• On the measuring span	$\leq (0.1 \cdot r)\%$ per 70 bar

Long-term stability at ±30 °C (±54 °F) - level	
All measuring cells	In 5 years $\leq (0.25 \cdot r)\%$ static pressure max. 70 bar/7 MPa/1015 psi

Effect of mounting position - level	
Depends on the fill fluid in the mounting flange	

12.4 Operating conditions

Operating conditions for gauge pressure and absolute pressure (from the gauge pressure series)	
Ambient conditions	
• Ambient temperature	
	Note: Observe the temperature class in hazardous areas.
Enclosure	-40 ... +100 °C (-40 ... +212 °F)
Measuring cell with silicone oil filling	-40 ... +85 °C (-40 ... +185 °F)
Measuring cell with inert oil	-40 ... +85 °C (-40 ... +185 °F)
Measuring cell with FDA-compliant oil	-10 ... +85 °C (14 ... +185 °F)
Display	-20 ... +80 °C (-4 ... +185 °F)

12.4 Operating conditions

Operating conditions for gauge pressure and absolute pressure (from the gauge pressure series)		
• Storage temperature	-50 ... +85 °C (-58 ... +185 °F) (for FDA-compliant oil: -20 ... + 85 °C (-4 ... +185 °F))	
Climate class in accordance with IEC 60721-3-4	4K26	
Degree of protection according to IEC/EN 60529/UL50-E	Enclosure with appropriate cable gland	IP66/Type 4X IP68 (2 hours at 1.5 m)
	Enclosure with mounted M12 device plug ¹⁾	IP66/Type 4X
	Enclosure with external overvoltage protection up to 6 kV	IP66/Type 4X
	Enclosure with mounted HAN device plug ¹⁾	IP65
Electromagnetic compatibility		
Interference emission and interference immunity	In accordance with EN 61326 and NAMUR NE 21	
Process medium conditions		
• Process temperature		
<i>Cell</i>	<i>Pressure</i>	<i>Temperature range</i>
Measuring cell with sili-cone oil filling		-40 ... +100 °C (-40 ... +212 °F)
Measuring cell with inert oil (gauge pressure)	250 mbar	-40 ... +100 °C (-40 ... +212 °F)
	1 bar/100 kPa/14.5 psi	-40 ... +100 °C (-40 ... +212 °F)
	4 bar/400 kPa/58 psi	-40 ... +100 °C (-40 ... +212 °F)
	16 bar/1.6 MPa/232 psi	-40 ... +100 °C (-40 ... +212 °F)
	63 bar/6.3 MPa/914 psi	-40 ... +100 °C (-40 ... +212 °F)
	160 bar/16 MPa/2321 psi	-20 ... +100 °C (-4 ... +212 °F)
	400 bar/40 MPa/5802 psi	-20 ... +100 °C (-4 ... +212 °F)
	700 bar/70 MPa/10152 psi	-20 ... +100 °C (-4 ... +212 °F)
Measuring cell with inert oil (absolute pressure)		-20 ... +100 °C (-4 ... +212 °F)
Measuring cell with FDA-compliant oil		-10 ... +100 °C (14 ... +212 °F)

¹⁾ Only approved for non-Ex devices and devices with intrinsic safety "Ex i" according to ATEX and IECEx.

Operating conditions for gauge pressure and absolute pressure with front-flush diaphragm	
Ambient conditions	
• Ambient temperature	
Note	Observe the temperature class in hazardous areas.

Operating conditions for gauge pressure and absolute pressure with front-flush diaphragm

Enclosure	-40 ... +100 °C (-40 ... +212 °F)	
Measuring cell with silicone oil filling	-40 ... +85 °C (-40 ... +185 °F)	
Measuring cell with inert oil	-40 ... +85 °C (-40 ... +185 °F)	
Measuring cell with FDA-compliant oil	-10 ... +85 °C (14 ... 185 °F)	
Display	-20 ... +80 °C (-4 ... +176 °F)	
• Storage temperature	-50 ... +85 °C (-58 ... +185 °F) (for FDA-compliant oil: -20 ... + 85 °C (-4 ... +185 °F))	
Climate class in accordance with IEC 60721-3-4	4K26	
Degree of protection according to IEC/EN 60529/UL50-E	Enclosure with appropriate cable gland	IP66/Type 4X IP68 (2 hours at 1.5 m)
	Enclosure with mounted M12 device plug ¹⁾	IP66/Type 4X
	Enclosure with external overvoltage protection up to 6 kV	IP66/Type 4X
	Enclosure with mounted HAN device plug ¹⁾	IP65
Electromagnetic compatibility		
• Interference emission and interference immunity	In accordance with EN 61326 and NAMUR NE 21	
Process medium conditions		
Process temperature ²⁾		
• Measuring cell with silicone oil filling	-40 ... +150°C (-40 ... +302 °F)	
	-40 ... +200°C (-40 ... +392 °F) with cooling extension	
• Measuring cell with inert oil	-20 ... +100 °C (-4 ... +212 °F)	
• Measuring cell with FDA-compliant oil	-10 ... +150°C (14 ... 302 °F)	
	-10 ... +200°C (14 ... 392 °F) with cooling extension	

¹⁾ Only approved for non-Ex devices and devices with intrinsic safety "Ex i" according to ATEX and IECEx.

²⁾ Observe the temperature limits in the process connection standards (e.g. DIN 32676 and DIN 11851) for the maximum medium temperature for flush-mounted process connections.

12.4 Operating conditions

Operating conditions for gauge pressure and absolute pressure (from the differential pressure series), differential pressure and flow

Installation conditions		
<ul style="list-style-type: none"> Measuring cells for differential pressure with MAWP 420 bar 	Dynamic stress according to AD 2000-S1 No. 1.4: <ul style="list-style-type: none"> For MAWP (PS) 420 bar: maximum 1000 load changes At 10% of MAWP (PS): any number of load changes 	
Ambient conditions		
<ul style="list-style-type: none"> Ambient temperature 		
Note	Observe the temperature class in hazardous areas.	
Enclosure	-40 ... +100 °C (-40 ... +212 °F)	
Measuring cell with silicone oil filling	-40 ... +85 °C (-40 ... +185 °F)	
Measuring cell with inert oil	-40 ... +85 °C (-40 ... +185 °F)	
Measuring cell with FDA-compliant oil	-10 ... +85 °C (14 ... 185 °F)	
Display	-20 ... +80 °C (-4 ... +185 °F)	
<ul style="list-style-type: none"> Storage temperature 	-50 ... +85 °C (-58 ... +185 °F) (with FDA-compliant oil: -20 ... +85 °C (-4 ... +185 °F))	
Climate class in accordance with IEC 60721-3-4	4K26	
Degree of protection according to IEC/EN 60529/UL50-E	Enclosure with appropriate cable gland	IP66/Type 4X IP68 (2 hours at 1.5 m)
	Enclosure with mounted M12 device plug ¹⁾	IP66/Type 4X
	Enclosure with external overvoltage protection up to 6 kV	IP66/Type 4X
	Enclosure with mounted HAN device plug ¹⁾	IP65
Electromagnetic compatibility		
Interference emission and interference immunity	In accordance with EN 61326 and NAMUR NE 21	
Process medium conditions		
<ul style="list-style-type: none"> Process temperature 		

Operating conditions for gauge pressure and absolute pressure (from the differential pressure series), differential pressure and flow

Measuring cell with silicone oil filling	-40 ... +100 °C (-40 ... +212 °F)
• Measuring cell 30 bar (435.11 psi)	-20 ... +100°C (-4 ... +212 °F)
• Measuring cell 160 bar (2320 psi) ²⁾	-20 ... +100°C (-4 ... +212 °F)
Measuring cell with inert oil	-20 ... +100 °C (-4 ... +212 °F)
Measuring cell with FDA-compliant oil	-10 ... +100°C (14 ...+212°F)

1) Only approved for non-Ex devices and devices with intrinsic safety "Ex i" according to ATEX and IECEx.

2) With O-rings made of fluoroelastomer (FKM) or perfluoroelastomer (FFKM or FFPM), the medium temperature limit is -10 ... +100°C (14 ... +212°F)

Operating conditions for level

Installation conditions		
• Installation instruction	Specified by the flange	
Ambient conditions		
• Ambient temperature		
Note	Observe the allocation of the max. permissible operating temperature to the max. permissible operating pressure of the relevant flange connection.	
Enclosure	-40 ... +100 °C (-40 ... +212 °F)	
Measuring cell with silicone oil filling	-40 ... +85 °C (-40 ... +185 °F)	
Display	-20 ... +80 °C (-4 ... +185 °F)	
• Storage temperature	-50 ... +85 °C (-58 ... +185 °F)	
Climate class in accordance with IEC 60721-3-4	4K26	
Degree of protection according to IEC/EN 60529/UL50-E	Enclosure with appropriate cable gland	IP66/Type 4X IP68 (2 hours at 1.5 m)
	Enclosure with mounted M12 device plug ¹⁾	IP66/Type 4X
	Enclosure with external overvoltage protection up to 6 kV	IP66/Type 4X
	Enclosure with mounted HAN device plug ¹⁾	IP65
Electromagnetic compatibility		
Interference emission and interference immunity	In accordance with EN 61326 and NAMUR NE 21	
Process medium conditions		

12.5 Vibration resistance

Operating conditions for level

- Process temperature
- | | |
|---|---|
| Measuring cell with sili-cone oil filling | <ul style="list-style-type: none"> • Plus side: See mounting flange • Minus side: -40 ... +100 °C (-40 ... +212 °F) |
|---|---|

¹⁾ Only approved for non-Ex devices and devices with intrinsic safety "Ex i" according to ATEX and IECEx.

12.5 Vibration resistance

General operating conditions	Gauge pressure series ²⁾ Aluminum and stainless steel enclosure	Differential pressure series ¹⁾ Aluminum and stainless steel enclosure
Vibrations (sine) IEC 60068-2-6		2 ... 9 Hz at 0.3 mm 9 ... 200 Hz at 5 m/s ² 1 octave/min 5 cycles/axis
Continuous shocks (half-sine) IEC 60068-2-27		70 m/s ² 30 ms 6 shocks/axis
Continuous shocks (half-sine) IEC 60068-2-27		250 m/s ² 6 ms 1000 shocks/axis

1) Without mounting bracket

2) With mounting bracket

Operating conditions according to KTA 3503	Gauge pressure series ²⁾ Aluminum and stainless steel enclosure	Differential pressure series ²⁾ Aluminum and stainless steel enclosure
Vibrations (sine) IEC 60068-2-6		9 ... 35 Hz at 10 m/s ² 1 octave/min 1 cycle/axis
Vibrations (sine) IEC 60068-2-6		5 ... 7 Hz at 20 mm 9 ... 100 Hz at 20 m/s ² 10 octave/min 1 cycle/axis
Continuous shocks (half-sine) IEC 60068-2-27		300 m/s ² 11 ms 6 shocks/axis

2) With mounting bracket

Operating conditions according to IEC 61298-3 (2g normal)	Gauge pressure series²⁾ Aluminum and stainless steel enclosure	Differential pressure series¹⁾²⁾ Aluminum and stainless steel enclosure
Vibrations (sine) IEC 60068-2-6		10 ... 58 Hz at 0.3 mm 58 ... 1000 Hz at 20 m/s ² 1 octave/min 20 cycles/axis

1) Without mounting bracket

2) With mounting bracket

Operating conditions according to IEC 61298-3 (5g enhanced)	Differential pressure series¹⁾ Aluminum and stainless steel enclosure
Vibrations (sine) IEC 60068-2-6	10 ... 58 Hz at 0.7 mm 58 ... 1000 Hz at 50 m/s ² 1 octave/min 20 cycles/axis

1) Without mounting bracket

Operating conditions for maritime applications according to IEC 60068-2-6	Gauge pressure series¹⁾ Aluminum and stainless steel enclosure	Differential pressure series¹⁾ Aluminum and stainless steel enclosure
DNV-GL (Det Norske Veritas/Germanischer Lloyd) Lloyd's Register Bureau Veritas ABS (American Bureau of Shipping) RINA (Registro Italiano Navale) CCS (China Classification Society)		2 ... 25 Hz at 3.2 mm 25 ... 100 Hz at 40 m/s ² 0.5 octave/min 1 frequency sweep/axis Amplification factor (Q) < 2, 30 Hz/90 min Amplification factor (Q) > 2, resonant frequency/90 min

1) Without mounting bracket

12.6 Construction

Construction for gauge pressure and absolute pressure (from the gauge pressure series)	
Weight	Approx. 1.8 kg (3.9 lb) with aluminum enclosure Approx. 3.8 kg (8.3 lb) with stainless steel enclosure
Material	<ul style="list-style-type: none"> Wetted parts materials

12.6 Construction

Construction for gauge pressure and absolute pressure (from the gauge pressure series)	
Process connection	Stainless steel, material no. 1.4404/316L or Alloy C22, material no. 2.4602
Oval flange	Stainless steel, mat. no. 1.4404/316L
Seal diaphragm	Stainless steel, material no. 1.4404/316L or Alloy C276, material no. 2.4819
• Non-wetted parts materials	
Electronics housing	<ul style="list-style-type: none"> • Low-copper die-cast aluminum GD-ALSi 12 or stainless steel precision casting, mat. no. 1.4409/ CF-3M • Standard: Powder coating with polyurethane Option: 2 coats: Coat 1: epoxy-based; coat 2: Polyurethane • Stainless steel nameplate (1.4404/316L)
Mounting bracket	Steel, galvanized, stainless steel 1.4301/304, stainless steel 1.4404/316L
Process connection	<ul style="list-style-type: none"> • Connection pin G¹/₂A in accordance with DIN EN 837-1 • Female thread ¹/₂-14 NPT • Oval flange (MAWP 160 bar abs (2320 psi g) with fastening screw thread: <ul style="list-style-type: none"> – ⁷/₁₆-20 UNF in accordance with EN 61518 – M10 in accordance with DIN 19213 • Oval flange (MAWP 420 bar abs (MAWP 2320 psi g) with fastening screw thread: <ul style="list-style-type: none"> – ⁷/₁₆-20 UNF in accordance with EN 61518 – M12 in accordance with DIN 19213 • Male thread M20 x 1.5 and ¹/₂-14 NPT
Electrical connection	Cable inlet using the following screwed joints: <ul style="list-style-type: none"> • M20 x 1.5 • ¹/₂-14 NPT • Han 7D/Han 8D connector¹⁾ • M12 connector

¹⁾ Han 8D is identical to Han 8U.

Construction for gauge pressure, with flush mounted diaphragm	
Weight (pressure transmitter without mounting flange)	Approx. 1.8 kg (3.9 lb) with aluminum enclosure Approx. 3.8 kg (8.3 lb) with stainless steel enclosure
Material	
• Wetted parts materials	
Process connection	Stainless steel, mat. no. 1.4404/316L
Seal diaphragm	Stainless steel, material no. 1.4404/316L or Alloy C276, material no. 2.4819
• Non-wetted parts materials	
Electronics housing	<ul style="list-style-type: none"> • Low-copper die-cast aluminum GD-ALSi 12 or stainless steel precision casting, mat. no. 1.4409/CF-3M • Standard: Powder coating with polyurethane D20 option: 2 coats: Coat 1: epoxy-based; coat 2: Polyurethane • Stainless steel nameplate (1.4404/316L)
Mounting bracket	Steel, galvanized, stainless steel 1.4301/304, stainless steel 1.4404/316L

Construction for gauge pressure, with flush mounted diaphragm

Process connection	<ul style="list-style-type: none"> • Flanges as per EN and ASME • F&B and Pharma flange • BioConnect/BioControl • PMC style
--------------------	---

Electrical connection	<p>Cable inlet using the following screwed joints:</p> <ul style="list-style-type: none"> • M20x1.5 • ½-14 NPTM • Han 7D/Han 8D connector¹⁾ • M12 connector
-----------------------	--

¹⁾ Han 8D is identical to Han 8U.

Construction for gauge pressure and absolute pressure (from the differential pressure series), differential pressure and flow rate

Weight	<p>Approx. 3.9 kg (8.5 lb) with aluminum enclosure</p> <p>Approx. 5.9 kg (13 lb) with stainless steel enclosure</p>
--------	---

Material

• Wetted parts materials

Seal diaphragm	Stainless steel, mat. no. 1.4404/316L, Alloy C276, mat. no. 2.4819, Monel 400, mat. no. 2.4360, tantalum or gold
----------------	--

Pressure caps and vents	Stainless steel, mat. no. 1.4408 to MAWP 160 bar, mat. no. 1.4571/316Ti for MAWP 420 bar, Alloy C22, 2.4602 or Monel 400, mat. no. 2.4360
-------------------------	---

O-ring	FKM (Viton) or optionally: PTFE, FEP, FEPM and NBR
--------	--

• Non-wetted parts materials

Electronics housing	<ul style="list-style-type: none"> • Low-copper die-cast aluminum GD-ALSi 12 or stainless steel precision casting, mat. no. 1.4409/CF-3M • Standard: Powder coating with polyurethane D20 option: 2 coats: Coat 1: epoxy-based; coat 2: Polyurethane • Stainless steel nameplate (1.4404/316L)
---------------------	---

Pressure cap screws	Stainless steel ISO 3506-1 A4-70
---------------------	----------------------------------

Mounting bracket	Steel, galvanized, stainless steel 1.4301/304, stainless steel 1.4404/316L
------------------	--

Process connection	¹ / ₄ -18 NPT female thread and flange connection with ⁷ / ₁₆ -20 UNF mounting thread in accordance with EN 61518 or M10 mounting thread in accordance with DIN 19213 (M12 for MAWP 420 bar (6092 psi))
--------------------	---

Electrical connection	<p>Screw terminals</p> <p>Cable inlet using the following screwed joints:</p> <ul style="list-style-type: none"> • M20 x 1.5 • ½-14 NPT • Han 7D/Han 8D connector¹⁾ • M12 connector
-----------------------	--

¹⁾ Han 8D is identical to Han 8U.

12.6 Construction

Construction for level	
Weight	
<ul style="list-style-type: none"> In accordance with EN (pressure transmitter with mounting flange, without tube) 	Approx. 11 ... 13 kg (24.2 ... 28.7 lb) with aluminum enclosure Approx. 13 ... 15 kg (28.7 ... 33 lb) with stainless steel enclosure
<ul style="list-style-type: none"> In accordance with ASME (pressure transmitter with mounting flange, without tube) 	Approx. 11 ... 18 kg (24.2 ... 39.7 lb) with aluminum enclosure Approx. 13 ... 20 kg (28.7 ... 44 lb) with stainless steel enclosure
Material	
<ul style="list-style-type: none"> Wetted parts materials 	
Plus side	
<ul style="list-style-type: none"> Seal diaphragm on the mounting flange 	Stainless steel, mat. no. 1.4404/316L, Monel 400, mat. no. 2.4360, Alloy B2, mat. no. 2.4617, Alloy C276, mat. no. 2.4819, Alloy C22, mat. no. 2.4602, tantalum, PTFE
<ul style="list-style-type: none"> Sealing surface 	Smooth as per EN 1092-1, form B1 or ASME B16.5 RF 125 ... 250 AA for stainless steel 316L, EN 2092-1 form B2 or ASME B16.5 RFSF for the remaining materials
Sealing material in the pressure caps	
<ul style="list-style-type: none"> For standard applications 	FKM (Viton)
<ul style="list-style-type: none"> For underpressure applications on the mounting flange 	Copper
Minus side	
<ul style="list-style-type: none"> Seal diaphragm 	Stainless steel, mat. no. 1.4404/316L
<ul style="list-style-type: none"> Pressure caps locking screws 	Stainless steel, mat. no. 1.4408
<ul style="list-style-type: none"> Locking screw 	Stainless steel ISO 3506-1 A4-70
<ul style="list-style-type: none"> O-ring 	FKM (Viton)
<ul style="list-style-type: none"> Non-wetted parts materials 	
Electronics housing	<ul style="list-style-type: none"> Low-copper die-cast aluminum GD-ALSi 12 or stainless steel precision casting, mat. no. 1.4409/CF-3M Standard: Powder coating with polyurethane D20 option: 2 coats: Coat 1: epoxy-based; coat 2: Polyurethane Stainless steel nameplate (1.4404/316L)
Pressure cap screws	Stainless steel ISO 3506-1 A4-70
Measuring cell filling	Silicone oil
<ul style="list-style-type: none"> Mounting flange fill fluid 	Silicon oil or a different design
Process connection	
<ul style="list-style-type: none"> Plus side 	Flange as per EN and ASME

Construction for level	
• Minus side	¹ / ₄ -18 NPT female thread and flange connection with mounting thread M10 in accordance with DIN 19213 (M12 for MAWP 420 bar (6092 psi)) or ⁷ / ₁₆ -20 UNF in accordance with EN 61518
Electrical connection	Screw terminals Cable inlet using the following screwed joints: <ul style="list-style-type: none"> • M20 x 1.5 • ½-14 NPT • Han 7D/Han 8D connector¹⁾ • M12 connector

¹⁾ Han 8D is identical to Han 8U.

12.7 Torques

Torques	
Connecting terminals	
• Connecting terminals in the connection compartment	1.5 Nm (1.1 ft lb)
• External ground terminal on enclosure	
Cable glands/blanking plugs	
• Screw-in torque for plastic gland in all enclosures	4 Nm (3 ft lb)
• Screw-in torque for metal/stainless steel glands in aluminum/stainless steel enclosure	6 Nm (4.4 ft lb)
• Screw-in torque for NPT adapter made of metal/stainless steel in aluminum/stainless steel enclosure	15 Nm (11.1 ft lb)
• Tightening torque for union nut made of plastic	2.5 Nm (1.8 ft lb)
• Tightening torque for union nut made of metal/stainless steel	4 Nm (3 ft lb)
Screws for mounting bracket (option)	
• Tightening torque for thread M8 or ⁵ / ₁₆ -24 UNF	18 Nm (13.2 ft lb)
• Tightening torque for thread M10 or ⁷ / ₁₆ -20 UNF	36 Nm (26.5 ft lb)
Retaining screws for rotation of the enclosure	
• Tightening torque for aluminum enclosure	3.8 Nm (2.8 ft lb)
• Tightening torque for stainless steel enclosure	3.5 Nm (2.5 ft lb)
Screws for safety catch	
• Tightening torque for aluminum enclosure	0.88 Nm (0.65 ft lb)

12.8 Display, keys and auxiliary power

Display and buttons		
Keys	4 buttons for operation directly on the device	
Display	<ul style="list-style-type: none"> • With or without integrated display (optional) • Cover with glass pane (option) 	
Auxiliary power U_H		
	HART	PROFIBUS PA/FOUNDATION Fieldbus
Terminal voltage on pressure transmitter	<ul style="list-style-type: none"> • DC 10.5 V ... 45 V • In the case of intrinsically safe operation 10.5 V ... 30 V DC 	-
Auxiliary power	-	Bus-powered
Separate supply voltage	-	-
Bus voltage		
• Not 	-	9 ... 32 V
• With intrinsically safe operation	-	9 ... 24 V
Current consumption		
• Max. basic current	-	12.5 mA
• Starting current \leq basic current	-	Yes
• Max. current in event of fault	-	15.5 mA
Fault disconnection electronics (FDE) available	-	Yes
Overvoltage protection up to 6 kV (internal)		
Note	Devices with internal overvoltage protection up to 6 kV do not pass the high voltage test with 700 V DC according to IEC 60079-11. For further information, see the associated certificate for explosion protection.	

12.9 Certificates and approvals

Explosion protection in accordance with ATEX	HART	PROFIBUS PA/FOUNDATION Fieldbus
Certificate	BVS 18 ATEX E049X	
• Intrinsic safety "i"		

Explosion protection in accordance with ATEX	HART	PROFIBUS PA/FOUNDATION Fieldbus
Designation	II 1/2 G Ex ia/ib IIC T4/T6 Ga/Gb II 2G Ex ib IIC T4/T6 Gb	II 1/2G Ex ia IIC T4/T6 Ga/Gb II 2G Ex ib IIC T4/T6 Gb II 3G Ex ic IIC T4/T6 Gc
Permissible ambient temperature	-40 ... +80 °C (-40 ... +176 °F) Temperature class T4 -40 ... +55 °C (-40 ... +158 °F) Temperature class T6	-40 ... +75 °C (-40 ... +167 °F) temperature class T4 -40 ... +50 °C (-40 ... +122 °F) temperature class T6
Permissible temperature of medium	-40 ... +100 °C (-40 ... +212 °F) temperature class T4 -40 ... +70 °C (-40 ... +158 °F) temperature class T6	
Connection	To a certified intrinsically safe circuit with the max. values: $U_i = 30 \text{ V}$, $I_i = 101 \text{ mA}$, $P_i = 760 \text{ mW}$ $U_i = 29 \text{ V}$, $I_i = 110 \text{ mA}$, $P_i = 800 \text{ mW}$	FISCO <ul style="list-style-type: none"> ia/ib: $U_i = 17.5 \text{ V}$, $I_i = 380 \text{ mA}$, $P_i = 5.32 \text{ W}$ ic: $U_i = 17.5 \text{ V}$, $I_i = 570 \text{ mA}$ <hr/> Linear barrier <ul style="list-style-type: none"> ia/ib: $U_i = 24 \text{ V}$, $I_i = 174 \text{ mA}$, $P_i = 1.0 \text{ W}$ ic: $U_i = 32 \text{ V}$, $I_i = 132 \text{ mA}$, $P_i = 1.0 \text{ W}$
Effective inner capacitance	$C_i = 3.29 \text{ nF}$	$C_i = 1.1 \text{ nF}$
Effective inner inductance	$L_i = 0.24 \text{ }\mu\text{H}$	$L_i = 4.8 \text{ }\mu\text{H}$
• Flameproof enclosure encapsulation "d"		
Designation	II 1/2G Ex ia/db IIC T4/T6 Ga/Gb II 2G Ex db ia IIC T4/T6 Gb	
Permissible ambient temperature	-40 ... +80 °C (-40 ... +176 °F) temperature class T4 -40 ... +70 °C (-40 ... +158 °F) temperature class T6	
Permissible temperature of medium	-40 ... +100 °C (-40 ... +212 °F) temperature class T4 -40 ... +70 °C (-40 ... +158 °F) temperature class T6	
Connection	To a circuit with the operating values: $U_H = 10.5 \dots 45 \text{ V DC}$, $4 \dots 20 \text{ mA}$	To a circuit with the operating values: $U_H = 9 \dots 24 \text{ V DC}$
• Dust explosion protection for zones 21, 22		
Designation	II 2D Ex tb IIIC T120 °C Db II 3D Ex tc IIIC T120 °C Dc	
Permissible ambient temperature	-40 ... +80 °C (-40 ... +176 °F)	
Permissible temperature of medium	-40 ... +100 °C (-40 ... +212 °F)	
Max. surface temperature	120°C (248°F)	
Connection	To a circuit with the operating values: $U_H = 10.5 \dots 45 \text{ V DC}$, $4 \dots 20 \text{ mA}$	To a circuit with the operating values: $U_H = 9 \dots 24 \text{ V DC}$
• Dust explosion protection for Zone 20		

12.9 Certificates and approvals

Explosion protection in accordance with ATEX		HART	PROFIBUS PA/FOUNDATION Fieldbus
Designation	II 1D Ex ia III C T120 °C Da		
Permissible ambient temperature	-40 ... +80 °C (-40 ... +176 °F)		-40 ... +75 °C (-40 ... +167 °F)
Permissible temperature of medium	-40 ... +100 °C (-40 ... +212 °F)		
Connection	To a certified intrinsically safe circuit with the max. values: U _i = 30 V, I _i = 101 mA, P _i = 760 mW U _i = 29 V, I _i = 110 mA, P _i = 800 mW	FISCO	<ul style="list-style-type: none"> • ia/ib: U_i = 17.5 V, I_i = 380 mA, P_i = 5.32 W • ic: U_i = 17.5 V, I_i = 570 mA <hr/> Linear barrier <ul style="list-style-type: none"> • ia/ib: U_i = 24 V, I_i = 174 mA, P_i = 1.0 W • ic: U_i = 32 V, I_i = 132 mA, P_i = 1.0 W
Effective inner capacitance	C _i = 3.29 nF	C _i = 1.1 nF	
Effective inner inductance	L _i = 0.24 µH	L _i = 4.8 µH	
• Type of protection for Zone 2			
Designation	II 3G Ex ec IIC T4/T6 Gc		
Permissible ambient temperature "ec"	-40 ... +80 °C (-40 ... +176 °F) temperature class T4 -40 ... +40 °C (-40 ... +104 °F) temperature class T6		
Permissible temperature of medium	-40 ... +100 °C (-40 ... +212 °F) temperature class T4 -40 ... +70 °C (-40 ... +158 °F) temperature class T6		
Connection "ec"	To a circuit with the operating values: U _n = 10.5 to 45 V, 4 ... 20 mA	To a circuit with the operating values: U _H = 9 ... 24 V DC	

Explosion protection in accordance with FM (USA)	HART	PROFIBUS PA/FOUNDATION Fieldbus
FM19US0155X	The permissible operating values are specified in the certificate (http://www.siemens.com/processinstrumentation/certificates).	

12.9 Certificates and approvals

Explosion protection in accordance with FM (USA)		HART	PROFIBUS PA/FOUNDATION Fieldbus
Order variants	Designation		
7MF0...-.....-B..-Z	CL I, DIV 1, Gr. A, B, C, D (IS); T6/T4		CL I, DIV 1, Gr. A, B, C, D (IS); T6/T4
	CL I, ZN 0, AEx ia IIC T6/T4 Ga		CL I, DIV 2, Gr. A, B, C, D (NI); T6/T4
	CL I, ZN 1, AEx ib IIC T6/T4 Gb		CL I, ZN 0, AEx ia IIC T6/T4 Ga
			CL I, ZN 1, AEx ib IIC T6/T4 Gb
			CL I, ZN 2, AEx ic IIC T6/T4 Gc
7MF0...-.....-C..-Z	CL I, DIV 1, Gr. A, B, C, D (XP); T6/T4		
	CL I, ZN 0/1, AEx ia/db IIC T6/T4 Ga/Gb		
7MF0...-.....-D..-Z	CL I, DIV 1, Gr. A, B, C, D (IS); T6/T4		CL I, DIV 1, Gr. A, B, C, D (IS); T6/T4
	CL I, ZN 0, AEx ia IIC T6/T4 Ga		CL I, DIV 2, Gr. A, B, C, D (NI); T6/T4
			CL I, ZN 0, AEx ia IIC T6/T4 Ga
			CL I, ZN 2, AEx ic IIC T6/T4 Gc
	CL I, DIV 1, Gr. A, B, C, D (XP); T6/T4		CL I, DIV 1, Gr. A, B, C, D (XP); T6/T4
	CL I, ZN 0/1, AEx ia/db IIC T4/T6 Ga/Gb		CL I, ZN 0/1, AEx ia/db IIC T4/T6 Ga/Gb
7MF0...-.....-L..-Z	CL I, DIV 2, Gr. A, B, C, D (NI) ; T6/T4		
	CL I, ZN 2, AEx ec IIC T6/T4 Gc		
	CL II, DIV 2, Gr. E, F, G; CL III (NI); T4		
	ZN 21, AEx tb IIIC T120°C Db		
	ZN 22, AEx tc IIIC T120°C Dc		
7MF0...-.....-M..-Z	CL I, DIV 1, Gr. A, B, C, D (IS); T6/T4		CL I, DIV 1, Gr. A, B, C, D (IS); T6/T4
	CL I, DIV 2, Gr. A, B, C, D (NI); T6/T4		CL I, DIV 2, Gr. A, B, C, D (NI); T6/T4
	CL I, ZN 0, AEx ia IIC T6/T4 Ga		CL I, ZN 0, AEx ia IIC T6/T4 Ga
			CL I, ZN 2, AEx ic IIC T6/T4 Gc
	CL I, ZN 2, AEx ec IIC T6/T4 Gc		CL I, ZN 2, AEx ec IIC T6/T4 Gc
	CL II, DIV 1, Gr. E, F, G; CL III (IS); T6/T4		CL II, DIV 1, Gr. E, F, G; CL III (IS); T6/T4
	ZN 20, AEx ia IIIC T120°C Da		ZN 20, AEx ia IIIC T120°C Da
	CL II, DIV 2, Gr. E, F, G; CL III (NI); T4		CL II, DIV 2, Gr. E, F, G; CL III (NI); T4
	ZN 21, AEx tb IIIC T120°C Db		ZN 21, AEx tb IIIC T120°C Db
7MF0...-.....-S..-Z	CL I, ZN 0/1, AEx ia/db IIC T6/T4 Ga/Gb		CL I, ZN 0/1, AEx ia/db IIC T6/T4 Ga/Gb
	CL I, ZN 0, AEx ia IIC T6/T4 Ga		CL I, ZN 0, AEx ia IIC T6/T4 Ga
			CL I, ZN 2, AEx ic IIC T6/T4 Gc
	CL I, ZN 2, AEx ec IIC T6/T4 Gc		CL I, ZN 2, AEx ec IIC T6/T4 Gc
	ZN 21, AEx tb IIIC T120°C Db		ZN 21, AEx tb IIIC T120°C Db
7MF0...-.....-T..-Z	CL I, DIV 1, Gr. A, B, C, D (XP); T6/T4		CL I, DIV 1, Gr. A, B, C, D (XP); T6/T4
	CL I, ZN 0/1, AEx ia/db IIC T6/T4 Ga/Gb		CL I, ZN 0/1, AEx ia/db IIC T6/T4 Ga/Gb
	CL I, DIV 1, Gr. A, B, C, D (IS); T6/T4		CL I, DIV 1, Gr. A, B, C, D (IS); T6/T4
	CL I, DIV 2, Gr. A, B, C, D (NI); T6/T4		CL I, DIV 2, Gr. A, B, C, D (NI); T6/T4
	CL I, ZN 0, AEx ia IIC T6/T4 Ga		CL I, ZN 0, AEx ia IIC T6/T4 Ga
			CL I, ZN 2, AEx ic IIC T6/T4 Gc
	CL I, ZN 2, AEx ec IIC T6/T4 Gc		CL I, ZN 2, AEx ec IIC T6/T4 Gc
	CL II, DIV 2, Gr. E, F, G; CL III (NI); T4		CL II, DIV 2, Gr. E, F, G; CL III (NI); T4

Explosion protection in accordance with FM (USA)	HART	PROFIBUS PA/FOUNDATION Fieldbus
	ZN 21, AEx tb IIIC T120°C Db	ZN 21, AEx tb IIIC T120°C Db

Special conditions for use

1. For type of protection "db": When used as a partition wall device at areas that require EPL Ga, a power supply is required which is safely isolated from earth. This can be achieved, for example, by use of a SELV power supply unit.
2. Potential electrostatic charging hazard: Cleaning of enclosure surfaces should be done with damp cloth.
3. The enclosure shall not be installed in areas with intensive charging processes.
4. For type of protection "ec": Transient protection shall be provided that is set at a level not exceeding 140 % of the peak rated voltage value at the supply input.
5. For type of protection "ec", the equipment shall only be used in an area of at least pollution degree 2, as defined in IEC 60664-1.
6. For type of protection "db", repairs on flame-proof joints can only be done by the original manufacturer.
7. The variant with overvoltage protection 6kV (order option D70) cannot withstand the dielectric strength test with AC voltage. The dielectric strength test shall be performed with a test voltage of 500 VDC for one minute.
8. The plug connection type HAN 7D/8U (A32, A33, A36, A37, A41) and type M12 (A62, A63) and type M12 Anheuser Busch plug (L34) may only be operated as part of an intrinsically safe circuit of up to 30 V maximum. Models containing these plugs are only permitted to be used in hazardous Gas environments, not Dust environments.

Explosion protection in accordance with cCSAus (Canada/USA)

CSA18CA70163103X	The permissible operating values can be found in the certificate.	
Marking (XP/DIP) or (IS); (NI)	According to CSA Standards	Ex ia/db IIC T4/T6 Ga/Gb Ex ia IIC T4/T6 Ga Ex ia IIIC T120°C Da Ex tb IIIC T120°C Db Ex ec IIC T4/T6 Gc Class I, DIV 1, Gr. A-D (Explosion Proof) Intrinsically Safe (IS) for Class I, DIV 1, Gr. A-D (Intrinsically Safe (IS)) Class II, DIV 2, Gr. E-G; Class III Class I, DIV 2, Gr. A-D (NI)
	According to US Standards	Class I, Zone 0/1, AEx ia/db IIC T4/T6 Ga/Gb Class I, Zone 0, AEx ia IIC T4/T6 Ga Zone 20, AEx ia IIIC T120°C Da Zone 21, A/Ex tb IIIC T120°C Db Class I, Zone 2, AEx ec IIC T4/T6 Gc Class I, DIV 1 Gr. A-D (Explosion proof (XP)) Class I, DIV 1 Gr. A-D (Intrinsically Safe (IS)) Class II, DIV 2, Gr. E-G; Class III Class I, DIV 2, Gr. A-D (NI)

Further certificates for explosion protection

Explosion protection in accordance with NEPSI (China)
GYJ19.1058X

The permissible operating values and markings can be found in the certificate (<http://www.siemens.com/processinstrumentation/certificates>).

Explosion protection in accordance with INMETRO (Brazil)

BRA-18-GE-0035X

Explosion protection in accordance with EAC (Russia)

TC RU C-DE.AA87.B.01202

Explosion protection in accordance with IECEx

IECEx BVS 18.0038X

Dimension drawings

13.1 SITRANS P320/P420 for gauge pressure and absolute pressure from the gauge pressure series

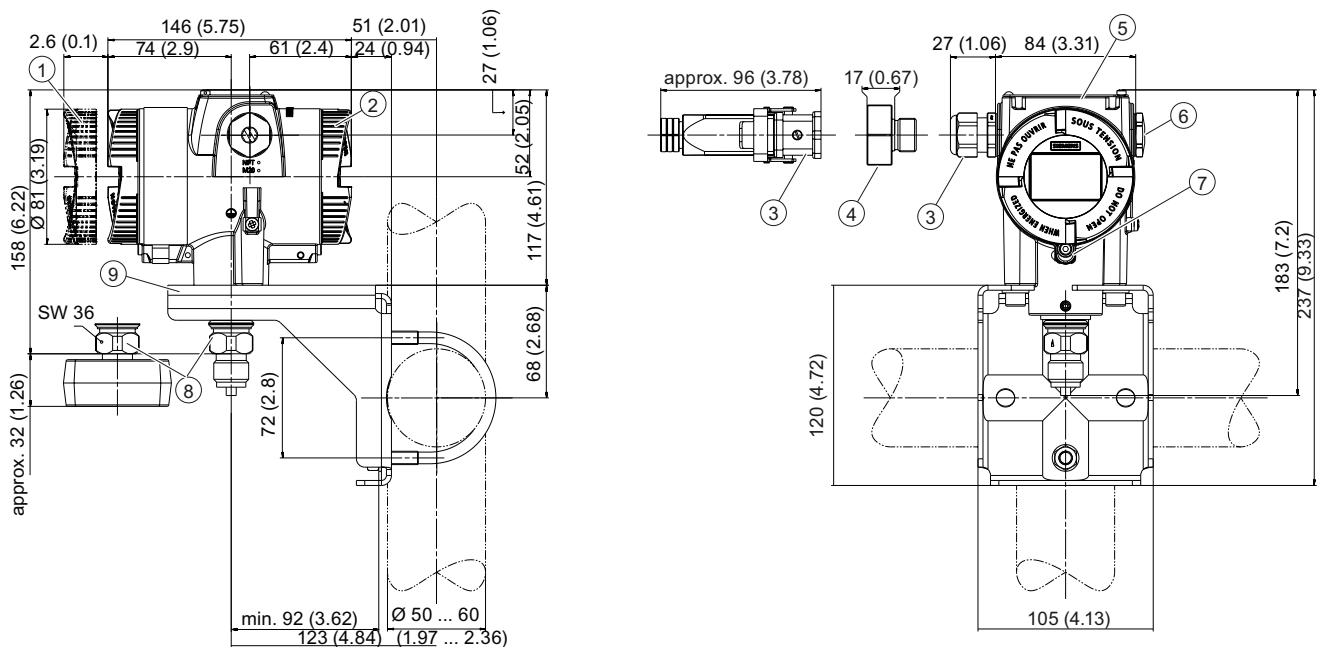

- ① Electronics side, display
(longer for cover with glass pane)¹⁾
- ② Connection end
- ③ Electrical connection:
 - M20 x 1.5 gland³⁾
 - ½-14 NPT gland
 - Han 7D/Han 8D plug^{2) 3)}
 - M12 connector²⁾³⁾
- ④ Harting adapter
- ⑤ Cover over buttons and nameplate with general information
- ⑥ Blanking plug
- ⑦ Safety catch
(only for flameproof enclosure)
- ⑧ Process connection: G½B connection pin or oval flange
- ⑨ Mounting bracket (optional)

¹⁾ In addition, allow approx. 22 mm (0.87 inches) for the thread length when removing the covers

13.1 SITRANS P320/P420 for gauge pressure and absolute pressure from the gauge pressure series

2) Not with "flameproof enclosure" type of protection

3) Not for "FM + CSA [is + XP]" type of protection

Figure 13-1 SITRANS P320 and SITRANS P420 pressure transmitters for absolute pressure, from the gauge pressure series, dimensions in mm (inches)

13.2 SITRANS P320/P420 for differential pressure, gauge pressure, flow and absolute pressure from the differential pressure series

13.2 SITRANS P320/P420 for differential pressure, gauge pressure, flow and absolute pressure from the differential pressure series

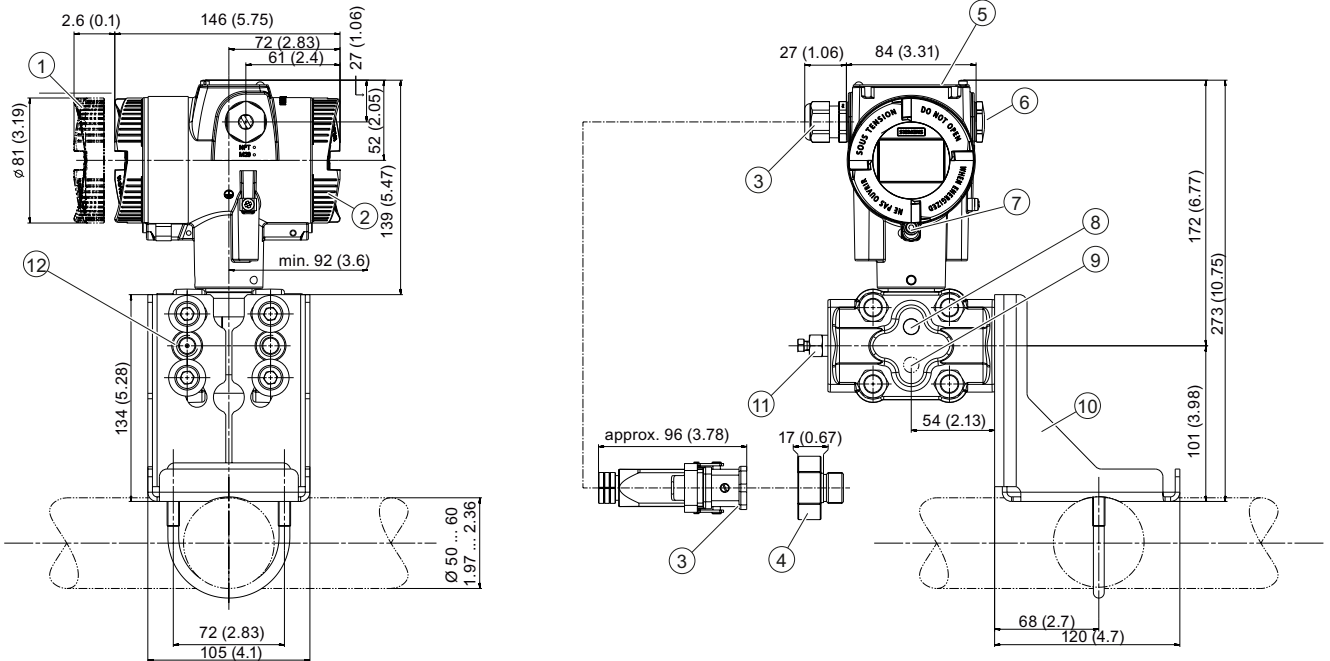

- ① Electronics side, display
(longer for cover with glass pane)¹⁾
- ② Connection end
- ③ Electrical connection:
 - M20 x 1.5 gland
 - 1/2-14 NPT gland
 - Han 7D/Han 8D plug^{2) 3)}
 - M12 connector²⁾³⁾
- ④ Harting adapter
- ⑤ Cover over buttons and nameplate with general information
- ⑥ Blanking plug
- ⑦ Safety catch
(only for "flameproof enclosure" type of protection)
- ⑧ Lateral ventilation for liquid measurement (standard)
- ⑨ Lateral ventilation for gas measurement (order option "K85")
- ⑩ Mounting bracket (optional)
- ⑪ Sealing plug, with valve (optional)
- ⑫ Process connection: 1/4-18 NPT (EN 61518)

¹⁾ In addition, allow approx. 22 mm (0.87 inch) for the thread length when removing the covers

²⁾ Not with "flameproof enclosure" type of protection

³⁾ Not for "FM + CSA [IS + XP]" type of protection

Dimension drawings

13.2 SITRANS P320/P420 for differential pressure, gauge pressure, flow and absolute pressure from the differential pressure series

Figure 13-2 SITRANS P320 and SITRANS P420 pressure transmitters for differential pressure and flow, dimensions in mm (inches)

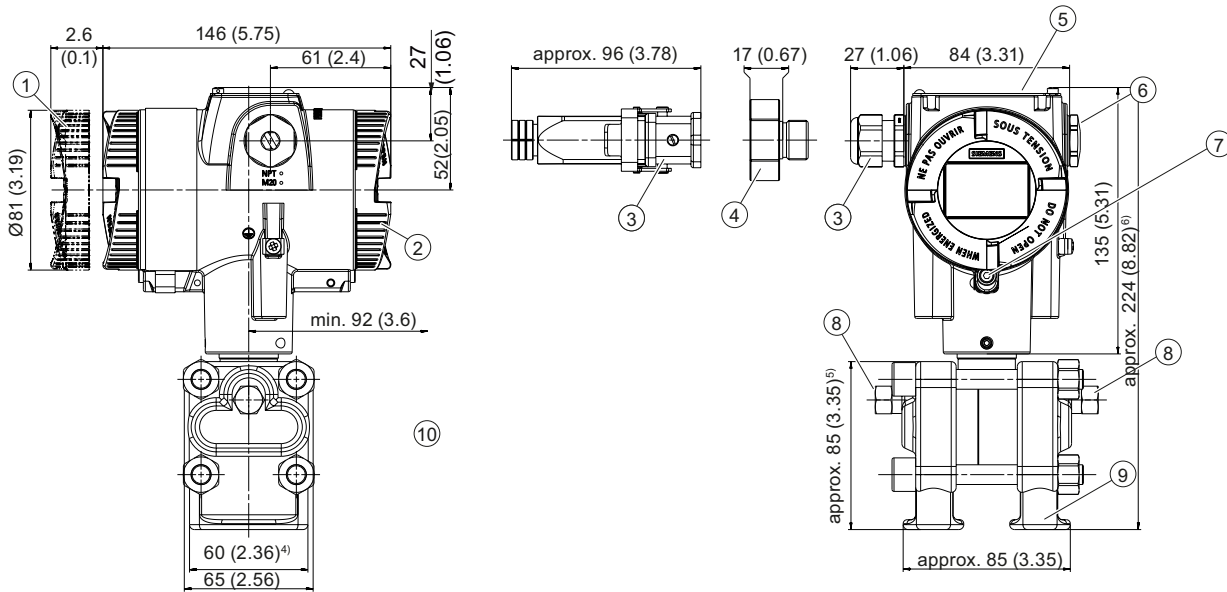

- ① Electronics side, display (longer for cover with inspection window)¹⁾
- ② Connection end
- ③ Electrical connection:
 - M20 x 1.5 gland
 - 1/2-14 NPT gland
 - Han 7D/Han 8D plug²⁾³⁾
 - M12 connector²⁾³⁾
- ④ Harting adapter
- ⑤ Cover over buttons and nameplate with general information
- ⑥ Blanking plug
- ⑦ Safety catch (only for "flameproof enclosure" type of protection)
- ⑧ Sealing plug, with valve (optional)
- ⑨ Process connection: 1/4-18 NPT (IEC 61518)
- ⑩ Clearance for rotating the enclosure

1) In addition, allow approx. 22 mm (0.87 inches) for the thread length when removing the covers

2) Not with "flameproof enclosure" type of protection

3) Not for "FM + CSA [is + XP]" type of protection

4) 74 mm (2.9 inches) for PN ≥ 420 (MAWP ≥ 6092 psi)

5) 91 mm (3.6 inches) for PN ≥ 420 (MAWP ≥ 6092 psi)

6) 226 mm (8.62 inches) for PN ≥ 420 (MAWP ≥ 6092 psi)

Figure 13-3 SITRANS P320 and SITRANS P420 pressure transmitters for differential pressure and flow with process flanges for vertical differential pressure lines (order option "K81"), dimensions in mm (inches)

13.3 SITRANS P 320/P420 for level

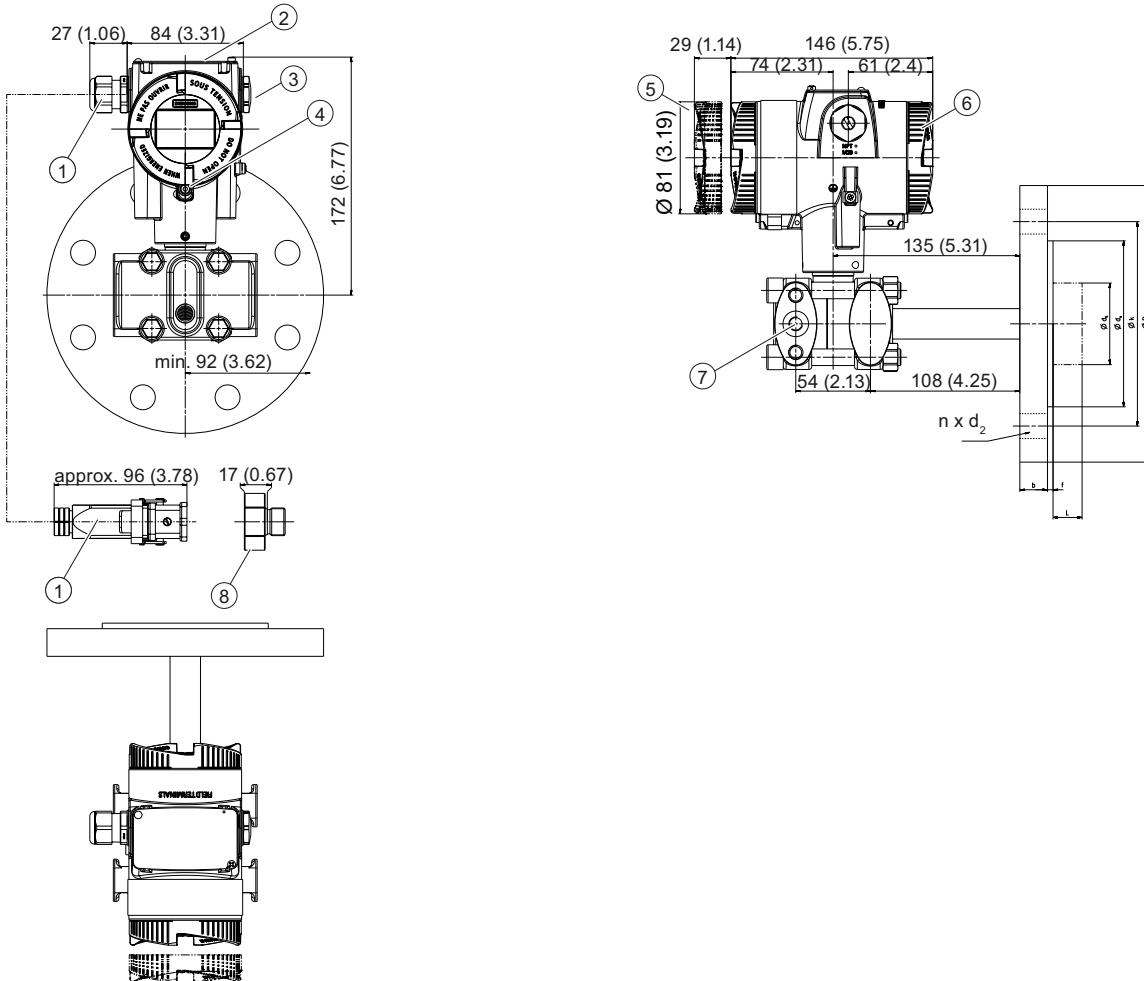

- ① Electrical connection:
 - M20 x 1.5 gland
 - ½-14 NPT gland
 - Han 7D/Han 8D plug^{2) 3)}
 - M12 connector^{2) 3)}
- ② Cover over buttons and nameplate with general information
- ③ Blanking plug
- ④ Safety catch
(only for "flameproof enclosure" type of protection)
- ⑤ Connection end
- ⑥ Electronics side, display
(longer for cover with glass pane)¹⁾
- ⑦ Locking screw
- ⑧ Harting adapter

¹⁾ In addition, allow approx. 22 mm (0.87 inches) for the thread length when removing the covers

13.4 SITRANS P320/P420 (front-flush)

- 2) Not with "flameproof enclosure" type of protection
- 3) Not for "FM + CSA [is + XP]" type of protection

Figure 13-4 SITRANS P320 and SITRANS P420 pressure transmitters for level, including mounting flange, dimensions in mm (inches)

13.4 SITRANS P320/P420 (front-flush)

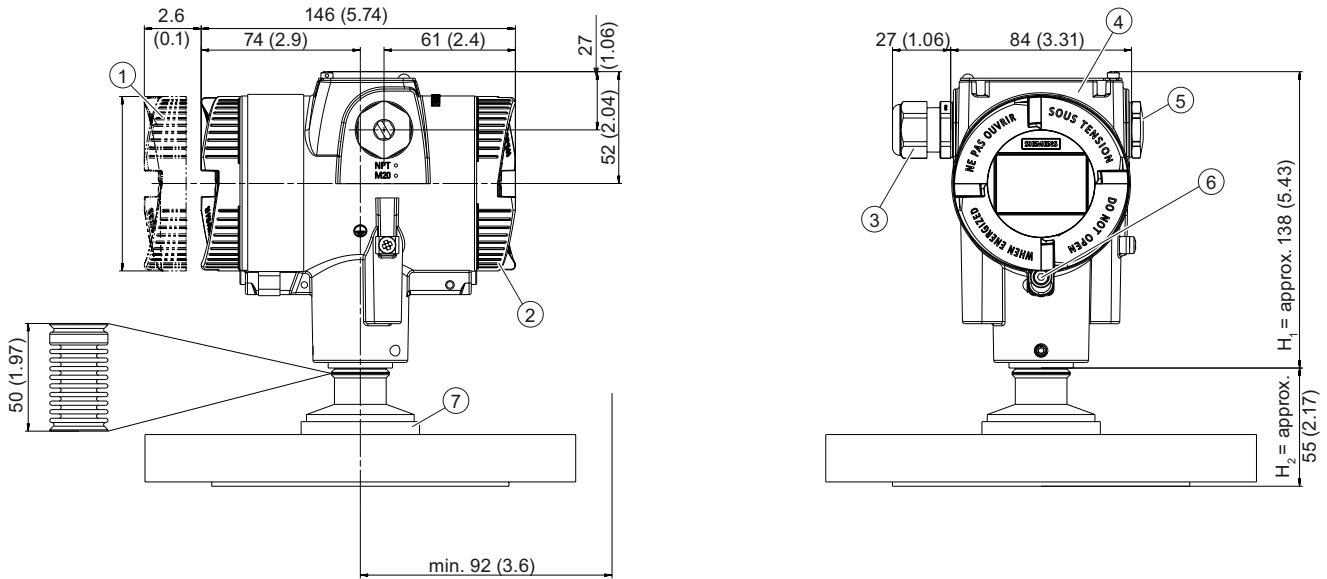

- ① Electronics side, display (longer for cover with glass pane)¹⁾
- ② Connection end
- ③ Electrical connection:
 - M20 x 1.5 gland
 - 1/2-14 NPT gland
 - Han 7D/Han 8D plug^{2) 3)}
 - M12 connector²⁾³⁾
- ④ Cover over buttons and nameplate with general information
- ⑤ Blanking plug
- ⑥ Safety catch (only for "flameproof enclosure" type of protection)
- ⑦ Process connection

1) In addition, allow approx. 22 mm (0.87 inches) for the thread length when removing the covers
 2) Not with "flameproof enclosure" type of protection
 3) Not for "FM + CSA [is + XP]" type of protection

Figure 13-5 SITRANS P320 and SITRANS P420 pressure transmitters (front-flush), dimensions in mm (inches)

13.4.1 Note 3A and EHDG

Note

Approvals

The references to the approvals for "EHEDG" and "3A" refer to the respective process connections and are not device-specific. Please refer to the technical specifications of the respective pressure transmitter to see whether the desired certificate is available for your device/flange combination.

13.4.2 Connections as per EN and ASME

Flange according to EN

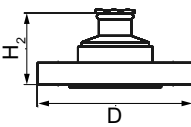
EN 1092-1				
	DN	PN	∅D	H ₂
	25	40	115 mm (4.5")	Approx. 52 mm (2")
	40	40	150 mm (5.9")	
	40	100	170 mm (6.7")	
	50	16	165 mm (6.5")	
	50	40	165 mm (6.5")	
	80	16	200 mm (7.9")	
	80	40	200 mm (7.9")	

Threaded connections

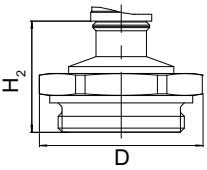
G3/4", G1" and G2" In accordance with DIN 3852				
	DN	PN	∅D	H ₂
	3/4"	60	37 mm (1.5")	approx. 45 mm (1.8")
	1"	60	48 mm (1.9")	approx. 47 mm (1.9")
	2"	60	78 mm (3.1")	Approx. 52 mm (2")

Flange according to ASME

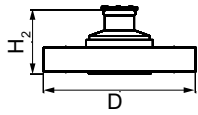
ASME B 16.5				
	DN	CLASS	ØD	H ₂
	1"	150	110 mm (4.3")	Approx. 52 mm (2")
	1½"	150	125 mm (4.9")	
	1½"	300	155 mm (6.1")	
	2"	150	150 mm (5.9")	
	2"	300	165 mm (6.5")	
	3"	150	190 mm (7.5")	
	3"	300	210 mm (8.1")	
	4"	150	230 mm (9.1")	
	4"	300	255 mm (10.0")	

13.4.3 F&B and pharma flange

Connections as per DIN

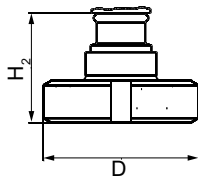
DIN 11851				
	DN	PN	ØD	H ₂
	50	25	92 mm (3.6")	Approx. 52 mm (2")
	80	25	127 mm (5.0")	

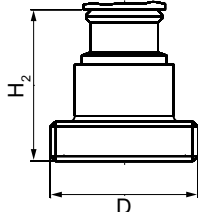
DIN 11864-1 Form A - sterile threaded sockets				
	DN	PN	ØD	H ₂
	50	25	78 mm (2")	Approx. 52 mm (2")
	65	25	95 mm (3.7")	
	80	25	110 mm (4.3")	
	100	25	130 mm (5.1")	

Approvals	EHEDG
-----------	-------

DIN 11864-2 Form A - sterile collar flange

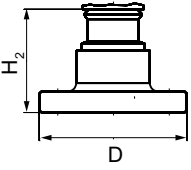
	DN	PN	ØD	H ₂
	50	16	94 mm (3.7")	Approx. 52 mm (2")
	65	16	113 mm (4.4")	
	80	16	133 mm (5.2")	
	100	16	159 mm (6.3")	

Approvals EHEDG

DIN 11864-2 Form A - sterile groove flange

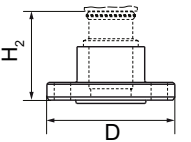
	DN	PN	ØD	H ₂
	50	16	94 mm (3.7")	Approx. 52 mm (2")
	65	16	113 mm (4.4")	
	80	16	133 mm (5.2")	
	100	16	159 mm (6.3")	

Approvals EHEDG

DIN 11864-3 Form A - sterile collar sockets

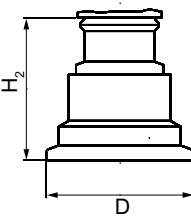
	DN	PN	ØD	H ₂
	50	25	77.5 mm (3.1")	Approx. 52 mm (2")
	65	25	91 mm (3.6")	
	80	16	106 mm (4.2")	
	100	16	130 mm (5.1")	

Approvals EHEDG

Tri-Clamp as per DIN 32676

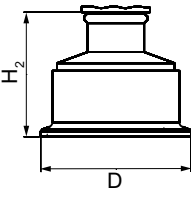
	DN	PN	ØD	H ₂
	50	16	64 mm (2.5")	Approx. 52 mm (2")
	65	16	91 mm (3.6")	
	2"	16	64 mm (2.5")	
	3"	10	91 mm (3.6")	

Other connections

Varivent® connector				
	DN	PN	∅D	H ₂
	40-125	40	84 mm (3.3")	Approx. 52 mm (2")

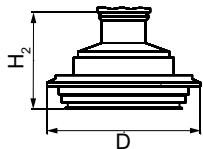

Approvals	EHEDG			
-----------	-------	--	--	--

Connection in accordance with DRD				
	DN	PN	∅D	H ₂
	65	40	105 mm (4.1")	Approx. 52 mm (2")

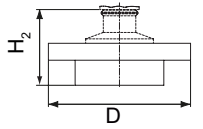

13.4.4 PMC Style

Connections for the paper industry

PMC Style Standard				
	DN	PN	∅D	H ₂
	-	-	40.9 mm (1.6")	Approx. 36.8 mm (1.4")
	M44x1.25 cap nut			

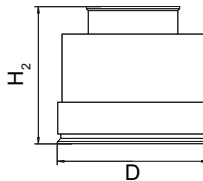

PMC-Style Minibolt

DN	PN	∅D	H ₂
–	–	26.3 mm (1.0")	Approx. 33.1 mm (1.3")

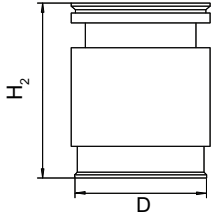

13.4.5 Special connections

Tank connection

TG52/50 and TG52/150

DN	PN	∅D	H ₂
TG52/50			
25	40	63 mm (2.5")	Approx. 63 mm (2.5")
TG52/150			
25	40	63 mm (2.5")	Approx. 170 mm (6.7")

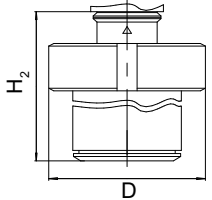

SMS connectors

SMS threaded sockets

DN	PN	∅D	H ₂
2"	25	70 x 1/6 mm (2.8")	Approx. 52 mm (2.1")
2½"	25	85 x 1/6 mm (3.3")	
3"	25	98 x 1/6 mm (3.9")	

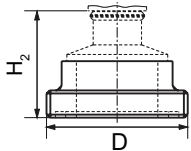

Remote operation

A.1 SIMATIC PDM

A.1.1 Overview SIMATIC PDM

SIMATIC PDM (Process Device Manager) is a general-purpose, manufacturer-independent tool for the configuration, parameter assignment, commissioning, diagnostics and maintenance of intelligent field devices and field components. Follow-up installations and additional information on SIMATIC PDM are available on the Internet at SIMATIC PDM (www.siemens.com/simatic-pdm).

SIMATIC PDM monitors the process values, alarms and status signals of the device. It allows you to display, compare, adjust, verify, and simulate process device data; also to set schedules for calibration and maintenance.

For information on, for example, how to install and integrate devices, commission the software, see Operating Manual 'Help for SIMATIC PDM'. The manual is delivered with SIMATIC PDM software. Once the SIMATIC PDM is installed on your computer you find the manual under: Start > All programs > Siemens Automation > SIMATIC > Documentation. Link at our website: SIMATIC PDM instructions and manuals (<https://support.industry.siemens.com/cs/ww/en/ps/16983/man>).

Note

Field device parameters

- For a list of parameters and additional information, consult section "Parameter assignment (Page 97)".
 - The field device remains in measurement mode during the time you configure the field device.
-

A.1.2 Check SIMATIC PDM version

Procedure

1. Go to SIMATIC PDM download (<http://www.siemens.com/simaticpdm/downloads>).
2. Check the support page to make sure you have:
 - The latest version of SIMATIC PDM
 - The most recent Service Pack (SP)
 - The most recent hot fix (HF)

A.1.3 Updating the Electronic Device Description (EDD)

Procedure

1. Check that the EDD revision match the Firmware revision in the device according to the table in section Product compatibility (Page 14).
2. Go to the support page Software downloads (<https://www.siemens.com/processinstrumentation/downloads>).
3. Enter the product name in the field "Enter search term...".
4. Download the most current EDD of your device.
5. Save files to your computer in an easily accessed location.
6. Launch SIMATIC PDM – Device Integration Manager.
From the File menu, click "Read device descriptions from compressed source...".
7. Browse to the zipped EDD file, select and open it.
8. Use the "Integration" function to integrate the EDD into the device catalog. The EDD is now accessible via SIMATIC Manager.

PROFIBUS communication

B.1 PROFIBUS assembly guidelines

Further information on the installation can be found on the Internet "PI PROFIBUS - PROFINET > DOWNLOADS (<https://www.profibus.com/download/>)" under "Installation Guide".

FOUNDATION Fieldbus communication

Device-specific information is described in the following sections.

More information on FOUNDATION Fieldbus and the FOUNDATION Fieldbus specifications is available on the Internet at:

FieldComm Group (<https://www.fieldcommgroup.org/>)

C.1 Resource Block

The Resource Block contains device-specific data. They include:

- Device type with change index
- Article number (MLFB number)
- Serial number
- Resource status

All data is designed as "integrated", and therefore there are no connections whatsoever to this block. Since the data cannot be processed as in a function block, there is no flowchart.

Note

Operating mode of resource block

The resource block must be in automatic mode so that the function blocks contained in the device can be executed.

The device contains all standard parameters according to FF-891 "Function Block Application Process".

The standard parameter "FEATURES" supports the following values:

- 1 Reports
- 2 Fault State
- 3 Soft Write
- 10 Multi-bit Alarm (Bit-Alarm)

C.2 Pressure Transducer Block

The Pressure Transducer Block contains all parameters to configure the device for the measuring task, e.g., characteristic curve.

In addition, the Pressure Transducer Block contains the following values:

- Sensor-specific information, such as material, type, remote seal type.
- Peak values
- Limit monitoring
- Simulation of the input and output values as constant pressure value or with ramp function.

C.3 Analog input function block

The Analog Input function block (AI function block) provides the measured values at its output for additional function blocks.

The device has three AI function blocks.

Each AI function block can be connected to one of the four channels of the Transducer Block:

- Pressure
- Sensor temperature
- Electronics temperature
- Derived process value (e.g., level)

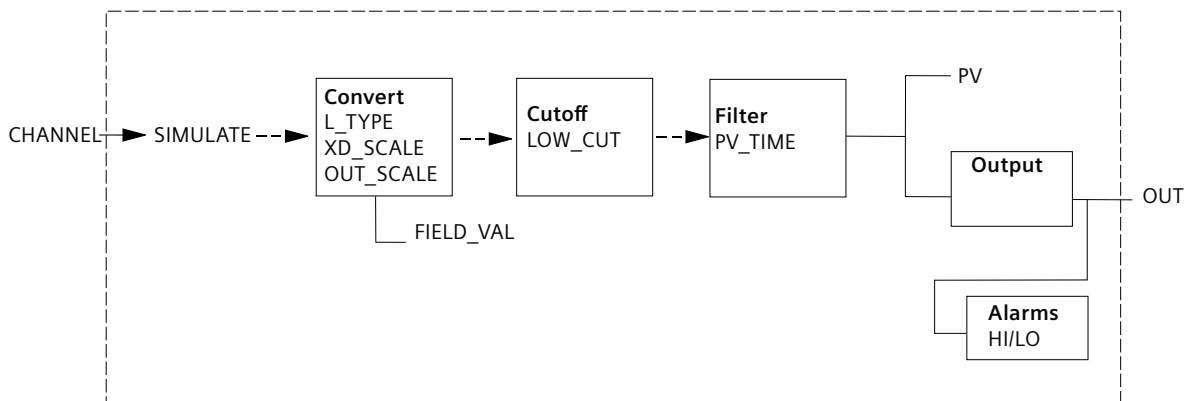

Figure C-1 Operating principle of the AI function block

Depending on the selected channel (CHANNEL), the input scaling values are set with the XD_SCALE parameter.

- Make sure that the settings under XD_SCALE match the settings (e.g., unit) in the Transducer Block.

You use the L_TYPE parameter to specify whether the process value (PV) is derived:

- Direct: The value from the Transducer Block is used directly.
- Indirect Linear: The value from the Transducer Block is scaled into different units.
- Indirect SQRT: The value from the Transducer Block is scaled and the square root extracted according to XD_SCALE and OUT_SCALE.

The output scaling values (OUT_SCALE) are usually applied from the Transducer Block.

You use the OUT_SCALE parameter to set the output scaling of the process value (PV).

The process value (PV) and the output value (OUT) have the same unit.

When the block is set to "Auto", OUT is equal to the PV.

With the LOW_CUT parameter, you set the low flow cut-off suppression (e.g., for volume flow measurement):

- When the output value is less than the value specified in this parameter, the output value is set to 0.
- You activate the low-cut function by setting the IO_OPTS parameter to "true".

You use the PV_FTIME parameter to set the time constant (damping) for the PV.

C.4 Proportional Integral Derivative (PID) Block

Functional principle

The PID function block implements a PID control algorithm. The execution time of the PID block is 16 ms. The input variable of the setpoint SP depends on the selected operating mode of the block.

Possible input variables are:

Operating mode	Input variable
AUTO	Parameter SP
CAS mode	Input CAS_IN
RCAS mode	Value RCAS_IN

In manual mode (MAN), the output OUT can be set directly to the desired value.

The process value to be controlled is connected to the input IN. This value passes through a filter with the time constant PV_FTIME.

A BYPASS switch is available to the operator for the case that the control option "Bypass enable" applies.

"Bypass" is used with secondary cascade controls (Cas) with a poor PV. The "Bypass enable" option is necessary because not all cascade control modes are stable when BYPASS is enabled.

The BYPASS parameter can only be set in "Manual" (Man) or "Out of Service" (OOS) modes. When BYPASS is set, the SP value (in percent of the range) is passed directly to the target output, and the OUT value is used for the BKCAL_OUT parameter.

When the mode is changed to "Cas", you must initialize the OUT value of the block in the "Open" direction. If you use a block in "Cas" mode, you must initialize the actual value (PV) in the "Open" direction when leaving the Bypass option. The initialization must be carried out independent of selection of the "Use PV for BKCAL_OUT" Option.

Controller constants

Controller constants for the P, I, and D factors are:

- GAIN: Dimensionless number
- RESET (adjustment time): Time constant expressed in seconds
- RATE (derivative-action time): Time constant expressed in seconds

A number of existing controllers are regulated by the inverse values of some or all of these time constants, e.g. proportional band and repetitions per minute.

If the RESET constant is set to "infinity", the integral component of the PID has no effect during normal operation. However, the integral component of the PID is still used internally to enable bumpless switchover from manual mode to automatic mode. The working point is adapted accordingly in automatic mode.

If RESET is set to "0 s", the integral component is set to zero. This results in a fixed working point.

The differential component defined by RATE is smoothed by a first order filter. This reduces the effects of the process noise. Without limitation by the cycle time, the time constant of the filter is $0.2 \cdot \text{RATE}$.

Control option "Direct action"

Note

Changing the setting of "Direct action"

Triggering of a positive or negative readback is possible depending on the setting. Therefore only change the setting of "Direct action" following careful checking. Never make changes to the selected setting during automatic mode.

If the actual value PV exceeds the setpoint SV, the setting of this control option results in an increase in the output value. A positive feedback is possible.

If the actual value PV exceeds the setpoint SV with the control option not set, the output value decreases. A negative feedback is possible.

The control option "Direct action" is additionally used to calculate the limit status for BKCAL_OUT.

Output

The output supports the feedforward algorithm. The input FF_VAL applies an external value which responds proportional to certain faults in the control loop. The value is converted by the values of the FF_SCALE parameter into a percentage of the output span.

This converted value is multiplied by the FF_GAIN parameter and added to the setpoint output of the PID algorithm.

If FF_VAL has a status Bad, the last usable value is applied in order to prevent jumps in the output. If FF_VAL returns to a good status, the block adapts its integral component in order to hold the previous output value.

The output supports the track algorithm.

The following values can be set as options for BKCAL_OUT:

- Setpoint SP following limiting
- Actual value

Flowchart

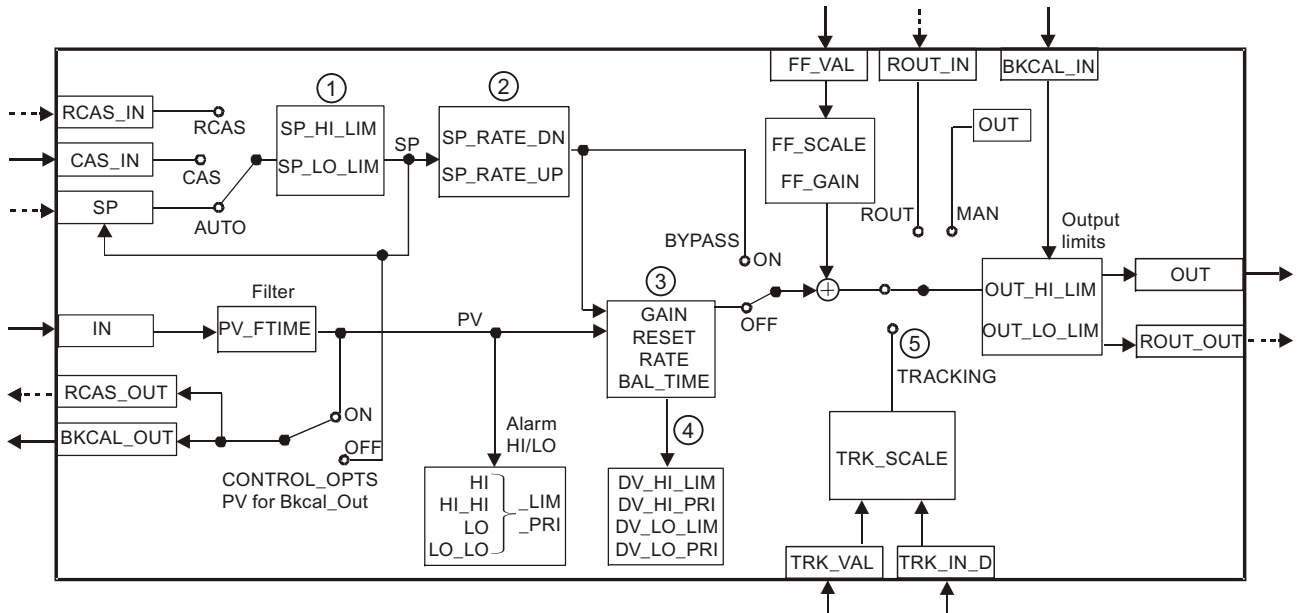

→ Inputs and outputs for connection

---→ Other inputs and outputs

PV Process value

SP Setpoint

① Setpoint limitation

② Manipulated variable limits

③ PLC

④ Deviation alarm

⑤ Tracking active if Track Enable = applicable, TRK_IN_D = applicable, and status of TRK_VAL and TRK_IN_D = good

Figure C-2 Flowchart of PID function block

Product documentation and support

D.1 Product documentation

Process instrumentation product documentation is available in the following formats:

- Certificates (<http://www.siemens.com/processinstrumentation/certificates>)
- Downloads (firmware, EDDs, software) (<http://www.siemens.com/processinstrumentation/downloads>)
- Catalog and catalog sheets (<http://www.siemens.com/processinstrumentation/catalogs>)
- Manuals (<http://www.siemens.com/processinstrumentation/documentation>)
You have the option to show, open, save, or configure the manual.
 - "Display": Open the manual in HTML5 format
 - "Configure": Register and configure the documentation specific to your plant
 - "Download": Open or save the manual in PDF format
 - "Download as html5, only PC": Open or save the manual in the HTML5 view on your PC

You can also find manuals with the Mobile app at Industry Online Support (<https://support.industry.siemens.com/cs/ww/de/sc/2067>). Download the app to your mobile device and scan the device QR code.

Product documentation by serial number

Using the PIA Life Cycle Portal, you can access the serial number-specific product information including technical specifications, spare parts, calibration data, or factory certificates.

Entering a serial number

1. Open the PIA Life Cycle Portal (<https://www.pia-portal.automation.siemens.com>).
2. Select the desired language.
3. Enter the serial number of your device. The product documentation relevant for your device is displayed and can be downloaded.

To display factory certificates, if available, log in to the PIA Life Cycle Portal using your login or register.

Scanning a QR code

1. Scan the QR code on your device with a mobile device.
2. Click "PIA Portal".

To display factory certificates, if available, log in to the PIA Life Cycle Portal using your login or register.

D.2 Technical support

Technical support

If this documentation does not completely answer your technical questions, you can enter a Support Request (<http://www.siemens.com/automation/support-request>).

Additional information on our technical support can be found at Technical Support (<http://www.siemens.com/automation/csi/service>).

Service & support on the Internet

In addition to our technical support, Siemens offers comprehensive online services at Service & Support (<http://www.siemens.com/automation/serviceandsupport>).

Contact

If you have further questions about the device, contact your local Siemens representative at Personal Contact (<http://www.automation.siemens.com/partner>).

To find the contact for your product, go to "all products and branches" and select "Products & Services > Industrial automation > Process instrumentation".

Contact address for business unit:

Siemens AG
Digital Industries
Process Automation
Östliche Rheinbrückenstr. 50
76187 Karlsruhe, Germany

Sealing plug / thread adapter

E.1 Intended use of accessory part

The sealing plug and the thread adapter (components) can be used for installation in electrical equipment of flameproof "Ex d" type of protection of groups IIA, IIB, IIC as well as dust protection by enclosure "Ex t" type of protection.

E.2 Safety instructions for accessory part

<p> WARNING</p> <p>Incorrect assembly</p> <ul style="list-style-type: none"> The component can be damaged or destroyed or its functionality impaired through incorrect assembly. <ul style="list-style-type: none"> Mount the component using a suitable tool. Refer to the information in Chapter "Technical specifications of accessory part (Page 236)", for example, torques for installation. For "Explosion-proof Ex d" type of protection: To ensure an engagement depth of 8 mm, the enclosure must have a wall thickness of at least 10 mm. <p>Improper modifications</p> <p>Danger to personnel, system and environment can result from modifications and repairs of the component, particularly in hazardous areas.</p> <ul style="list-style-type: none"> Any modification which deviates from the delivery state is not permitted. <p>Loss of enclosure type of protection</p> <p>IP protection is not guaranteed without sealant.</p> <ul style="list-style-type: none"> Use a suitable thread sealant. If you are using the component in type of protection dust protection by enclosure "Ex t", use the supplied sealing ring (①, figure in Chapter "Dimensional drawings for accessory part (Page 237)"). <p>Unsuitable fluids in the environment</p> <p>Danger of injury or damage to device.</p> <p>Aggressive media in the environment can damage the sealing ring. Type of protection and device protection may no longer be guaranteed.</p> <ul style="list-style-type: none"> Make sure that the sealing material is suitable for the area of use.

Note**Loss of type of protection**

Changes in the ambient conditions can loosen the component.

- As part of the recommended maintenance intervals: Check the compression fitting for tight fit and tighten, if necessary.

E.3 Technical specifications of accessory part

Technical specifications sealing plug and thread adapter	
Sealing plug suitable for types of protection	Explosion-proof enclosure "db" of groups IIA, IIB, IIC Dust protection by enclosure "ta"
Standard compliance	The components meet Directive 2014/34/EU. They meet the requirements of standards IEC/EN 60079-0; IEC/EN 60079-1; IEC/EN 60079-31.
Explosion protection	
• Gas explosion protection	II2G Ex db IIC Gb
• Dust explosion protection	II1D Ex ta IIIC Da
Certificates	IECEX TUN 13.0022 U TÜV 13 ATEX 121710 U
Material for sealing plug / thread adapter	Stainless steel
Material for seal	AFM 30
Ambient temperature range	-40 ... +100 °C (-40 ... +212 °F)
For "Ex d" type of protection:	
Required wall thickness for tappings	10 mm
Torque	
• For thread size M20 x 1.5	40 Nm
• For thread size M25 x 1.5	55 Nm
• For thread size ½-14 NPT	95 Nm
Width A/F for thread size M20 x 1.5	27
Width A/F for thread size M25 x 1.5	30
Key size for thread size ½-14 NPT	10

E.4 Dimensional drawings for accessory part

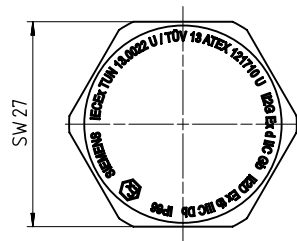
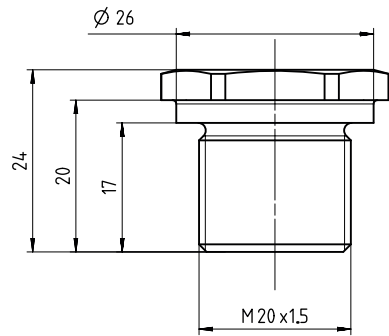

Sealing plug Ex d, M20 x 1.5, dimensions in mm

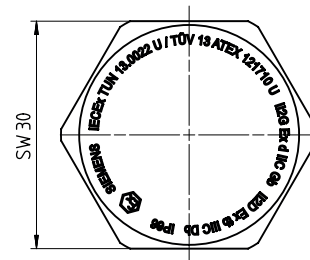
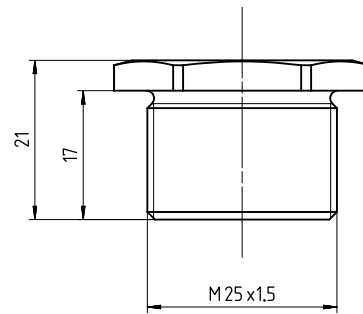

Sealing plug Ex d, M25 x 1.5, dimensions in mm

E.4 Dimensional drawings for accessory part

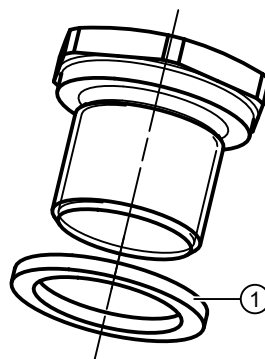
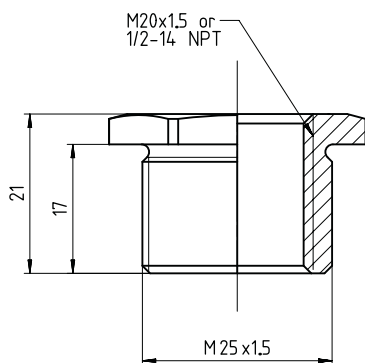

① Sealing ring: Use for dust protection "Ex t" type of protection.

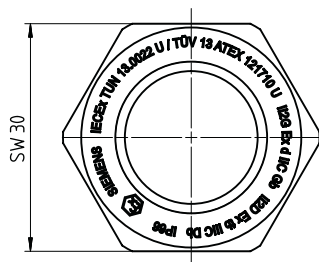

Thread adapter Ex d, M25 x 1.5 on M20 x 1.5 and M25 x 1.5 on 1/2-14 NPT, dimensions in mm

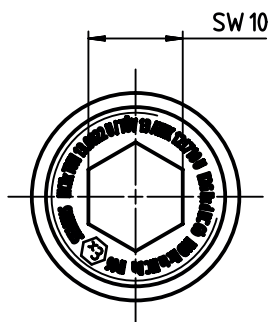
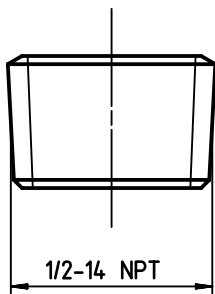

Sealing plug Ex d 1/2 -14 NPT

Abbreviations

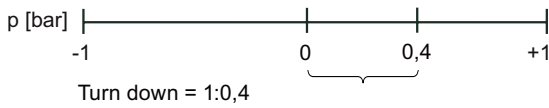
Abbreviation	In full	Meaning
PED	Pressure Equipment Directive	
GSD	General Station Description	Electronically readable ASCII text file which contains both general and device-specific parameters for communication and network configuration.
HART	Highway Addressable Remote Transducer	Standardized protocol for transmission of information between field device and automation system.
LRL	Lower Range Limit	Lower end of the measuring range
LRV	Lower Range Value	Lower end of the set measuring span
MA	Lower range value	Lower end of the set measuring span
ME	Upper range value	Upper end of the set measuring span
MAWP	Maximum Allowable Working Pressure (PS)	Maximum permissible operating pressure
NFPA	National Fire Protection Association	US - American Fire Protection Organization
F&B	Food and beverage industry	
<i>r</i>	Turndown	<p>Ratio of the set measuring span to the maximum set measuring span, for example</p>  <p>Set measuring span: 0.4 bar Maximum configured measuring span: 1 bar</p>
URL	Upper Range Limit	Upper end of the measuring range
URV	Upper Range Value	Upper end of the set measuring span

Index

3

3A, 217

A

ACTIVE GSD, 79
Aluminum enclosure, 60
Ambient temperature, 193, 194, 196, 197
 Effect, 177, 187
Application, 101
APPLICATION, 78
Approval
 3A, 217
 EHEDG, 217

B

Blowout valve, 89
Blowout valves, 91
Bridge output voltage, 31, 36, 37
BUTTON LOCK, 79

C

Cable gland
 Installing, 58
Catalog
 catalog sheets, 233
Certificates, 17, 233
CHG USER PIN, 79
Cleaning, 144
CONFIG COUNT, 79
CONIC, 108
CUSTM, 108
Customer Support, (Refer to Technical support)
CYLIN, 108

D

DAMPING, 78
Device plug
 Installing, 58
Diagnostic messages, 153
Differential pressure, 24
Direct sunlight, 42

Disassembly, 63
DISPLAY TEST, 79
Document history, 13
Downloads, 233

E

Edit view, 80
EHEDG, 217
Electromagnetic compatibility, 194, 195, 196, 197
EMC, 194, 195, 196, 197

F

FEATURES, 227
Filling liquid, 31, 35, 37
Flange, 48
FLAT, 108
Function chart, 33
FW VERSION, 79

G

GSD SELECT, 79

H

HALF, 108
Hazardous area
 Laws and directives, 17
 Qualified personnel, 19
Hotline, (Refer to Support request)
Hygienic version
 Install, 47

I

Identification data
 define, 131
In accordance with the square root function
 see square-root extraction, 104
Install
 Remote seal, 51
Insulation, 45
internal overvoltage protection up to 6 kV, 204

J

Jumper, 61, (See Jumper)

L

Laws and directives
 Disassembly, 17
 Personel, 17
Layout of nameplate with general information, 26
Level, 24
LEVEL, 108
LEVEL UNITS, 78
LOW FLOW CUT, 79
Low flow cut-off, 104, 117
LOW IN SCALE, 78
LOWER SCALNG, 79

M

Maintenance, 143
Manuals, 233
MAWP, 239
Measurement view, 76
Measuring cell
 Absolute pressure, 33
 Differential pressure and flow, 36
 Gauge pressure, 31
 Level, 37
Measuring point, 28
MFLOW UNITS, 78
Modifications
 correct usage, 18
 improper, 18
Mounting bracket
 Install, 45
Mounting flange, 37
MSLN, 108
MSLN2, 108
MSOFF, 108
MWP, (See MAWP)

N

Nameplate, 26

O

Order supplement, 26

Output signal, 23, 29

P

PARAB, 108
PARAE, 108
Parameter view, 78
PIN RECOVERY, 79
Position of the enclosure, 60
PRESS, 108
PRESS UNITS, 78
PRESSURE REF, 79
Pressure reference, 97
Pressure units, 97

Q

QR code, 26
Qualified personnel, 19

R

Recovery ID, 121
RECOVERY ID, 79
Remote seal
 Install, 51
 Maintenance, 144
RESET, 79
Return procedure, 149

S

Scope of delivery, 14
Sealing plug
 Technical specifications, 236
Sealing plugs
 Installing, 58
Sensor calibration, 135
Serial number, 27
Service, 234
Service and support
 Internet, 234
Shut-off valve, 90, 91, 93, 95
SLAVE ADDR, 79
SPHER, 108
SQRT POINT, 78
Square root function
 Hold at 0, square root, 104
 Linear, square root, 104
 Two step linear, square root, 104

Stabilizing valve, 91, 92, 93, 95
Stainless steel enclosure, 61
START VIEW, 79
Startup parameters, 128
Structure, 25
Support, 234
Support request, 234

T

Tank connection, 221
Technical support, 234
 partner, 234
 personal contact, 234
TEMP UNITS, 78
Test certificates, 17
Threaded adapter
 Technical specifications, 236
Torque, 236
Torques, 203
Transfer function, (See Application)
Turndown, 239

U

UP IN SCALE, 78
UPPER SCALNG, 79
User PIN, 123
 Factory setting, 120
USER PIN, 79

V

Vent valve, 93, 95
VESSEL DIM A, 79
VESSEL DIM L, 79
VFLOW UNITS, 78
VLIN, 108
VOL UNITS, 78
VSLN, 108
VSLN2, 108
VSOFF, 108

W

Warranty, 15
Write protection, 81, 82
 Jumper, 82

Z

ZERO POINT, 78

