

SIEMENS

SITRANS L

Radar transmitters SITRANS LR560 with Foundation Fieldbus

Operating Instructions

<u>Introduction</u>	1
<u>Safety notes</u>	2
<u>Description</u>	3
<u>Installing/mounting</u>	4
<u>Connecting</u>	5
<u>Commissioning</u>	6
<u>Operating</u>	7
<u>Parameter Reference</u>	8
<u>Service and maintenance</u>	9
<u>Diagnosing and troubleshooting</u>	10
<u>Technical data</u>	11
<u>Dimension drawings</u>	12
<u>Technical reference</u>	A
<u>Certificates and Support</u>	B
<u>HMI menu structure</u>	C
<u>List of abbreviations</u>	D

Legal information

Warning notice system

This manual contains notices you have to observe in order to ensure your personal safety, as well as to prevent damage to property. The notices referring to your personal safety are highlighted in the manual by a safety alert symbol, notices referring only to property damage have no safety alert symbol. These notices shown below are graded according to the degree of danger.

⚠ DANGER
indicates that death or severe personal injury will result if proper precautions are not taken.
⚠ WARNING
indicates that death or severe personal injury may result if proper precautions are not taken.
⚠ CAUTION
indicates that minor personal injury can result if proper precautions are not taken.
NOTICE
indicates that property damage can result if proper precautions are not taken.

If more than one degree of danger is present, the warning notice representing the highest degree of danger will be used. A notice warning of injury to persons with a safety alert symbol may also include a warning relating to property damage.

Qualified Personnel

The product/system described in this documentation may be operated only by **personnel qualified** for the specific task in accordance with the relevant documentation, in particular its warning notices and safety instructions. Qualified personnel are those who, based on their training and experience, are capable of identifying risks and avoiding potential hazards when working with these products/systems.

Proper use of Siemens products

Note the following:

⚠ WARNING
Siemens products may only be used for the applications described in the catalog and in the relevant technical documentation. If products and components from other manufacturers are used, these must be recommended or approved by Siemens. Proper transport, storage, installation, assembly, commissioning, operation and maintenance are required to ensure that the products operate safely and without any problems. The permissible ambient conditions must be complied with. The information in the relevant documentation must be observed.

Trademarks

All names identified by ® are registered trademarks of Siemens AG. The remaining trademarks in this publication may be trademarks whose use by third parties for their own purposes could violate the rights of the owner.

Disclaimer of Liability

We have reviewed the contents of this publication to ensure consistency with the hardware and software described. Since variance cannot be precluded entirely, we cannot guarantee full consistency. However, the information in this publication is reviewed regularly and any necessary corrections are included in subsequent editions.

Table of contents

1	Introduction.....	10
1.1	Purpose of this documentation	10
1.2	Security information	10
1.3	Checking the consignment	11
1.4	Transportation and storage.....	11
1.5	Notes on warranty.....	11
1.6	Firmware revision history.....	12
2	Safety notes.....	13
2.1	Preconditions for use	13
2.1.1	Improper device modifications	13
2.1.2	Laws and directives	13
2.1.3	Safety marking symbols.....	14
2.1.4	Conformity with European directives	14
2.1.5	Radio Equipment Directive (RED) compliance (Europe).....	15
2.1.6	Federal Communications Commission (FCC) conformity (US).....	15
2.1.7	Industry Canada.....	16
2.2	Use in hazardous areas.....	16
2.3	Requirements for special applications	17
3	Description.....	18
3.1	SITRANS LR560 overview	18
4	Installing/mounting.....	19
4.1	Basic safety instructions	19
4.1.1	Installation location requirements	20
4.1.2	Proper mounting	21
4.1.2.1	Incorrect mounting	21
4.2	Installation instructions	22
4.2.1	Pressure equipment directive (PED, 2014/68/EU)	22
4.2.2	Nozzle location.....	23
4.2.3	Environment.....	24
4.2.4	Sunshield	24
4.2.5	Aimer adjustment.....	25
4.2.6	Air purging system	26
4.2.7	Removable display.....	27
4.3	Disassembly.....	27
4.3.1	Incorrect disassembly	27
5	Connecting	28
5.1	Basic safety information.....	28

5.1.1	Incorrect connection to power source	29
5.2	Connecting SITRANS LR560.....	30
5.3	Configuration diagrams.....	31
5.3.1	Basic configurations.....	31
5.3.1.1	Configuration via PCI/PCMCIA card.....	31
5.3.1.2	Configuration via linking device	32
5.3.2	Hazardous area configurations.....	32
5.3.2.1	Configuration via PCI/PCMCIA card.....	32
5.3.2.2	Configuration via Gateway and linking device.....	33
5.4	Nameplates for hazardous area installations.....	33
5.4.1	FOUNDATION FIELDBUS Non-Sparking/Energy Limited wiring (Europe) and Dust Ignition Proof wiring (Europe/International)	34
5.4.2	FM/CSA Class 1, Div 2 installation and connection drawing.....	34
5.5	Instructions specific to hazardous area installations.....	34
5.5.1	(Reference European ATEX Directive 2014/34/EU, Annex II, 1.0.6)	34
5.5.2	Special conditions for safe use	35
6	Commissioning	36
6.1	Basic safety notes.....	36
6.2	Activating the radar device.....	38
6.3	The LCD display.....	38
6.4	Commissioning via local display	40
6.4.1	Local operation.....	40
6.4.2	Quick Start Wizard via the local display push buttons.....	40
6.5	Commissioning via handheld programmer	41
6.5.1	Handheld programmer (Part No. 7ML1930-1BK)	41
6.5.2	Hand programmer_note	41
6.5.3	Lithium batteries.....	42
6.5.4	Key functions in measurement mode	43
6.5.5	Programming.....	44
6.5.5.1	Programming the radar device.....	44
6.5.5.2	Parameter menus_FF	44
6.5.5.3	Parameter menus.....	45
6.5.5.4	Quick Start Wizard via the handheld programmer	48
6.5.5.5	Requesting an Echo Profile	52
6.6	Device Address.....	52
6.7	Application example.....	53
7	Operating.....	54
7.1	Remote operation.....	54
7.1.1	Operating via AMS Device Manager.....	54
7.1.1.1	Functions in AMS Device Manager.....	54
7.1.1.2	Programming via AMS Device Manager.....	56
7.1.1.3	Adding a new device.....	57
7.1.1.4	Configuring a new device.....	60
7.1.1.5	Changing block modes	64
7.1.1.6	Configure/Setup parameters.....	65

7.1.1.7	Password protection	95
7.1.1.8	AMS menu structure	97
8	Parameter Reference	108
8.1	QUICK START (1.)	108
8.1.1	QUICK START WIZARD (1.1.)	108
8.1.2	AFES WIZARD (1.2.)	109
8.1.3	COPY PARAMETERS TO DISPLAY (1.3.)	110
8.1.4	COPY PARAMETERS FROM DISPLAY (1.4)	110
8.1.5	COPY FIRMWARE TO DISPLAY (1.5.)	111
8.1.6	COPY FIRMWARE FROM DISPLAY (1.6.)	111
8.2	SETUP (2.)	111
8.2.1	IDENTIFICATION (2.1.)	112
8.2.1.1	TAG (2.1.1.)	112
8.2.1.2	DESCRIPTOR (2.1.2.)	112
8.2.1.3	MESSAGE (2.1.3.)	112
8.2.1.4	INSTALLATION DATE (2.1.4.)	112
8.2.2	DEVICE (2.2.)	112
8.2.2.1	HARDWARE REVISION (2.2.1.)	112
8.2.2.2	FIRMWARE REVISION (2.2.2.)	112
8.2.2.3	LOADER REVISION (2.2.3.)	112
8.2.2.4	MANUFACTURE DATE (2.2.4.)	112
8.2.3	SENSOR (2.3.)	113
8.2.3.1	UNIT (2.3.1.)	113
8.2.3.2	LEVEL UNIT (2.3.2.)	113
8.2.3.3	TEMPERATURE UNITS (2.3.3.)	113
8.2.3.4	LOE TIMER (2.3.4.)	114
8.2.3.5	CALIBRATION (2.3.5.)	114
8.2.3.6	RATE (2.3.6.)	116
8.2.4	SIGNAL PROCESSING (2.4.)	117
8.2.4.1	NEAR RANGE (2.4.1.)	117
8.2.4.2	FAR RANGE (2.4.2.)	118
8.2.4.3	MINIMUM SENSOR VALUE (2.4.3.)	118
8.2.4.4	MAXIMUM SENSOR VALUE (2.4.4.)	119
8.2.4.5	ECHO SELECT (2.4.5.)	119
8.2.4.6	SAMPLING (2.4.6.)	121
8.2.4.7	ECHO LOCK (2.4.6.1.)	121
8.2.4.8	UP SAMPLING (2.4.6.2.)	121
8.2.4.9	DOWN SAMPLING (2.4.6.3.)	121
8.2.4.10	ECHO LOCK WINDOW (2.4.6.4.)	122
8.2.4.11	ECHO QUALITY (2.4.7.)	122
8.2.4.12	TVT SETUP (2.4.8.)	123
8.2.4.13	AUTO ECHO SUPPRESSION (2.4.8.1.)	123
8.2.4.14	AUTO SUPPRESSION RANGE (2.4.8.2.)	125
8.2.4.15	HOVER LEVEL (2.4.8.3.)	125
8.2.4.16	SHAPER MODE (2.4.8.4.)	125
8.2.4.17	TVT SHAPER (2.4.9.)	125
8.2.5	AIFB1 (2.5.)	126
8.2.5.1	STATIC REVISION NO. (2.5.1.)	126
8.2.5.2	MODE (2.5.2.)	127
8.2.5.3	CHANNEL (2.5.3.)	127
8.2.5.4	INPUT SCALING (2.5.4.)	128

8.2.5.5	OUTPUT SCALING (2.5.5.)	129
8.2.5.6	HI LIMIT ALARM (2.5.6.1.)	129
8.2.5.7	HI LIMIT WARNING (2.5.6.2.)	129
8.2.5.8	LO LIMIT WARNING (2.5.6.3.)	130
8.2.5.9	LO LIMIT ALARM (2.5.6.4.)	130
8.2.5.10	LIMIT HYSTERESIS (2.5.6.5.)	130
8.2.5.11	FILTER TIME CONSTANT (2.5.7.1.)	130
8.2.6	AIFB 2 (2.6.)	130
8.2.7	MEASURED VALUES (2.7.)	131
8.2.8	MAIN OUTPUT (2.7.1.)	131
8.2.9	OUTPUT NO LINEARIZATION (2.7.2.)	131
8.2.10	OUTPUT NO OFFSETS (2.7.3.)	131
8.2.11	NARROW ECHO FILTER (2.8.1.)	131
8.2.12	REFORM ECHO (2.8.2.)	131
8.2.13	AVERAGE AMOUNT (2.8.3.)	131
8.3	DIAGNOSTICS (3.)	132
8.3.1	ECHO PROFILE (3.1.)	132
8.3.2	FAULT RESET (3.2.)	133
8.3.3	TREND (3.3.)	133
8.3.4	ELECTRONICS TEMPERATURE (3.4.)	133
8.3.5	MINIMUM VALUE (3.4.1.)	133
8.3.6	MAXIMUM VALUE (3.4.2.)	133
8.3.7	PEAK VALUES (3.5.)	134
8.3.7.1	MINIMUM MEASURED VALUE (3.5.1.)	134
8.3.7.2	MAXIMUM MEASURED VALUE (3.5.2.)	134
8.4	SERVICE (4.)	134
8.4.1	MASTER RESET (4.1.)	134
8.4.2	REMAINING DEVICE LIFETIME (4.2.)	135
8.4.2.1	LIFETIME EXPECTED (4.2.1.)	135
8.4.2.2	TIME IN OPERATION (4.2.2.)	136
8.4.2.3	REMAINING LIFETIME (4.2.3.)	136
8.4.2.4	REMINDER ACTIVATION (4.2.4.)	136
8.4.2.5	REMINDER 1 (REQUIRED) (4.2.5.)	136
8.4.2.6	REMINDER 2 (DEMANDED) (4.2.6.)	136
8.4.2.7	MAINTENANCE STATUS (4.2.7.)	136
8.4.2.8	ACKNOWLEDGE STATUS (4.2.8.)	137
8.4.2.9	ACKNOWLEDGE (4.2.9.)	137
8.4.3	REMAINING SENSOR LIFETIME (4.3.)	137
8.4.3.1	LIFETIME EXPECTED (4.3.1.)	137
8.4.3.2	TIME IN OPERATION (4.3.2.)	137
8.4.3.3	REMAINING LIFETIME (4.3.3.)	138
8.4.3.4	REMINDER ACTIVATION (4.3.4.)	138
8.4.3.5	REMINDER 1 (REQUIRED) (4.3.5.)	138
8.4.3.6	REMINDER 2 (DEMANDED) (4.3.6.)	138
8.4.3.7	MAINTENANCE STATUS (4.3.7.)	138
8.4.3.8	ACKNOWLEDGE STATUS (4.3.8.)	139
8.4.3.9	ACKNOWLEDGE (4.3.9.)	139
8.4.4	SERVICE SCHEDULE (4.4.)	139
8.4.4.1	SERVICE INTERVAL (4.4.1.)	139
8.4.4.2	TIME SINCE LAST SERVICE (4.4.2.)	139
8.4.4.3	TIME UNTIL NEXT SERVICE (4.4.3.)	140

8.4.4.4	REMINDER ACTIVATION (4.4.4.).....	140
8.4.4.5	REMINDER 1 (REQUIRED) (4.4.5.).....	140
8.4.4.6	REMINDER 2 (DEMANDED) (4.4.6.).....	140
8.4.4.7	MAINTENANCE STATUS (4.4.7.).....	140
8.4.4.8	ACKNOWLEDGE STATUS (4.4.8.).....	141
8.4.4.9	ACKNOWLEDGE (4.4.9.).....	141
8.4.5	CALIBRATION SCHEDULE (4.5.).....	141
8.4.5.1	CALIBRATION INTERVAL (4.5.1.).....	141
8.4.5.2	TIME SINCE LAST CALIBRATION (4.5.2.).....	141
8.4.5.3	TIME UNTIL NEXT CALIBRATION (4.5.3.).....	142
8.4.5.4	REMINDER ACTIVATION (4.5.4.).....	142
8.4.5.5	REMINDER 1 (REQUIRED) (4.5.5.).....	142
8.4.5.6	REMINDER 2 (DEMANDED) (4.5.6.).....	142
8.4.5.7	MAINTENANCE STATUS (4.5.7.).....	142
8.4.5.8	ACKNOWLEDGE STATUS (4.5.8.).....	143
8.4.5.9	ACKNOWLEDGE (4.5.9.).....	143
8.4.6	POWERED HOURS (4.6.).....	143
8.4.7	POWERON RESETS (4.7.).....	143
8.4.8	MENU TIMEOUT (4.8.).....	143
8.4.9	LCD BACKLIGHT (4.9.).....	143
8.4.10	LCD CONTRAST (4.10.).....	144
8.4.11	SECONDARY VALUE (4.11.).....	144
8.4.12	SIMULATE ENABLE (4.12.).....	144
8.4.13	DEMO MODE (4.13.).....	144
8.4.14	STORED SOFTWARE VERSION (4.14.).....	144
8.5	COMMUNICATION (5.).....	145
8.5.1	TAG (5.1.).....	145
8.5.2	DEVICE ADDRESS (5.2.).....	145
8.5.3	MANUFACTURER (5.3.).....	145
8.5.4	DEVICE TYPE ID (5.4.).....	145
8.5.5	DEVICE REVISION (5.5.).....	145
8.5.6	ITK VERSION (5.6.).....	145
8.6	SECURITY (6.).....	146
8.6.1	REMOTE LOCKOUT (6.1.1.).....	146
8.6.2	WRITE PROTECT (6.2.1.).....	146
8.6.3	LOCAL OPERATION (6.2.2.).....	146
8.7	LANGUAGE (7.).....	147
9	Service and maintenance	148
9.1	Basic safety notes.....	148
9.1.1	Maintenance	148
9.2	Cleaning.....	149
9.3	Maintenance and repair work	149
9.4	Return procedure.....	152
9.5	Disposal	153
10	Diagnosing and troubleshooting	154
10.1	Device status icons.....	154

10.2	General fault codes.....	155
10.3	Operation troubleshooting.....	158
10.4	Communication Troubleshooting	159
11	Technical data	160
11.1	Power	160
11.2	Performance.....	160
11.3	Construction	161
11.4	Operating conditions	161
11.5	Process	162
11.6	Approvals data	163
11.7	Communication: Foundation Fieldbus	163
11.8	Programmer (infrared keypad).....	164
12	Dimension drawings	165
12.1	SITRANS LR560 with stainless steel universal flat-faced flange	165
12.2	SITRANS LR560 with 3" aimer flange	166
12.3	SITRANS LR560 with 4" and 6" aimer flange.....	167
12.4	SITRANS LR560 with stamped flange.....	168
12.5	Universal slotted flange.....	169
12.6	Stamped flange	171
12.7	Process connection label (pressure rated versions).....	172
A	Technical reference	173
A.1	Principles of operation	173
A.2	Process variables.....	173
A.3	Echo processing.....	173
A.3.1	Process Intelligence.....	173
A.3.2	Echo selection.....	174
A.3.3	CLEF RANGE (2.4.5.4.).....	176
A.3.4	ECHO THRESHOLD (2.4.5.3.)	176
A.3.5	ECHO LOCK (2.4.6.1.)	176
A.3.6	AUTO FALSE ECHO SUPPRESSION (2.4.8.1.).....	177
A.4	Measurement range.....	179
A.5	Measurement response	179
A.6	Damping.....	180
A.7	Loss of Echo (LOE).....	180
A.8	Temperature De-Rating	181
A.9	Temperature derating curve.....	181
B	Certificates and Support	182

B.1	Technical support.....	182
B.2	QR code label	182
B.3	Certificates	183
C	HMI menu structure	184
C.1	HMI menu	184
D	List of abbreviations.....	190
D.1	List of abbreviations	190
	Glossary	191
	Index.....	196

Introduction

Note

This manual applies to the SITRANS LR560 (FOUNDATION FIELDBUS) version only.

1.1 Purpose of this documentation

These instructions contain all information required to commission and use the device. Read the instructions carefully prior to installation and commissioning. In order to use the device correctly, first review its principle of operation.

The instructions are aimed at persons mechanically installing the device, connecting it electronically, configuring the parameters and commissioning it, as well as service and maintenance engineers.

1.2 Security information

Siemens provides products and solutions with industrial security functions that support the secure operation of plants, systems, machines and networks.

In order to protect plants, systems, machines and networks against cyber threats, it is necessary to implement – and continuously maintain – a holistic, state-of-the-art industrial security concept. Siemens' products and solutions constitute one element of such a concept.

Customers are responsible for preventing unauthorized access to their plants, systems, machines and networks. Such systems, machines and components should only be connected to an enterprise network or the internet if and to the extent such a connection is necessary and only when appropriate security measures (e.g. firewalls and/or network segmentation) are in place.

For additional information on industrial security measures that may be implemented, please visit
<https://www.siemens.com/industrialsecurity>.

Siemens' products and solutions undergo continuous development to make them more secure. Siemens strongly recommends that product updates are applied as soon as they are available and that the latest product versions are used. Use of product versions that are no longer supported, and failure to apply the latest updates may increase customer's exposure to cyber threats.

To stay informed about product updates, subscribe to the Siemens Industrial Security RSS Feed under
<https://www.siemens.com/industrialsecurity>.

1.3 Checking the consignment

1. Check the packaging and the delivered items for visible damages.
2. Report any claims for damages immediately to the shipping company.
3. Retain damaged parts for clarification.
4. Check the scope of delivery by comparing your order to the shipping documents for correctness and completeness.

 WARNING
Using a damaged or incomplete device
Risk of explosion in hazardous areas.
<ul style="list-style-type: none">• Do not use damaged or incomplete devices.

1.4 Transportation and storage

To guarantee sufficient protection during transport and storage, observe the following:

- Keep the original packaging for subsequent transportation.
- Devices/replacement parts should be returned in their original packaging.
- If the original packaging is no longer available, ensure that all shipments are properly packaged to provide sufficient protection during transport. Siemens cannot assume liability for any costs associated with transportation damages.

NOTICE
Insufficient protection during storage
The packaging only provides limited protection against moisture and infiltration.
<ul style="list-style-type: none">• Provide additional packaging as necessary.

Special conditions for storage and transportation of the device are listed in Technical reference (Page 173).

1.5 Notes on warranty

The contents of this manual shall not become part of or modify any prior or existing agreement, commitment or legal relationship. The sales contract contains all obligations on the part of Siemens as well as the complete and solely applicable warranty conditions. Any statements regarding device versions described in the manual do not create new warranties or modify the existing warranty.

The content reflects the technical status at the time of publishing. Siemens reserves the right to make technical changes in the course of further development.

1.6 Firmware revision history

Firmware version	Hardware version	EDD version	Date (dd/mm/yyyy)	Changes
1.00.00	1.00.00	1.00.00	21 June 2010	Initial release
1.0002-08	1.xx.xx	1.00.02-06	14 February 2012	<ul style="list-style-type: none">• Additional diagnostics added during startup• Min. and max. temp. parameter no longer editable• factory automated test improvements
1.00.02-10	1.xx.xx	1.00.02-32	16 March 2012	Maintenance release
1.00.04-06	2.xx.xx	1.xx.xx	Dec 2018	Maintenance release

Note

Damage to the electronic module

On devices with hardware version 2.00.00 or subsequent versions, do not downgrade the firmware to any versions before 1.00.04-06. The electronic module will be damaged. New firmware versions are back compatible with older versions of the hardware; however, devices with new hardware versions are not compatible with older firmware versions.

Safety notes

2.1 Preconditions for use

This device left the factory in good working condition. In order to maintain this status and to ensure safe operation of the device, observe these instructions and all the specifications relevant to safety.

Observe the information and symbols on the device. Do not remove any information or symbols from the device. Always keep the information and symbols in a completely legible state.

2.1.1 Improper device modifications

 WARNING
Improper device modifications Risk to personnel, system and environment can result from modifications to the device, particularly in hazardous areas. <ul style="list-style-type: none">• Only carry out modifications that are described in the instructions for the device. Failure to observe this requirement cancels the manufacturer's warranty and the product approvals.

2.1.2 Laws and directives



Observe the safety rules, provisions and laws applicable in your country during connection, assembly and operation. These include, for example:

- National Electrical Code (NEC - NFPA 70) (USA)
- Canadian Electrical Code (CEC) (Canada)

Further provisions for hazardous area applications are for example:

- IEC 60079-14 (international)
- EN 60079-14 (EU)

2.1.3 Safety marking symbols

In manual	On product	Description
	 (Label on product: yellow back- ground.)	WARNING: refer to accompanying documents (manual) for details.

2.1.4 Conformity with European directives

The CE marking on the device symbolizes the conformity with the following European directives:

Electromagnetic compatibility EMC 2014/30/EU	Directive of the European Parliament and of the Council on the harmonisation of the laws of the Member States relating to electromagnetic compatibility
Low voltage directive LVD 2014/35/EU	Directive of the European Parliament and of the Council on the harmonisation of the laws of the Member States relating to the making available on the market of electrical equipment designed for use within certain voltage limits
Atmosphère explosible ATEX 2014/34/EU	Directive of the European Parliament and the Council on the harmonisation of the laws of the Member States relating to equipment and protective systems intended for use in potentially explosive atmospheres
Pressure equipment directive PED 2014/68/EU	Directive of the European Parliament and of the Council on the harmonisation of the laws of the Member States relating to the making available on the market of pressure equipment
RED 2014/53/EU	Directive of the European Parliament and of the Council on the harmonisation of the laws of the Member States relating to the making available on the market of radio equipment and repealing Directive 1999/5/EC

The applicable directives can be found in the EC conformity declaration of the specific device.

2.1.5 Radio Equipment Directive (RED) compliance (Europe)

Hereby, Siemens declares that the SITRANS LR560 is in compliance with the essential requirements and other relevant provisions of Directive 2014/53/EU.

The LR560 complies with EN 302 372 for use in closed storage vessels, when installed according to the installation requirements of EN 302 372, and may be used in all EU countries.

For the receiver test that covers the influence of an interferer signal to the device, the performance criterion has at least the following level of performance according to ETSI TS 103 361 [6]:

- Performance criterion: measurement value variation Δd over time during a distance measurement
- Level of performance: $\Delta d \leq \pm 50$ mm

The LR560 complies with ETSI EN 302 729 for use outside of closed tanks in most EU countries. (For a list of exceptions, see the LR560 Declaration to EN 302 729, which can be accessed online here (www.siemens.com/LR560.) For open air installations, the following conditions must be observed:

- Installation and maintenance is performed by suitably qualified and trained personnel.
- The LR560 shall be installed only in a permanent fixed position pointing downwards. Its location shall comply with the following two restrictions:
 - It shall be installed with a minimum separation distance of 4 km from radio astronomy sites listed here (<http://www.craf.eu/radio-observatories-in-europe/>) unless special authorization has been provided by the responsible national regulatory authority.
 - If it is installed at a location between 4 and 40 km from any radio astronomy site listed here (<http://www.craf.eu/radio-observatories-in-europe/>), the LR560 shall be installed at a height not exceeding 15m from the ground.

2.1.6 Federal Communications Commission (FCC) conformity (US)

US Installations only: Federal Communications Commission (FCC) rules

- This device has been tested and found to comply with the limits for a Class B digital device, pursuant to Part 15 of the FCC Rules. These limits are designed to provide reasonable protection against harmful interference when the equipment is operated in a commercial environment.
- This device has also been tested and found to comply with the limits §15.256, Subpart C- Intentional radiators, pursuant to Part 15 of the FCC Rules. These limits are designed to provide reasonable protection against harmful interference when the equipment is operated in a commercial environment.

- This device generates, uses, and can radiate radio frequency energy and, if not installed and used in accordance with the instruction manual, may cause harmful interference to radio communications, in which case the user will be required to correct the interference at his/her own expense.
- This device may be used to measure levels in open air environments or outside enclosed tanks, subject to the following conditions:
 - Devices shall be installed and maintained to ensure a vertically downward orientation of the transmit antenna's main beam.
 - Devices shall be installed only at fixed locations. Devices shall not operate while being moved or while inside a moving container.
 - Hand-held applications and residential use are prohibited.

2.1.7 Industry Canada

The SITRANS LR560 complies with Industry Canada standard RSS211 (March 2015).

1. The installation of the SITRANS LR560 shall be done by trained installers, in strict compliance with the manufacturer's instructions.
2. The use of this device is on a "no-interference, no-protection" basis. That is, the user shall accept operations of high-powered radar in the same frequency band which may interfere with or damage this device. However, devices found to interfere with primary licensing operations will be required to be removed at the user's expense.
3. The installer/user of this device shall ensure that it is at least 10 km from the Penticton radio astronomy station (British Columbia latitude: 49° 19' 12" N, longitude: 119° 37'12" W). For devices not meeting this 10 km separation (e.g. the Okanagan Valley, British Columbia) the installer/ user must coordinate with and obtain the written concurrence of the Director of the Penticton radio astronomy station before the equipment can be installed or operated. The Director of the DRAO may be contacted at 250-497-2300 or at NRC.DRAO-OFR.CNRC@nrc-cnrc.gc.ca. (Alternatively, the Manager, Regulatory Standards, Industry Canada, may be contacted.)

2.2 Use in hazardous areas

Qualified personnel for hazardous area applications

Persons who install, connect, commission, operate, and service the device in a hazardous area must have the following specific qualifications:

- They are authorized, trained or instructed in operating and maintaining devices and systems according to the safety regulations for electrical circuits, high pressures, aggressive, and hazardous media.
- They are authorized, trained, or instructed in carrying out work on electrical circuits for hazardous systems.
- They are trained or instructed in maintenance and use of appropriate safety equipment according to the pertinent safety regulations.

 WARNING**Use in hazardous area**

Risk of explosion.

- Only use equipment that is approved for use in the intended hazardous area and labeled accordingly.
- Do not use devices that have been operated outside the conditions specified for hazardous areas. If you have used the device outside the conditions for hazardous areas, make all Ex markings unrecognizable on the nameplate.

2.3 Requirements for special applications

Due to the large number of possible applications, each detail of the described device versions for each possible scenario during commissioning, operation, maintenance or operation in systems cannot be considered in the instructions. If you need additional information not covered by these instructions, contact your local Siemens office or company representative.

Note**Operation under special ambient conditions**

We highly recommend that you contact your Siemens representative or our application department before you operate the device under special ambient conditions as can be encountered in nuclear power plants or when the device is used for research and development purposes.

Description

3.1 SITRANS LR560 overview

SITRANS LR560 is a 2-wire, 78 GHz FMCW radar level transmitter for continuous monitoring of solids and liquids in vessels to a range of 100 m (329 ft). The plug-and-play performance is ideal for all solids applications, including those with extreme dust and high temperatures to +200 °C (+392 °F). The device is an electronic circuit coupled to a lens antenna and flange for quick and easy positioning.

The main benefits of using 78 GHz over devices using lower frequency are:

- very narrow beam, so device is insensitive to mounting nozzle interference and vessel obstructions.
- short wavelength yields very good reflection properties on sloped solids, so aiming towards material angle of repose is usually not necessary.

The technology is very tolerant to buildup on the lens antenna, however an air purge inlet is provided for periodic cleaning if required.



Installing/mounting

4.1 Basic safety instructions

 CAUTION
Hot surfaces resulting from hot process media Risk of burns resulting from surface temperatures above 65 °C (149 °F). <ul style="list-style-type: none">• Take appropriate protective measures, for example contact protection.• Make sure that protective measures do not cause the maximum permissible ambient temperature to be exceeded. Refer to the information in Technical data (Page 160).

Note

Material compatibility

Siemens can provide you with support concerning selection of sensor components wetted by process media. However, you are responsible for the selection of components. Siemens accepts no liability for faults or failures resulting from incompatible materials.

 WARNING
Wetted parts unsuitable for the process media Risk of injury or damage to device. Hot, toxic and corrosive media could be released if the wetted parts are unsuitable for the process medium. <ul style="list-style-type: none">• Ensure that the material of the device parts wetted by the process medium is suitable for the medium. Refer to the information in Technical data (Page 160).

 WARNING
Unsuitable connecting parts Risk of injury or poisoning. In case of improper mounting, hot, toxic, and corrosive process media could be released at the connections. <ul style="list-style-type: none">• Ensure that connecting parts (such as flange gaskets and bolts) are suitable for connection and process media.

 WARNING
Exceeded maximum permissible operating pressure Risk of injury or poisoning. The maximum permissible operating pressure depends on the device version, pressure limit and temperature rating. The device can be damaged if the operating pressure is exceeded. Hot, toxic and corrosive process media could be released. Ensure that maximum permissible operating pressure of the device is not exceeded. Refer to the information on the nameplate and/or in Approvals data (Page 163).

 WARNING
Pressure applications Danger to personnel, system and environment can result from improper installation. <ul style="list-style-type: none">• Improper installation may result in loss of process pressure.

 CAUTION
External stresses and loads Damage to device by severe external stresses and loads (e.g. thermal expansion or pipe tension). Process media can be released. <ul style="list-style-type: none">• Prevent severe external stresses and loads from acting on the device.

4.1.1 Installation location requirements

NOTICE
Strong vibrations Damage to device. <ul style="list-style-type: none">• In installations with strong vibrations, mount the transmitter in a low vibration environment.

NOTICE
Aggressive atmospheres Damage to device through penetration of aggressive vapors. <ul style="list-style-type: none">• Ensure that the device is suitable for the application.

NOTICE
Direct sunlight Device damage. The device can overheat or materials become brittle due to UV exposure. <ul style="list-style-type: none">• Protect the device from direct sunlight.• Make sure that the maximum permissible ambient temperature is not exceeded. Refer to the information in Technical data (Page 160).

 WARNING
Insufficient air supply The device may overheat if there is an insufficient supply of air. <ul style="list-style-type: none">• Install the device so that there is sufficient air supply in the room.• Observe the maximum permissible ambient temperature. Refer to the information in the section Technical data (Page 160).

4.1.2 Proper mounting

4.1.2.1 Incorrect mounting

NOTICE
Incorrect mounting The device can be damaged, destroyed, or its functionality impaired through improper mounting. <ul style="list-style-type: none">• Before installing ensure there is no visible damage to the device.• Make sure that process connectors are clean, and suitable gaskets and glands are used.• Mount the device using suitable tools.

 WARNING
Loss of type of protection Risk of explosion. Damage to device if the enclosure is open or not properly closed. The type of protection specified on the nameplate or in Approvals data (Page 163) is no longer guaranteed. <ul style="list-style-type: none">• Make sure that the device is securely closed.

4.2 Installation instructions

NOTICE
Damage to the flange If mating flange faces are not flat and free of distortion, then bolting the flanged process connection may produce a bending load on the device's flange. Cracking or other damage may occur. Use only 'full-face' flat gaskets surrounding the bolt holes. Ensure mating flange faces are flat and free of distortion.

4.2.1 Pressure equipment directive (PED, 2014/68/EU)

Note

Pressure-rated version only

- SITRANS LR560 units are pressure tested, meeting or exceeding the requirements of the ASME Boiler and Pressure Vessel Code and the European Pressure Equipment Directive.
 - The serial numbers stamped in each process connection body provide a unique identification number indicating date of manufacture.
Example: MMDDYY – XXX (where MM = month, DD = day, YY = year, and XXX= sequential unit produced)
 - Further markings (space permitting) indicate flange configuration, size, pressure class, material, and material heat code.
-

SITRANS LR560 radar level measurement instrument falls below the limits of Article 4, sections 1&2 of the Pressure Equipment directive (2014/68/EU), as a category I pressure accessory. However, in accordance with PED, 2014/68/EU, Article 4, section 3, this equipment has been designed and manufactured in accordance with Sound Engineering Practice (SEP) (see EU Commission Guideline A-05).

4.2.2 Nozzle location

Note

False echoes

For details on avoiding false echoes, see AUTO ECHO SUPPRESSION (2.4.8.1.) (Page 123).

- Avoid central locations on tall, narrow vessels

Beam angle

- Beam angle is the width of the cone where the energy density is half of the peak energy density.
- The peak energy density is directly in front of and in line with the antenna.
- There is a signal transmitted outside the beam angle, therefore false targets may be detected.

Emission cone

- Keep emission cone free of interference from ladders, pipes, I-beams, or filling streams.



① Emission cone

4.2.3 Environment

- Provide easy access for viewing the display and programming via the local push buttons or the handheld programmer.
- Provide an environment suitable to the housing rating and materials of construction.

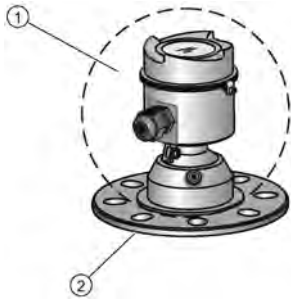

- ① ambient temperature: $-40\text{ }^{\circ}\text{C}$ to $+80\text{ }^{\circ}\text{C}$ ($-40\text{ }^{\circ}\text{F}$ to $+176\text{ }^{\circ}\text{F}$)
- ② process temperature: -40 to $+100\text{ }^{\circ}\text{C}$ (-40 to $+212\text{ }^{\circ}\text{F}$) or -40 to $+200\text{ }^{\circ}\text{C}$ (-40 to $+392\text{ }^{\circ}\text{F}$) depending on the version

4.2.4 Sunshield

The LR560 display can be protected by an optional sun shield if the instrument will be mounted in direct sunlight.

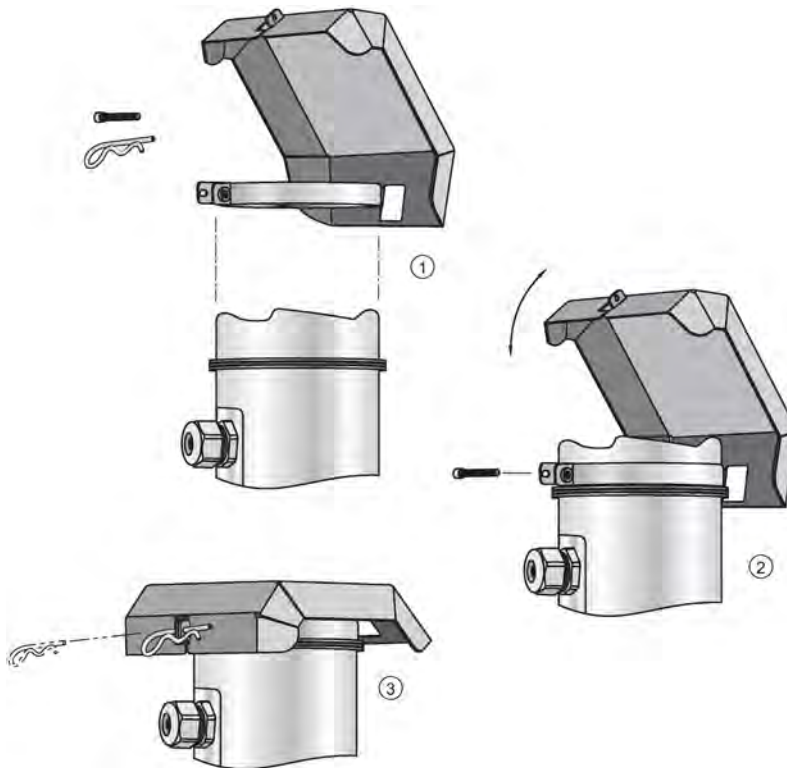

4.2.5 Aimer adjustment

Note

Measuring material in the cone

Aiming will assist in measuring material in the cone.

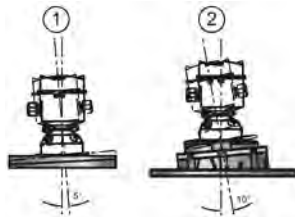

① 3" flange

② 4" and 6" flange

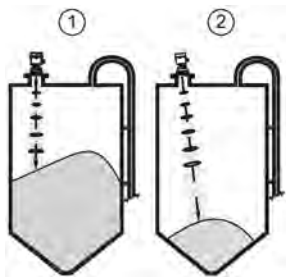

- ① Aiming is not required for signal optimization with 78 GHz frequency.
- ② Aiming will assist in measuring material in the cone.

1. For 4 and 6" Aimer: loosen the set screws in the locking ring.
 - Holding the electronics enclosure firmly, loosen the Aimer locking ring using the supplied C spanner, until the LR560 drops down slightly. The enclosure can then be turned freely.
2. Direct SITRANS LR560 so the antenna is pointed at an angle perpendicular to the material surface, if possible.
3. When the desired position is reached, re-tighten the locking ring using the C spanner, and tighten set screws.

4.2.6 Air purging system

For convenient cleaning, a purging inlet is provided above the antenna. The system provides a 1/8" inlet (female thread) above the antenna where clean, dry air passes to the face of the antenna lens to clean it. The customer will supply the purging air by a manual or automatic valve system.

Note

Air Purging considerations

- Purge duration, pressure, and interval, will vary with each application. It is the user's responsibility to determine the requirements depending on the application and cleaning required.
- Short duration bursts of high pressure provide more effective cleaning than continuous low pressure air.
- Some dust particles are highly abrasive and can cause wear on the lens face over time if continuous air purge is used, therefore short bursts are recommended.
- It is the customer's responsibility to ensure that any vacuum or pressure in the measured vessel is maintained, considering the hole that passes through the process connection and SITRANS LR560 antenna system.

Air Consumption (flow rate versus applied pressure)

Air pressure (psi)	Approx. inlet volume flow rate (SCFM)
20	5
40	10
50	15
80	20
100	25
110	30
Recommended 90 to 110 psi for effective cleaning ¹⁾	

¹⁾ Air pressure in vessel can affect purge operation.

Purge connection

- The purge connection is closed by the manufacturer, using a 1/8" plug.
- When the plug is removed to connect a purging system, the operator is responsible for ensuring that the purging circuit conforms to "Ex" requirements: for example, by fitting an NRV valve. Air pressure in vessel can affect purge operation.



① purge process connection with factory-installed 1/8" NPT plug

4.2.7 Removable display

The optional display can be rotated as required, to one of 4 positions, 90 degrees apart, see Connecting SITRANS LR560 (Page 30). It can also be used to transfer parameters from one device to another, see COPY PARAMETERS FROM DISPLAY (1.4) (Page 110).



4.3 Disassembly

4.3.1 Incorrect disassembly

! WARNING

Incorrect disassembly

The following risks may result from incorrect disassembly:

- Injury through electric shock
- Risk through emerging media when connected to the process
- Risk of explosion in hazardous area

In order to disassemble correctly, observe the following:

- Before starting work, make sure that you have switched off all physical variables such as pressure, temperature, electricity etc. or that they have a harmless value.
- If the device contains hazardous media, it must be emptied prior to disassembly. Make sure that no environmentally hazardous media are released.
- Secure the remaining connections so that no damage can result if the process is started unintentionally.

! DANGER

Pressure applications

Danger to personnel, system and environment will result from improper disassembly.

- Never attempt to loosen, remove, or disassemble process connection while vessel contents are under pressure.

Connecting

5.1 Basic safety information

WARNING

Unsuitable cables, cable glands and/or plugs

Risk of explosion in hazardous areas.

- Use only cable glands/plugs that comply with the requirements for the relevant type of protection.
- Tighten the cable glands in accordance with the torques specified in Technical data (Page 160).
- Close unused cable inlets for the electrical connections.
- When replacing cable glands, only use cable glands of the same type.
- After installation, check that the cables are seated firmly.

WARNING

Hazardous contact voltage

Risk of electric shock in case of incorrect connection.

- For the electrical connection specifications, refer to the information in Technical data (Page 160).
- At the mounting location of the device observe the applicable directives and laws for installation of electrical power installations with rated voltages below 1000 V.

NOTICE

Condensation in the device

Damage to device through formation of condensation if the temperature difference between transportation or storage and the mounting location exceeds 20 °C (36 °F).

- Before taking the device into operation, let the device adapt for several hours in the new environment.

WARNING

Missing PE/ground connection

Risk of electric shock.

Depending on the device version, connect the power supply as follows:

- **Power plug:** Ensure that the used socket has a PE/ground conductor connection. Check that the PE/ground conductor connection of the socket and power plug match each other.
- **Connecting terminals:** Connect the terminals according to the terminal connection diagram. First connect the PE/ground conductor.

5.1.1 Incorrect connection to power source

 WARNING**Incorrect connection to power source**

Risk to personnel, system and environment can result from improper power connection.

- The DC input terminals shall be supplied from a source providing electrical isolation between the input and output, in order to meet the applicable safety requirements of IEC 61010-1. For example, Class 2 or Limited Energy Source.
- All field wiring must have insulation suitable for rated voltages.

 WARNING**Unprotected cable ends**

Risk of explosion through unprotected cable ends in hazardous areas.

- Protect unused cable ends in accordance with IEC/EN 60079-14.

 WARNING**Improper laying of shielded cables**

Risk of explosion through compensating currents between hazardous area and the non-hazardous area.

- Shielded cables that cross into hazardous areas should be grounded only at one end.
- If grounding is required at both ends, use an equipotential bonding conductor.

 WARNING**Incorrect selection of type of protection**

Risk of explosion in areas subject to explosion hazard.

This device is approved for several types of protection.

1. Decide in favor of one type of protection.
2. Connect the device in accordance with the selected type of protection.
3. In order to avoid incorrect use at a later point, make the types of protection that are not used permanently unrecognizable on the nameplate.

Note**Electromagnetic compatibility (EMC)**

You can use this device in industrial environments, households and small businesses.

For metal housings there is an increased electromagnetic compatibility compared to high-frequency radiation. This protection can be increased by grounding the housing, see Connecting (Page 28).

5.2 Connecting SITRANS LR560

Note

- Check the device label on your instrument, to verify the approval rating.
 - Use appropriate conduit seals to maintain IP or NEMA rating.
 - Use twisted pair cable: AWG 22 to 14 (0.34 mm² to 2.5 mm²).
 - Separate cables and conduits may be required to conform to standard instrumentation wiring practices or electrical codes.
-

1. Loosen locking screw.
2. Remove LR560 lid.
3. Remove optional display by gently turning the display a quarter turn counter-clockwise until it is free.
4. Strip the cable jacket for approximately 70 mm (2.75") from the end of the cable, and thread the wires through the gland¹⁾.
5. Connect the wires to the terminals as shown: the polarity is identified on the terminal block.
6. Ground the instrument according to local regulations.
7. Tighten the gland to form a good seal.
8. Replace optional display and device lid.
9. Tighten locking screw.

¹⁾ If cable is routed through conduit, use only approved suitable-size hubs for waterproof applications.

Removing the lid and display



Terminal block

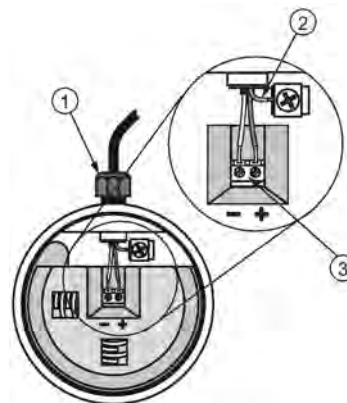

- ① cable gland (or NPT cable entry)
- ② cable shield
- ③ instrument connection

5.3 Configuration diagrams

5.3.1 Basic configurations

5.3.1.1 Configuration via PCI/PCMCIA card

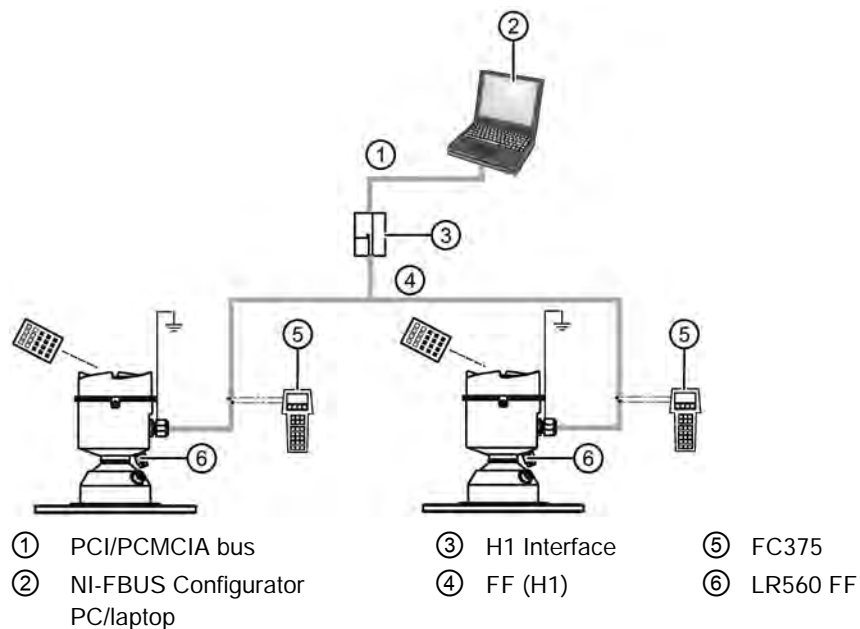

5.3.1.2 Configuration via linking device

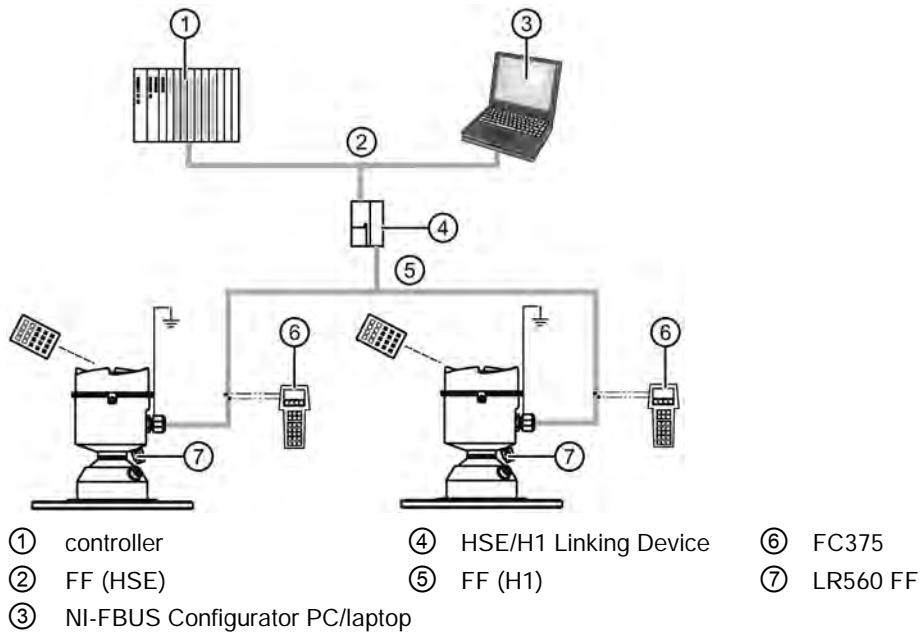

5.3.2 Hazardous area configurations

5.3.2.1 Configuration via PCI/PCMCIA card

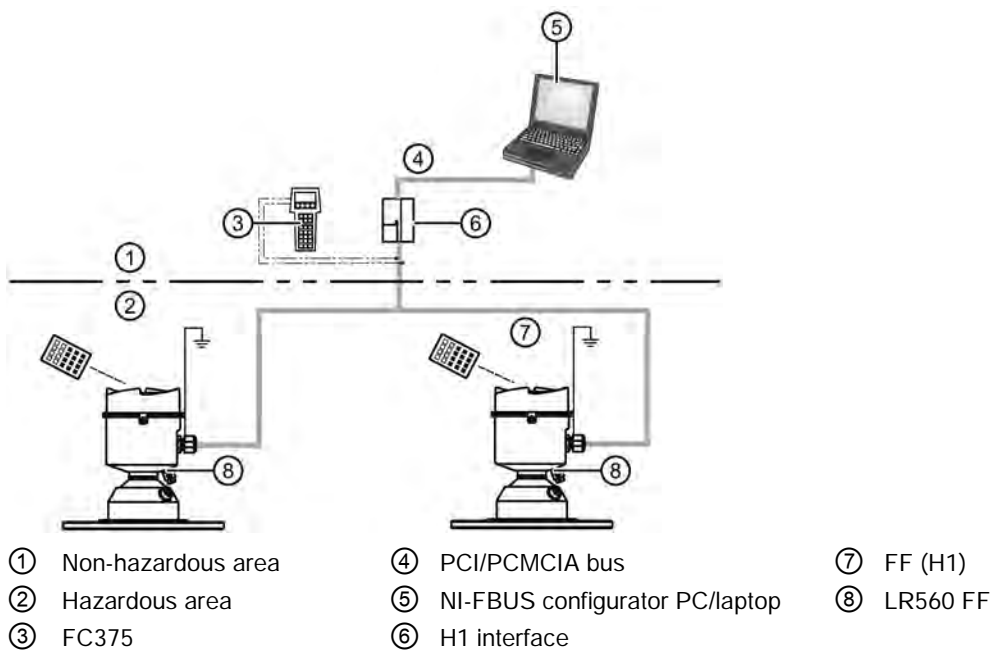

5.3.2.2 Configuration via Gateway and linking device

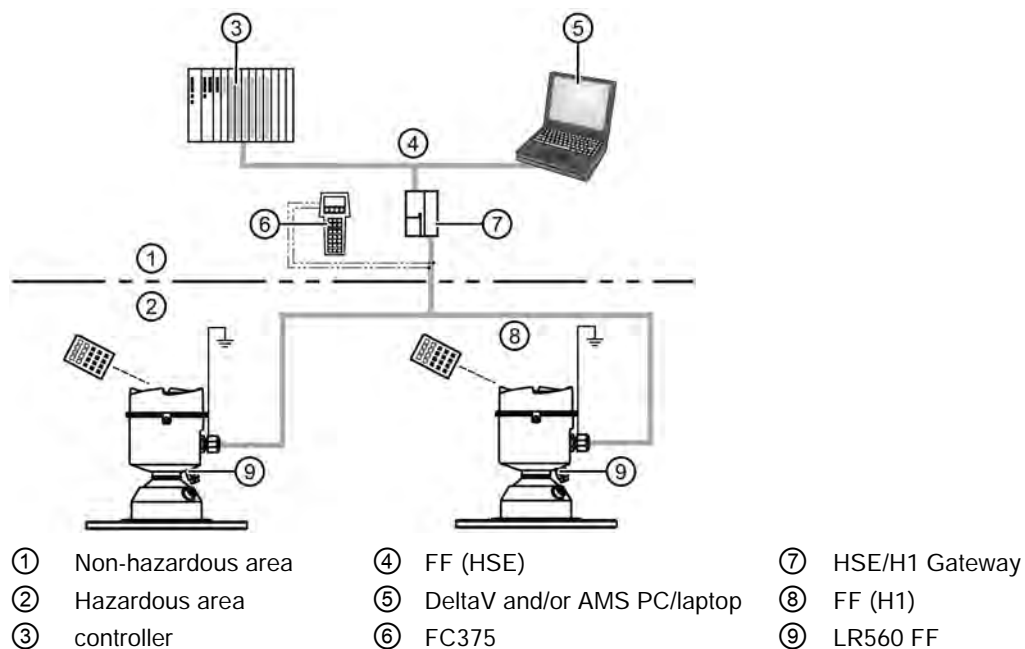

5.4 Nameplates for hazardous area installations

Note**Sample nameplate**

The serial number and assembly location shown on the nameplate are given as examples only.

5.4.1 FOUNDATION FIELDBUS Non-Sparking/Energy Limited wiring (Europe) and Dust Ignition Proof wiring (Europe/International)

FOUNDATION FIELDBUS

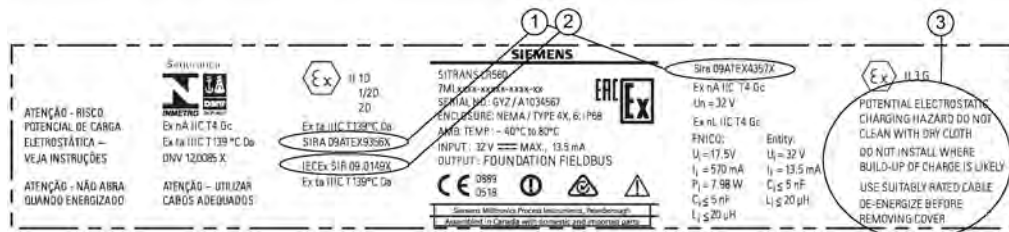

- ① ATEX certificate number The ATEX certificates can be found on the product website. Go to LR560 (www.siemens.com/LR560) > **Support** > **Approvals/Certificates**. For more information on hazardous area approvals, see Technical data (Page 160).
- ② IECEx certificate number The IECEx certificate can be found on the IECEx website. Go to IECEx (<http://iecex.iec.ch>) > **Certified Equipment** and enter the IECEx SIR number.
- ③ Safety notes Potential electrostatic charging hazard. Do not clean with dry cloth. Do not install where build-up of charge is likely. Use suitably rated cable. De-energize before removing cover.

5.4.2 FM/CSA Class 1, Div 2 installation and connection drawing

The FM/CSA Class 1, Div 2 connection drawing (A5E02795836) listed on the device nameplate can be downloaded from the Siemens Industry Image Database:

FM/CSA Class 1, Div 2 connection drawing

(http://www.automation.siemens.com/bilddb/index.aspx?gridview=view2&objkey=G_FI01_XX_05528&showdetail=true&view=Search)

5.5 Instructions specific to hazardous area installations

5.5.1 (Reference European ATEX Directive 2014/34/EU, Annex II, 1.0.6)

The following instructions apply to equipment covered by certificate number SIRA 09ATEX9356X and Sira 09ATEX4357X.

1. For use and assembly and details of marking/coding, refer to the main instructions.
2. The equipment is certified for use as Category 1D, 1/2D and 2D equipment per certificate Sira 09ATEX9356X and may be used in hazardous zones 20, 21 and 22. The equipment is also certified for use as Category 3G equipment per certificate Sira 09ATEX4357X and may be used in hazardous zone 2.

3. This equipment has a maximum surface temperature of 139 °C (in an 80 °C ambient). Refer to the applicable code of practice for selection of this equipment with respect to specific dust ignition temperatures.
4. The equipment is certified for use in an ambient temperature range of -40 °C to 80 °C.
5. The equipment has not been assessed as a safety related device (as referred to by Directive 2014/34/EU Annex II, clause 1.5).
6. Installation and inspection of this equipment shall be carried out by suitably trained and authorized personnel in accordance with the applicable code of practice.
7. The equipment shall be installed such that the supply cable is protected from mechanical damage. The cable shall not be subjected to tension or torque. The equipment manufacturer is not responsible for providing the supply cable.
8. Repair of this equipment shall be carried out by suitably trained and authorized personnel in accordance with the applicable code of practice.

5.5.2 Special conditions for safe use

SPECIAL CONDITIONS FOR SAFE USE

The 'X' suffix to the certificate number relates to the following special condition(s) for safe use:

- Parts of the enclosure may be non-conducting and may generate an ignitioncapable level of electrostatic charge under certain extreme conditions. The user should ensure that the equipment is not installed in a location where it may be subjected to external conditions (such as high-pressure steam), which might cause a build-up of electrostatic charge on non-conducting surfaces.
- The end user must ensure that an ingress protection of at least IP65 is maintained at each entry to the enclosure by use of a blanking element or cable entry device that meets the requirements of the protection concepts type 'n' or increased safety 'e' or flameproof 'd'.
- The supply to the equipment shall be rated for a prospective short-circuit current of not more than 10 kA and shall be protected by a suitably-rated fuse.

Commissioning

6.1 Basic safety notes

 WARNING**Improper commissioning in hazardous areas**

Device failure or risk of explosion in hazardous areas.

- Do not commission the device until it has been mounted completely and connected in accordance with the information in Installing/mounting (Page 19).
- Before commissioning take the effect on other devices in the system into account.

 WARNING**Commissioning and operation with pending error**

If an error message appears, correct operation in the process is no longer guaranteed.

- Check the gravity of the error.
- Correct the error.
- If the error still exists:
 - Take the device out of operation.
 - Prevent renewed commissioning.

 WARNING**Hot surfaces**

Risk of burns resulting from hot surfaces.

- Take corresponding protective measures, for example by wearing protective gloves.

 WARNING**Loss of type of protection**

Risk of explosion. Damage to device if the enclosure is open or not properly closed. The type of protection specified on the nameplate or in Technical data (Page 160) is no longer guaranteed.

- Make sure that the device is securely closed.

 **WARNING**

Hazardous contact voltage

Risk of injury through hazardous contact voltage when the device is open or not completely closed.

The degree of protection specified on the nameplate or in Technical data (Page 160) is no longer guaranteed if the device is open or not properly closed.

- Make sure that the device is securely closed.

 **DANGER**

Toxic gases and liquids

Danger of poisoning when venting the device: if toxic process media are measured, toxic gases and liquids can be released.

- Before venting ensure that there are no toxic gases or liquids in the device, or take the appropriate safety measures.

 **WARNING**

Loss of explosion protection

Risk of explosion in hazardous areas if the device is open or not properly closed.

- Close the device as described in Installing/mounting (Page 19).

 **WARNING**

Hazardous gases in the enclosure

Risk of explosion.

Hazardous gases are gases that can explode and have a gas concentration of more than 25% of the lower explosion limit (LEL). Under normal ambient conditions the LEL is the risk threshold when handling these gases. However, special operating conditions can lower the potential risk from these gases under the LEL. A value of 25% of the LEL is regarded as definitely safe.

- Do not introduce combustible or hazardous gases into a restricted-breathing enclosure (type of protection Ex nR).



6.2 Activating the radar device

Power up the instrument. A transition screen showing first the Siemens logo and then the current firmware revision is displayed while the first measurement is being processed. The first time the device is configured, you will be prompted to select a language (English, German, French, Spanish or Chinese).

Press **Mode**  to toggle between Measurement and Program mode.

Note

Toggle between *Program* and *Measurement* modes

- To enter Program mode using the device buttons, press RIGHT . Press LEFT  to return to Measurement mode.
 - To toggle between Measurement and Program Mode using the handheld programmer, press Mode .
-

6.3 The LCD display

Measurement mode display¹⁾²⁾: Normal operation

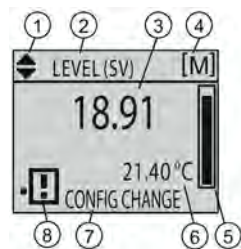

- | | | | |
|---|---|---|------------------------------------|
| ① | toggle indicator ¹⁾ for PV or SV (primary or secondary values) | ⑦ | text area displays status messages |
| ② | selected operation: level, space, or distance | ⑧ | device status indicator |
| ③ | measured value (level, space, or distance) | ⑧ | service required icon appears |
| ④ | units | | |
| ⑤ | bar graph indicates level | | |
| ⑥ | secondary region indicates on request ²⁾ electronics temperature, echo confidence, loop current, or distance | | |

Fault present:
S: 0 LOE



PROGRAM mode display

Navigation view

- A visible menu bar indicates the menu list is too long to display all items.
- The depth of the item band on the menu bar indicates the length of the menu list: a deeper band indicates fewer items.
- The position of the item band indicates the approximate position of the current item in the list. A band halfway down the menu bar indicates the current item is halfway down the list.

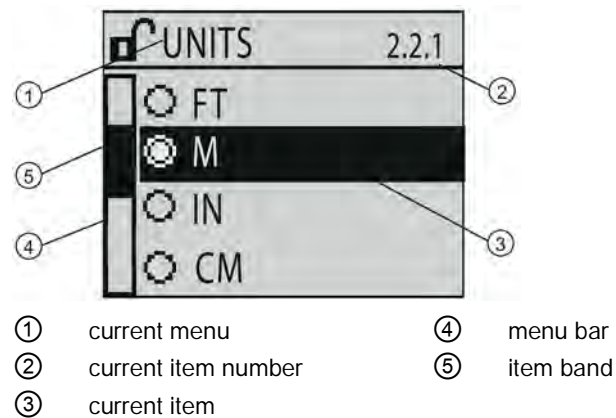

Parameter view

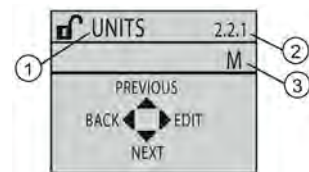

Edit view

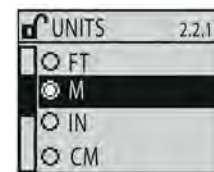

- 1) Press UP or DOWN arrow to switch
2) In response to a key press request. For details, see Local operation (Page 40).

6.4 Commissioning via local display

6.4.1 Local operation

SITRANS LR560 carries out its level measurement tasks according to settings made via parameters. The settings can be modified locally via the optional local graphical display which consists of an LCD display with buttons. You can use either the push buttons or an infrared handheld programmer to make changes.



① push buttons

A Quick Start Wizard provides an easy step-by-step procedure to help you configure the device for a simple application. There are two ways to access the wizard:

- locally, see Quick Start Wizard via the local display push buttons (Page 40) or Quick Start Wizard via the handheld programmer (Page 48)
- from a remote location, see Operating via AMS Device Manager (Page 54)
- see Application example (Page 53) for an illustration, and for the complete list of parameters, see Parameter Reference (Page 108).

6.4.2 Quick Start Wizard via the local display push buttons

1. Press RIGHT to enter Program Mode.
2. Choose Quick Start (1.), and then Quick Start Wizard (1.1.).
3. Follow the steps then choose Finish to save Quick Start parameter changes and return to Program menu, or press LEFT to return to Measurement mode.

To add or delete digits using the push buttons:

When the enter icon is lit, press UP to insert a digit on the right, DOWN to delete the right-most digit, RIGHT to accept the value, or LEFT to cancel.

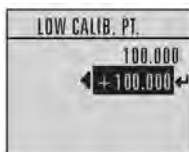

1. Navigate to the parameter you wish to modify and press RIGHT to edit it. The value will be highlighted.
2. Press UP or DOWN to delete the highlighted value, or LEFT to modify the value from the left-most digit, starting with the plus/minus sign.

3. With the plus or minus sign highlighted, press up or down arrow to change it. Press right arrow to highlight the next digit to the right.
4. Use UP ▲ or DOWN ▼ to modify the highlighted digit. Scroll past 9 to reach the decimal point.
5. When the value is complete, press RIGHT ► until the Enter icon is highlighted, then press RIGHT ► to accept the value.

To modify a text string:

1. Navigate to the parameter you wish to modify and press RIGHT ► to edit it. The string will be highlighted.
2. Follow the same steps as above, to add, delete, or modify characters.

6.5 Commissioning via handheld programmer

6.5.1 Handheld programmer (Part No. 7ML1930-1BK)

The programmer is ordered separately.



6.5.2 Hand programmer

The handheld programmer used with this device contains lithium batteries that are non-replaceable.

6.5.3 Lithium batteries

Lithium batteries are primary power sources with high energy content designed to provide the highest possible degree of safety.



WARNING









Potential hazard

Lithium batteries may present a potential hazard if they are abused electrically or mechanically. Observe the following precautions when handling and using lithium batteries:

- Do not short-circuit, recharge or connect with false polarity.
- Do not expose to temperatures beyond the specified temperature range.
- Do not incinerate.
- Do not crush, puncture or open cells or disassemble.
- Do not weld or solder to the battery's body.
- Do not expose contents to water.

6.5.4 Key functions in measurement mode

Key functions in measurement mode

Key	Function	Result
	Updates the loop current	New value is shown in secondary region of local display.
	Updates internal enclosure temperature reading	
	Updates echo confidence value	New value is shown in secondary region of local display.
	Updates distance measurement	
	Mode opens PROGRAM mode	Opens the menu level last displayed in this power cycle, unless power has been cycled since exiting PROGRAM mode or more than 10 minutes have elapsed since PROGRAM mode was used. Then top level menu will be displayed.
	Home toggles local display	Local display toggles between % or linear units
	RIGHT arrow opens PROGRAM mode	Opens the top level menu.
 	UP or DOWN arrow toggles between linear units and percent	Local display shows measured value in either linear units or percent.

6.5.5 Programming

6.5.5.1 Programming the radar device

Note

- While the device is in PROGRAM mode the output remains fixed and does not respond to changes in the device.
 - The device automatically returns to Measurement mode after a period of inactivity in PROGRAM mode (between 15 seconds and 2 minutes, depending on the menu level).
-

6.5.5.2 Parameter menus

Change parameter settings and set operating conditions to suit your specific application. For remote operation, see Operating via AMS Device Manager (Page 54)

Note

For the complete list of parameters with instructions, see Parameter Reference (Page 108).

Parameters are identified by name and organized into function groups, then arranged in a 5-level menu structure, see HMI menu (Page 184).

1. QUICK START

2. SETUP

2.1 IDENTIFICATION

2.2 DEVICE

2.5. AIFB1

2.5.1. STATIC REV. NO.









2.5.2. MODE

2.5.3. CHANNEL

2.5.4. INPUT SCALING

2.5.4. 1. LOWER VALUE







6.5.5.3 Parameter menus

1. Enter PROGRAM mode	<p>Using local display buttons:</p> <ul style="list-style-type: none"> • Press RIGHT  <p>Using handheld programmer:</p> <ol style="list-style-type: none"> 1. Point the programmer at the display from a maximum distance of 300 mm (1 ft). 2. RIGHT  activates PROGRAM mode and opens menu level 1. 3. Mode opens the menu level last displayed in PROGRAM  within the last 10 minutes, or menu level 1 if power has been cycled since then.
2. Editing in PROGRAM mode	<p>To select a listed option:</p> <ol style="list-style-type: none"> 1. Navigate to the desired parameter. 2. Press RIGHT  to open parameter view. 3. Press RIGHT  again to open Edit mode. The current selection is highlighted. Scroll to a new selection. 4. Press RIGHT  to accept it. 5. The local display returns to parameter view and displays the new selection. <p>To change a numeric value:</p> <ol style="list-style-type: none"> 1. Navigate to the desired parameter. 2. Press RIGHT  to open parameter view. 3. The current value is displayed. 4. Press RIGHT  again to open Edit mode. The current value is highlighted. Key in a new value. Press RIGHT  to accept it. 5. The local display returns to parameter view and displays the new selection.











Note**Navigation**

- In Navigation mode, ARROW keys move to the next menu item in the direction of the arrow.
- For Quick Access to parameters via the handheld programmer, press Home , and then enter the menu number, for example: 3.2. Echo Profile.

Key functions in Navigation mode

Key	Name	Menu level	Function
	UP or DOWN arrow	menu or parameter	Scroll to previous or next menu or parameter.
			
	RIGHT arrow	menu	Go to first parameter in the selected menu, or open next menu.
		parameter	Open Edit mode.
	LEFT arrow	menu or parameter	Open parent menu.
	Mode	menu or parameter	Change to MEASUREMENT mode.
	Home	menu or parameter	Open top level menu: menu 1.

Key functions in Program mode









Key	Name		Function
	UP or DOWN arrow	Selecting options	Scrolls to item.
		Alphanumeric editing	<ul style="list-style-type: none"> • Increments or decrements digits • Toggles plus and minus sign
	RIGHT arrow	Selecting options	<ul style="list-style-type: none"> • Accepts the data (writes the parameter) • Changes from Edit to Navigation mode
		Numeric editing	<ul style="list-style-type: none"> • Moves cursor one space to the right • Or with cursor on Enter sign, accepts the data and changes from Edit to Navigation mode
	LEFT arrow	Selecting options	Cancels Edit mode without changing the parameter
		Numeric editing	<ul style="list-style-type: none"> • Moves cursor to plus/minus sign if this is the first key pressed • Or moves cursor one space to the left. • Or with cursor on Enter sign, cancels the entry
	Clear	Numeric editing	Erases the display
	Decimal point	Numeric editing	<ol style="list-style-type: none"> 1. In Edit mode, enter a decimal point. 2. In Parameter View, press  to store menu path to that parameter, and create custom Secondary Value to be displayed in secondary region of LCD.
	Plus or minus sign	Numeric editing	Changes the sign of the entered value.
 to 	Numeral	Numeric editing	Enters the corresponding character. Editing in PROGRAM mode

6.5.5.4 Quick Start Wizard via the handheld programmer

Note

- A reset to factory defaults should be performed before running the Quick Start Wizard if the device has been used in a previous application. See Quick Start Wizard via the local display push buttons (Page 40).
- The Quick Start wizard settings are inter-related and changes apply only after you select **Finish** in the Wizard Complete step.
- Do not use the Quick Start wizard to modify parameters: see instead Parameter Reference (Page 108). Perform customization for your application only after the Quick Start has been completed.

Quick Start Wizard

1. Point the programmer at the display from a maximum distance of 300 mm (1 ft.), then press RIGHT  to activate PROGRAM mode and open menu level 1.
2. Press RIGHT  twice to navigate to menu item 1.1 and open parameter view.
3. Press RIGHT  to open Edit mode or DOWN  to accept default values and move directly to the next item.
4. To change a setting, scroll to the desired item or key in a new value.
5. After modifying a value, press RIGHT  to accept it and press DOWN  to move to the next item.
6. At any time, you can press UP  to go back, or LEFT  to cancel and return to Measurement mode.



Vessel

Factory setting:	STEEL
Setting range:	STEEL or CONCRETE
Purpose:	Select vessel construction material.
Description:	<ul style="list-style-type: none"> • Selecting either STEEL or CONCRETE does a functional reset; see MASTER RESET (4.1.) (Page 134). • Selecting STEEL changes the setting for POSITION DETECT (2.4.5.2.) (Page 119) to Rising Edge and for ALGORITHM (2.4.5.1.) (Page 119) to F. • Selecting CONCRETE changes the setting for POSITION DETECT (2.4.5.2.) (Page 119) to Rising Edge and for ALGORITHM (2.4.5.1.) (Page 119) to ALF.

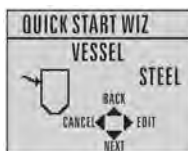
Parameter view**Edit mode****Response rate**

Factory setting:	MED		
Setting range:	Response rate	Fill rate per Minute/Empty rate per Minute	Damping Filter
	SLOW	0.1 m/min (0.32 ft/min)	600 s
	MED	1.0 m/min (3.28 ft/min)	60 s
	FAST	10.0 m/min (32.8 ft/min)	0 s
Purpose:	Sets the reaction speed of the device to measurement changes in the target range. Selecting SLOW changes setting for AVERAGE AMOUNT (2.8.3.) (Page 131) to 0.9.		
Description:	Use a setting just faster than the maximum vessel filling or vessel emptying rate (whichever is greater).		

Parameter view**Edit mode****Units**

Factory setting:	m
Setting range:	m, cm, mm, ft, in
Purpose:	Sensor measurement units.

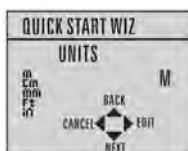
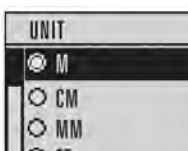
Parameter view**Edit mode**

Operation

Factory setting:	LEVEL	
Setting range:	LEVEL	Distance to material surface referenced from Low calibration point
	SPACE	Distance to material surface referenced from High calibration point
	DISTANCE	Distance to material surface referenced from Sensor reference point
Purpose:	Sensor measurement units.	

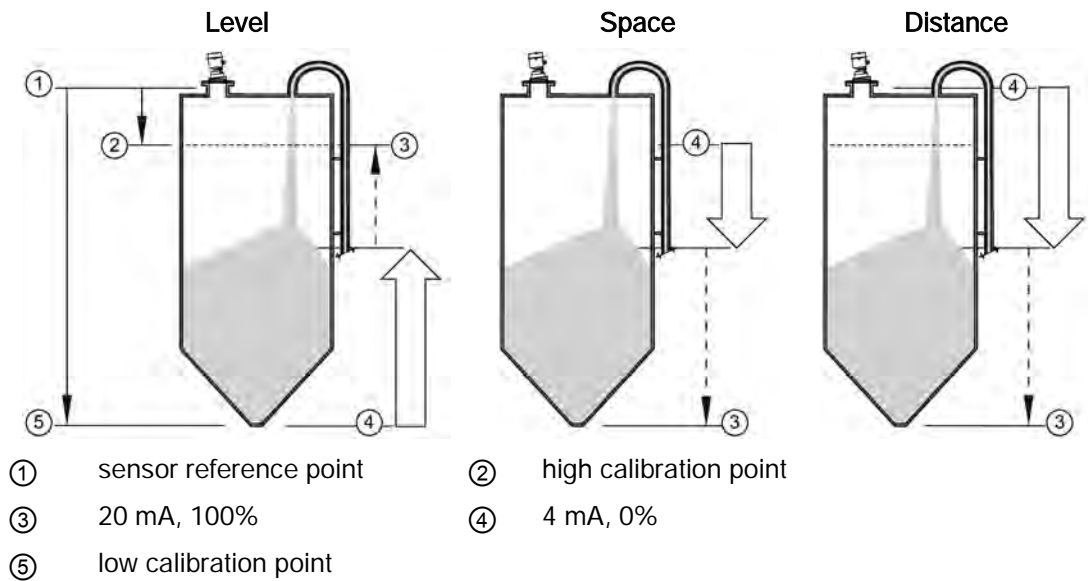
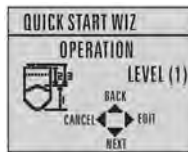

Low calibration point

Factory setting:	40.000 m or 100.000 m
Setting range:	0.000 to 40.000 m or 0.000 to 100.000 m
Purpose:	Distance from Sensor Reference to Low Calibration Point: usually process empty level. See Dimension drawings (Page 165) for an illustration.

Parameter view

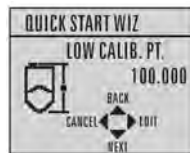

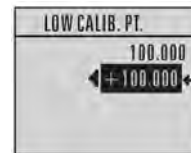

Edit mode





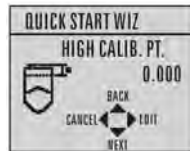
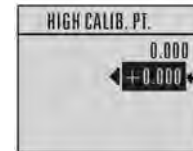



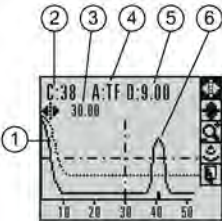

High calibration point

Factory setting:	0.000 m
Setting range:	0.000 to 40.000 m or 0.000 to 100.000 m
Purpose:	Distance from Sensor Reference Point to High Calibration Point: usually process full level. See Dimension drawings (Page 165) for an illustration.

Parameter view**Edit mode****Wizard complete**

Setting range:	BACK, CANCEL, FINISH (Display returns to 1.1 Quick Start Wizard menu when Quick Start is successfully completed.)
Description:	To transfer Quick Start values to the device and return to Program menu, press DOWN  (Finish). Then press LEFT  to return to Measurement mode.

6.5.5.5 Requesting an Echo Profile

1. Enter PROGRAM mode	Navigate to: Level Meter > Diagnostics (3.) > Echo profile (3.1.)	
	Press RIGHT  to request a profile.	
	 <p>① TVT ② Confidence ③ Distance from Low Calibration Point to vertical cross-hair ④ Algorithm: tF (trueFirst) ⑤ Distance from flange face to target ⑥ Echo</p>	
2. Accessing features	Use UP  or DOWN  to scroll to an icon. When an icon is highlighted, that feature becomes active.	
	Move a cross-hair	Press RIGHT  to increase the value, LEFT  to decrease.
	Zoom into an area	Position the intersection of the cross-hairs at the center of that area, select Zoom, and press RIGHT  . Press LEFT  to Zoom out.
	Update the profile	Select Measure and press RIGHT  .
	Return to the previous menu	Select Exit then press RIGHT  .

6.6 Device Address

Note

The address can only be changed from a remote master such as NI-FBUS Configurator or DeltaV. For further details see **Addressing** in the manual, *Foundation Fieldbus for Level instruments (7ML19985MP01)*.

Read only. The unique address of the device on the network.

1. In PROGRAM mode, navigate to: **Level Meter** > COMMUNICATION (5.) (Page 145) > Device Address (5.2.) (Page 145) to view the device address.
2. Press **Mode** to return to Measurement mode.

6.7 Application example

The application is a vessel that takes an average 3 hours (180 minutes) to fill and 3 weeks to empty.

$$\begin{aligned} \text{Fill rate} &= 0.08 \text{ m/minute} [(\text{Low Cal Pt. minus High Cal Pt.}) / \text{fastest of fill or empty time}] \\ &= (15.5 \text{ m} - 1 \text{ m}) / 180 \text{ min.} \\ &= 14.5 \text{ m} / 180 \text{ min.} = 0.08 \text{ m/min.} \end{aligned}$$

Therefore SLOW response rate (0.1 m/minute) can be selected.

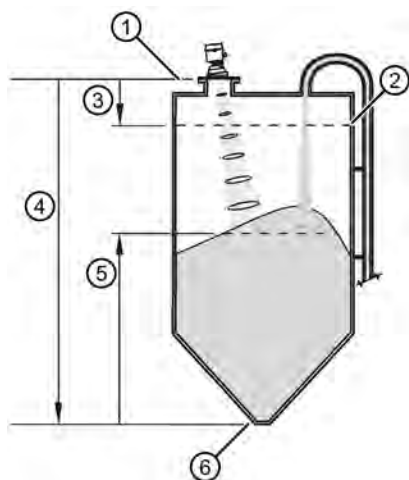

- ① sensor reference point
- ② high calibration point
- ③ 1.0 m
- ④ 15.5 m
- ⑤ level
- ⑥ low calibration point

Quick Start Parameter	Setting	Description
Vessel	STEEL	Selects vessel construction material.
Response Rate	SLOW	Resets fill rate and empty rate to 0.1 m/minute.
Units	m	Sensor measurement units.
Operation	LEVEL	Material level referenced from low calibration point
Low Calibration Point	15.5	Process empty level.
High Calibration Point	1.0	Process full level.
Wizard Complete	FINISH	Save new settings and exit Wizard

Operating

7.1 Remote operation

7.1.1 Operating via AMS Device Manager

7.1.1.1 Functions in AMS Device Manager

Functions in AMS Device Manager

AMS Device Manager monitors the process values, alarms and status signals of the device. It allows you to display, compare, adjust, verify, and simulate process device data.

Device configuration and monitoring is performed via parameters organized into three function groups:

- Configure/Setup
- Device Diagnostics
- Process Variables

The way the device handles these parameters is described in terms of a Block Model. See the manual, **Foundation Fieldbus for Level Instruments (7ML19985MP01)**, for details.

Four blocks have responsibility for handling these parameters:

- Level Transducer Block (LTB)
- LCD Transducer Block (LCD)
- Diagnostic Transducer Block (DIAG)
- Resource Block (RES)

Within each function group, parameters are associated with a particular Function Block.

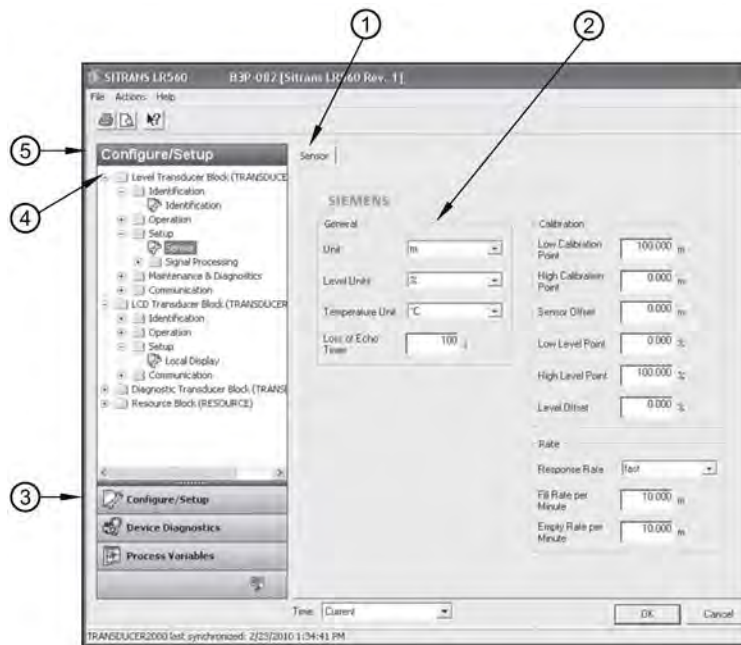

- ① active parameter tab
- ② parameter dialog window
- ③ button access to function groups
- ④ active function block (LTB)
- ⑤ active function group (highlighted)

Key Features of AMS Device Manager version 9.0.

Note

- For details on using the features below, see the page listed.
- In the table below, (LTB) or (RESOURCE) following the parameter name indicates which block handles the feature in question.

Feature Page	Description
Quick Start Wizard steps (Page 60)	Device configuration for simple applications
Echo Profile	Echo profile viewing
TVT (Auto False Echo Suppression)	Screen out false echoes automatically
Maintenance & Diagnostics (LTB) (Page 73)	Set schedules and reminders for sensor maintenance and service
Maintenance & Diagnostics (RESOURCE) (Page 84)	Set schedules and reminders for device maintenance and calibration
Security (RESOURCE) (Page 87)	Protect security and communication parameters from modification by the maintenance user
Alarms & Errors (LTB) (Page 87)	Monitor process errors and alarms
Alarms & Errors (RESOURCE) (Page 90)	Monitor device errors and alarms
Process Variables (Level Transducer Block - LTB) (Page 93)	Monitor process variables and level trend

Block location of features

Feature	Function Group	Block
Quick Start Wizard steps (Page 60)	Configure/setup	RESOURCE
Echo profile (Page 73)		LTB
TVT (Page 70)		LTB
Maintenance & Diagnostics (LTB) (Page 73)		LTB
Maintenance & Diagnostics (RESOURCE) (Page 84)		RESOURCE
Security (RESOURCE) (Page 87)		RESOURCE
Alarms & Errors (LTB) (Page 87)	Device	LTB
Alarms & Errors (RESOURCE) (Page 90)	Diagnostics	RESOURCE
Process Variables (Level Transducer Block - LTB) (Page 93)	Process Variables	LTB

7.1.1.2 Programming via AMS Device Manager

Note

- While the device is in PROGRAM mode the output remains active and continues to respond to changes in the device.
 - Do not use the handheld programmer at the same time as AMS Device Manager, or erratic operation may result. To disable operation via the handheld programmer, see LOCAL OPERATION (6.2.2.) (Page 146).
-

Navigating through the parameters

- A navigation window on the left-hand side of the screen allows you to navigate through the parameter menu structure, see AMS menu structure (Page 97).
- Some parameters are accessed from within the dialog window that opens when you click on an icon in the navigation window.
- In general, process parameters are accessed through the Level Transducer Block, and device parameters are accessed through the Resource Block.

Pull-down menu access

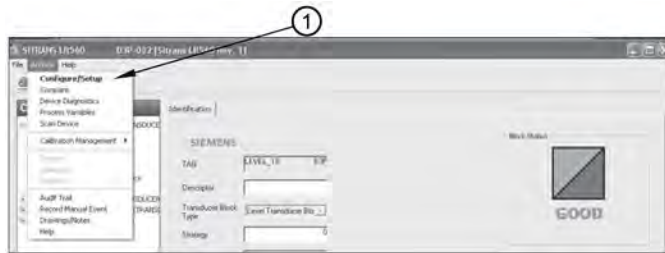

① Action menu items

A pull-down menu under Actions provides alternative access to several features.

Changing parameter settings

Note

- For a complete list of parameters accessible via AMS, see AMS menu structure (Page 97).
- For parameters followed by a reference number, additional information is available in Parameter Reference (Page 108).

1. Modify parameter values in the parameter value field in **Configure/Setup** view, then click **Apply** to write the new values to the device. (The Apply button is activated when a parameter is modified.) The parameter field will display in yellow until the value has been written to the device.
2. Click **OK** if you wish to update all parameters and exit to Device Connection View. Click **CANCEL** to exit without saving changes.

7.1.1.3 Adding a new device

Electronic Device Description (EDD)

Note

SITRANS LR560 requires the EDD for AMS Device Manager version 9.0.

Check the product page of our website (www.siemens.com/LR560), under **Support > SoftwareDownloads**, for the latest version of EDD: SITRANS LR560 FF - Foundation Fieldbus - AMS V9.0.

1. Check that you have the latest version of the EDD for AMS Device Manager that matches the firmware revision of your device. See FIRMWARE REVISION (2.2.2.) (Page 112) to access it via the local user interface. If necessary download the EDD from the product page listed above.
2. Save the files to your computer, and extract the zipped file to an easily accessed location.

3. Launch **AMS Device Manager – Add Device Type**, browse to the unzipped EDD file and select it.
4. If desired, enter a new device tag. The device is shipped with a unique tag, consisting of a manufacturer id and serial number¹⁾. It is not necessary to change the device tag to make the device operational.

To change Device Tag:

Launch **AMS Device Manager – AMS Device Manager**.

- From Device Connection View, right click on the FF Network icon and select **Rebuild Hierarchy**.
- Right click on the device icon, and choose **Rename** from the menu.
- Enter a device tag and press **Enter**.

¹⁾ The device tag is read-only via local operation.

Note

The Device Tag described above is distinct from the Tag that describes each block type (located in the *Identification* folder of each block).

Startup

1. Launch AMS Device Manager

1. Launch **AMS Device Manager– AMS Device Manager**.
2. From Device Connection View, right click on the FF Network icon and select **Rebuild Hierarchy**.
3. If you wish to rename the device, right-click on the device icon and select **Rename** from the menu, enter a new device tag, and click **Enter**.
4. Double-click the device icon. The **Configure/Setup** menu opens at the device Identification dialog window. At initial startup, the Block Status is Out of Service.

2. Master Reset

Note

- We recommend performing a Master Reset before configuring a new device.
- RESOURCE and LTB Blocks must be in Out of Service Mode before a Master Reset can be performed.

1. Navigate to **Configure/Setup > Resource Block > Operation** and click **Methods** to open the dialog window.
2. In the **General** field, click **Master Reset** then click **Next** to perform a reset to factory defaults. Click **Next** to accept the default reset to **Factory Defaults**.

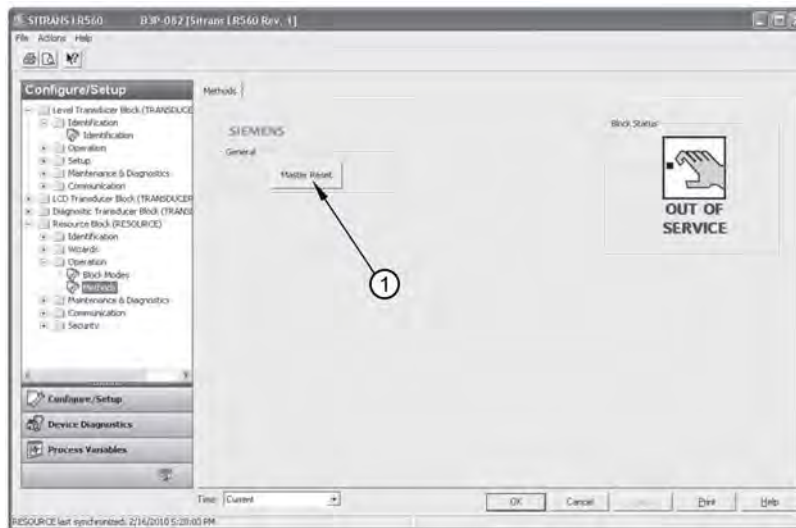

① Master Reset

3. Click **FINISH**, then scan the device (see step 3).
4. After a master reset to factory defaults is performed, the device will reset and the LCD will display the Quick Start Wizard until the device is configured.

3. Scan Device

Scan Device uploads parameters from the device to AMS Device Manager. This synchronizes parameters between the device and AMS.

1. From the menu bar, open the pull-down menu **Actions – Scan Device**.
2. If you are adding a new device, configure the device via the Quick Start wizard.

7.1.1.4 Configuring a new device

Note

- The LR560 FF is shipped with RESOURCE and LTB blocks in Out of Service mode.
 - If you complete the Quick Start Wizard via local operation the first time it is used, it will automatically put the RESOURCE and LTB blocks into AUTO mode. See Quick Start Wizard via the local display push buttons (Page 40).
 - Except for the first time it is used, after completing the Quick Start wizard via local operation, you must manually put the RESOURCE and LTB blocks into AUTO mode.
 - After completing the Quick Start Wizard via AMS, you must manually put the RESOURCE and LTB blocks into AUTO mode.
-

Configure a new device using the Quick Start Wizard. The Quick Start Wizard provides an easy step-by-step procedure that configures the device for a simple application.

Please consult the operating instructions or online help for details on using AMS Device Manager.

Quick Start Wizard steps

Note

- When performing a Quick Start via AMS, the Resource and LTB blocks must be in **Out of Service mode** before any configuration changes¹⁾ can be written, see Changing block modes (Page 64).
 - After completing the Quick Start wizard via AMS, you must manually place the RESOURCE block in **Automatic** mode. This will also change LTB to **Automatic** mode.
 - Values set using the Quick Start Wizard via AMS are saved and recalled each time it is initiated.
-

¹⁾ Changes to parameters that affect the block output.

Launch **AMS Device Manager** and double-click the device icon from Device Connection View to open the startup screen.

Navigate to **Configure/Setup > Resource Block > Wizards > Quick Start**.

- In the navigation window, click on the Quick Start steps in order.
- At each step, if you do not wish to change the default values in the dialog window that opens, click on the icon for the next Quick Start step.
- If you modify a parameter in any step, the **Apply** button is activated. Click **Apply** to write changes to the device.

Step 1 – Identification

Click **Step 1 - Identification**.

If you wish to accept the default values, go directly to Step 2 (**Descriptor**, **Message**, and **Date** fields can be left blank). Or if desired, make changes then click **Apply**.

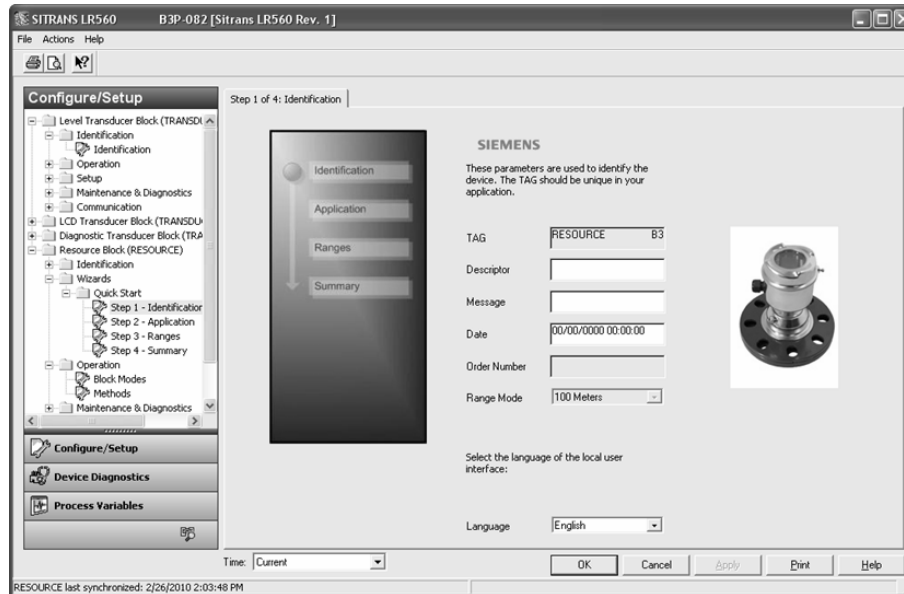

Step 2 – Application

Note

- Selecting either STEEL or CONCRETE does a functional reset, see MASTER RESET (4.1.) (Page 134).
- Selecting STEEL changes the setting for POSITION DETECT (2.4.5.2.) (Page 119) to Rising Edge. **and for** ALGORITHM (2.4.5.1.) (Page 119) to F.
- Selecting CONCRETE changes the setting for POSITION DETECT (2.4.5.2.) (Page 119) to Rising Edge and for ALGORITHM (2.4.5.1.) (Page 119) to ALF.

Click **Step 2 - Application**. If you wish to accept the default values, go directly to Step 3.

Or select a different vessel type (steel or concrete). This changes the setting for POSITION DETECT (2.4.5.2.) (Page 119) to Rising Edge. Then click **Apply**.

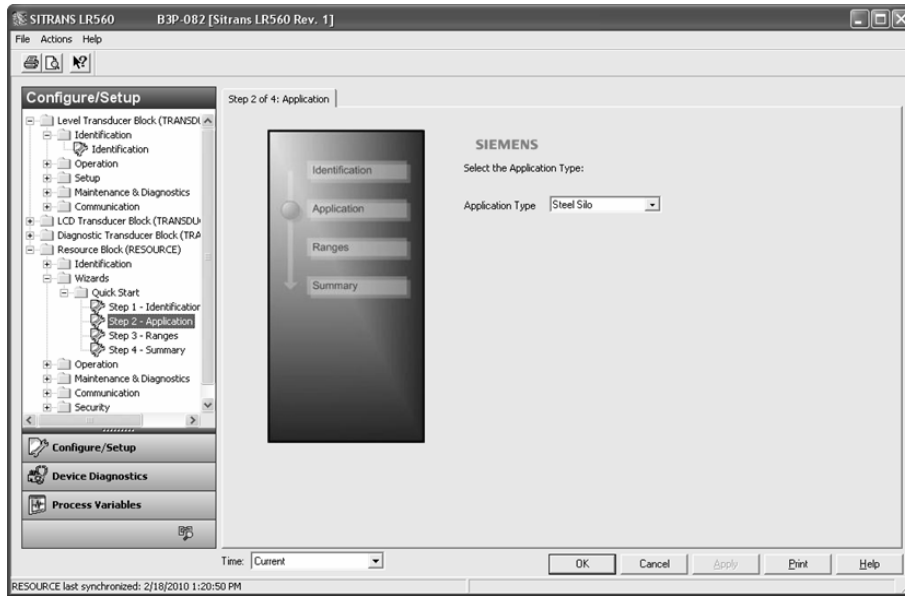

Step 3 – Ranges

Note

Selecting SLOW Response Rate changes setting for AVERAGE AMOUNT (2.8.3.) (Page 131) to 0.9.

Click **Step 3 - Ranges**. If you wish to accept the default values, go directly to step 4. Or make changes as desired, then click **Apply**.

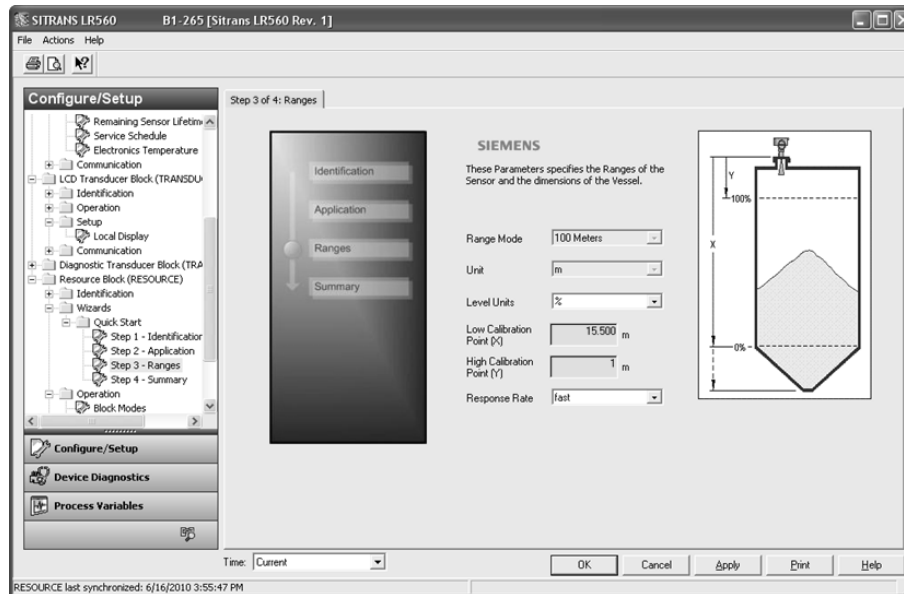

Step 4 – Summary

Click **Step 4 - Summary**. Check parameter settings. Return to individual steps if further changes are necessary.

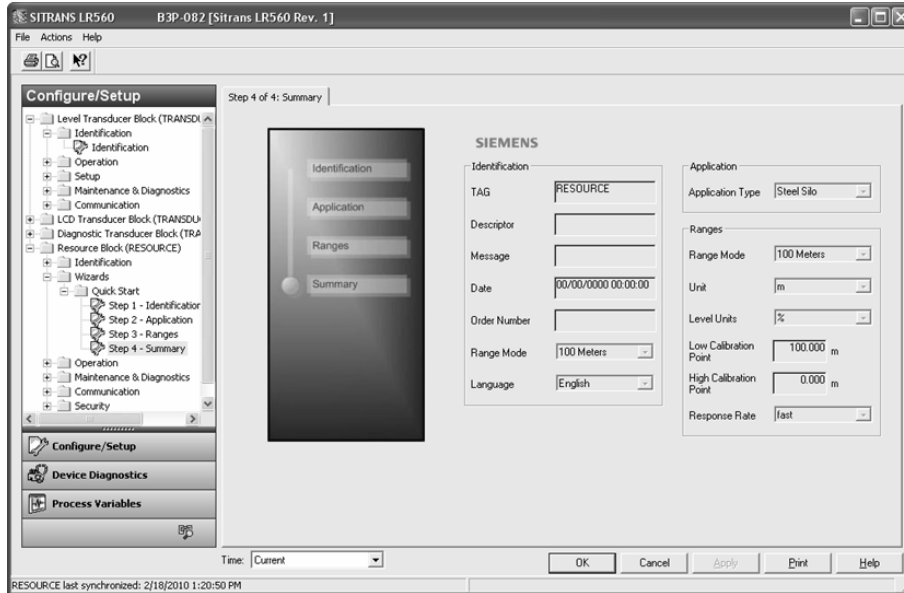

The Quick Start is now complete. Put Resource Block into Automatic Mode, see Changing block modes (Page 64).

7.1.1.5 Changing block modes

Note

Resource Block overrides Level Transducer Block. Changing Resource Block mode will also change Level Transducer Block mode.

To change any block mode follow the same procedure as for changing Resource Block mode.

To change Resource Block mode:

1. Navigate to **Configure/Setup > Resource Block > Operation > Block Mode** and click **Block Mode** to open the dialog window.
2. Select the desired Target mode and deselect the other option. Click **Apply** (the Apply button is activated when a change is made).

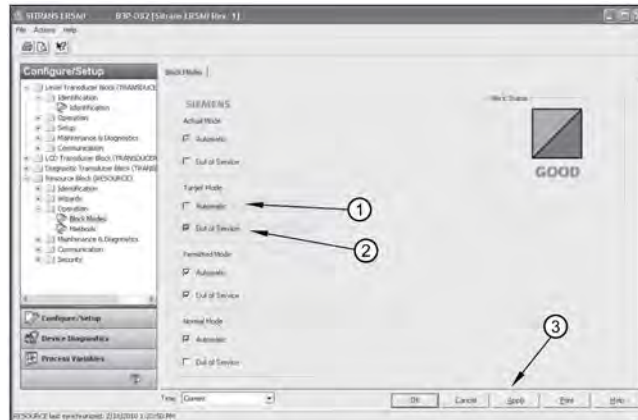

- ① Target Mode deselected
- ② Target Mode selected
- ③ Apply

3. Return to the main menu.

7.1.1.6 Configure/Setup parameters

Transducer Block parameters

Identification and Operation are common to all three Transducer Blocks: Level Transducer Block, LCD Transducer Block, and Diagnostic Transducer Block.

Identification (LTB, LCD, DIAG)

Navigate to **Configure/Setup > LTB** and click **Identification** to open the dialog window for access to:

Identification:

- TAG
Read only. Description for the associated block: device tag prefixed by block type.
- Descriptor
Text that can be used in any way. Limited to 32 ASCII characters. No specific recommended use.
- Transducer Block Type
Read only. Identifies the type of transducer block.
- Strategy
Used to identify grouping of blocks.
- Plant Unit
The identification number of the plant unit. For example, can be used in the host for sorting alarms.

Operation (LTB, LCD, DIAG)

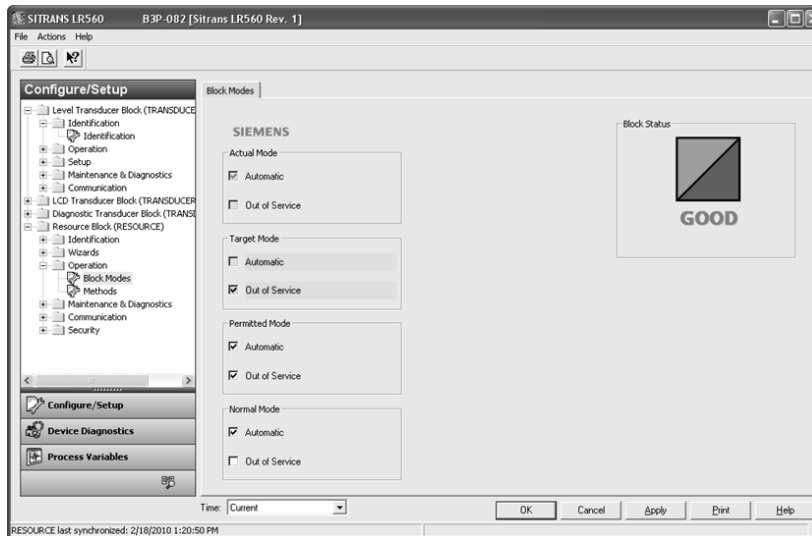

Navigate to **Configure/Setup > LTB > Operation** and click **Block Modes** to open the dialog window for access to block modes:

1. Actual Mode (read only)

This is the current mode of the block, which may differ from the target based on operating conditions. Its value is calculated as part of the block execution.

2. Target Mode

Used to request an operating mode.

3. Permitted Mode

Defines the modes that are allowed. The permitted mode is configured based on application requirements.

4. Normal Mode

This is the mode that the block should be set to during normal operating conditions.

Level Transducer Block parameters

Operation (LTB)

Navigate to **Configure/Setup > LTB > Operation** and click **Simulation** to open the dialog window for access to:

Simulation (Input)

Note

- To activate simulation via AMS Device Manager or the 375 Field Communicator, simulation must also be set to Enabled on the device. See SIMULATE ENABLE (4.12.) (Page 144).
- Before enabling or disabling **Simulation**, put LTB Block into OOS mode (see Changing block modes (Page 64)).
- After changes have been made, LTB must be returned to AUTO mode.

Allows you to simulate the sensor value which is input to the Level Transducer Block. This tests everything between the Level Transducer Block and Output.

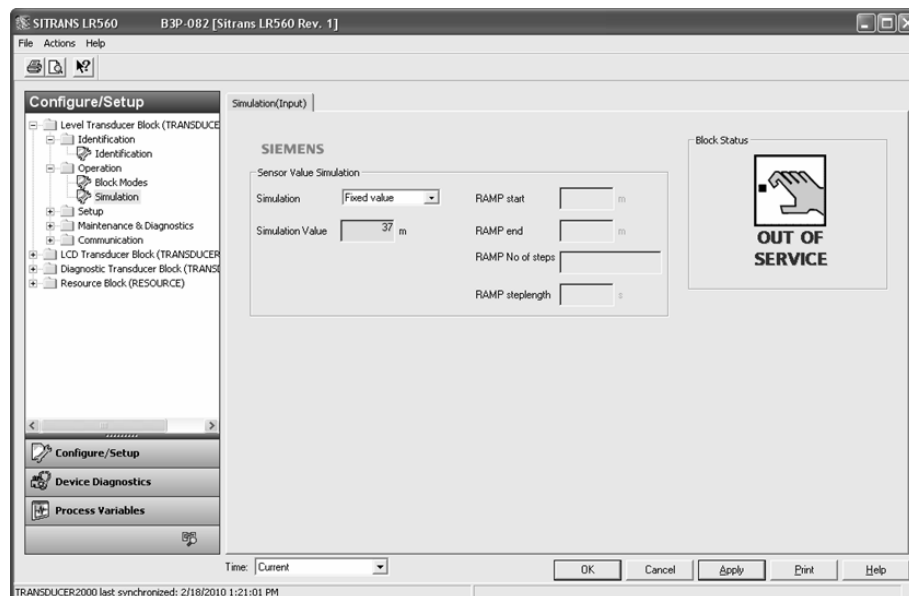

- Simulation
- Simulation Value

Ramp start	Range: -999999 to 999999. Default: 0 m
Ramp end	Range: -999999 to 999999. Default: 0 m
Number of steps	Range: 1 to 65535. Default: 10
Step length	Range: 1 to 65535. Default: 5 s

1. Set Simulation to **Fixed value** or **Ramp**, and click **Apply**.
2. If you select **Fixed value**, enter a Simulation Value and click **Apply**.
3. Or select **Ramp**, enter the RAMP start, end, number of steps, and step length, and click **Apply**.
4. After simulation is complete, set Simulation to **OFF** and click **Apply**.

Setup (LTB)

Note

See AMS menu structure (Page 97) and for parameters followed by a reference number, more detailed descriptions can be found in Parameter Reference (Page 108).

Sensor (LTB)

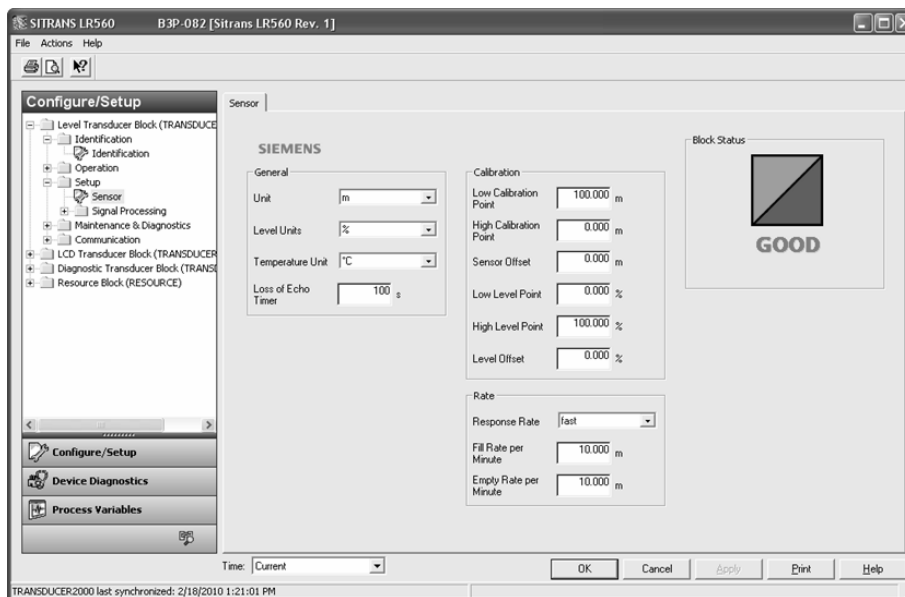

Navigate to **Configure/Setup > LTB > Setup** and click **Sensor** for access to:

General

- Unit
- Level Units
- Temperature Unit
- Loss of Echo Timer

Calibration

- Low Calibration Point
- High Calibration Point
- Sensor Offset
- Low Level Point
- High Level Point
- Level Offset

Rate

Note

Selecting SLOW Response Rate changes setting for AVERAGE AMOUNT (2.8.3.) (Page 131) to 0.9.

- Response Rate
- Fill Rate per Minute
- Empty Rate per Minute

Signal Processing (LTB)

Note

See AMS menu structure (Page 97) and for parameters followed by a reference number, more detailed descriptions can be found in Parameter Reference (Page 108).

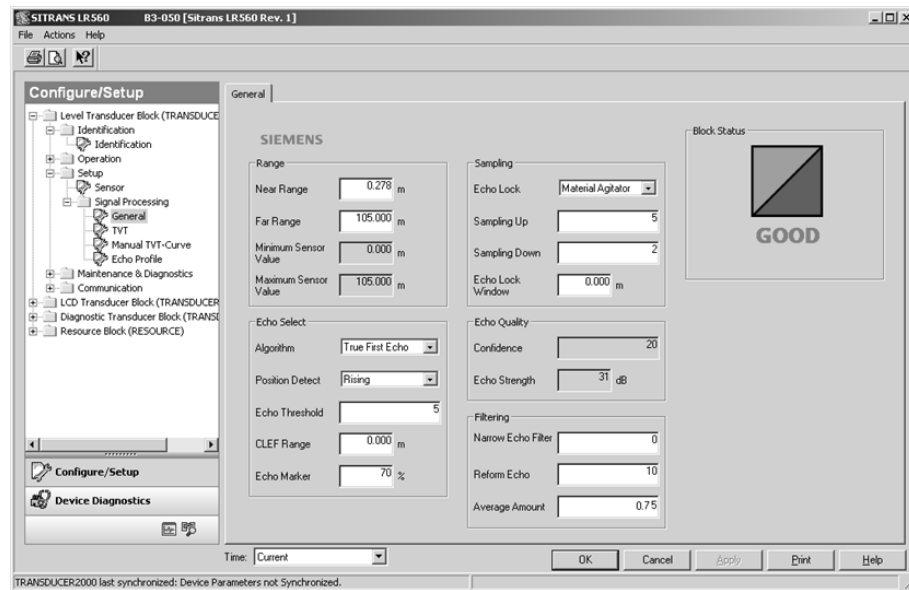

General

Navigate to **Configure/Setup > LTB > Setup > Signal Processing** and click on **General** for access to:

Range

- Near Range
- Far Range
- Minimum Sensor Value
- Maximum Sensor Value

Echo Select

- Algorithm
- Position Detect
- Echo Threshold
- CLEF Range
- Echo Marker

Sampling

- Echo Lock
- Sampling Up
- Sampling Down
- Echo Lock Window

Echo Quality

- Confidence
- Echo Strength

Filtering

- Narrow Echo Filter
- Reform Echo
- Average Amount

TVT

A custom Time Varying Threshold (TVT) allows you to screen out false echoes, for example, in a tank with obstructions. See AUTO ECHO SUPPRESSION (2.4.8.1.) (Page 123) for more information.

There are two options:

- Auto False Echo Suppression automatically calculates the position of the TVT.
- TVT shaper breakpoints allow you to manually modify the TVT

Note

- We recommend using the Auto False Echo Suppression Wizard. See AFES WIZARD (1.2.) (Page 109).
 - Put LTB Block into OOS Mode before changing settings, then back into AUTO mode to display TVT.
-

TVT (Auto False Echo Suppression)

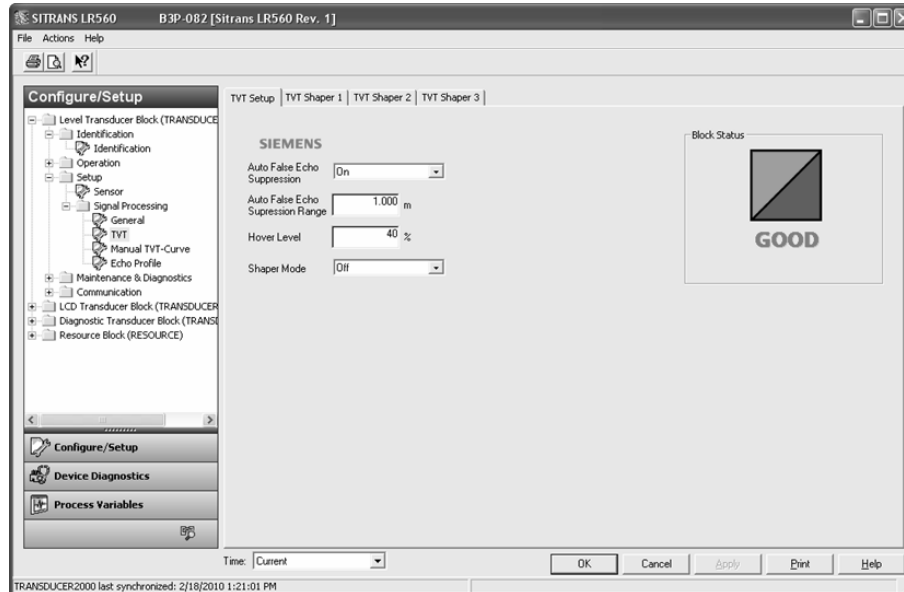

Navigate to **Configure/Setup > LTB > Setup > Signal Processing > TVT**.

TVT Setup

Click **TVT Setup** to access:

- Auto False Echo Suppression
- Auto False Echo Suppression Range
- Hover Level
- Shaper Mode

Allows you to modify breakpoints under the TVT Shaper tabs, and view Manual TVT-Curve.

1. Turn Shaper Mode **On** and turn Auto False Echo Suppression **Off**.
2. Click the appropriate TVT Shaper tab and modify breakpoints as desired.
3. Click **Apply**.

TVT Shaper 1

- Shaper breakpoints 1 to 40

TVT Shaper 2

- Shaper breakpoints 41 to 80

TVT Shaper 3

- Shaper breakpoints 81 to 120

Manual TVT curve

Note

Put LTB Block into OOS Mode before changing settings, then back into AUTO mode to display TVT.

Displays the effects of the TVT shaper modifications. Shaper Mode must be on.

Navigate to **Configure/Setup > LTB > Setup > Signal Processing > Manual TVT-Curve.**

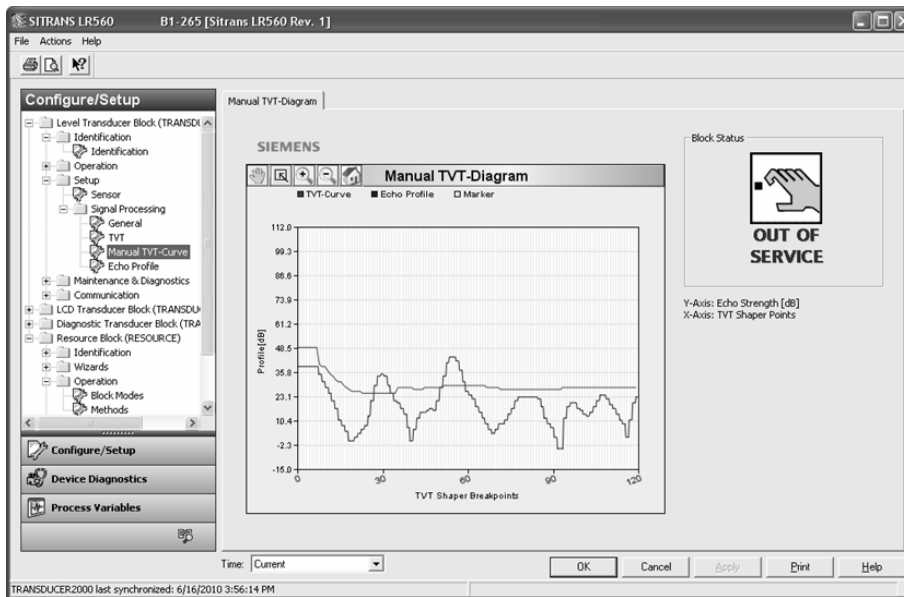

Echo profile

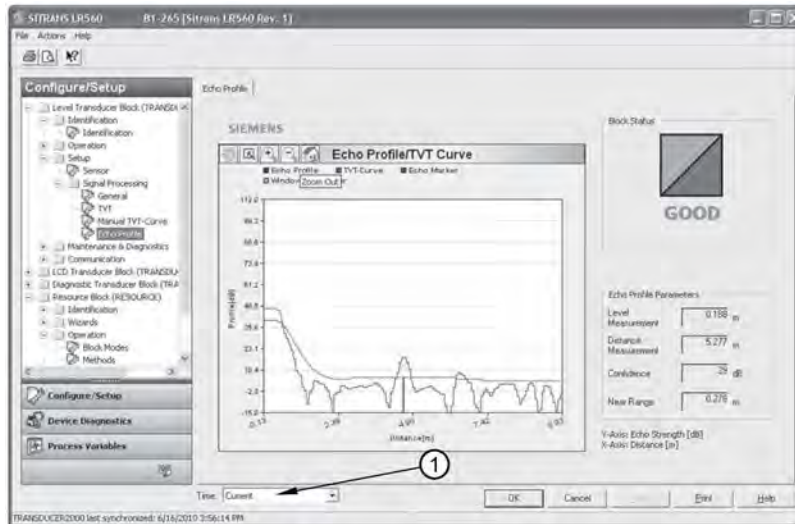

① Time field

Navigate to **Configure/Setup > LTB > Setup > Signal Processing > Echo Profile** to view the current echo profile and to access Echo Profile Parameters (view only).

Echo Profile Parameters (view only)

- Level Measurement
- Distance Measurement
- Confidence
- Near Range

For an illustration showing Level and Distance see CHANNEL (2.5.3.) (Page 127). For an explanation of the use of offsets, see *Level Transducer Block (LTB) on page 6* of Foundation Fieldbus for Level Instruments manual.

To view a previous profile:

Click the drop-down arrow on the **Time** field and select the desired profile (available only if using AMS version 10.1 or later).

Maintenance & Diagnostics (LTB)

Note

Maintenance parameters are listed in AMS menu structure (Page 97). The parameter reference number allows you to locate more detailed information in Parameter Reference (Page 108).

Remaining Sensor Lifetime

Navigate to **Configure/Setup > LTB > Maintenance and Diagnostics > Remaining Sensor Lifetime**.

Sensor Lifetime

Click **Sensor Lifetime** tab for access to:

- Lifetime (Expected)
- Time in Operation
- Remaining Lifetime
- Activation of Reminders
- Reminder 1 before Lifetime (Required)
- Reminder 2 before Lifetime (Demanded)

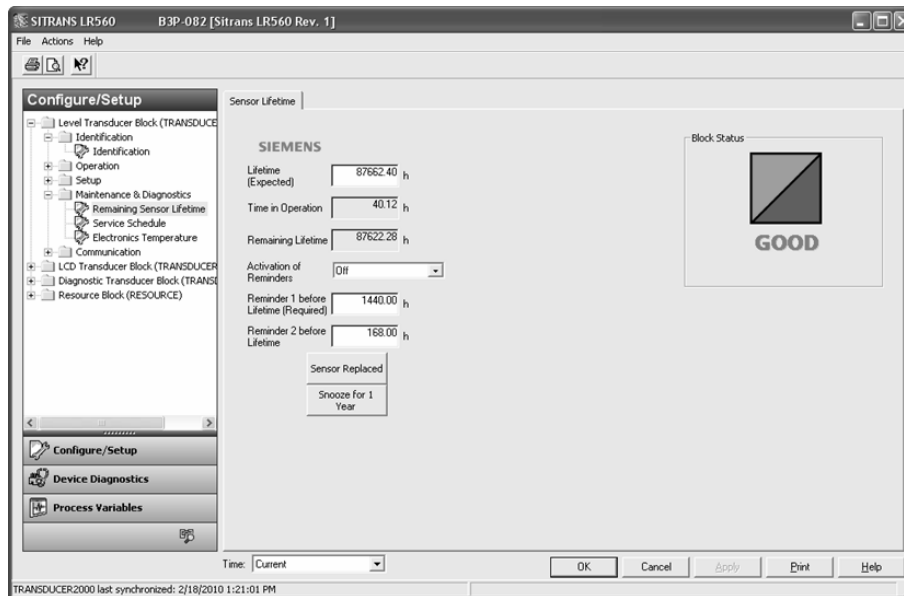

- Click **Sensor Replaced** to reset Time in Operation to 0 hours
- Click **Snooze for 1 Year** to add a year to the Expected Sensor Lifetime.
- Click **Apply** to write changes to the device.

Service Schedule

Navigate to **Configure/Setup > LTB > Maintenance and Diagnostics > Service Schedule**.

Service Schedule

Click **Service Schedule** tab for access to

- Service Interval
- Time Since Last Service
- Time Until Next Service
- Activation of Reminders
- Reminder 1 before Lifetime (Required)
- Reminder 2 before Lifetime (Demanded)

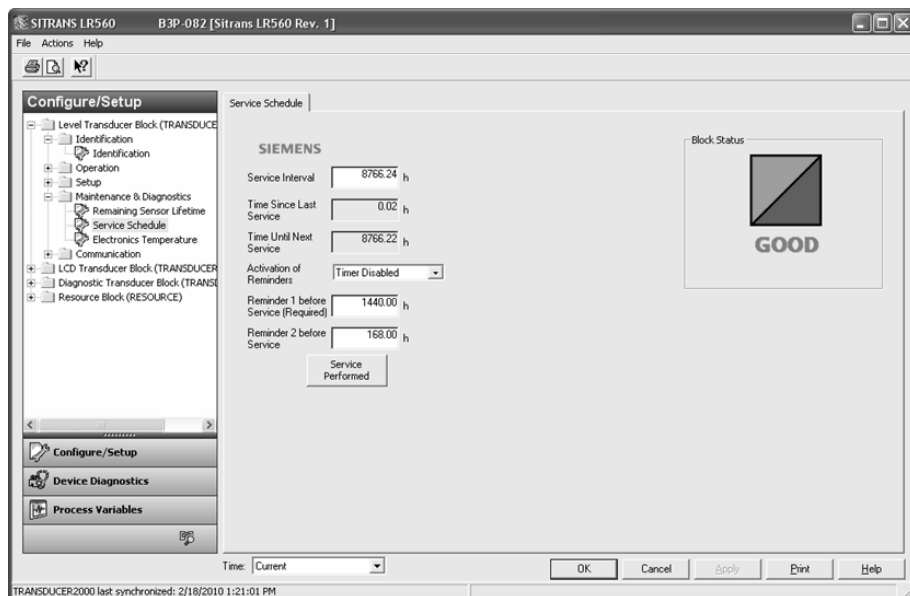

- Click on **Service Performed** to reset Time Since Last Service to 0 hours.
- Click **Apply** to write changes to the device.

Electronics Temperature

- Electronics Temperature
Displays the current internal temperature of the device
- Minimum Value
- Maximum Value

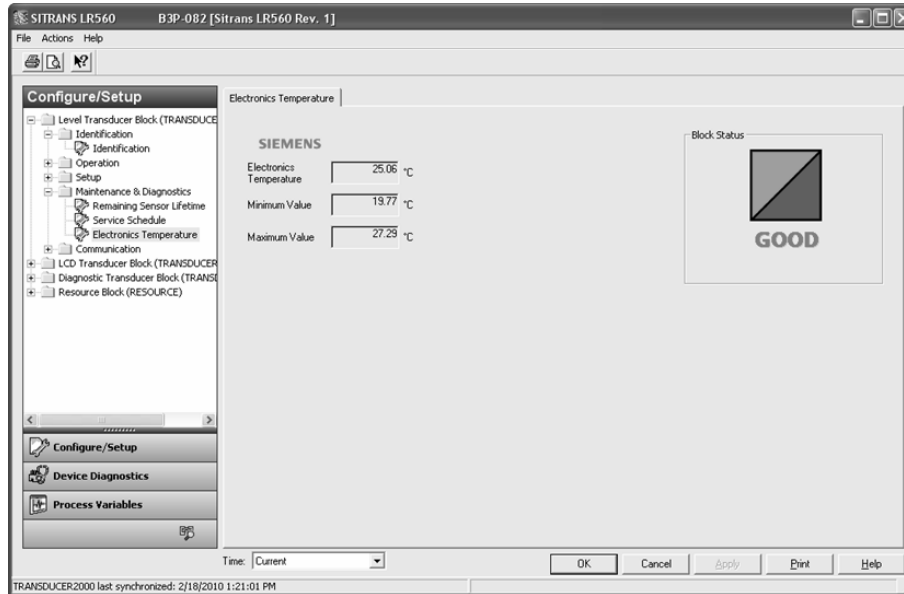

Communication (LTB)

Navigate to **Configure/Setup > LTB > Communication** for access to:

Communication:

- Static Revision No., see STATIC REVISION NO. (2.5.1.) (Page 126)

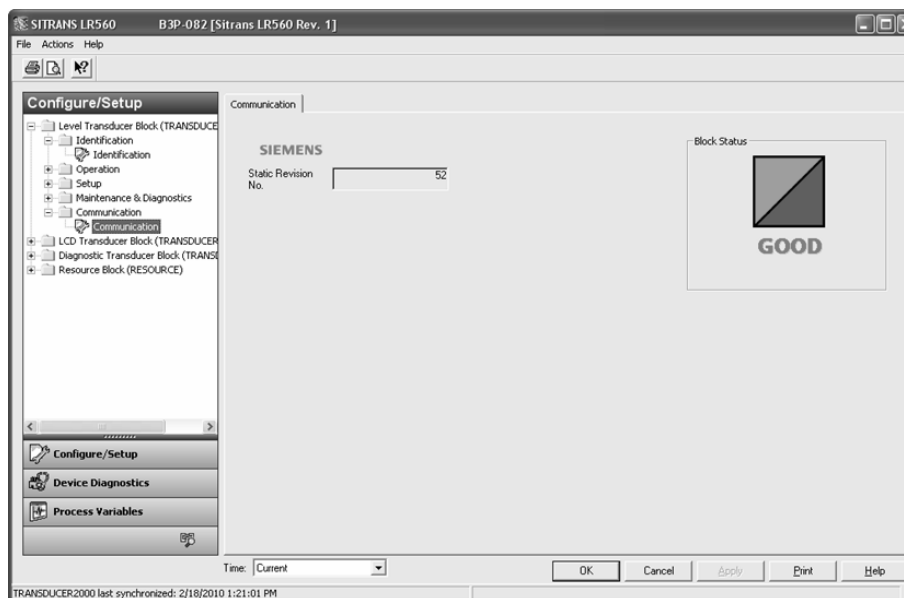

Configure/Setup (LCD Block)

Identification (LCD)

See Identification (LTB, LCD, DIAG) (Page 65).

Operation (LCD)

See Operation (LTB, LCD, DIAG) (Page 66).

Block Modes

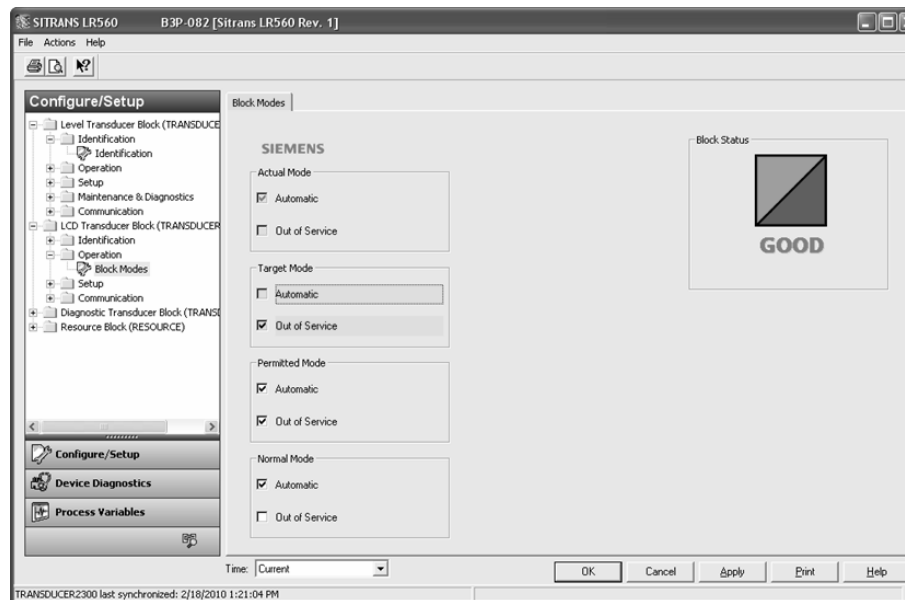

Navigate to **Configure/Setup > LCD > Operation** and click **Block Modes** to open the dialog window for access to:

- Actual Mode (*read only*)
- Target Mode
- Permitted Mode
- Normal Mode

See *Block Modes* under Operation (LTB, LCD, DIAG) (Page 66) for more detail.

To remotely disable updating of the LCD:

LCD Transducer Block must be put into **Out of Service** mode.

1. Select Target Mode **Out of Service** and deselect **Automatic**.
2. Click **Apply**.

Setup (LCD)

Navigate to **Configure/Setup > LCD > Setup** for access to:

Local Display

- Language
- LCD Contrast
- LCD Backlight

Local Display (continued)

- Local Operation

If local operation is disabled remotely and no communication activity exists for 30 seconds, the parameter is made visible again locally.

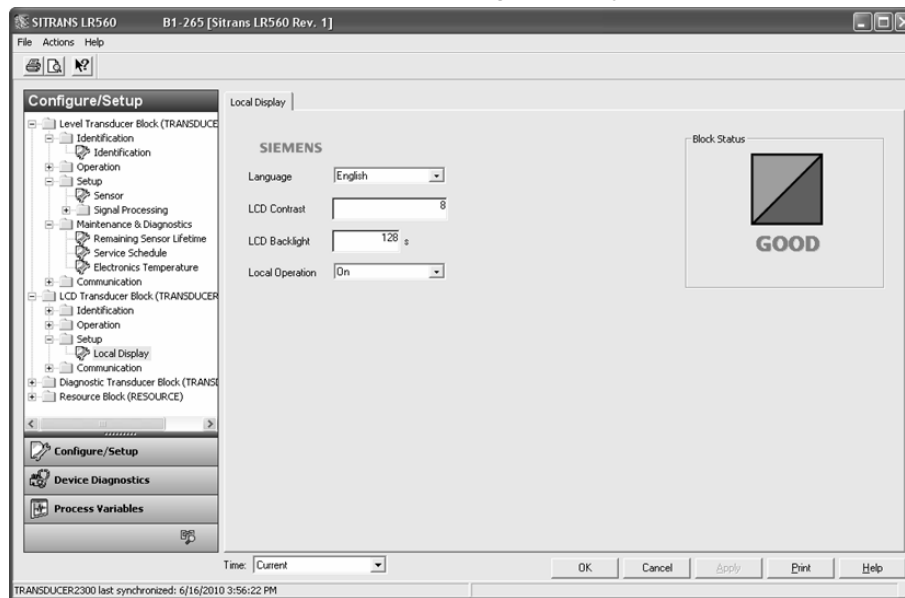

Communication (LCD)

Navigate to **Configure/Setup > LCD > Communication** for access to:

Communication:

- Static Revision no., see STATIC REVISION NO. (2.5.1.) (Page 126)

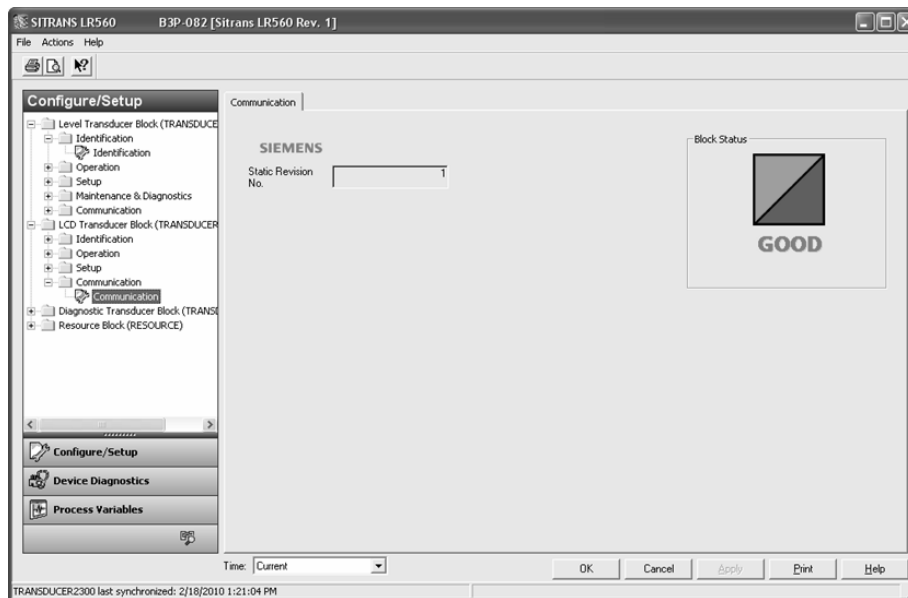

Configure/Setup (Diagnostic Transducer Block-DIAG)

Configure/Setup (Diagnostic Transducer Block-DIAG)

Note

Parameters in the Diagnostic Transducer Block used solely by factory personnel.

Identification (DIAG)

Navigate to **Configure/Setup > DIAG > Identification**.

Identification, see Identification (LTB, LCD, DIAG) (Page 65).

Operation (DIAG)

Navigate to **Configure/Setup > DIAG > Operation**. See Operation (LTB, LCD, DIAG) (Page 66).

Communication (DIAG)

Navigate to **Configure/Setup > DIAG > Communication**.

Communication:

Static Revision No., see STATIC REVISION NO. (2.5.1.) (Page 126).

Configure/Setup (Resource Block-RESOURCE)

Note

- For a complete list of parameters accessible via AMS, see AMS menu structure (Page 97).
 - For parameters followed by a reference number, additional information is available in Parameter Reference (Page 108).
-

Identification (RESOURCE)

Navigate to **Configure/Setup > RESOURCE > Identification** for access to:

Identification

- TAG
Read only. Description for the associated block: device tag prefixed by block type.
- Descriptor
- Message
- Date (Installation Date)
The user entered date on which the device was installed in the system.
- Strategy
Used to identify grouping of blocks.
- Plant Unit
The identification number of the plant unit. For example, can be used in the host for sorting alarms.

Device (read only)

- Manufacturer
- Product Name
The manufacturer's product name for this device.
- Order Number
The manufacturer's order number (MLFB) for this device.
- Range Mode
Measuring range of the device.
- Serial Number
The manufacturer's unique serial number for this device.
- Hardware Revision
- Firmware Revision
- Loader Revision
- EDD Version
Revision of the EDD associated with this device.
- Date of Manufacturing



Wizards (RESOURCE)

Navigate to **Configure/Setup > RESOURCE > Wizards > Quick Start** for access to Quick Start steps. See Quick Start Wizard steps (Page 60).

Operation (RESOURCE)

Navigate to **Configure/Setup > RESOURCE > Operation**.

Click on Block Modes to open the dialog window for access to:

Block Modes

Note

If the RESOURCE block is set to Out of Service, the LTB, and AIFB blocks are forced to Out of Service also, but the LCD and DIAG blocks remain in Automatic mode.

- Actual Mode
- Target Mode
- Permitted Mode
- Normal Mode

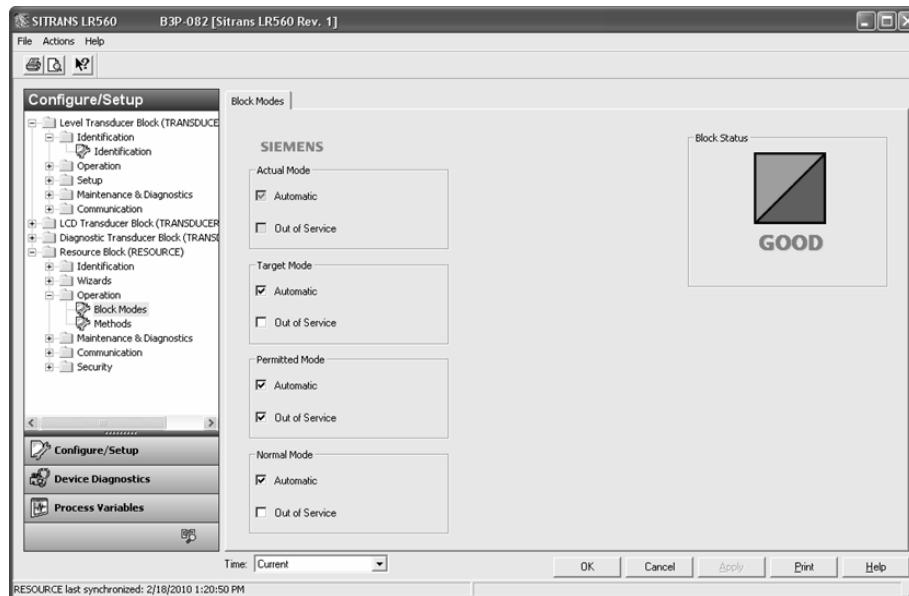

Master reset (RESOURCE)

Click **Methods** to open the dialog window for access to:

Master Reset

Note

- RESOURCE and LTB Block Status must be Out of Service before a Master Reset can be performed. See Changing block modes (Page 64).
 - The following parameters are not reset by any reset type: Write Protection, Auto False Echo Suppression Range, Learned TVT.
 - While an FF Object Dictionary Reset is in progress, the Master Reset Parameter View showing PREVIOUS/NEXT/BACK/EDIT options will be displayed. Do not perform an action using the local display interface until the reset is complete¹⁾. This could cause a temporary loss of communications.
-

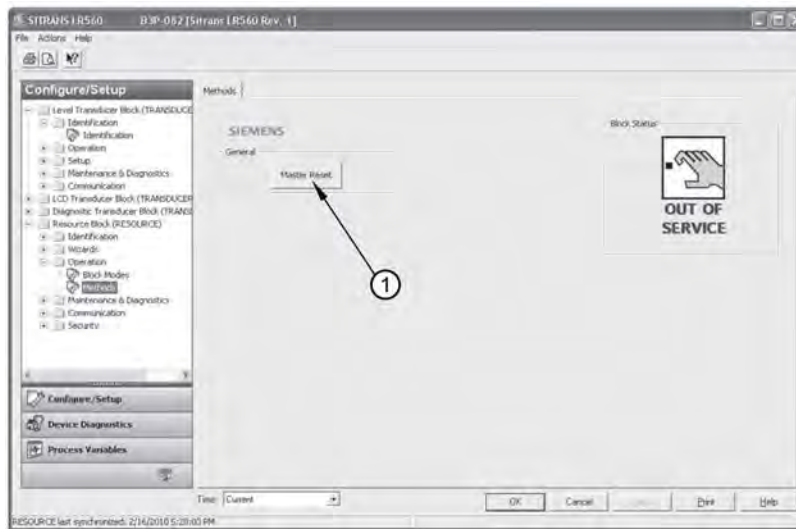

① Master Reset

1. Click the Master Reset button, then click **Next** to perform a reset.
2. Select the Reset Type:

Reset Type	Result
Factory Defaults ^{a)}	Default. Resets all user parameters to the manufacturer's default settings. Following this type of reset, complete reprogramming is required.
Informational	Resets parameters such as Block Descriptor, Strategy, Device Install Date, Device Message.
Functional ^{a)}	Resets parameters that control device behavior and functionality (such as Low Calibration Point).
Warm Start	Has the same effect as recycling power to the device.
FF Object Dictionary ^{b)}	Resets all user parameters except for calibration to Factory Defaults. This option also clears any function block parameters and device schedule ^{c)} set by the user.

a) The only difference between Factory Defaults and Functional reset is that Factory Defaults resets maintenance parameters, such as device and sensor wear, calibration and maintenance timers. Functional reset does not reset these parameters.

b) FF Object Dictionary reset completes with an automatic power cycle.

c) See the manual Foundation Fieldbus for Level instruments (7ML19985MP01), Data Transmission, for more details.

3. Click **Next**, then FINISH to complete the Master Reset.

After a master reset is performed, the device will stop measuring, the Resource and Level Transducer Blocks will go to **Out of Service**, and the LCD will display the **Quick Start Wizard** until the device is configured.

Maintenance & Diagnostics (RESOURCE)

Navigate to **Configure/Setup > RESOURCE > Maintenance & Diagnostics** for access to:

Remaining Device Lifetime

- Lifetime (Expected)
 - Remaining Lifetime (*read only*)
 - Time in Operation (*read only*)
 - Activation of Reminders
 - Reminder 1 before Lifetime (Required)
 - Reminder 2 before Lifetime (Demanded)
1. Open the window **Remaining Device Lifetime**

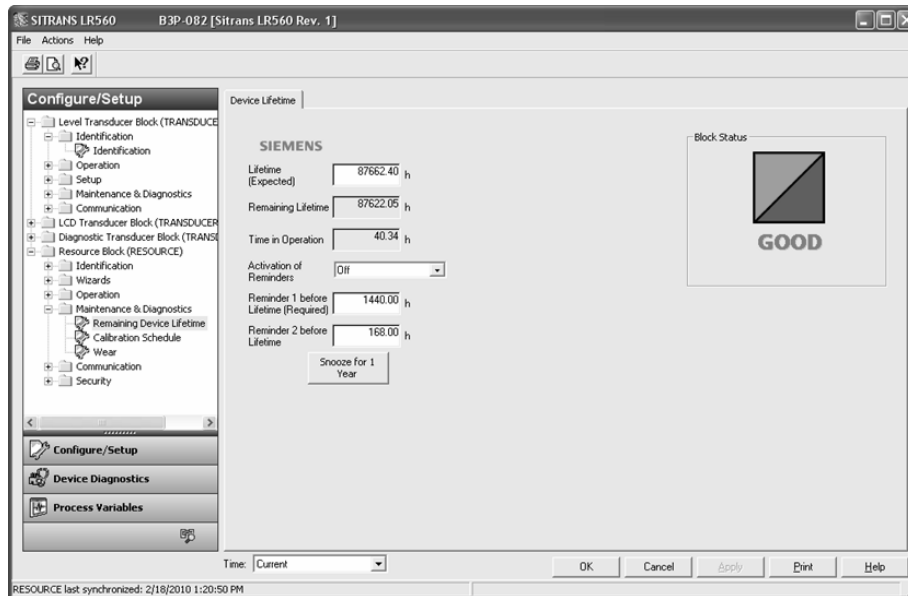

2. After modifying values/units as required, click **Apply** to accept the change.
3. Click on **Snooze for 1 Year** to add a year to the Total Expected Device Life

Calibration Schedule

- Calibration Interval
- Time Since Last Calibration
- Time Until Next Calibration
- Activation of Reminders
- Reminder 1 before Calibration (Required)
- Reminder 2 before Calibration (Demanded)

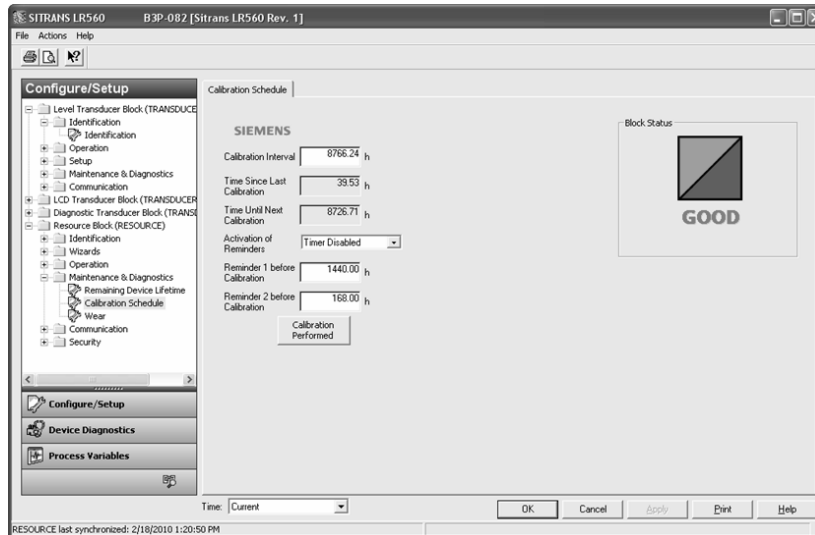

Click on **Calibration Performed** to reset Time Since Last Calibration to 0 hours. Click **Apply** to accept the change.

Wear

- Powered Days (*read only*)
- Power-on resets (*read only*)

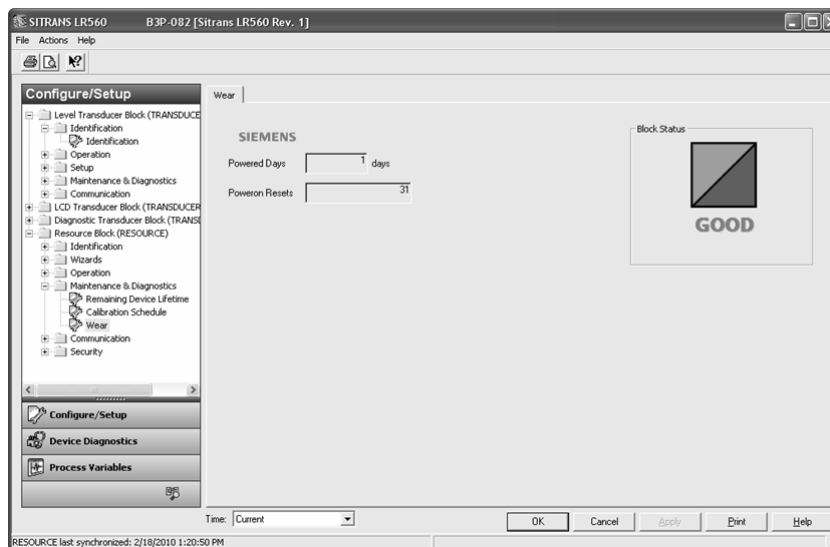

Communication (RESOURCE)

Navigate to **Configure/Setup > RESOURCE > Communication** to read the following:

- Manufacturer
- Device Type

Manufacturer's model number associated with the device

- Device Revision
- DD Revision

Revision of the DD (also called EDD) associated with this device.

- ITK Version
- Static Revision No.

See **STATIC REVISION NO. (2.5.1.) (Page 126)**

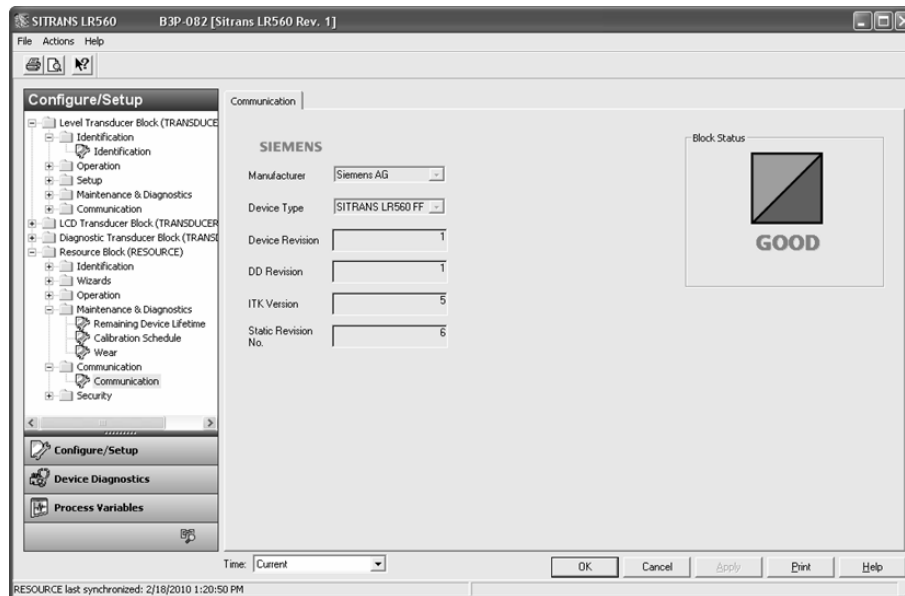

Security (RESOURCE)

Navigate to **Configure/Setup > RESOURCE > Security** to access:

Security

- Write Protection

See also Password Protection (Page 95).

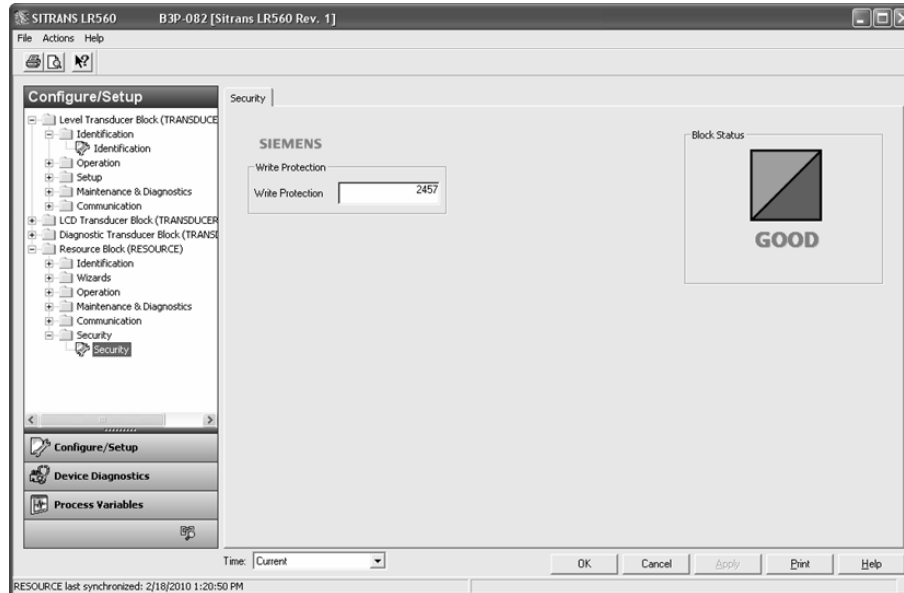

Device diagnostics (Level Transducer Block-LBT)

Note

For explanations of the alarms and errors listed below, see Parameter Description charts for the respective block in the manual *Foundation Fieldbus for Level instruments (7ML19985MP01)*.

Alarms & Errors (LTB)

Navigate to **Device Diagnostics > LTB > Alarms & Errors**.

Block Error

Click on **Block Error** to open the dialog window to read the following:

Failures

- Input Failure
- Output Failure
- Memory Failure
- Lost Static Data
- Lost Non-Volatile Data
- Readback Check
- Device Fault State
- Block Configuration
- Link Configuration
- Other

Maintenance

- Maintenance Required
- Maintenance Demanded

Information

- Simulation Active
- Local Override
- Power Up
- Out of Service

XD Error

- Transducer Error

Block Alarm

Click on **Block Alarm** to open the dialog window to read the following:

Unacknowledged

- Unacknowledged

Alarm State

- Alarm State

Subcode

- Subcode

Value

- Value

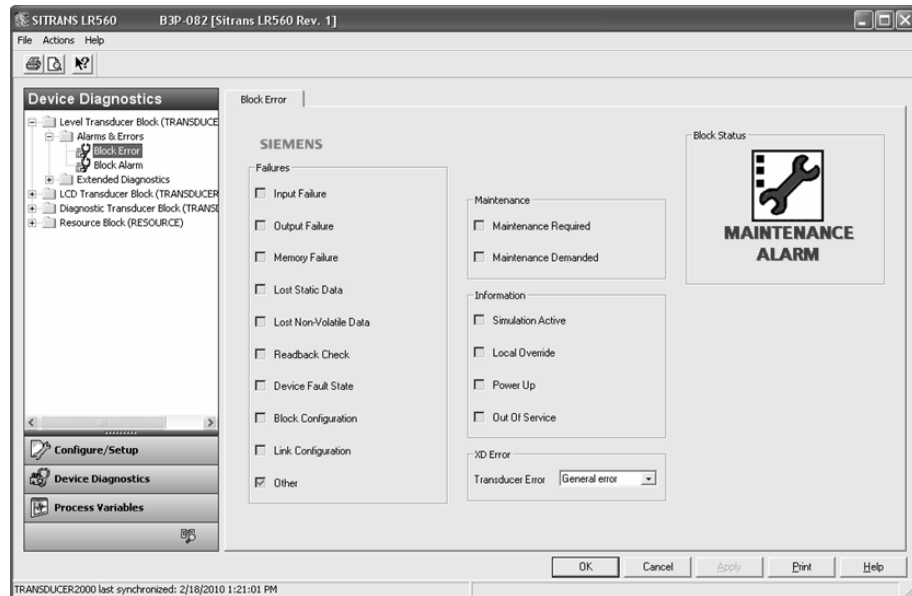

1. From the **Block Error** tab, check the Maintenance window to display the level of maintenance alarm that is active.
2. From the **Block Alarm** tab, check the **Alarm State** window to display the level of maintenance alarm that has been acknowledged.
3. From the **Block Alarm** tab, in the **Unacknowledged** window, select **Acknowledged** to acknowledge an alert.

Note

Acknowledging a maintenance reminder from the device [see ACKNOWLEDGE (4.2.9.) (Page 137), ACKNOWLEDGE (4.3.9.) (Page 139), ACKNOWLEDGE (4.4.9.) (Page 141), ACKNOWLEDGE (4.5.9.) (Page 143)], will not set the Block Alarm to *Acknowledged* in AMS. The maintenance alarm will cause an FF block alert, and the block alert can only be acknowledged via a remote host such as NI-FBUS-Configurator or AMS Device Manager (as in step 3 above).

Extended Diagnostics (LTB)

Navigate to **Device Diagnostics > LTB > Extended Diagnostics** to read the following:

Detailed Error Info

- Loss of Echo
- No Tech Power
- Sensor Lifetime Reminder 1
- Sensor Lifetime Reminder 2
- Service Schedule Reminder 1
- Service Schedule Reminder 2
- LTB Scale
- Internal Temperature Sensor
- Internal Temperature High
- Internal Temperature Calibration
- Velocity Calibration
- Transducer Temperature Sensor
- Transducer Temperature High
- Transducer Temperature Low

Device diagnostics (Level Control Device Block-LCD)

Alarms & Errors (LCD)

Navigate to **Device Diagnostics > LCD > Alarms & Errors** to read Block and Alarm errors.
[Errors displayed are the same for each block (LTB, LCD, DIAG, RESOURCE). See Alarms & Errors (LTB) (Page 87) for full listing.]

Device Diagnostics (Diagnostic Transducer Block-DIAG)

Alarms & Errors (DIAG)

Navigate to **Device Diagnostics > DIAG > Alarms & Errors** to read Block and Alarm errors.
[Errors displayed are the same for each block (LTB, LCD, DIAG, RESOURCE). Alarms & Errors (LCD) (Page 90) for full listing. See AMS Device Manager instruction manual to work with alarms and errors.]

Device Diagnostics (Resource Block-RESOURCE)

Alarms & Errors (RESOURCE)

Navigate to **Device Diagnostics > RESOURCE > Alarms & Errors**.

Block Error

Click **Block Error** tab to read:

Failures

- Input Failure
- Output Failure
- Memory Failure
- Lost Static Data
- Lost Non-Volatile Data
- Readback Check
- Device Fault State
- Block Configuration
- Link Configuration
- Other

Maintenance

- Maintenance Required
- Maintenance Demanded

Information

- Simulation Active
- Local Override
- Power Up
- Out of Service

Block Alarm

Click **Block Alarm** tab to read:

Unacknowledged

- Unacknowledged

Alarm State

- Alarm State

Subcode

- Subcode

Value

- Value

Write Alarm

Values available on **Block Alarm** tab are also available for **Write Alarm** with one exception: the Value parameter on the Write Alarm tab is a **Discrete Value**.

Alarm Summary

Click on **Alarm Summary** tab to open the dialog window to read:

Current

- Discrete Alarm
- Block Alarm

Unacknowledged

- Discrete Alarm Unacknowledged
- Block Alarm Unacknowledged

Unreported

- Discrete Alarm Unreported
- Block Alarm Unreported

Disabled

- Write Alarm Disabled
- Block Alarm Disabled

Alarm Summary (continued)

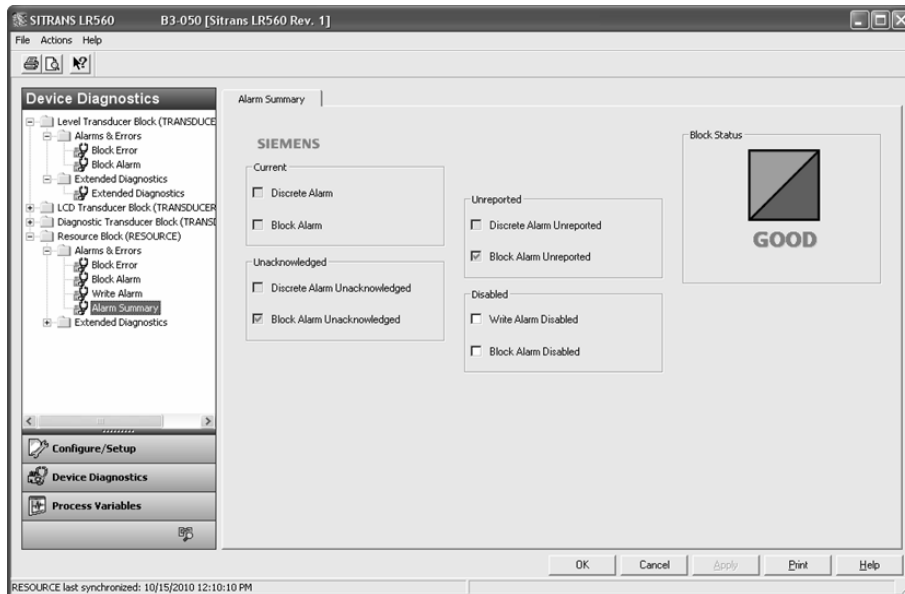

Extended Diagnostics (RESOURCE)

Navigate to **Device Diagnostics > RESOURCE > Extended Diagnostics** to read:

Detailed Error Info

- Device Lifetime Reminder 1
- Device Lifetime Reminder 2
- Calibration Schedule Reminder 1
- Calibration Schedule Reminder 2
- Internal Error
- External RAM
- Memory RAM
- Memory EEPROM
- Memory EEPROM Flags
- Memory Flash
- Invalid Loader

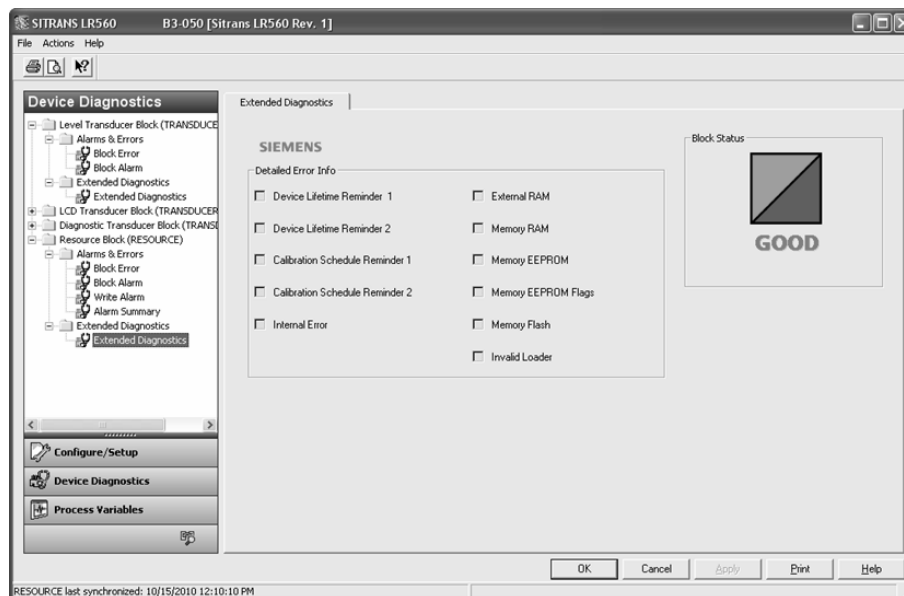

Process Variables (Level Transducer Block - LTB)

To compare outputs in real time navigate to **Process Variables > LTB > Process Variables**.

Values

Click **Values** tab to view:

- Primary Variable

View a chart showing level value.

- Value

The primary variable and the channel 1 output from the transducer block as a number.

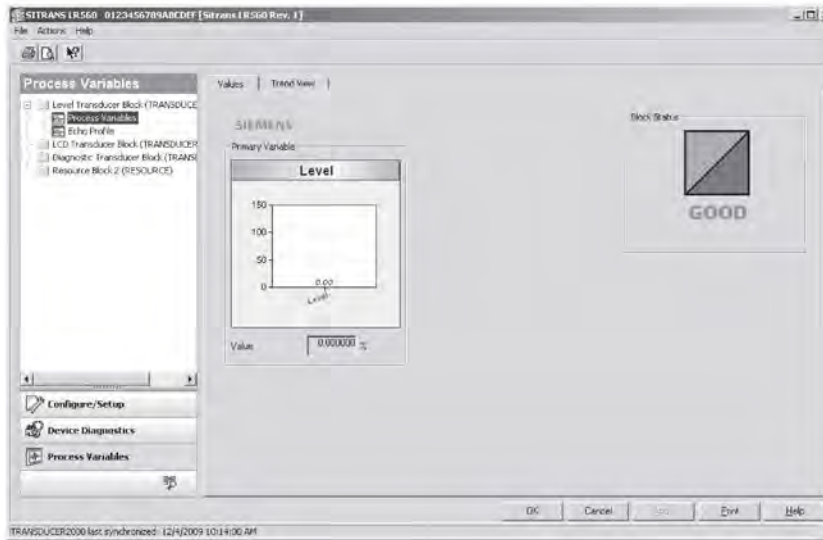

For level applications, chart range is affected by High and Low Level Point values set in **Configure/Setup > LTB > Setup > Sensor**.

Trend View

Click **Trend View** tab to view:

- Trend Values
- Trend View

The primary variable and the channel 1 output from the transducer block.

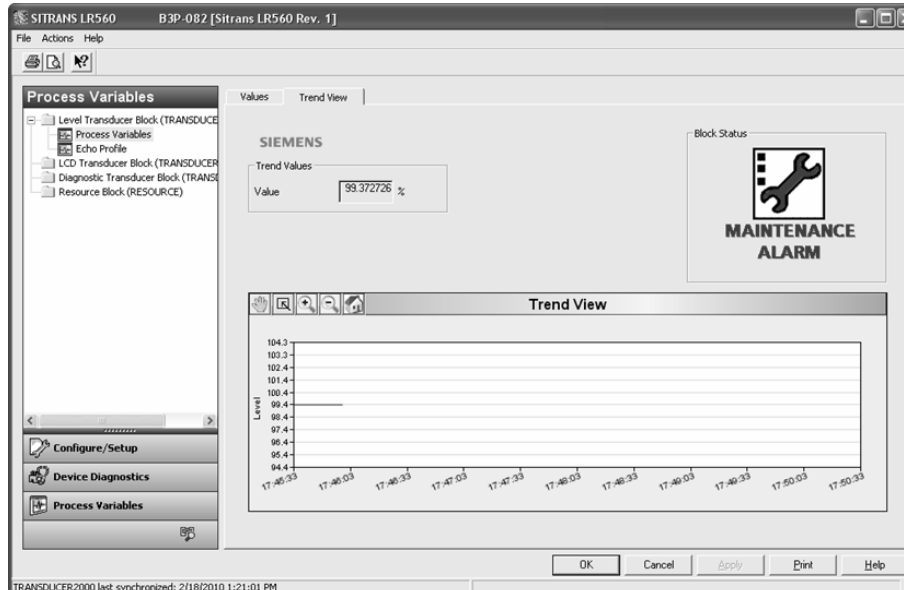

Echo Profile

Click **Echo Profile** to read:

Echo Profile Parameters

- Level Measurement
- Distance Measurement
- Confidence
- Near Range

7.1.1.7 Password protection

Password Protection

An AMS Device Manager administrator can configure the user to require a password. The use of passwords is recommended. A password should be assigned to the 'admin' username immediately after installing AMS Device Manager.

Each user is given an AMS Device Manager username and password and required to enter them when they start AMS Device Manager. Access to functions depends on the level of permissions granted.

Login types

- standard, local, or domain

A standard user can change their password in AMS Device Manager. A Local or Domain Windows user cannot change their password using AMS Device Manager and must request their network administrator to do so.

User Manager utility

Username, passwords, and permissions, are assigned to users by an AMS Device Manager administrator, using the User Manager utility on the Server Plus Station. Only a user with AMS Device Manager System Administration rights can log in to User Manager.

To configure a new user/edit existing user:

1. From the Windows taskbar select: **Start > AMS Device Manager > User Manager**.
2. In the User Manager window click on **Add User**.

The **Add User Wizard** dialog allows you to:

- select a user type, Standard User (AMS Device Manager) or Window User
- enter the username and password, and set permissions
- edit existing users



7.1.1.8 AMS menu structure

Note

Where a parameter number is listed, more information is available for that parameter in Parameter Reference (Page 108).

Configure/Setup Function Group	Parameter number
Level Transducer Block	
Identification	
Identification	
<i>Identification (tab)</i>	
TAG	
Descriptor	2.1.2. (Page 112)
Transducer Block Type	
Strategy	
Plant Unit	
Operation	
Block Modes	
<i>Block Modes (tab)</i>	
Actual Mode	
Target Mode	
Permitted Mode	
Normal Mode	
Simulation	
<i>Simulation (Input) (tab)</i>	
Sensor Value Simulation	
Simulation	
Simulation value	
RAMP start	
RAMP end	
RAMP No. of step	
RAMP step length	
Setup	
Sensor	
2.3. (Page 113)	
<i>Sensor (tab)</i>	
General	
Unit	2.3.1. (Page 113)
Level Units	2.3.2. (Page 113)
Temperature Unit	2.3.3. (Page 113)
Loss of Echo Timer	2.3.4. (Page 114)

Calibration	2.3.5. (Page 114)
Low Cal. Point	2.3.5.1. (Page 114)
High Cal. Point	2.3.5.2. (Page 114)
Sensor Offset	2.3.5.3. (Page 115)
Low Level Point	2.3.5.4. (Page 115)
High Level Point	2.3.5.5. (Page 115)
Level Offset	2.3.5.6. (Page 115)
Rate	2.3.6. (Page 116)
Response Rate	2.3.6.1. (Page 116)
Fill Rate per Minute	2.3.6.2. (Page 116)
Empty Rate per Minute	2.3.6.3. (Page 117)
Signal Processing	2.4. (Page 117)
General	
<i>General (tab)</i>	
Range	
Near Range	2.4.1. (Page 117)
Far Range	2.4.2. (Page 118)
Min. Sensor Value	2.4.3. (Page 118)
Max. Sensor Value	2.4.4. (Page 119)
Echo Select	2.4.5. (Page 119)
Algorithm	2.4.5.1. (Page 119)
Position Detect	2.4.5.2. (Page 119)
Echo Threshold	2.4.5.3. (Page 120)
CLEF Range	2.4.5.4. (Page 120)
Echo Marker	2.4.5.5. (Page 121)
Sampling	2.4.6. (Page 121)
Echo Lock	2.4.6.1. (Page 121)
Sampling Up	2.4.6.2. (Page 121)
Sampling Down	2.4.6.3. (Page 121)
Echo Lock Window	2.4.6.4. (Page 122)
Echo Quality	2.4.7. (Page 122)
Confidence	2.4.7.1. (Page 122)
Echo Strength	2.4.7.2. (Page 122)
TVT	2.4.8. (Page 123)
<i>TVT Setup (tab)</i>	
Auto False Echo Suppression	2.4.8.1. (Page 123)
Auto False Echo Suppression	2.4.8.2. (Page 125)
Range	
Hover Level	2.4.8.3. (Page 125)
Shaper Mode	2.4.8.4. (Page 125)
<i>TVT Shaper 1 (tab)</i>	2.4.9. (Page 125)

Breakpoints 1-40	
<i>TVT Shaper 2 (tab)</i>	
Breakpoints 41 - 80	
Level Transducer Block (continued)	
<i>TVT Shaper 3 (tab)</i>	
Breakpoints 81 -120	
Manual TVT-Curve	
<i>Manual TVT-Diagram (tab)</i>	
Maintenance & Diagnostics	
Remaining Sensor Lifetime	4.3. (Page 137)
<i>Sensor Lifetime (tab)</i>	
Lifetime (Expected)	4.3.1. (Page 137)
Time in Operation	4.3.2. (Page 137)
Remaining Lifetime	4.3.3. (Page 138)
Activation of Reminders	4.3.4. (Page 138)
Reminder 1 before Lifetime (Required)	4.3.5. (Page 138)
Reminder 2 before Lifetime (Demand- ed)	4.3.6. (Page 138)
Service Schedule	4.4. (Page 139)
<i>Service Schedule (tab)</i>	
Service Interval	4.4.1. (Page 139)
Time Since Last Service	4.4.2. (Page 139)
Time Until Next Service	4.4.3. (Page 140)
Activation of Reminders	4.4.4. (Page 140)
Reminder 1 before Service (Required)	4.4.5. (Page 140)
Reminder 2 before Service (Demand- ed)	4.4.6. (Page 140)
Electronics Temperature	3.4. (Page 133)
<i>Electronics Temperature (tab)</i>	
Electronics Temperature	
Minimum Value	3.4.1. (Page 133)
Maximum Value	3.4.2. (Page 133)
Communication	
Communication	
<i>Communication (tab)</i>	
Static Revision No.	2.5.1. (Page 126)
LCD Transducer Block	
Identification	
Identification	
<i>Identification (tab)</i>	
TAG	
Descriptor	2.1.2. (Page 112)

	Transducer Block Type	
	Strategy	
	Plant Unit	
Operation		
Block Modes		
<i>Block Modes (tab)</i>		
Actual Mode		
Target Mode		
Permitted Mode		
Normal Mode		
Setup		
Local Display		
<i>Local Display (tab)</i>		
Language		7. (Page 147)
LCD Contrast		4.10. (Page 144)
LCD Backlight		4.9. (Page 143)
Local Operation		
Communication		
Communication		
<i>Communication (tab)</i>		
Static Revision No.		2.5.1. (Page 126)
Diagnostic Transducer Block		
Identification		
Identification		
<i>Identification (tab)</i>		
TAG		
Descriptor		2.1.2. (Page 112)
Transducer Block Type		
Strategy		
Plant Unit		
Operation		
Block Modes		
<i>Block Modes (tab)</i>		
Actual Mode		
Target Mode		
Permitted Mode		
Normal Mode		
Communication		
<i>Communication (tab)</i>		
Static Revision No.		2.5.1. (Page 126)
Resource Block		

Identification

Identification

Identification (tab)

Identification

TAG

Descriptor

2.1.2. (Page 112)

Message

2.1.3. (Page 112)

Date

2.1.4. (Page 112)

Strategy

Plant Unit

Device

Manufacturer

5.3. (Page 145)

Product Name

Order Number

Range Mode

Serial Number

Hardware Revision

2.2.1. (Page 112)

Firmware Revision

2.2.2. (Page 112)

Loader Revision

2.2.3. (Page 112)

EDD Version

Date of Manufacturing

2.2.4. (Page 112)

Wizards

Quick Start

Step 1 - Identification

Step 2 - Application

Step 3 - Ranges

Step 4 - Summary

Operation

Block Modes

Block Modes (tab)

Actual Mode

Target Mode

Permitted Mode

Normal Mode

Methods

Methods (tab)

General

Master Reset

4.1. (Page 134)

Remaining Device Lifetime

4.2. (Page 135)

Device Lifetime (tab)

Lifetime (Expected)

4.2.1. (Page 135)

Remaining Lifetime	4.2.3. (Page 136)
Time in Operation	4.2.2. (Page 136)
Activation of Reminders	4.2.4. (Page 136)
Reminder 1 before Lifetime (Required)	4.2.5. (Page 136)
Reminder 2 before Lifetime (Demanded)	4.2.6. (Page 136)
Calibration Schedule	4.5. (Page 141)
<i>Calibration Schedule (tab)</i>	
Calibration Interval	4.5.1. (Page 141)
Time Since Last Calibration	4.5.2. (Page 141)
Time Until Next Calibration	4.5.3. (Page 142)
Activation of Reminders	4.5.4. (Page 142)
Reminder 1 before Calibration (Required)	4.5.5. (Page 142)
Reminder 2 before Calibration (Demanded)	4.5.6. (Page 142)
Wear	
<i>Wear (tab)</i>	
Powered Days	4.6. (Page 143)
Poweron Resets	4.7. (Page 143)
Communication	
Communication	
<i>Communication (tab)</i>	
Manufacturer	5.3. (Page 145)
Device Type ID	
Device Revision	5.5. (Page 145)
DD Revision	
ITK Version	5.6. (Page 145)
Static Revision No.	2.5.1. (Page 126)
Security	
Security	
<i>Security (tab)</i>	
Write Protection	
Write Protection	6.2.1. (Page 146)
Device Diagnostics Function Group	
Level Transducer Block	
Alarms & Errors	
Block Error	
<i>Block Error (tab)</i>	
Failures	

- Input Failure
- Output Failure
- Memory Failure
- Lost Static Data
- Lost Non-Volatile Data
- Readback Check
- Device Fault State
- Block Configuration
- Link Configuration
- Other

Maintenance

- Maintenance Required
- Maintenance Demanded

Information

- Simulation Active
- Local Override
- Power Up
- Out Of Service

XD Error

- Transducer Error

Block Alarm

Block Alarm (tab)

- Unacknowledged
- Alarm State
- Subcode
- Value

Extended diagnostics

Extended Diagnostics

Extended Diagnostics (tab)

- Detailed Error Info
 - Loss of Echo
 - No Tech Power
 - Sensor Lifetime Reminder 1
 - Sensor Lifetime Reminder 2
 - Service Schedule Reminder 1
 - Service Schedule Reminder 2
 - LTB Scale
 - Internal Temp Sensor

Level Transducer Block (continued)

- Detailed Error Info (continued)
 - Internal Temp High

Internal Temperature Calibration
Velocity Calibration
Transducer Temperature Sensor
Transducer Temperature High
Transducer Temperature Low

LCD Transducer Block

Alarms & Errors

Block Error

Block Error (tab)

Failures

Input Failure
Output Failure
Memory Failure
Lost Static Data
Lost Non-Volatile Data
Readback Check
Device Fault State
Block Configuration
Link Configuration
Other

Maintenance

Maintenance Required
Maintenance Demanded

Information

Simulation Active
Local Override
Power Up
Out Of Service

XD Error

Transducer Error

Block Alarm

Block Alarm (tab)

Unacknowledged
Alarm State

LCD Transducer Block (continued)

Block Alarm (tab) continued

Subcode
Value

Diagnostic Transducer Block

Alarms & Errors

Block Error

Block Error (tab)

Failures

- Input Failure
- Output Failure
- Memory Failure
- Lost Static Data
- Lost Non-Volatile Data
- Readback Check
- Device Fault State
- Block Configuration
- Link Configuration
- Other

Maintenance

- Maintenance Required
- Maintenance Demanded

Information

- Simulation Active
- Local Override
- Power Up
- Out Of Service

XD Error

- Transducer Error

Block Alarm

Block Alarm (tab)

- Unacknowledged
- Alarm State
- Subcode
- Value

Resource Block

Alarms & Errors

Block Error

Block Error (tab)

Failures

- Input Failure
- Output Failure

Resource Block (continued)

Failures (continued)

- Memory Failure
- Lost Static Data
- Lost Non-Volatile Data
- Readback Check

Device Fault State
Block Configuration
Link Configuration
Other

Maintenance

Maintenance Required
Maintenance Demanded

Information

Simulation Active
Local Override
Power Up
Out Of Service

Block Alarm

Block Alarm (tab)

Unacknowledged
Alarm State
Subcode
Value

Write Alarm

Write Alarm (tab)

Unacknowledged
Alarm State
Subcode
Value

Alarm Summary

Alarm Summary (tab)

Current
Discrete Alarm
Block Alarm
Unacknowledged
Discrete Alarm Unacknowledged
Block Alarm Unacknowledged
Unreported
Discrete Alarm Unreported
Block Alarm Unreported

Resource Block (continued)

Alarm Summary (tab) continued

Disabled
Write Alarm Disabled
Block Alarm Disabled

Extended diagnostics

Extended Diagnostics

Extended Diagnostics (tab)

Detailed Error Info

- Device Lifetime Reminder 1
- Device Lifetime Reminder 2
- Calibration Schedule Reminder 1
- Service Schedule Reminder 2
- Internal Error
- External RAM
- Memory RAM
- Memory EEPROM
- Memory EEPROM Flags
- Memory Flash
- Invalid Loader

Process Variables Function Group

Parameter number

Level Transducer Block

process variables

Process Variables

Process Variables (tab)

- Primary Variable
Value

2.7.1 (Page 131)

Trend View (tab)

- Trend Values
Value

Echo Profile

Echo Profile (tab)

Echo Profile Parameters









- Level Measurement
- Distance Measurement
- Confidence
- Near Range

2.4.7.1 (Page 122)

2.4.1 (Page 117)

Parameter Reference

Note



- Most parameters are common to both local and remote operation, and are listed below. For a complete list of AMS parameters, see AMS menu structure (Page 97).
 - To enter Program mode using the device buttons, press **RIGHT** . Press **LEFT**  to return to Measurement mode. Do not use the handheld programmer or local control buttons at the same time as AMS Device Manager, or erratic operation may result.
 - For Quick Access to parameters via the handheld programmer, press **Home** , then enter the menu number, for example **2.3.5**.
 - In Navigation mode, arrow keys     to navigate the menu in the direction of the arrow.
 - Press **RIGHT**  to open Edit Mode, or to save a modification.
 - Parameters are identified by name and organized into function groups, see HMI menu (Page 184).
 - Parameters noted as Read Only in this section of the manual cannot be written via the local user interface, however they may be accessible via other tools. For those accessible via AMS Device Manager, directions are shown in the section Operating via AMS Device Manager (Page 54).
-

8.1 QUICK START (1.)

Wizards provide step-by-step procedures to configure the device, filter out false echoes, and upload and download parameters and firmware to the optional display for easy configuration of multiple LR560s.

8.1.1 QUICK START WIZARD (1.1.)

The Quick Start wizard provides an easy step-by-step procedure to configure the device for a simple application.

From measurement screen, press **RIGHT**  twice to open the Quick Start Wizard menu. Select a wizard, press **RIGHT**  to open the first step, and follow the instructions.

Note

Do not use the Quick Start Wizard to modify individual parameters. Perform customization only after the Quick Start has been completed.

- See Quick Start Wizard via the local display push buttons (Page 40)
- See Quick Start Wizard via the handheld programmer (Page 48)
- See Operating via AMS Device Manager (Page 54)

8.1.2

AFES WIZARD (1.2.)

Note

Incorrect device settings

Before using AFES, configure the device via the Quick Start wizard.

If you have a vessel with known obstructions, we recommend using AFES to prevent false echo detection.

This feature can also be used if SITRANS LR560 displays a false high level, or the reading is fluctuating between the correct level and a false high level.

Make sure the material level is below all known obstructions.

1. Navigate to Level Meter >DIAGNOSTICS (3.) (Page 132)> ECHO PROFILE (3.1.) (Page 132).

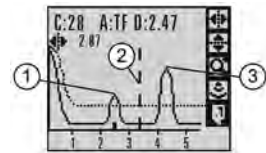

2. Press RIGHT  to request a profile.

3. Determine a range that includes the false echo but not the true echo: in the example, 3.3 m.





① false echo ② AFES range
③ true echo

4. Open the AFES wizard.

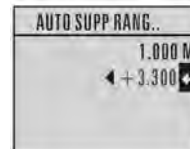
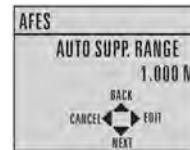
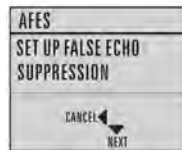
5. Press DOWN  to continue and then RIGHT  to edit Auto False Echo Suppression Range.



6. Enter the new range value and press RIGHT  to transfer it. Press DOWN  to initiate learn. A transition screen appears, followed by the message **Wizard Complete**.

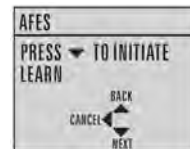

7. Press DOWN  (Finish) to save AFES parameter changes and return to Program menu.

8. Press LEFT  twice to return to Measurement mode.

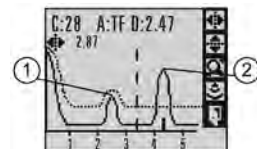



① false echo ② true echo

8.1.3 COPY PARAMETERS TO DISPLAY (1.3.)

Transfers parameter settings from a device to the local display interface.

See Connecting SITRANS LR560 (Page 30) for instructions on removing the local display interface.



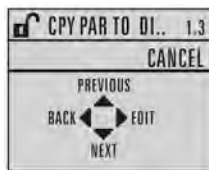

1. Press RIGHT  to edit.
2. Press DOWN  to select Start and RIGHT  to begin the transfer.



PARAM UPLOAD is displayed, then the device returns to Measurement mode.

8.1.4 COPY PARAMETERS FROM DISPLAY (1.4)

Transfers parameter settings from the local display interface to a device.

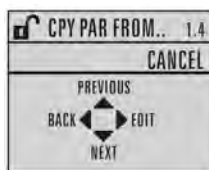

1. Press RIGHT  arrow to edit.
2. Press DOWN  arrow to select Start and RIGHT  arrow to begin the transfer.



PARAM DOWNLOAD is displayed, then the device returns to Measurement mode.

8.1.5 COPY FIRMWARE TO DISPLAY (1.5.)

Transfers firmware from a device to the local display interface.

1. Press RIGHT  to edit.
2. Press DOWN  to select Start and RIGHT  to begin the transfer.

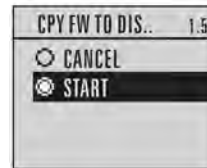
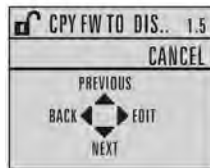

SW UPLOAD is displayed, then the device returns to Measurement mode.



8.1.6 COPY FIRMWARE FROM DISPLAY (1.6.)

Note

Incomplete transfer

Do not interrupt power supply during transfer.

Transfers firmware from the local display interface to a device.

1. Press RIGHT  to edit.
2. Press DOWN  to select Start and RIGHT  to begin the transfer.

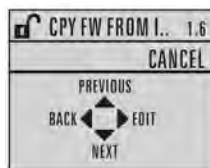

SW DOWNLOAD is displayed, then the device returns to Measurement mode.

8.2 SETUP (2.)

- See Local operation (Page 40) or Operating via AMS Device Manager (Page 54) for instructions.
- Values shown in the following tables can be entered via the handheld programmer or local control buttons.

8.2.1 IDENTIFICATION (2.1.)

8.2.1.1 TAG (2.1.1.)

Text that can be used in any way. A recommended use is as a unique label for a field device in a plant. Limited to 8 ASCII characters. Read only on device, Read/Write using SIMATIC PDM and AMS.

8.2.1.2 DESCRIPTOR (2.1.2.)

Read only. Text that can be used in any way. Limited to 32 ASCII characters. No specific recommended use. To access this parameter via AMS device manager, see **Identification** under Identification (RESOURCE) (Page 80).

8.2.1.3 MESSAGE (2.1.3.)

Read only. Text that can be used in any way. Limited to 32 ASCII characters. No specific recommended use. To access this parameter via AMS device manager, see **Identification** under Identification (RESOURCE) (Page 80).

8.2.1.4 INSTALLATION DATE (2.1.4.)

Read only locally; can be written remotely. The date the device is first commissioned. (Local display format: YY-MM-DD hh:mm:ss)

8.2.2 DEVICE (2.2.)

8.2.2.1 HARDWARE REVISION (2.2.1.)

Read only. Corresponds to the electronics hardware of the device.

8.2.2.2 FIRMWARE REVISION (2.2.2.)

Read only. Corresponds to the firmware that is embedded in the device.

8.2.2.3 LOADER REVISION (2.2.3.)

Read only. Corresponds to the software used to update the device.

8.2.2.4 MANUFACTURE DATE (2.2.4.)

The date of manufacture of the device (dd mm yyyy).

8.2.3 SENSOR (2.3.)

8.2.3.1 UNIT (2.3.1.)

Factory setting:	m
Setting range:	m, cm, mm, ft, in, %
Purpose:	PV (Primary Value) and SV (Secondary Sensor measurement units). Used in setting High/Low Calibration Point, and displayed on LCD and in PDM.
Description:	Changing units to % will update the mA setpoints.

8.2.3.2 LEVEL UNIT (2.3.2.)

The engineering unit used for Level. High Level Point corresponds to High Calibration Point and Low Level Point corresponds to Low Calibration Point.

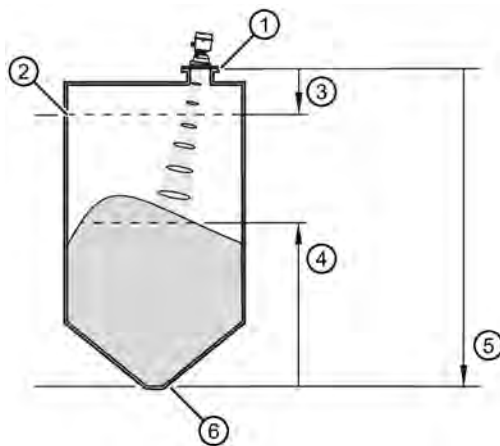

- | | |
|--|------------------------------------|
| ① Sensor reference point ¹⁾ (flange face) | ② High level point (default: 100%) |
| ③ High calibration point | ④ Level |
| ⑤ Low calibration point | ⑥ Low level point (default 0%) |

¹⁾ The point on the sensor from which measurements are referenced (see Dimension drawings (Page 165)) .

Options		m, cm, mm, ft, in,%
	*	%

8.2.3.3 TEMPERATURE UNITS (2.3.3.)

Factory setting:	Degrees C
Setting range:	Degrees C, F, R, or K
Purpose:	Selects the engineering unit to be displayed with the value representing temperature.

8.2.3.4 LOE TIMER (2.3.4.)

Note

When a loss of echo occurs, Loss of Echo (LOE) (Page 180) determines the material level to be reported when the fail-safe timer expires.

Factory setting:	100 s
Setting range:	0.00 to 7200 seconds
Purpose:	Sets the reaction speed of the device to measurement changes.

8.2.3.5 CALIBRATION (2.3.5.)

LOW CALIBRATION POINT (2.3.5.1.)

Factory setting:	40.000 m or 100.000 m
Setting range:	0.000 to 40.000 m or 0.000 to 100.000 m.
Purpose:	Distance from sensor reference point ¹⁾ to Low Calibration Point. Units are defined in UNIT (2.3.1.) (Page 113) and displayed on the LCD and in PDM.
Description:	Any change to Low Calibration Point will cause the mA setpoints to be updated.
Related parameters:	UNIT (2.3.1.) (Page 113) FAR RANGE (2.4.2.) (Page 118)

¹⁾ The point from which level measurement is referenced.

HI CALIBRATION POINT (2.3.5.2.)

Factory setting:	0.000 m
Setting range:	0.000 to 40.000 m or 0.000 to 100.000 m.
Purpose:	Distance from sensor reference point ¹⁾ to High Calibration Point. Units are defined in UNIT (2.3.1.) (Page 113)
Description:	When setting the High Calibration Point value, note that echoes are ignored within NEAR RANGE (2.4.1.) (Page 117). Any change to High Calibration Point will cause the mA setpoints to be updated.
Related parameters:	NEAR RANGE (2.4.1.) (Page 117) UNIT (2.3.1.) (Page 113)

¹⁾ The point from which level measurement is referenced.

SENSOR OFFSET (2.3.5.3.)

Factory setting:	0.00 m
Setting range:	-100 to 100 m
Purpose:	A constant offset that can be added to or subtracted from the sensor value ¹⁾ to compensate for a shifted sensor reference point. For example, when adding a thicker gasket or reducing the standoff/nozzle height. The units are defined in UNIT (2.3.1.) (Page 113).

¹⁾ The value produced by the echo processing which represents the distance from sensor reference point to the target.

LOW LEVEL POINT (2.3.5.4.)

The level when the material is at Low Calibration Point. The unit is defined in LEVEL UNIT (2.3.2.) (Page 113).

Values	Range: -999999 to 999999 Default: 0%
---------------	---

HIGH LEVEL POINT (2.3.5.5.)

The level when the material is at High Calibration Point. The unit is defined in LEVEL UNIT (2.3.2.) (Page 113).

Values	Range: -999999 to 999999 Default: 100%
---------------	---

LEVEL OFFSET (2.3.5.6.)

A constant offset that can be added to Level. The unit is defined in LEVEL UNIT (2.3.2.) (Page 113).

Values	Range: -999999 to 999999 Default: 0%
---------------	---

8.2.3.6 RATE (2.3.6.)

RESPONSE RATE (2.3.6.1.)

Changing Response Rate resets

FILL RATE/MIN (2.3.6.2.) (Page 116)

EMPTY RATE/MIN (2.3.6.3.) (Page 117)

AVERAGE AMOUNT (2.8.3.) (Page 131)

Factory setting:	Medium			
Setting range:	Response rate	FILL RATE/MIN (2.3.6.2.) (Page 116)/EMPTY RATE/MIN (2.3.6.3.) (Page 117)	FILTER TIME CONSTANT (2.5.7.1.) (Page 130)	AVERAGE AMOUNT (2.8.3.) (Page 131)
	Slow	0.1 m/min (0.32 ft/min)	600 s	0.9
	Medium	1.0 m/min (3.28 ft/min)	60 s	0.75
	Fast	10.0 m/min (32.8 ft/min)	0 s	0.75 ^{a)}
Purpose:	Sets the reaction speed of the device to measurement changes.			
Description:	Use a setting just faster than the maximum filling or emptying rate (whichever is faster).			
Related parameters:	FILL RATE/MIN (2.3.6.2.) (Page 116) EMPTY RATE/MIN (2.3.6.3.) (Page 117) AVERAGE AMOUNT (2.8.3.) (Page 131) FILTER TIME CONSTANT (2.5.7.1.) (Page 130)			

^{a)} It may be necessary to reduce this further for FAST applications.

- Use a setting just faster than the maximum filling or emptying rate (whichever is faster).
- For the measurement value update time, see "Update time" in Performance (Page 160).

FILL RATE/MIN (2.3.6.2.)

Factory setting:	Medium	
Setting range:	0 to 999 999 m / min.(when using AMS, max. value is 99 999 m/min.)	
	RESPONSE RATE (2.3.6.1.) (Page 116)	Fill rate/min
	Slow	0.1 m/min (0.32 ft/min)
	Medium	1.0 m/min (3.28 ft/min)
	Fast	10.0 m/min (32.8 ft/min)
Purpose:	Defines the maximum rate at which the reported sensor value ¹⁾ is allowed to increase. Allows you to adjust the SITRANS LR560 response to increases in the actual material level. Fill Rate is automatically updated whenever Response Rate is altered.	
Description:	Enter a value slightly greater than the maximum vessel-filling rate, in units per minute.	
Altered by:	RESPONSE RATE (2.3.6.1.) (Page 116)	
Related parameters:	LEVEL UNIT (2.3.2.) (Page 113)	

¹⁾ Sensor value is the value produced by the echo processing which represents the distance from sensor reference point to the target.

Note

The selected rate will also impact the AVERAGE AMOUNT (2.8.3.) (Page 131) parameter. For example, a SLOW setting will change it to 0.9, and a FAST setting may require it to be reduced to a very low value.

EMPTY RATE/MIN (2.3.6.3.)

Factory setting:	Medium	
Setting range:	Slow	0.1 m/min (0.32 ft/min)
	Medium	1.0 m/min (3.28 ft/min)
	Fast	10.0 m/min (32.8 ft/min)
Purpose:	Defines the maximum rate at which the reported sensor value ¹⁾ is allowed to decrease. Adjusts the SITRANS LR560 response to decreases in the actual material level. Empty Rate is automatically updated whenever RESPONSE RATE (2.3.6.1.) (Page 116) is altered.	
Description:	Enter a value slightly greater than the vessel's maximum emptying rate, in units per minute.	
Altered by:	RESPONSE RATE (2.3.6.1.) (Page 116)	
Related parameters:	LEVEL UNIT (2.3.2.) (Page 113)	

¹⁾ Sensor value is the value produced by the echo processing which represents the distance from sensor reference point to the target. See Sensor Mode (2.2.2.).

Note

The selected rate will also impact the AVERAGE AMOUNT (2.8.3.) (Page 131) parameter. For example, a SLOW setting will change it to 0.9, and a FAST setting may require it to be reduced to a very low value.

8.2.4 SIGNAL PROCESSING (2.4.)**8.2.4.1 NEAR RANGE (2.4.1.)**

Factory setting:	0.278 m (0.91 ft)
Setting range:	0 to 45 m (0 to 131.2 ft) for 40 m device 0 to 105 m (0 to 344.5 ft) for 100 m device
Purpose:	The range in front of the device (measured from the sensor reference point) within which any echoes will be ignored. This is sometimes referred to as blanking or a dead zone.
Related parameters:	UNIT (2.3.1.) (Page 113)

8.2.4.2 FAR RANGE (2.4.2.)

Note

Far Range can extend beyond the bottom of the vessel.

Factory setting:	Value for Low Calibration Pt. + 5 m (16.4 ft)
Setting range:	Min. = Low Cal. Pt. Max. = 40 m device: 45 m (131.2 ft), 100 m device: 105 m (344.5 ft)
Purpose:	Allows the material level to drop below Low Calibration Point without generating a Loss of Echo (LOE) state, see CLEF RANGE (2.4.5.4.) (Page 120).
Description:	Use this feature if the measured surface can drop below the Low Cal. Point in normal operation.
Related parameters:	UNIT (2.3.1.) (Page 113) CLEF RANGE (2.4.5.4.) (Page 120)

8.2.4.3 MINIMUM SENSOR VALUE (2.4.3.)

Read only. Defines the minimum usable value for the measuring range, in units defined in UNIT (2.3.1.) (Page 113). (Default = 0.0 m)

For access via AMS Device Manager see **Range** under Signal Processing (LTB) (Page 69).

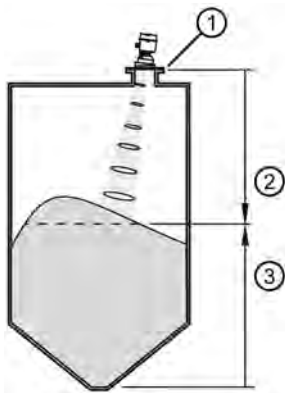

- ① sensor reference point (flange face)
- ② sensor value (distance from sensor reference point to target)
- ③ level

8.2.4.4 MAXIMUM SENSOR VALUE (2.4.4.)

Read only. Defines the maximum usable value for the measuring range, in units defined in UNIT (2.3.1.) (Page 113).

Default depends on device:

40 m device default = 45.0 m

100 m device default = 105 m)

For access via AMS Device Manager see **Range** under Signal Processing (LTB) (Page 69).

8.2.4.5 ECHO SELECT (2.4.5.)

ALGORITHM (2.4.5.1.)

Factory setting:	F: First Echo	
Setting range:	ALF	Area Largest First
	A	Echo Area
	L	Largest Echo
	F	First Echo
	AL	Echo Area Largest
	AF	Echo Area First
	LF	Echo Largest First
	BLF	Best of First and Largest echo
	BL	Best Largest Echo
	BF	Best First Echo
	LAST	Last
	TF	True First Echo
Purpose:	Selects the algorithm to be applied to the echo profile to extract the true echo.	

POSITION DETECT (2.4.5.2.)

Note

Vessel type

Selecting Steel or Concrete vessel type in the Quick Start wizard changes the setting for **Position Detect** to Rising Edge.

Factory setting:	RISING
Setting range:	RISING (yields highest stability on sloped targets)
	CENTER (yields higher accuracy on flat, non-sloped targets)
	HYBRID (CENTER and CLEF)
	CLEF (Constrained Leading Edge Fit)
Purpose:	Defines where on the echo the distance measurement is determined.
Description:	If the vessel bottom is being reported as the level instead of the actual material level (at low conditions), we recommend setting Position to Hybrid and using it in combination with CLEF Range.
Related parameters:	CLEF RANGE (2.4.5.4.) (Page 120)

ECHO THRESHOLD (2.4.5.3.)

Factory setting:	5
Setting range:	0 to 99
Purpose:	Sets the minimum echo confidence that the echo must meet in order to prevent a Loss of Echo condition and the expiration of the Fail-safe (LOE) timer. When CONFIDENCE (2.4.7.1.) (Page 122) exceeds Echo Threshold , the echo is accepted as a valid echo and is evaluated.
Description:	Use this feature when an incorrect material level is reported.
Related parameters:	LOE TIMER (2.3.4.) (Page 114)

CLEF RANGE (2.4.5.4.)

Note

CLEF range

- CLEF Range is referenced from Far Range.
- The value for CLEF Range must include the difference between Far Range and Low Calibration Point, plus any level above the Low Calibration Point to be managed by the CLEF algorithm.

Factory setting:	0.00 m
Setting range:	40 m device: 0 to 45 m 100 m device: 1 to 105 m
Purpose:	The CLEF algorithm is used mainly to allow correct level reporting for low dK materials which may otherwise cause an incorrect reading in an empty or almost empty vessel. It is used from Far Range up to the level defined by CLEF Range (see illustration below). Above that point, the Center algorithm is used.
Related parameters:	POSITION DETECT (2.4.5.2.) (Page 119) FAR RANGE (2.4.2.) (Page 118)

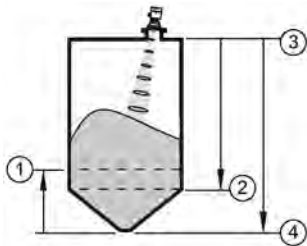

- ① CLEF Range
- ② Low calibration point
- ③ Sensor reference point
- ④ Far range

ECHO MARKER (2.4.5.5.)

Factory setting:	70%
Setting range:	5 to 95%
Purpose:	The point on the selected echo from which the measured value is taken.
Description:	Use this feature if the reported material level fluctuates slightly due to a variable rise in the leading edge of the true echo on the Echo Profile. Enter the value (in percent of echo height) to ensure the Echo Lock window intersects the Echo Profile at the sharpest rising portion of the Echo Profile representing the true echo. This value is preset to 70%.

8.2.4.6 SAMPLING (2.4.6.)

Provides a method of checking the reliability of a new echo before accepting it as the valid reading, based on numbers of samples above or below the currently selected echo.

8.2.4.7 ECHO LOCK (2.4.6.1.)

Factory setting:	Material Agitator
Setting range:	Lock Off
	Maximum Verification (not recommended for radar)
	Material Agitator
	Total Lock (not recommended for radar)
Purpose:	Selects the measurement verification process.
Related parameters:	FILL RATE/MIN (2.3.6.2.) (Page 116) EMPTY RATE/MIN (2.3.6.3.) (Page 117) UP SAMPLING (2.4.6.2.) (Page 121) DOWN SAMPLING (2.4.6.3.) (Page 121)

8.2.4.8 UP SAMPLING (2.4.6.2.)

Factory setting:	5
Setting range:	1 to 50
Purpose:	Specifies the number of consecutive echoes that must appear above the echo currently selected, before the measurement is accepted as valid.

8.2.4.9 DOWN SAMPLING (2.4.6.3.)

Factory setting:	2
Setting range:	1 to 50
Purpose:	Specifies the number of consecutive echoes that must appear below the echo currently selected, before the measurement is accepted as valid.

8.2.4.10 ECHO LOCK WINDOW (2.4.6.4.)

Factory setting:	0 m
Setting range:	40 m device: 0 to 45 m, 100 m device: 0 to 105 m
Purpose:	A "distance window" centered on the echo is used to derive the reading. When a new measurement is in the window, the window is re-centered and the reading is calculated.
Description:	When the value is 0, the window is automatically calculated after each measurement. <ul style="list-style-type: none"> • For slower Measurement Response values, the window grows at a slower rate. • For faster Measurement Response values, the window grows at a faster rate.

Note

Values in Echo Lock window

The Echo Lock window is stored as a standard sample, but displayed in sensor units. Any value entered for the Echo Lock window will be rounded to the nearest sample.

8.2.4.11 ECHO QUALITY (2.4.7.)

CONFIDENCE (2.4.7.1.)

Setting range (view only):	0 to 99	
	----	Shot not used
Purpose:	Indicates echo reliability: higher values represent better echo quality. The display shows the echo confidence of the last measurement. ECHO THRESHOLD (2.4.5.3.) (Page 120) defines the minimum criterion for echo confidence.	

ECHO STRENGTH (2.4.7.2.)

Setting range (view only):	-20 to 99
Purpose:	Displays the absolute strength (in dB above 1 μ V rms) of the echo selected as the measurement echo.

8.2.4.12 TVT SETUP (2.4.8.)

Note

We recommend using AFES Wizard, see AFES WIZARD (1.2.) (Page 109).

8.2.4.13 AUTO ECHO SUPPRESSION (2.4.8.1.)

Used together with AUTO SUPPRESSION RANGE (2.4.8.2.) (Page 125) to screen out false echoes in a vessel with known obstructions. A 'learned TVT' (time varying threshold) replaces the default TVT over a specified range.

1. Make sure material level is below all known obstructions when Auto False Echo Suppression is used to learn the echo profile. (An empty or almost empty vessel is recommended.)
2. Determine **Auto False Echo Suppression Range**. Measure the actual distance from the sensor reference point to the material surface using a rope or tape measure.
3. Subtract 0.5 m (20") from this distance, and enter the resulting value in AUTO SUPPRESSION RANGE (2.4.8.2.) (Page 125).

Before Auto False Echo Suppression

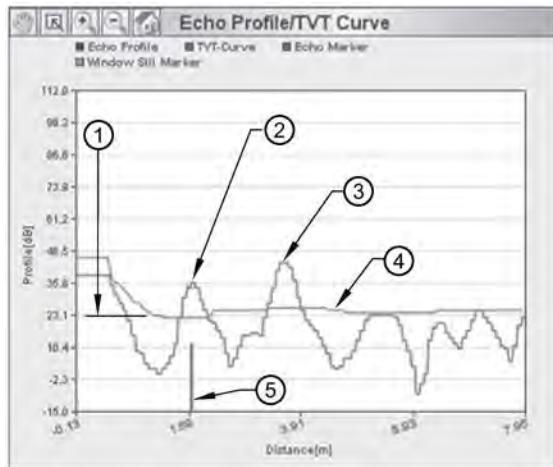

- ① TVT Hover Level
- ② false echo
- ③ material level
- ④ default TVT
- ⑤ echo marker

After Auto False Echo Suppression

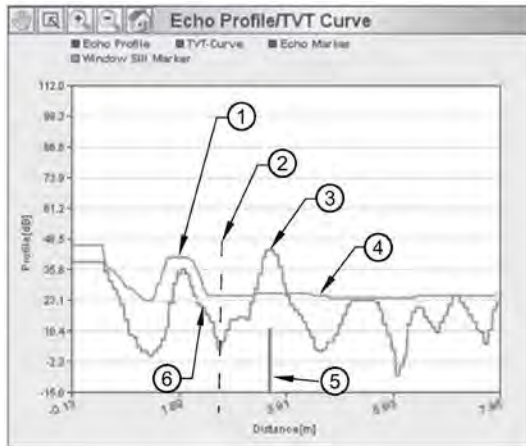

- ① learned TVT
- ② Auto False Echo Suppression Range
- ③ material level
- ④ default TVT
- ⑤ echo marker
- ⑥ false echo

To use Auto False Echo Suppression via AMS Device Manager:

Note value calculated in step b) and see TVT (Page 70).

To set Auto False Echo Suppression via local operation:

See AFES WIZARD (1.2.) (Page 109).

8.2.4.14 AUTO SUPPRESSION RANGE (2.4.8.2.)

Factory setting:	1.00 m
Setting range:	0.00 to 45.00 m (or 105.00 m depending on model)
Purpose:	Defines the endpoint of the Learned TVT distance. Units are defined in UNIT (2.3.1.) (Page 113).
Description:	Used in combination with AUTO ECHO SUPPRESSION (2.4.8.1.) (Page 123).

8.2.4.15 HOVER LEVEL (2.4.8.3.)

Note

Changes take effect only at the next measurement.

Factory setting:	40%
Setting range:	0 to 100%
Purpose:	Defines how high the TVT (Time Varying Threshold) is placed above the noise floor of the echo profile, as a percentage of the difference between the peak of the largest echo in the profile and the noise floor.
Description:	When the device is located in the center of the vessel, the TVT hover level may be lowered to increase the confidence level of the largest echo.

8.2.4.16 SHAPER MODE (2.4.8.4.)

Factory setting:	OFF
Setting range:	ON, OFF
Purpose:	Enables/disables the TVT shaper.

8.2.4.17 TVT SHAPER (2.4.9.)

Note

- SHAPER MODE (2.4.8.4.) (Page 125) must be turned ON in order for TVT shaper breakpoints to be transferred
 - We recommend using AMS Device Manager to access this feature.
 - Put LTB Block into OOS Mode before changing settings, then back into AUTO mode to display TVT.
-

Adjusts the TVT (Time Varying Threshold) at a specified range (breakpoint on the TVT). This allows you to reshape the TVT to avoid unwanted echoes. There are 120 breakpoints arranged in 14 groups.

Values	Range:	-50 to +50 dB
	Default:	0

To access TVT shaper via AMS Device Manager see TVT Shaper 1 (Page 125).

To use TVT shaper via local operation:

1. Go to SHAPER MODE (2.4.8.4.) (Page 125) and select option ON.
2. In TVT shaper, go to **Shaper 1-9 (2.4.9.1.)**.
3. Open Shaper 1 and enter the TVT Offset value (between –50 and +50 dB).
4. Go to the next Shaper point and repeat step (c) till all desired breakpoint values have been entered.

2.4.9.1. Shaper 1-9

2.4.9.2. Shaper 10-18

2.4.9.3. Shaper 19-27

2.4.9.4. Shaper 28-36

2.4.9.5. Shaper 37-45

2.4.9.6. Shaper 46-54

2.4.9.7. Shaper 55-63

2.4.9.8. Shaper 64-72

2.4.9.9. Shaper 73-81

2.4.9.10. Shaper 82-90

2.4.9.11. Shaper 91-99

2.4.9.12. Shaper 100-108

2.4.9.13. Shaper 109-117

2.4.9.14. Shaper 118-120

8.2.5 AIFB1 (2.5.)

8.2.5.1 STATIC REVISION NO. (2.5.1.)

Purpose:	The revision level of the static data associated with Analog Input Function Block 1.
Description:	The Static Revision No. is updated whenever a configuration parameter is changed.

8.2.5.2 MODE (2.5.2.)

Note

Ensure that Mode is returned to **AUTO** when simulation or maintenance are completed..

Used to request an operating mode from the Analog Input Function Block. It allows you to put SITRANS LR560 into Manual mode (used in conjunction with Simulation) or Out-of-Service mode for maintenance purposes.

Setting	Description	Output value
AUTO	automatic	the automatically-recorded measured value
MAN	manual	a manually-set fixed simulation value
O/S	function block disabled	the preset safety value

Manual Mode can be used when simulating output.

8.2.5.3 CHANNEL (2.5.3.)

Factory setting:	Distance	
Setting range:	Options	Reference point
	Level/Volume (PV - Primary Value). Note: Volume is a standard option, but not supported by LR560.	Low Calibration Point
	Level (SV1 - Secondary Value 1)	Low Calibration Point
	Distance (SV2 - Secondary Value 2)	Sensor Reference Point
Purpose:	Used to select the Transducer Block output.	

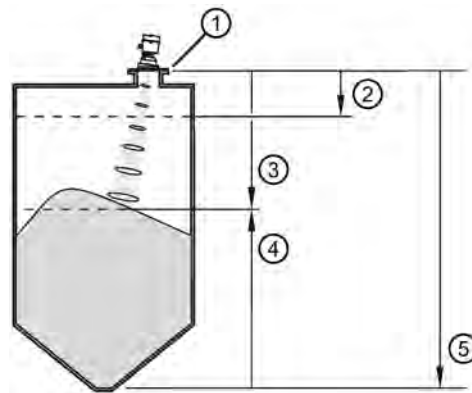

- ① Sensor reference point
- ② High calibration point (process full level)
- ③ Distance (SV2)
- ④ Level (SV1)
- ⑤ Low calibration point (process empty level)

8.2.5.4 INPUT SCALING (2.5.4)

Input scaling should match the XD_scale from the Level Transducer Block. See the manual Foundation Fieldbus for Level instruments (7ML19985MP01) for more detail.

LOWER VALUE (2.5.4.1.)

Factory setting:	0%
Setting range:	Range: -999999 to 999999
Purpose:	Defines the operational lower range value of the input value (Process Value Scale) in PV (volume/level) Units. Process Value Scale normalizes the input value to a customer-defined range.

UPPER VALUE (2.5.4.2.)

Factory setting:	100%
Setting range:	Range: -999999 to 999999
Purpose:	Defines the operational upper range value of the input value (Process Value Scale) in PV (volume/level) Units. Process Value Scale normalizes the input value to a customer-defined range.

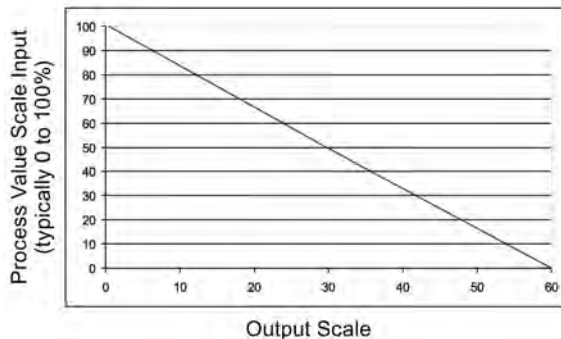

UNIT (2.5.4.3.)

Engineering unit to be displayed with the output value.

Options		m, cm, mm, ft, in, %, Not Used, Unknown, Special
	*	%

DECIMAL POINT (2.5.4.4.)

Read only. The number of digits to display after the decimal point (fixed to one).

8.2.5.5 OUTPUT SCALING (2.5.5.)

Scales the Process Variable. The function block parameter OUT SCALE contains the values of the lower limit and upper limit effective range in AIFB1 units.

LOWER VALUE (2.5.5.1.)

Factory setting:	0%
Setting range:	Range: -999999 to 999999
Purpose:	Defines the operational lower range value of the output value in AIFB1 units.

UPPER VALUE (2.5.5.2.)

Factory setting:	100%
Setting range:	Range: -999999 to 999999
Purpose:	Defines the operational upper range value of the output value in AIFB1 units.

UNIT (2.5.5.3.)

Engineering unit to be displayed with the output value.

Options		m, cm, mm, ft, in, %, Not Used, Unknown, Special
	*	%

DECIMAL POINT (2.5.5.4.)

Read only. The number of digits to display after the decimal point (fixed to one).

8.2.5.6 HI LIMIT ALARM (2.5.6.1.)

Factory setting:	999
Setting range:	Range: -999999 to 999999
Purpose:	The setting for the upper alarm limit in AIFB1 units.

8.2.5.7 HI LIMIT WARNING (2.5.6.2.)

Factory setting:	999
Setting range:	Range: -999999 to 999999
Purpose:	The setting for the upper warning limit in AIFB1 units.

8.2.5.8 LO LIMIT WARNING (2.5.6.3.)

Factory setting:	-999
Setting range:	Range: -999999 to 999999
Purpose:	The setting for the lower warning limit in AIFB1 units.

8.2.5.9 LO LIMIT ALARM (2.5.6.4.)

Factory setting:	-999
Setting range:	Range: -999999 to 999999
Purpose:	The setting for the lower alarm limit in AIFB1 units.

8.2.5.10 LIMIT HYSTERESIS (2.5.6.5.)

Factory setting:	0.20 for 40 m version 0.50 for 100 m version
Setting range:	Range: 0 to 999999.00
Purpose:	Hysteresis is used to adjust the sensitivity of the trigger for alarm messages. It is used to compensate when a process variable fluctuates around the same value as a limit. A high level alarm occurs when a value exceeds an upper limit. The alarm's status remains true until the value drops below the limit minus the alarm hysteresis. The directions are reversed for low limit detection.
Description:	Enter a value for the hysteresis here, to be used for all warnings and alarms. The units are the same as the Output scale, i.e. AIFB1 units.

8.2.5.11 FILTER TIME CONSTANT (2.5.7.1.)

The time constant for the damping filter. The damping filter smooths out the response to a sudden change in level. This is a first order filter and the engineering unit is always in seconds, see Damping (Page 180) for more detail.

Values	Range: Any non-negative number can be entered Unit: s
	Default: 0 ^{a)}

^{a)} To meet accuracy specification, Filter Time Constant (PV_FTIME) must be changed from default of 0.0 s to a minimum of 10.0 seconds, see Performance (Page 160).

8.2.6 AIFB 2 (2.6.)

See AIFB1 (2.5.) (Page 126). The parameters for AIFB 2 are identical to AIFB 1.

8.2.7 MEASURED VALUES (2.7.)

Read only. Allows you to view measured values for diagnostic purposes.

8.2.8 MAIN OUTPUT (2.7.1.)

The value for Level.

In AMS Device Manager, see Process Variables (Level Transducer Block - LTB) (Page 93).

8.2.9 OUTPUT NO LINEARIZATION (2.7.2.)

The value for Level.

8.2.10 OUTPUT NO OFFSETS (2.7.3.)

The value for Distance.

8.2.11 NARROW ECHO FILTER (2.8.1.)

Factory setting:	0 = OFF
Setting range:	0 to 255, greater = wider
Purpose:	Filters out echoes of a specific width.
Description:	To remove a false echo from the Echo Profile, take its width in mm and multiply it by 0.006. Enter the result. Example: to filter out a spike with 500 mm width, enter 6 or 7 (the closest integer product of 500 x 0.006). When a value is keyed in, the nearest acceptable value is entered.

8.2.12 REFORM ECHO (2.8.2.)

Factory setting:	0 = OFF
Setting range:	0 to 255 samples, greater = wider (recommended: 10 samples)
Purpose:	Smooths jagged peaks in the echo profile. Reforms fragmented echoes into one echo.

8.2.13 AVERAGE AMOUNT (2.8.3.)

Factory setting:	0.75
Setting range:	0.0 to 0.99
Purpose:	The fraction of the old shot data that is kept for averaging purposes. A higher value will give a smoother profile at the expense of a slower echo profile response.

8.3 DIAGNOSTICS (3.)

8.3.1 ECHO PROFILE (3.1.)

Note

- LTB Block must be put back to AUTO mode to display Echo Profile.
 - Selected icon is highlighted.
-

Allows you to request the current echo profile either via the handheld programmer, the local buttons, or via AMS Device Manager. For more detail see Echo processing (Page 173).

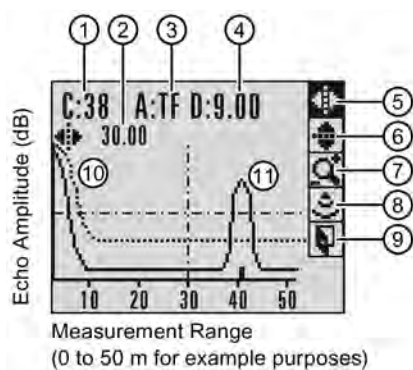

- | | |
|---|--|
| ① confidence value | ② distance from Low Calibration Point to vertical cross-hair |
| ③ algorithm selection (trueFirst echo) | ④ distance from flange face to target |
| ⑤ pan left/right - selected/highlighted | ⑥ pan up/down |
| ⑦ zoom in/out | ⑧ measure |
| ⑨ exit | |



exit icon, deselected



exit icon selected /highlighted

- To request a profile via AMS Device Manager, see Echo profile (Page 73).
- To request a profile via the handheld programmer or local control buttons:

In PROGRAM mode, navigate to **Echo Profile (3.1)**, see Requesting an Echo Profile (Page 52) for more details.

8.3.2 FAULT RESET (3.2)

Clears faults (see chart below).

Clearing a fault in one parameter of a 'maintenance pair', automatically clears a fault in the second parameter of the pair. For example, entering S3 or S4 will clear a fault on Device (Maintenance Required), and on Device (Maintenance Demanded). This applies when clearing faults via the handheld programmer, or the 375 Field Communicator.

Fault Code	Description
S3	Device Lifetime Reminder 1 (Maintenance Required)
S4	Device Lifetime Reminder 2 (Maintenance Demanded)
S6	Sensor Lifetime Reminder 1 (Maintenance Required)
S7	Sensor Lifetime Reminder 2 (Maintenance Demanded)
S8	Service Schedule Reminder 1 (Maintenance Required)
S9	Service Schedule Reminder 2 (Maintenance Demanded)
S12	Internal Temperature High
S17	Calibration Schedule Reminder 1 (Maintenance Required)
S18	Calibration Schedule Reminder 2 (Maintenance Demanded)

To clear a fault using the handheld programmer:

- Enter the fault code number then press RIGHT arrow.

8.3.3 TREND (3.3.)

Displays the trend of the Process Variables: sensor value, and outputs from AIFB 1/AIFB 2. Samples are saved every minute up to 3200 samples. Once the maximum number is reached, saved data is overwritten from the beginning.

Under Process Variables (Level Transducer Block - LTB) (Page 93), see **Trend View**.

8.3.4 ELECTRONICS TEMPERATURE (3.4.)

To access the following parameters via AMS Device Manager see **Electronics Temperature** under Maintenance & Diagnostics (LTB) (Page 73).

8.3.5 MINIMUM VALUE (3.4.1.)

The minimum recorded internal electronics temperature, reported in units defined in UNIT (2.3.1.) (Page 113).

8.3.6 MAXIMUM VALUE (3.4.2.)

The maximum recorded internal electronics temperature, reported in units defined in UNIT (2.3.1.) (Page 113).

8.3.7 PEAK VALUES (3.5.)

8.3.7.1 MINIMUM MEASURED VALUE (3.5.1.)

The minimum recorded Sensor value, reported in units defined in UNIT (2.3.1.) (Page 113).

8.3.7.2 MAXIMUM MEASURED VALUE (3.5.2.)

The maximum recorded Sensor value, reported in units defined in UNIT (2.3.1.) (Page 113).

8.4 SERVICE (4.)

8.4.1 MASTER RESET (4.1.)

Note

- The following parameters are not reset by any reset type: Write Protection, Auto False Echo Suppression Range, Learned TVT.
 - While an FF Object Dictionary Reset is in progress, the Master Reset Parameter View showing PREVIOUS/NEXT/BACK/EDIT options will be displayed. Do not perform an action using the local display interface until the reset is complete^{b)}. This could cause a temporary loss of communications.
-

Reset Type	Result
Factory Defaults ^{a)}	Default. Resets all user parameters to the manufacturer's default settings. Following this type of reset, complete reprogramming is required.
Informational	Resets parameters such as Block Descriptor, Strategy, Device Install Date, Device Message.
Functional ^{a)}	Resets parameters that control device behavior and functionality (such as Low Calibration Point).
Warm Start	Has the same effect as recycling power to the device.
FF Object Dictionary ^{b)}	Resets all user parameters except for calibration to Factory Defaults. This option also clears any function block parameters and device schedule ^{c)} set by the user.

^{a)} The only difference between Factory Defaults and Functional reset is that Factory Defaults resets maintenance parameters, such as device and sensor wear, calibration and maintenance timers. Functional reset does not reset these parameters.

^{b)} FF Object Dictionary reset completes with an automatic power cycle.

^{c)} See the manual Foundation Fieldbus for Level instruments (7ML19985MP01), Data Transmission, for more details.

To perform a reset via AMS Device Manager:

- see **Master Reset** under Operation (RESOURCE) (Page 81).

To perform a reset via local operation:

1. Press **RIGHT Arrow** to open Edit Mode then scroll down to the desired reset type and press **RIGHT Arrow** to select it.
2. Press **LEFT Arrow** to exit.

After a master reset is performed, the device will stop measuring, the Resource and Level Transducer Blocks will go to **Out of Service**, and the LCD will display the **Quick Start Wizard** until the device is configured.

8.4.2 REMAINING DEVICE LIFETIME (4.2.)

Note

- Default settings in the parameter tables are indicated with an asterisk (*) unless explicitly stated.
 - Four sets of parameters allow you to monitor the Device/Sensor Lifetimes and set up Maintenance/Service schedules, based on operating hours instead of a calendar-based schedule. See also REMAINING SENSOR LIFETIME (4.3.) (Page 137), SERVICE SCHEDULE (4.4.) (Page 139), and CALIBRATION SCHEDULE (4.5.) (Page 141).
 - Performing a reset to **Factory Defaults** will reset all the Maintenance Schedule parameters to their factory defaults.
 - The device operates in years. To view Remaining Device Lifetime parameters in hours (via AMS Device Manager only) see REMAINING DEVICE LIFETIME (4.2.) (Page 135).
-

The device tracks itself based on operating hours and monitors its predicted lifetime. You can modify the expected device lifetime, set up schedules for maintenance alerts, and acknowledge them.

The maintenance warnings and alarms are communicated to the end user through status information. This information can be integrated into any Asset Management system.

To access these parameters via AMS Device Manager, see **Remaining Device Lifetime** under Device Diagnostics (Resource Block-RESOURCE) (Page 90).

8.4.2.1 LIFETIME EXPECTED (4.2.1.)

Allows you to override the factory default.

Values

Units: years

Range: 0 to 20 years

Default: 10.00 years

8.4.2.2 TIME IN OPERATION (4.2.2.)

Read only. The amount of time the device has been operating.

8.4.2.3 REMAINING LIFETIME (4.2.3.)

Read only. LIFETIME EXPECTED (4.2.1.) (Page 135) less TIME IN OPERATION (4.2.2.) (Page 136).

8.4.2.4 REMINDER ACTIVATION (4.2.4.)

Allows you to enable a maintenance reminder.

Options REMinder 1 (Maintenance REQuired)
 REMinder 2 (Maintenance DEManded)
 REMinders 1 AND 2 (Maintenance Required and Maintenance Demand-
 ed)
 * OFF

1. First set the reminder values in REMINDER 1 (REQUIRED) (4.2.5.) (Page 136)/REMINDER 2 (DEMANDED) (4.2.6.) (Page 136).
2. Select the desired **Reminder Activation** option.

8.4.2.5 REMINDER 1 (REQUIRED) (4.2.5.)

Factory setting:	0.164 years
Setting range:	0 to 20 years
Purpose:	If REMAINING LIFETIME (4.2.3.) (Page 136) is equal to or less than this value, the device generates a Maintenance Required reminder.
Description:	1) Modify values as required. 2) Set REMINDER ACTIVATION (4.2.4.) (Page 136).

8.4.2.6 REMINDER 2 (DEMANDED) (4.2.6.)

Factory setting:	0.019 years
Setting range:	0 to 20 years
Purpose:	If REMAINING LIFETIME (4.2.3.) (Page 136) is equal to or less than this value, the device generates a Maintenance Demanded reminder.
Description:	1) Modify values as required. 2) Set REMINDER ACTIVATION (4.2.4.) (Page 136).

8.4.2.7 MAINTENANCE STATUS (4.2.7.)

Indicates which level of maintenance reminder is active.

To display the level of maintenance reminder that is active in AMS Device Manager see **Extended Diagnostics (RESOURCE)** under Device Diagnostics (Resource Block-RESOURCE) (Page 90).



8.4.2.8 ACKNOWLEDGE STATUS (4.2.8.)

Indicates which level of maintenance reminder has been acknowledged.

8.4.2.9 ACKNOWLEDGE (4.2.9.)

Acknowledges the current maintenance reminder.

To acknowledge an alert via the handheld programmer:

1. Press **RIGHT**  twice to open parameter view and activate **Edit Mode**.
2. Press **RIGHT**  to acknowledge the alert.

8.4.3 REMAINING SENSOR LIFETIME (4.3.)

Note

- Default settings in the parameter tables are indicated with an asterisk (*) unless explicitly stated.
 - Four sets of parameters allow you to monitor the Device/Sensor Lifetimes and set up Maintenance/Service schedules, based on operating hours instead of a calendar-based schedule. See also REMAINING DEVICE LIFETIME (4.2.) (Page 135), SERVICE SCHEDULE (4.4.) (Page 139), and CALIBRATION SCHEDULE (4.5.) (Page 141).
 - Performing a reset to **Factory Defaults** will reset all the Maintenance Schedule parameters to their factory defaults.
 - The device operates in years. To view Remaining Sensor Lifetime parameters in hours (via AMS Device Manager only) see REMAINING SENSOR LIFETIME (4.3.) (Page 137).
-

The device monitors the predicted lifetime of the sensor (the components exposed to the vessel environment). You can modify the expected sensor lifetime, set up schedules for maintenance alerts, and acknowledge them.

To access these parameters via AMS Device Manager see **Remaining Sensor Lifetime** under Maintenance & Diagnostics (LTB) (Page 73).

8.4.3.1 LIFETIME EXPECTED (4.3.1.)

Allows you to override the factory default.

Values

Units: years

Range: 0 to 20 years

Default: 10.00 years

8.4.3.2 TIME IN OPERATION (4.3.2.)

Read only. The amount of time the sensor has been operating.

8.4.3.3 REMAINING LIFETIME (4.3.3.)

Read only. LIFETIME EXPECTED (4.3.1.) (Page 137) less TIME IN OPERATION (4.3.2.) (Page 137).

8.4.3.4 REMINDER ACTIVATION (4.3.4.)

Allows you to enable a maintenance reminder.

Options REMinder 1 (Maintenance REQuired)
 REMinder 2 (Maintenance DEManded)
 REMinders 1 AND 2 (Maintenance Required and Maintenance De-
 manded)
 * OFF

1. First set the limit values in REMINDER 1 (REQUIRED) (4.3.5.) (Page 138)/REMINDER 2 (DEMANDED) (4.3.6.) (Page 138).
2. Select the desired **Reminder Activation** option.

8.4.3.5 REMINDER 1 (REQUIRED) (4.3.5.)

Factory setting:	0.164 years
Setting range:	0 to 20 years
Purpose:	If REMAINING LIFETIME (4.3.3.) (Page 138) is equal to or less than this value, the device generates a Maintenance Required reminder.
Description:	1. Modify values as required. 2. Set REMINDER ACTIVATION (4.3.4.) (Page 138) to the desired option.

8.4.3.6 REMINDER 2 (DEMANDED) (4.3.6.)

Factory setting:	0.019 years
Setting range:	0 to 20 years
Purpose:	If REMAINING LIFETIME (4.3.3.) (Page 138) is equal to or less than this value, the device generates a Maintenance Demanded reminder.
Description:	1. Modify values as required. 2. Set REMINDER ACTIVATION (4.3.4.) (Page 138) to the desired option.

8.4.3.7 MAINTENANCE STATUS (4.3.7.)

Indicates which level of maintenance reminder is active.

To display the level of maintenance reminder that is active in AMS Device Manager see **Extended Diagnostics (RESOURCE)** under Device diagnostics (Level Transducer Block-LBT) (Page 87).



8.4.3.8 ACKNOWLEDGE STATUS (4.3.8.)

Indicates which level of maintenance reminder has been acknowledged.

8.4.3.9 ACKNOWLEDGE (4.3.9.)

Acknowledges the current maintenance reminder.

To acknowledge an alert via the handheld programmer:

1. Press **RIGHT**  twice to open parameter view and activate **Edit Mode**.
2. Press **RIGHT**  to acknowledge the alert.

8.4.4 SERVICE SCHEDULE (4.4.)

The device tracks service intervals based on operating hours and monitors the predicted lifetime to the next service. You can modify the Total Service Interval, set schedules for Maintenance Alerts, and acknowledge them.

The maintenance warnings and alarms are communicated to the end user through status information. This information can be integrated into any Asset Management system.

To access these parameters via AMS Device Manager see **Service schedule** under Maintenance & Diagnostics (LTB) (Page 73).

Note

- Four sets of parameters allow you to monitor the Device/Sensor Lifetimes and set up Maintenance/Service schedules, based on operating hours instead of a calendar-based schedule. See also REMAINING DEVICE LIFETIME (4.2.) (Page 135), REMAINING SENSOR LIFETIME (4.3.) (Page 137), and CALIBRATION SCHEDULE (4.5.) (Page 141).
 - Performing a reset to Factory Defaults will reset all the Maintenance Schedule parameters to their factory defaults.
 - The device operates in years. To view Service Interval parameters in hours (via AMS Device Manager only) see **Service schedule** under Maintenance & Diagnostics (LTB) (Page 73).
-

8.4.4.1 SERVICE INTERVAL (4.4.1.)

User-configurable recommended time between product inspections.

Values Units: years
Range: 0 to 20 years
Default: 1.0 year

8.4.4.2 TIME SINCE LAST SERVICE (4.4.2.)

Time elapsed since last service. Can be reset to zero after performing a service.

To reset to zero:

- Via the handheld programmer, manually reset **Time Last Serviced (4.4.2.)** to zero.

8.4.4.3 TIME UNTIL NEXT SERVICE (4.4.3.)

Read only. SERVICE INTERVAL (4.4.1.) (Page 139) less TIME SINCE LAST SERVICE (4.4.2.) (Page 139).

8.4.4.4 REMINDER ACTIVATION (4.4.4.)

Allows you to enable a maintenance reminder.

Values

- * TIMER OFF
- ON NO LIMITS
- ON REMinder 1 (Maintenance Required) checked
- ON REMinders 1 - 2 checked
- ON - REMinder 2 (Maintenance Demanded) checked

1. First set the limit values in REMINDER 1 (REQUIRED) (4.4.5.) (Page 140)/REMINDER 2 (DEMANDED) (4.4.6.) (Page 140).
2. Select the desired **Reminder Activation** option.

8.4.4.5 REMINDER 1 (REQUIRED) (4.4.5.)

Factory setting:	0.164 years
Setting range:	0 to 20 years
Purpose:	If TIME UNTIL NEXT SERVICE (4.4.3.) (Page 140) is equal to or less than this value, the device generates a Maintenance Required reminder.
Description:	<ol style="list-style-type: none">1. Modify values as required.2. Set REMINDER 2 (DEMANDED) (4.4.6.) (Page 140) to the desired option.

8.4.4.6 REMINDER 2 (DEMANDED) (4.4.6.)

Factory setting:	0.019 years
Setting range:	0 to 20 years
Purpose:	If TIME UNTIL NEXT SERVICE (4.4.3.) (Page 140) is equal to or less than this value, the device generates a Maintenance Demanded reminder.
Description:	<ol style="list-style-type: none">1. Modify values as required.2. Set REMINDER ACTIVATION (4.4.4.) (Page 140) to the desired option.

8.4.4.7 MAINTENANCE STATUS (4.4.7.)

Indicates which level of maintenance reminder is active.

To display the level of maintenance reminder that is active in AMS Device Manager see **Extended Diagnostics (RESOURCE)** under Device diagnostics (Level Transducer Block-LBT) (Page 87).



8.4.4.8 ACKNOWLEDGE STATUS (4.4.8.)

Indicates which level of maintenance reminder has been acknowledged.

8.4.4.9 ACKNOWLEDGE (4.4.9.)

Acknowledges the current maintenance reminder.

To acknowledge an alert via the handheld programmer:

1. Press **RIGHT**  twice to open parameter view and activate **Edit Mode**.
2. Press **RIGHT**  to acknowledge the alert.

8.4.5 CALIBRATION SCHEDULE (4.5.)

Note

- Default settings in the parameter tables are indicated with an asterisk (*) unless explicitly stated.
 - Four sets of parameters allow you to monitor the Device/Sensor Lifetimes and set up Maintenance/Service schedules, based on operating hours instead of a calendar-based schedule. See also REMAINING DEVICE LIFETIME (4.2.) (Page 135), REMAINING SENSOR LIFETIME (4.3.) (Page 137), and SERVICE SCHEDULE (4.4.) (Page 139).
 - Performing a reset to **Factory Defaults** will reset all the Maintenance Schedule parameters to their factory defaults.
 - The device operates in years. To view Calibration Interval parameters in hours (via AMS Device Manager only) see **Calibration schedule** under Maintenance & Diagnostics (RESOURCE) (Page 84).
-

The device tracks calibration intervals based on operating hours and monitors the predicted lifetime to the next calibration. You can modify the Total Calibration Interval, set schedules for Maintenance Alerts, and acknowledge them.

To access these parameters via AMS Device Manager see **Calibration schedule** under Maintenance & Diagnostics (RESOURCE) (Page 84).

8.4.5.1 CALIBRATION INTERVAL (4.5.1.)

User-configurable recommended time between product calibrations.

Values Units: years
 Range: 0 to 20 years
 Default: 1.0 year

8.4.5.2 TIME SINCE LAST CALIBRATION (4.5.2.)

Time elapsed since last calibration. Can be reset to zero after performing a calibration.

To reset to zero:

- Via the handheld programmer, manually reset **Time Last Calibrated (4.5.2.)** to zero.

8.4.5.3 TIME UNTIL NEXT CALIBRATION (4.5.3.)

Read only. CALIBRATION INTERVAL (4.5.1.) (Page 141) less TIME SINCE LAST CALIBRATION (4.5.2.) (Page 141).

8.4.5.4 REMINDER ACTIVATION (4.5.4.)

Allows you to enable a maintenance reminder.

Values * TIMER OFF
ON NO LIMITS
ON REMinder 1 (Maintenance Required) checked
ON REMinders 1 - 2 checked
ON - REMinder 2 (Maintenance Demanded) checked

1. First set the limit values in REMINDER 1 (REQUIRED) (4.5.5.) (Page 142)/REMINDER 2 (DEMANDED) (4.5.6.) (Page 142).
2. Select the desired Reminder Activation option.

8.4.5.5 REMINDER 1 (REQUIRED) (4.5.5.)

Factory setting:	0.164 years
Setting range:	0 to 20 years
Purpose:	If TIME UNTIL NEXT CALIBRATION (4.5.3.) (Page 142) is equal to or less than this value, the device generates a Maintenance Required reminder.
Description:	<ol style="list-style-type: none">1. Modify values as required.2. Set REMINDER ACTIVATION (4.5.4.) (Page 142) to the desired option.

8.4.5.6 REMINDER 2 (DEMANDED) (4.5.6.)

Factory setting:	0.019 years
Setting range:	0 to 20 years
Purpose:	If TIME UNTIL NEXT CALIBRATION (4.5.3.) (Page 142) is equal to or less than this value, the device generates a Maintenance Demanded reminder.
Description:	<ol style="list-style-type: none">1. Modify values as required.2. Set Reminder Activation (4.8.5.) (Page 142) to the desired option.

8.4.5.7 MAINTENANCE STATUS (4.5.7.)

Indicates which level of maintenance reminder is active.

To display the level of maintenance reminder that is active in AMS Device Manager see **Extended Diagnostics (RESOURCE)** under Device diagnostics (Level Transducer Block-LBT) (Page 87).



8.4.5.8 ACKNOWLEDGE STATUS (4.5.8.)

Indicates which level of maintenance reminder has been acknowledged.

8.4.5.9 ACKNOWLEDGE (4.5.9.)

Acknowledges the current maintenance reminder.

To acknowledge an alert via the handheld programmer:

1. Press **RIGHT**  twice to open parameter view and activate **Edit Mode**.
2. Press **RIGHT**  to acknowledge the alert.

8.4.6 POWERED HOURS (4.6.)

Displays the number of hours the unit has been powered up since manufacture.

To view via AMS Device Manager see **Wear** under Maintenance & Diagnostics (RESOURCE) (Page 84).

8.4.7 POWERON RESETS (4.7.)

The number of power cycles that have occurred since manufacture.

To view via AMS Device Manager see **Wear** under Maintenance & Diagnostics (RESOURCE) (Page 84).

8.4.8 MENU TIMEOUT (4.8.)

Factory setting:	120 s
Setting range:	15 to 65535 s
Purpose:	Time menu stays visible before switching back to Measurement view if no key is pressed.

8.4.9 LCD BACKLIGHT (4.9.)

Factory setting:	128 seconds
Setting range:	0 (backlight off) to 128 seconds (>120 means backlight always on)
Purpose:	Time the backlight remains on.

8.4.10 LCD CONTRAST (4.10.)

Factory setting:	8
Setting range:	0 to 20
Purpose:	The factory setting is for optimum visibility at room temperature and in average light conditions. Extremes of temperature will lessen the contrast.
Description:	Contrast setting will depend on ambient temperature. Adjust the value to improve visibility in different temperatures and light conditions. Change the value in small steps to ensure you can continue to read the display.

8.4.11 SECONDARY VALUE (4.11.)

The value displayed in the secondary region of the LCD, in Measurement Mode, see The LCD display (Page 38), area (6) under Normal operation.

Use **Secondary Value** to capture the menu navigation path to a selected parameter, and store a custom secondary value, for example ECHO STRENGTH (2.4.7.2.) (Page 122).

While in Parameter View¹⁾ mode of the selected parameter, press the decimal point key. This stores the path to the selected parameter in **Secondary Value**, and displays that value in the secondary region of the LCD display when in Measurement Mode.

¹⁾ See **Parameter view** under The LCD display (Page 38).

8.4.12 SIMULATE ENABLE (4.12.)

Replaces a physical jumper switch found on some FF devices to enable simulation when set to ON. (Available only via local operation.)

Options	*	OFF	Simulation Disabled
		ON	Simulation Enabled

For more information on Simulation, see **Simulation (input)** under Operation (LTB) (Page 66) in AMS Device Manager, or the manual, *Foundation Fieldbus for Level Instruments (7ML19985MP01)*.

8.4.13 DEMO MODE (4.13.)

Factory setting:	OFF
Setting range:	ON or OFF
Purpose:	Used to set up for demonstrations: reduces the time between measurements and the accuracy for demonstration purposes.

8.4.14 STORED SOFTWARE VERSION (4.14.)

Displays the version string of the firmware previously uploaded to the local display (if any).

8.5 COMMUNICATION (5.)

8.5.1 TAG (5.1.)

The user-defined description for the device.

To access this parameter via AMS Device Manager see **Identification** under Identification (RESOURCE) (Page 80).

8.5.2 DEVICE ADDRESS (5.2.)

Note

The address can only be changed from a remote master such as NI-FBUS- Configurator or DeltaV. See the manual Foundation Fieldbus for Level instruments (7ML19985MP01) for more details.

Read only. The unique address of the device on the network.

Values Temporary range during initial commissioning: 248 - 251.
 Permanent range after commissioning complete (written to non-volatile memory in the device): 16-247

8.5.3 MANUFACTURER (5.3.)

Device manufacturer: Siemens.

8.5.4 DEVICE TYPE ID (5.4.)

Hexadecimal integer defined by Siemens to uniquely identify each product with manufacturer's Id. (LR560 FF device= 00D7.)

8.5.5 DEVICE REVISION (5.5.)

Manufacturer's revision number associated with this device.

8.5.6 ITK VERSION (5.6.)

Major revision number of the interoperability test case used to register this device.

8.6 SECURITY (6.)

8.6.1 REMOTE LOCKOUT (6.1.1.)

Note

If remote lockout control is changed to limit remote access, it can be reset only via the handheld programmer.

Enables or disables programming via the network and AMS Device Manager.

Options	*	OFF	Remote operation enabled
		ON	Remote operation disabled

8.6.2 WRITE PROTECT (6.2.1.)

Factory setting:	Unlock value (2457): Lock Off	
Setting range:	0 to 9999	
	Unlock value (2457)	Lock Off
	Any other value	Lock On
Purpose:	Prevents any changes to parameters.	
Description:	<ul style="list-style-type: none">• To turn Lock On, key in any value other than the Unlock Value 2457.• To turn Lock Off, key in the Unlock Value 2457.	

8.6.3 LOCAL OPERATION (6.2.2.)

Enables or disables programming via the handheld programmer.

Options	DISABLED
	* ENABLED

Note

Once disabled via the handheld programmer, the parameter is no longer visible on the local display and can only be reset using AMS Device Manager. However, if no communication activity exists for 30 seconds, the parameter will again be visible on the local display.

To access this parameter via AMS Device Manager see **Local display** under Setup (LCD) (Page 77).

8.7 LANGUAGE (7.)

Factory setting:	English
Setting range:	English, Deutsch, Français, Español, 简体中文
Purpose:	Selects the language to be used on the local display.

Service and maintenance

9.1 Basic safety notes

Note

The device is maintenance-free.

9.1.1 Maintenance

The device is maintenance-free. However, a periodic inspection according to pertinent directives and regulations must be carried out.

An inspection can include, for example, check of:

- Ambient conditions
- Seal integrity of the process connections, cable entries, and cover
- Reliability of power supply, lightning protection, and grounds

 WARNING
--

Impermissible repair and maintenance of the device

- | |
|--|
| <ul style="list-style-type: none"> • Repair and maintenance must be carried out by Siemens authorized personnel only. |
|--|

 WARNING
--

Impermissible repair of explosion protected devices
--

Risk of explosion in hazardous areas

- | |
|--|
| <ul style="list-style-type: none"> • Repair must be carried out by Siemens authorized personnel only. |
|--|

NOTICE

Penetration of moisture into the device
--

Device damage.

- | |
|---|
| <ul style="list-style-type: none"> • Make sure when carrying out cleaning and maintenance work that no moisture penetrates the inside of the device. |
|---|

 **WARNING**

Leaks in the sample gas path

Risk of poisoning.

When measuring toxic process media, these can be released or collect in the device if there are leaks in the sample gas path.

- Purge the device as described in Commissioning (Page 36).
- Dispose of the toxic process media displaced by purging in an environmentally friendly manner.

9.2 Cleaning

Cleaning the enclosure

- Clean the outside of the enclosure with the inscriptions and the display window using a cloth moistened with water or a mild detergent.
- Do not use any aggressive cleansing agents or solvents, e.g. acetone. Plastic parts or the painted surface could be damaged. The inscriptions could become unreadable.

 **WARNING**

Electrostatic charge

Risk of explosion in hazardous areas if electrostatic charges develop, for example, when cleaning plastic surfaces with a dry cloth.

- Prevent electrostatic charging in hazardous areas.

9.3 Maintenance and repair work

 **WARNING**

Maintenance during continued operation in a hazardous area

There is a risk of explosion when carrying out repairs and maintenance on the device in a hazardous area.

- Isolate the device from power.

- or -

- Ensure that the atmosphere is explosion-free (hot work permit).

 **WARNING**

Humid environment

Risk of electric shock.

- Avoid working on the device when it is energized.
- If working on an energized device is necessary, ensure that the environment is dry.
- Make sure when carrying out cleaning and maintenance work that no moisture penetrates the inside of the device.

 **CAUTION**

Hot surfaces

Risk of burns during maintenance work on parts having surface temperatures exceeding 70 °C (158 °F).

- Take corresponding protective measures, for example by wearing protective gloves.
- After carrying out maintenance, remount touch protection measures.

 **WARNING**

Enclosure open

Risk of explosion in hazardous areas as a result of hot components and/or charged capacitors inside the device.

To open the device in a hazardous area:

1. Isolate the device from power.
2. Observe the wait time specified in Technical data (Page 160) or on the warning sign before opening the device.
3. Visually inspect sensor inlet and outlet.

Exception: Devices exclusively having the type of protection "Intrinsic safety Ex i" may be opened in an energized state in hazardous areas.

 **CAUTION**

Hazardous voltage at open device

Risk of electric shock when the enclosure is opened or enclosure parts are removed.

- Before you open the enclosure or remove enclosure parts, de-energize the device.
- If maintenance measures in an energized state are necessary, observe the particular precautionary measures. Have maintenance work carried out by qualified personnel.

 **WARNING**

Hot, toxic or corrosive process media

Risk of injury during maintenance work.

When working on the process connection, hot, toxic or corrosive process media could be released.

- As long as the device is under pressure, do not loosen process connections and do not remove any parts that are pressurized.
- Before opening or removing the device ensure that process media cannot be released.

 **WARNING**

Improper connection after maintenance

Risk of explosion in areas subject to explosion hazard.

- Connect the device correctly after maintenance.
- Close the device after maintenance work.

Refer to Connecting (Page 28).

9.4 Return procedure

Enclose the bill of lading, return document and decontamination certificate in a clear plastic pouch and attach it firmly to the outside of the packaging.

Required forms

- Delivery note
- Return goods delivery note (<http://www.siemens.com/processinstrumentation/returngoodsnote>)
with the following information:
 - Product (item description)
 - Number of returned devices/replacement parts
 - Reason for returning the item(s)
- Decontamination declaration (<http://www.siemens.com/sc/declarationofdecontamination>)

With this declaration you warrant "that the device/replacement part has been carefully cleaned and is free of residues. The device/replacement part does not pose a hazard for humans and the environment."

If the returned device/replacement part has come into contact with poisonous, corrosive, flammable or water-contaminating substances, you must thoroughly clean and decontaminate the device/replacement part before returning it in order to ensure that all hollow areas are free from hazardous substances. Check the item after it has been cleaned.

Any devices/replacement parts returned without a decontamination declaration will be cleaned at your expense before further processing.

Note

Return of products with lithium batteries

Lithium batteries are dangerous goods according to the Regulation of Dangerous Goods, UN 3090 and UN 3091.

- Remove lithium batteries prior to shipment.
 - If the battery cannot be removed, return the product according to the Regulation of Dangerous Goods with special transport documentation.
-

9.5

Disposal



Devices described in this manual should be recycled. They may not be disposed of in the municipal waste disposal services according to the Directive 2012/19/EC on waste electronic and electrical equipment (WEEE).















Devices can be returned to the supplier within the EC, or to a locally approved disposal service for eco-friendly recycling. Observe the specific regulations valid in your country.

Further information about devices containing batteries can be found at:
Information about battery / product return (WEEE)

<https://support.industry.siemens.com/cs/document/109479891>)

Diagnosing and troubleshooting







10.1 Device status icons











Icon	Priority Level	Meaning
	1	<ul style="list-style-type: none"> Maintenance alarm Measurement values are not valid
	2	<ul style="list-style-type: none"> Maintenance warning: maintenance demanded immediately Measured signal still valid
	3	<ul style="list-style-type: none"> Maintenance required Measured signal still valid
	1	<ul style="list-style-type: none"> Process value has reached an alarm limit
	2	<ul style="list-style-type: none"> Process value has reached a warning limit
	3	<ul style="list-style-type: none"> Process value has reached a tolerance limit
	1	<ul style="list-style-type: none"> Configuration error Device will not work because one or more parameters/components is incorrectly configured
	2	<ul style="list-style-type: none"> Configuration warning Device can work but one or more parameters/components is incorrectly configured
	3	<ul style="list-style-type: none"> Configuration changed Device parameterization not consistent with parameterization in project. Look for info text.
	1	<ul style="list-style-type: none"> Manual operation (local override) Communication is good; device is in manual mode.
	2	<ul style="list-style-type: none"> Simulation or substitute value Communication is good; device is in simulation mode or works with substitute values.
	3	<ul style="list-style-type: none"> Out of operation Communication is good; device is out of action.
		<ul style="list-style-type: none"> No data exchange
		<ul style="list-style-type: none"> Write access enabled
		<ul style="list-style-type: none"> Write access disabled







10.2 General fault codes

Note

- The status icon shown associated with each fault is the default icon in Condensed Mode.
- If more than one fault is present, the device status indicator and text for each fault alternate at 2 second intervals.
- Some faults cause the device to go to Fail-safe mode (Fault 52). These are indicated with an asterisk (*).
- If you receive an LOE error communicated via the communications bus, double-check the local display prior to contacting the service department. Occasionally the device will show a hardware fault (S96) that is reported through the bus as an LOE. In such a case, the device electronics will need to be replaced.





Code/ Icon		Meaning	Corrective Action
S: 0 	*	The device was unable to get a measurement within the Fail-safe LOE Timer period. Possible causes: faulty installation, antenna material buildup, foaming/other adverse process conditions, invalid configuration range.	<ul style="list-style-type: none"> • Ensure installation details are correct. • Ensure no antenna material buildup. Clean if necessary. • Adjust process conditions to minimize foam or other adverse conditions. • Correct configuration range. • If fault persists, contact your local Siemens representative.
S: 2 	*	Unable to collect profile because of a power condition that is outside the operating range of the device.	Repair required: contact your local Siemens representative.
S: 3 		Device is nearing its lifetime limit according to the value set in REMINDER 1 (REQUIRED) (4.2.5.) (Page 136).	Replacement is recommended.
S: 4 		Device is nearing its lifetime limit according to the value set in REMINDER 2 (DEMANDED) (4.2.6.) (Page 136).	Replacement is recommended.
S: 6 		Sensor is nearing its lifetime limit according to the value set in REMINDER 1 (REQUIRED) (4.3.5.) (Page 138).	Replacement is recommended.
S: 7 		Sensor is nearing its lifetime limit according to the value set in REMINDER 2 (DEMANDED) (4.3.6.) (Page 138).	Replacement is recommended.
S: 8 		Service interval as defined in REMINDER 1 (REQUIRED) (4.4.5.) (Page 140) has expired.	Perform service.

Code/ Icon		Meaning	Corrective Action
S: 9 		Service interval as defined in REMINDER 2 (DEMANDED) (4.4.6.) (Page 140) has expired.	Perform service.
S: 10 		Input parameters LOW CALIBRATION POINT (2.3.5.1.) (Page 114) and HI CALIBRATION POINT (2.3.5.2.) (Page 114) are the same.	<ul style="list-style-type: none"> • Check calibration settings of device. • Ensure settings for High Calibration Point and Low Calibration Point are different.
S: 11 		Internal temperature sensor failure.	Repair required: contact your local Siemens representative.
S: 12 		Internal temperature of device has exceeded specifications: it is operating outside its temperature range.	<ul style="list-style-type: none"> • Relocate device and/or lower process temperature enough to cool device. • Inspect for heat-related damage and contact your local Siemens representative if repair is required. • Fault code will persist until a manual reset is performed using SIMATIC PDM or the LCD interface.
S: 14 		INPUT SCALING (2.5.4) (Page 128) Upper and lower values for AIFB1 are the same.	<ul style="list-style-type: none"> • Check configuration for AIFB1. • Ensure that Upper Value and Lower Value (Input Scaling) are not the same.
S: 15 		INPUT SCALING (2.5.4) (Page 128) Upper and lower values for AIFB2 are the same.	<ul style="list-style-type: none"> • Check configuration for AIFB2. • Ensure that Upper Value and Lower Value (Input Scaling) are not the same.
S: 17 		Calibration interval as defined in REMINDER 1 (REQUIRED) (4.5.5.) (Page 142) has expired.	Perform calibration.
S: 18 		Calibration interval as defined in REMINDER 2 (DEMANDED) (4.5.6.) (Page 142) has expired.	Perform calibration.
S: 25 		Internal error.	Reset power. If fault persists, contact your local Siemens representative.
S: 28 	*	Internal device failure caused by a RAM memory error.	Repair required: contact your local Siemens representative.
S: 29 	*	EEPROM damaged.	Repair required: contact your local Siemens representative.

Code/ Icon		Meaning	Corrective Action
S: 30 		EEPROM corrupt.	Reset power. If fault persists, contact your local Siemens representative.
S: 31 	*	Flash error.	Repair required: contact your local Siemens representative.
S: 32 		IDENT number conflict.	Ensure value of the Ident number selector is correct for the network configuration. If it is correct, the device needs to be re parameterized by the PLC.
S: 33 	*	Factory calibration for the internal temperature sensor has been lost.	Repair required: contact your local Siemens representative.
S: 34 	*	Factory calibration for the device has been lost.	Repair required: contact your local Siemens representative.
S: 64 to S:83 		Device error. NOTE: Fault text and icons appear only on LCD.	Repair required: contact your local Siemens representative.
S: 94 to S:112 		Device error. NOTE: Fault text and icons appear only on LCD.	Repair required: contact your local Siemens representative.

10.3 Operation troubleshooting

Operating symptoms, probable causes, and resolutions.

Symptom	Cause	Action
Display shows  S: 0 LOE	level or target is out of range	<ul style="list-style-type: none"> check specifications check LOW CALIBRATION POINT (2.3.5.1.) (Page 114). increase CONFIDENCE (2.4.7.1.) (Page 122).
Display shows  S: 0 LOE	material build-up on antenna	<ul style="list-style-type: none"> Use the air purge feature to clean the antenna re-locate SITRANS LR560.
Display shows  S: 0 LOE	location or aiming: <ul style="list-style-type: none"> poor installation flange not level Auto False Echo Suppression may be incorrectly applied 	<ul style="list-style-type: none"> check to ensure nozzle is vertical ensure end of antenna protrudes from end of nozzle review MAXIMUM MEASURED VALUE (3.5.2.) (Page 134) ensure Auto False Echo Suppression Range is set correctly
Display shows  S: 0 LOE	antenna malfunction: <ul style="list-style-type: none"> temperature too high physical damage 	<ul style="list-style-type: none"> check temperature in MAXIMUM VALUE (3.4.2.) (Page 133). relocate
Reading does not change, but the level does	SITRANS LR560 processing wrong echo, for example, vessel wall, or structural member	<ul style="list-style-type: none"> re-locate SITRANS LR560 check nozzle for internal burrs or welds rotate device 90° use AUTO ECHO SUPPRESSION (2.4.8.1.) (Page 123) if necessary.
Measurement is consistently off by a constant amount	<ul style="list-style-type: none"> setting for LOW CALIBRATION POINT (2.3.5.1.) (Page 114) not correct setting for SENSOR OFFSET (2.3.5.3.) (Page 115) not correct 	<ul style="list-style-type: none"> check distance from sensor reference point to LOW CALIBRATION POINT (2.3.5.1.) (Page 114) check SENSOR OFFSET (2.3.5.3.) (Page 115)
Screen blank	power error	<ul style="list-style-type: none"> check nameplate rating against voltage supply check power wiring or source
Reading erratic	echo confidence weak	<ul style="list-style-type: none"> refer to CONFIDENCE (2.4.7.1.) (Page 122). use AUTO ECHO SUPPRESSION (2.4.8.1.) (Page 123) and AUTO SUPPRESSION RANGE (2.4.8.2.) (Page 125) use foam deflector or stillpipe
	material filling	<ul style="list-style-type: none"> Re-locate SITRANS LR560.
Reading response slow	FILL RATE/MIN (2.3.6.2.) (Page 116) setting incorrect	<ul style="list-style-type: none"> increase measurement response if possible

Symptom	Cause	Action
Reads correctly but occasionally reads high when vessel is not full	<ul style="list-style-type: none"> detecting close range echo build up near top of vessel or nozzle nozzle problem 	<ul style="list-style-type: none"> Use the air purge feature to clean the antenna use AUTO ECHO SUPPRESSION (2.4.8.1.) (Page 123) and AUTO SUPPRESSION RANGE (2.4.8.2.) (Page 125).
Level reading lower than material level	<ul style="list-style-type: none"> material is within Near Range zone multiple echoes processed 	<ul style="list-style-type: none"> decrease NEAR RANGE (2.4.1.) (Page 117) (minimum value depends on antenna type) raise SITRANS LR560 ensure ALGORITHM (2.4.5.1.) (Page 119) is set to TF (First echo)

10.4 Communication Troubleshooting

- Check the following:
 - There is power at the instrument.
 - The local display shows the relevant data.
 - The device can be programmed using the handheld programmer.
 - If any fault codes are being displayed see General fault codes (Page 155) for a detailed list.
- Verify that the wiring connections are correct.
- See the table below for specific symptoms.

Symptom	Corrective action
The device cannot be programmed via the handheld programmer.	Make sure WRITE PROTECT (6.2.1.) (Page 146) is set to the unlock value, and that LOCAL OPERATION (6.2.2.) (Page 146) is enabled.
You try to set a SITRANS LR560 parameter via remote communications but the parameter remains unchanged.	<ul style="list-style-type: none"> Ensure REMOTE LOCKOUT (6.1.1.) (Page 146) is disabled. Ensure WRITE PROTECT (6.2.1.) (Page 146) is set to the unlock value.
The controller value equals the display value but does not correspond to actual material level.	<ul style="list-style-type: none"> Ensure Scaling in AIFB 1 is correctly entered. Ensure High Calibration Point is correctly entered. View the echo profile to see if the wrong echo is being selected. If so, see Operation troubleshooting (Page 158) for possible causes and corrective action.
The controller value is not equal to the displayed value (regardless of actual material level).	<ul style="list-style-type: none"> Confirm you are looking at the right spot in the controller. Ensure scaling has not been programmed into the controller: all scaling should be performed by the LR560. Check the network to ensure the controller is communicating with the LR560.
Only the AIFB 1 and AIFB 2 parameters are displayed via local display	<ul style="list-style-type: none"> Ensure LOCAL OPERATION (6.2.2.) (Page 146) is enabled
Not able to change parameters, such as low calibration point	<ul style="list-style-type: none"> Ensure block is set to Out of Service (O/S)

If you continue to experience problems, go to our website (www.siemens.com/LR560) and check the FAQs for SITRANS LR560, or contact your Siemens Milltronics representative.

Technical data

Note

Device specifications

Siemens makes every attempt to ensure the accuracy of these specifications but reserves the right to change them at any time.

11.1 Power

Bus powered	9 to 32 V DC, per IEC 61158-2 (Foundation Fieldbus)
Current consumed	13.5 mA

11.2 Performance

Measurement Accuracy¹⁾ (measured in accordance with IEC 60770-1)

Maximum measured error	5 mm (0.2") including hysteresis and non-repeatability ²⁾	
Frequency	78 to 79 GHz FMCW	
Maximum measurement range ³⁾	40 m version	40 m (131 ft)
	100 m version	100 m (328 ft)
Minimum detectable distance	400 mm (15.7") from sensor reference point ⁴⁾	
Update time ⁵⁾	maximum 10 seconds, depending on setting for RESPONSE RATE (2.3.6.1.) (Page 116)	
Influence of ambient temperature	< 0.003%/K (average over full temperature range, referenced to maximum range)	
Long-term stability	<0.1%/24 months	
Dielectric constant of material measured	for ranges up to 20 m (65.6 ft)	minimum dK = 1.6
	for ranges up to 100 m (328 ft)	minimum dK = 2.5
Memory	non-volatile EEPROM	
	no battery required	

¹⁾ Reference conditions: POSITION DETECT (2.4.5.2.) (Page 119) set to Center and ALGORITHM (2.4.5.1.) (Page 119) set to True First Echo.

²⁾ Under severe EMI/EMC environments per IEC61326-1 or NAMUR NE21, the device error may increase to a maximum of 25mm (1").

³⁾ From sensor reference point.

⁴⁾ See Dimension drawings (Page 165).

⁵⁾ Reference conditions: RESPONSE RATE (2.3.6.1.) (Page 116) set to **FAST**

11.3 Construction

Process connection:	Universal flat-faced flange ¹⁾	3"/80 mm, 4"/100 mm, 6"/150 mm Material: 316L (1.4404 or 1.4435), or 304 stainless steel
	Aimer flange ¹⁾	3"/80 mm, 4"/100 mm, 6"/150 mm Material: Polyurethane powder-coated cast aluminum
	Universal stamped flange ¹⁾	3"/80 mm, 4"/100 mm, 6"/150 mm Material: 304 stainless steel
Enclosure	Construction	316L/1.4404 stainless steel
	Conduit entry	M20x1.5, or ½" NPT
	Conduit entry connector (optional)	M12 connector (shipped with M20 to M12 adaptor) or, 7/8" connector (shipped with 1/2" NPT to 7/8" adaptor)
	Ingress protection	Type 4X, Type 6, IP68
	Lid with window	Polycarbonate (window material)
	Sun shield (optional)	304 stainless steel
Lens antenna material	40 m version	PEI
	100 m version	PEEK
Air purge connection	equipped with female 1/8" NPT fitting	
Weight (excluding extensions):	3" stainless steel flange model	3.15 kg (6.94 lb)

¹⁾ Universal flange mates with EN 1092-1 (PN16)/ASME B16.5 (150 lb)/JIS 2220 (10K) bolt hole pattern.

11.4 Operating conditions

Note

- For the specific configuration you are about to use or install, check transmitter nameplate and see Approvals data (Page 163).
- Use appropriate conduit seals to maintain IP or NEMA rating.

Location	indoor/outdoor
Altitude	5000 m (16,404 ft) max.
Ambient temperature	-40 to +80 °C (-40 to +176 °F)
Storage temperature	-40 to +80 °C (-40 to +176 °F)
Relative humidity	suitable for outdoor use Type 4X, Type 6, IP68 enclosure (see note above)
Installation category	I
Pollution degree	4

Reference operating conditions according to IEC 60770-1

Ambient temperature	15 to 25 °C (59 to 77 °F)
Humidity	45 to 75% relative humidity
Ambient pressure	860 to 1060 mbar a (86000 to 106000 N/m ² g)

11.5 Process

Temperature and pressure¹⁾

Note

Pressure

Universal stamped flanges are to be used for 0.5 bar max pressure only.

Version	Stainless steel flange	Aimer flange 0.5 bar max.	Aimer flange 3.0 bar max
40 m	-40 to +100 °C (-40 to +212 °F)	-40 to +100 °C (-40 to +212 °F)	-40 to +100 °C (-40 to +212 °F)
100 m	-40 to +200 °C (-40 to +392 °F)	-40 to +200 °C (-40 to +392 °F)	-40 to +120 °C (-40 to +248 °F)

¹⁾ Maximum and minimum temperatures are dependent on the process connection, antenna and O-ring materials. Use of the Easy Aimer limits maximum temperature.

11.6 Approvals data

Note

Approvals

The device label lists the approvals that apply to your device.

General			CSA _{US/IC} , FM, CE, RCM
Radio			Europe (RED), FCC, Industry Canada
Hazardous	Non-sparking/Energy Limited	Eu- rope/International	ATEX II 3G Ex nA/nL IIC T4 Gc
		Brazil	INMETRO: DNV 12.0085 X Ex nA IIC T4 Gc -40 °C ≤ Ta ≤ +80 °C Un = 32 Vcc
		China	Ex nA IIC T4 Gc
	Dust Ignition Proof	Eu- rope/International	ATEX II 1D, 1/2D, 2D Ex ta IIIC T139 °C Da IP68 IECEX SIR 09.0149X
		Brazil	INMETRO: DNV 12.0085 X Ex ta IIIC T139 °C Da IP68 -40 °C ≤ Ta ≤ +80 °C
		China	Ex tD A20 IP68 T139°C
	Dust Ignition Proof	US/Canada	FM/CSA: Class II, Div. 1, Groups E, F, G Class III T4
	Non-incendive	US/Canada	FM/CSA Class I, Div. 2, Groups A, B, C, D, T4
CE Electromagnetic Compatibility (EMC) conformity			
Emission		EN 55011 / CISPR-11	
Immunity		EN/IEC 61326-1 (Industry) NAMUR NE 21	

11.7 Communication: Foundation Fieldbus

Communication	Foundation Fieldbus
ITK version 5	Blocks supported: RESOURCE, LTB, AIFB1, AIFB2, LCD, DIAG Block execution time: AIFB - 30 ms

11.8 Programmer (infrared keypad)

The battery is non-replaceable with a lifetime expectancy of 10 years in normal use. To estimate the lifetime expectancy, check the nameplate on the back for the serial number. The date of manufacture is encoded in the serial number. For example, the following was manufactured on March 5, 2016:

PBD/H3050001

H: year of manufacture (H is the alpha code referring to 2016; J refers to 2017 and so on).

3: month of manufacture

05: day of manufacture

0001: 4-digit sequential

Year 2010: Alpha code = A Year 2016: Alpha code = H

Year 2011: Alpha code = B Year 2017: Alpha code = J

Year 2012: Alpha code = C Year 2018: Alpha code = K

Year 2013: Alpha code = D Year 2019: Alpha code = L

Year 2014: Alpha code = E Year 2020: Alpha code = M

Year 2015: Alpha code = F

Siemens Milltronics Infrared IS (Intrinsically Safe) Handheld Programmer for hazardous and all other locations (battery is non-replaceable).

Approvals	CE FM/CSA Class I, II, III, Div. 1, Gr. A to G T6 ATEX 1 GD Ex ia op is IIC T4 Ga Ex ia op is IIIC T135°C Da IECEX Ex ia op is IIC T4 Ga Ex ia op is IIIC T135°C Da INMETRO Ex ia op is IIC T4 Ga Ex ia op is IIIC T135°C Da
Ambient temperature	-20 to +50 °C (-5 to +122 °F)
Interface	proprietary infrared pulse signal
Power	3 V non-replaceable lithium battery
Weight	150 g (0.3 lb)
Color	black
Part number	7ML1930-1BK

Dimension drawings

12.1 SITRANS LR560 with stainless steel universal flat-faced flange

Note

Bolt hole patterns and dimensions

Refer to Universal slotted flange (Page 169) for bolt hole patterns and dimensions.

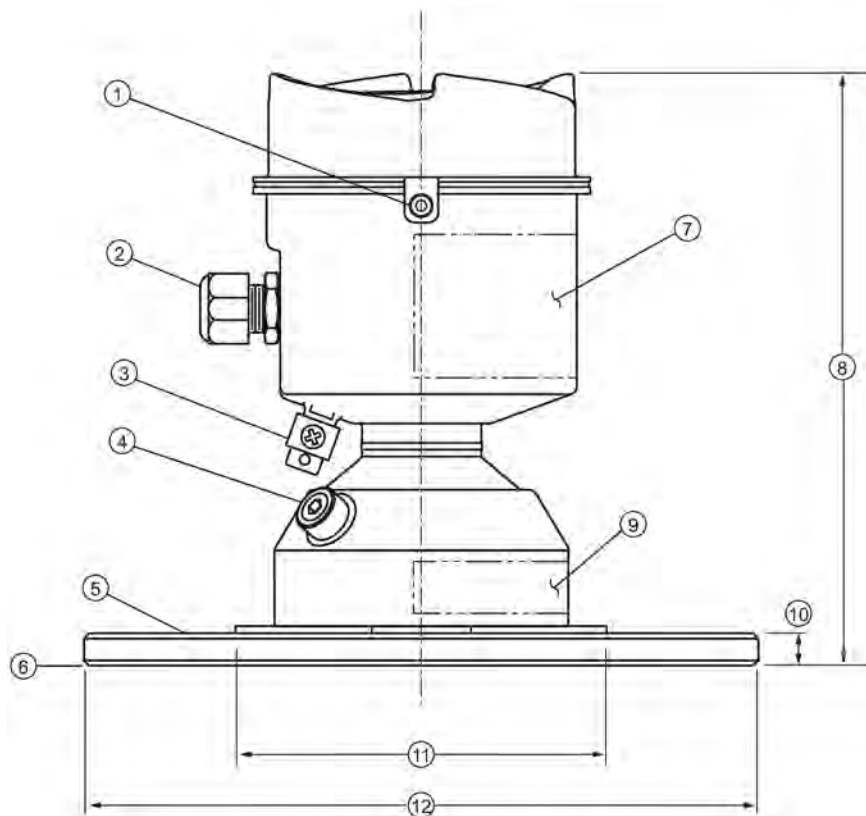

Dimensions are in mm (inch)

- | | |
|------------------------------|--|
| ① lid lock | ⑧ height: 176 (6.93) |
| ② cable gland ¹⁾ | ⑨ pressure/temperature related information |
| ③ grounding lug | ⑩ thickness: 9.6 (0.38) |
| ④ purge inlet | ⑪ 110 (4.33) |
| ⑤ process connection, flange | ⑫ flange OD: |
| ⑥ sensor reference point | 3": 200 (7.87) |
| ⑦ device label | 4": 229 (9.02) |
| | 6": 285 (11.22) |

¹⁾ Shipped with product, packed in a separate bag.

12.2 SITRANS LR560 with 3" aimer flange

Note

Bolt hole patterns and dimensions

Refer to Universal slotted flange (Page 169) for bolt hole patterns and dimensions.

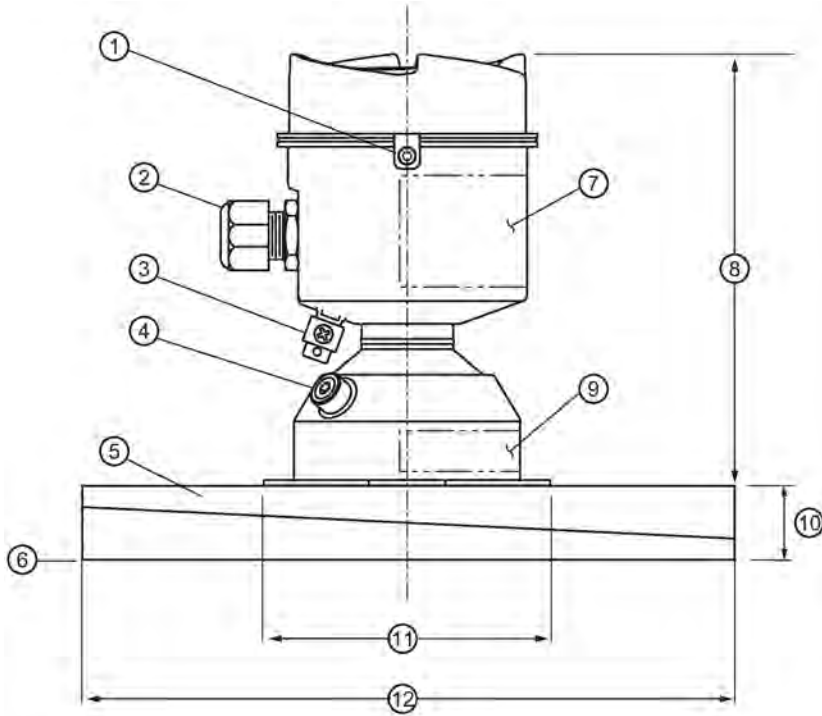

Dimensions are in mm (inch)

- | | |
|------------------------------------|--|
| ① lid lock | ⑦ device label |
| ② cable gland ¹⁾ | ⑧ height: 166.1 (6.54) |
| ③ grounding lug | ⑨ pressure/temperature related information |
| ④ purge inlet | ⑩ thickness: 23.3 (0.92) |
| ⑤ process connection, aimer flange | ⑪ 110 (4.33) |
| ⑥ sensor reference point | ⑫ flange OD: 200 (7.87) |

¹⁾ Shipped with product, packed in a separate bag.

12.3 SITRANS LR560 with 4" and 6" aimer flange

Note

Bolt hole patterns and dimensions

Refer to Universal slotted flange (Page 169) for bolt hole patterns and dimensions.

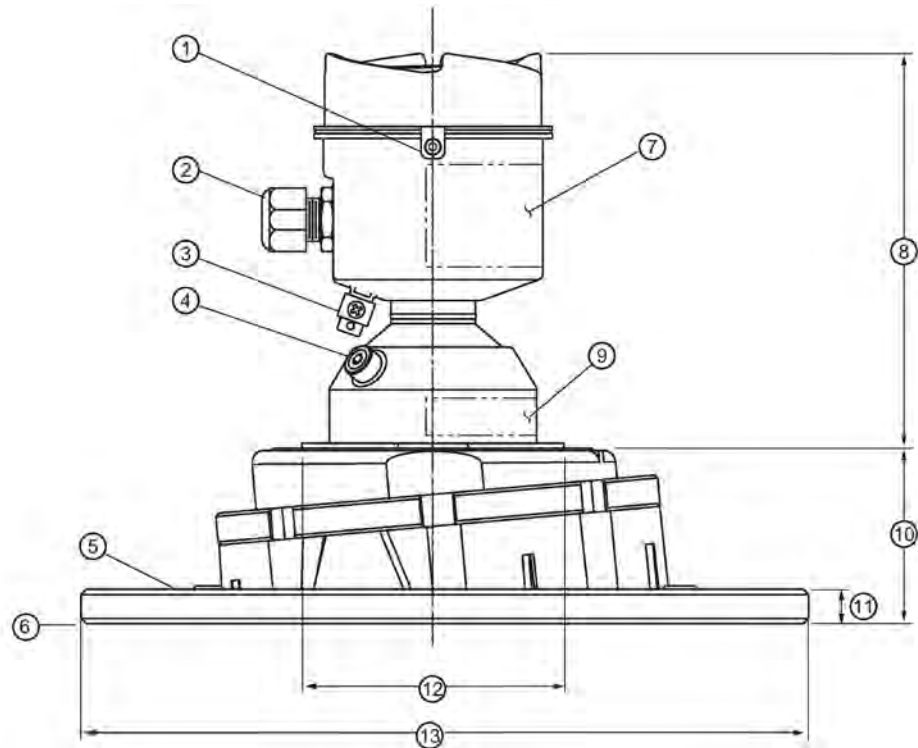

Dimensions are in mm (inch)

① lid lock	⑧ 166.1 (6.54)
② cable gland ¹⁾	⑨ pressure/temperature related information
③ grounding lug	⑩ 4": 53.2 (2.09)
	6": 60.0 (2.36)
④ purge inlet	⑪ 9.6 (0.38)
⑤ process connection: aimer flange	⑫ 110 (4.33)
⑥ sensor reference point	⑬ 4": 229 (9.02)
⑦ device label	6": 285 (11.22)

¹⁾ Shipped with product, packed in a separate bag.

C Spanner

A C spanner, used to loosen the aimer locking ring, is shipped with the device, packed separately.



12.4 SITRANS LR560 with stamped flange

Note

Bolt hole patterns and dimensions

Refer to Stamped flange (Page 171) for bolt hole patterns and dimensions.

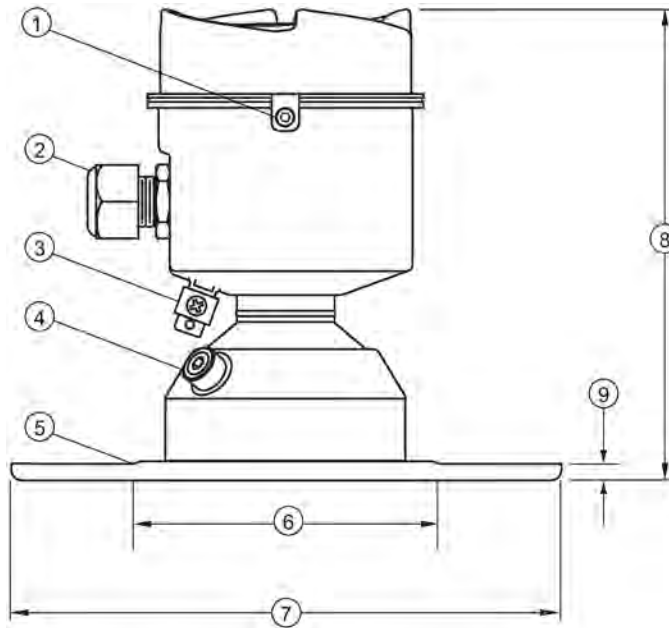

Dimensions in mm (inch)

- | | |
|--------------------------------------|------------------------------|
| ① lid lock | ⑥ 110 (4.33) |
| ② cable gland ¹⁾ | ⑦ flange OD: |
| | 2": 200 (7.87) |
| | 3": 234 (9.21) |
| | 6": 290 (11.42) |
| ③ grounding lug | ⑧ height: 176 (6.93) |
| ④ purge inlet | ⑨ flange thickness: 6 (0.24) |
| ⑤ process connection, stamped flange | |

¹⁾ Shipped with product, packed in a separate bag.

12.5 Universal slotted flange

Note

Bolting and gasket materials

The user is responsible for the selection of bolting and gasket materials which will fall within the limits of the flange and its intended use and which are suitable for the service conditions.

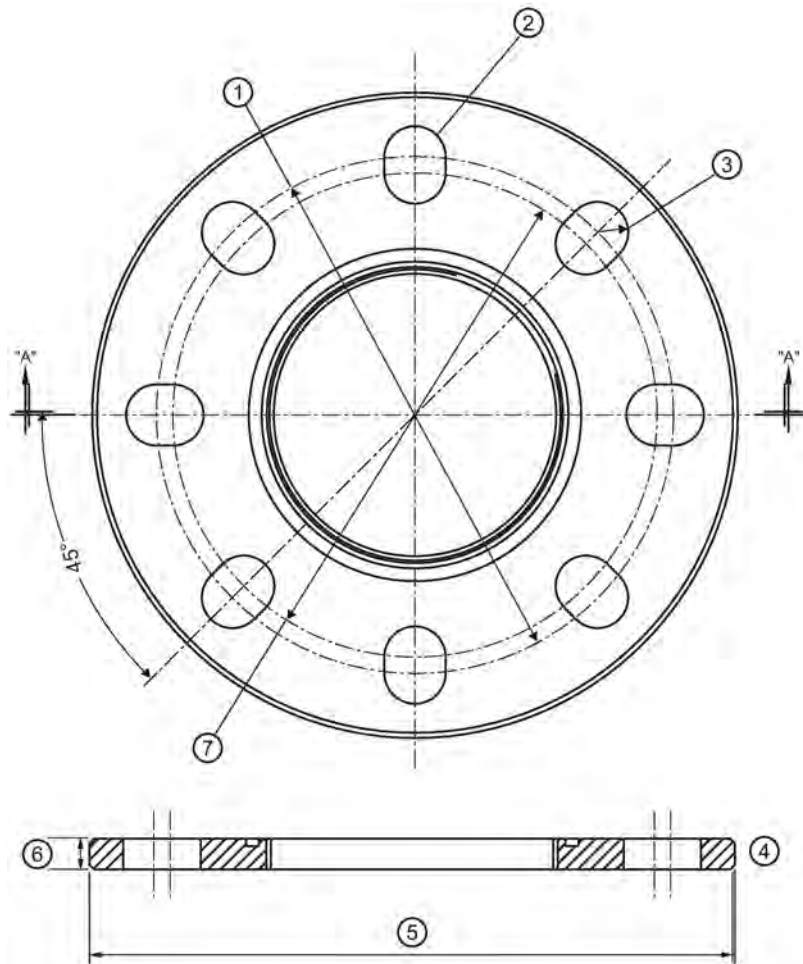

① bolt hole circle max. diameter

② number of slotted bolt holes

③ bolt hole radius

④ section A-A

⑤ flange O.D.

⑥ thickness

⑦ bolt hole circle min. diameter

Slotted flange dimensions and aimer¹⁾

Pipe size	Flange O.D.	Thickness	Bolt hole circle max Ø	Bolt hole circle min Ø	Bolt hole radius	No. of slotted holes
3 (80)	7.87 (200)	0.38 (9.65)	6.30 (160)	5.91 (150)	0.37 (9.5)	8
4 (100)	9.00 (229)	0.38 (9.65)	7.52 (191)	6.89 (175)	0.37 (9.5)	8
6 (150)	11.22 (285)	0.38 (9.65)	9.53 (242)	9.45 (240)	0.45 (11.5)	8

Dimensions are in inch (mm)

¹⁾ Universal flange mates with EN 1092-1 (PN16)/ASME B16.5 (150 lb)/JIS 2220 (10K) bolt hole pattern.

12.6 Stamped flange

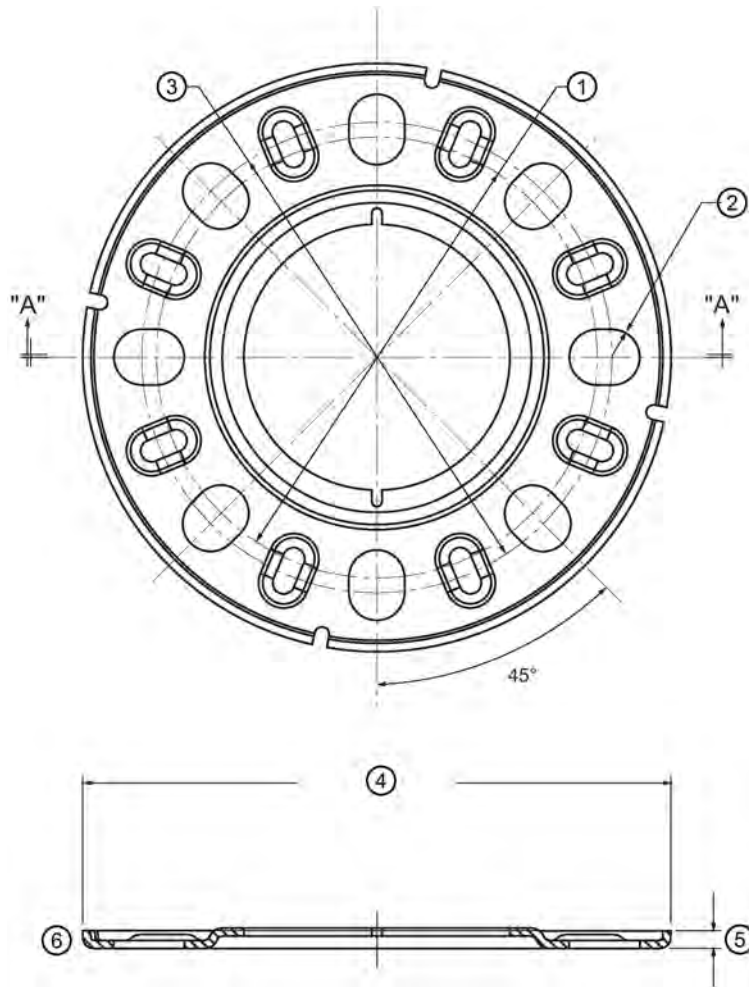

- | | |
|----------------------------------|---------------|
| ① bolt hole circle min. diameter | ④ flange OD |
| ② bolt hole radius | ⑤ thickness |
| ③ bolt hole circle max. diameter | ⑥ section A-A |

Stamped flange dimensions

Pipe size	Flange O.D.	Thickness	Bolt hole circle max Ø	Bolt hole circle min Ø	Bolt hole radius	No. of slotted holes
3 (80)	7.87 (200)	6.0 (0.24)	6.30 (160)	5.91 (150)	0.37 (9.5)	8
4 (100)	9.21 (234)	6.0 (0.24)	7.52 (191)	6.89 (175)	0.37 (9.5)	8
6 (150)	11.42 (290)	6.0 (0.24)	9.53 (242)	9.45 (240)	0.45 (11.5)	8

Dimensions in inch (mm)

12.7 Process connection label (pressure rated versions)

For pressure-rated versions only, the process connection label lists the following information:

Item	Sample Text	Comments/Explanation
CONNECTION SERIES	ASME B16.5 / EN 1092-1/ JIS B 2220	Flange Series: dimensional pattern based on ASME B16.5/EN 1092-1/JIS B 2 220 flange standards
NOM. PIPE SIZE (DN)	4 INCH / 100mm	Nominal Pipe Size: based on 150#/PN16/10K flange pressure classes
MAWP (PS)	3 BAR	Maximum Allowable Working Pressure at Design Temperature
DESIGN TEMP. (TS)	100 °C	Maximum Allowable Working Temperature
MIN. PROCESS	3 BAR AT -40 °C	Minimum Wetted Process Conditions
0F13589.5		Canadian Registration Number (CRN)
TEST PRESSURE (PT)	5.2 BAR	Production Test Pressure
TEST DATE	10/01/04	Date of Pressure Test (Year/Month/Day)
PROCESS SERIES	25785	Pressure Tag Family Series
WETTED NON-METALLIC	PEI	Sensor Lens Material
WETTED METALLICS	304L	Process Connection Material(s)
WETTED SEALS	FKM / VQM	Seal Material(s)

Technical reference

A.1 Principles of operation

SITRANS LR560 is a 2-wire, 78 GHz FMCW (Frequency Modulated Continuous Wave) radar level transmitter for continuous monitoring of solids and liquids in vessels to a range of 100 m (329 ft)¹⁾. Radar level measurement uses the time of flight principle to determine distance to a material surface.

FMCW radar transmits a continuous wave. The frequency of the wave is constantly increasing; this is known as the sweep. By the time the first part of the wave has been reflected off the target and returned to the device, the part of the wave that is just being emitted is at a higher frequency. The difference in frequency between the transmitted and received signals is proportional to time of flight.

Electromagnetic wave propagation is virtually unaffected by temperature or pressure changes, or by changes in the vapor levels inside a vessel. Electromagnetic waves are not attenuated by dust.

SITRANS LR560 consists of an enclosed electronic circuit coupled to an antenna and process connection. The electronic circuit generates a radar signal (78 GHz) that is directed to the lens antenna.

The signal is emitted from the lens antenna, and the reflected echoes are digitally converted to an echo profile. The profile is analyzed to determine the distance from the sensor reference point²⁾ to the material surface. This value (sensor value) is used as a basis for calculating the display of material level and mA output.

¹⁾ The microwave output level is significantly less than that emitted from cellular phones.

²⁾ See Dimension drawings (Page 165)

A.2 Process variables

The Process Variables are sensor value and measured value. Sensor value is the distance from the sensor reference point (flange face) to the material surface. The measured value can be either Level (distance from low calibration point to material surface), Distance (distance from sensor reference point to the material surface), or Space (distance from high calibration point to the material surface).

A.3 Echo processing

A.3.1 Process Intelligence

The signal processing technology embedded in Siemens radar level devices is known as **Process Intelligence**.

Process intelligence provides high measurement reliability regardless of the dynamically changing conditions within the vessel being monitored. The embedded Process Intelligence dynamically adjusts to the constantly changing material surfaces within these vessels.

Process Intelligence is able to differentiate between the true microwave reflections from the surface of the material and unwanted reflections being returned from obstructions such as seam welds or supports within a vessel. The result is repeatable, fast and reliable measurement. This technology was developed as result of field data gained over some twenty years from more than 1,000,000 installations in many industries around the world.

Higher order mathematical techniques and algorithms are used to provide intelligent processing of microwave reflection profiles. This "knowledge based" technique produces superior performance and reliability.

A.3.2 Echo selection

Time Varying Threshold (TVT)

A Time Varying Threshold (TVT) hovers above the echo profile to screen out unwanted reflections (false echoes).

In most cases the material echo is the only one which rises above the default TVT.

In a vessel with obstructions, a false echo may occur, see AUTO ECHO SUPPRESSION (2.4.8.1.) (Page 123) for more details.

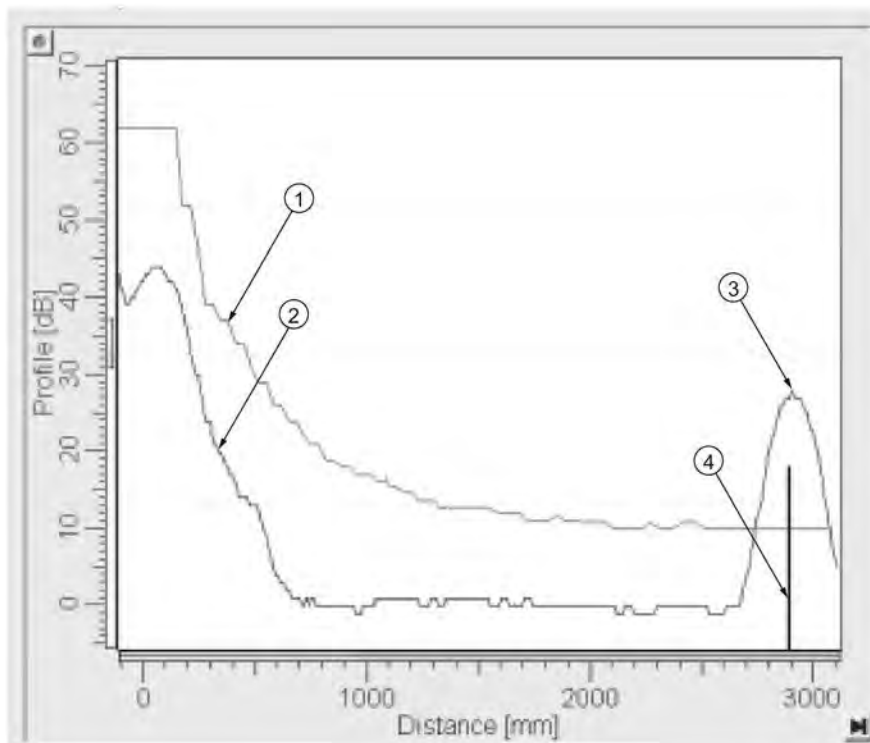

- ① default TVT
- ② echo profile
- ③ material level
- ④ echo marker

The device characterizes all echoes that rise above the TVT as potential good echoes. Each peak is assigned a rating based on its strength, area, height above the TVT, and reliability, amongst other characteristics.

ALGORITHM (2.4.5.1.) (Page 119)

The true echo is selected based on the setting for the Echo selection algorithm. For a list of options, see ALGORITHM (2.4.5.1.) (Page 119).

POSITION DETECT (2.4.5.2.) (Page 119)

The echo position detection algorithm determines which point on the echo will be used to calculate the precise time of flight, and calculates the range using the calibrated propagation velocity. The following options are available:

Rising: Uses rising edge of the echo.

Center: Uses center of the echo.

Hybrid: Uses the Center algorithm for the top part of the vessel, and the CLEF algorithm for the part nearest the vessel bottom, according to the setting for **CLEF range**.

CLEF (Constrained Leading Edge Fit)

- Uses the leading edge of the echo.
- Is used mainly to process the echo from materials with a low dK value.

In an almost empty flat-bottomed vessel, a low dK material may reflect an echo weaker than the echo from the vessel bottom. The echo profile shows these echoes merging. The device may then report a material level equal to or lower than empty.

The CLEF algorithm enables the device to report the level correctly.

Example: CLEF off: Position set to Hybrid

Vessel height: 1.5 m; CLEF range set to 0 (Center algorithm gives the same result.)

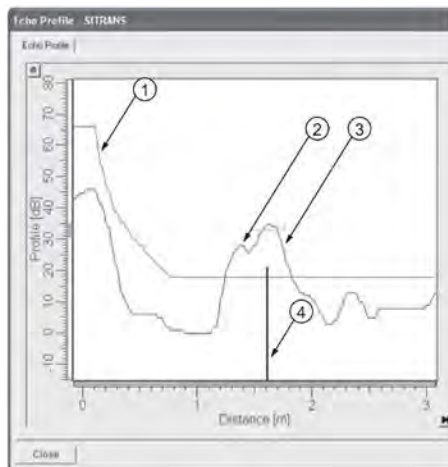

- ① default TVT
- ② material echo
- ③ vessel bottom echo selected
- ④ echo marker

Example: CLEF enabled

Vessel height: 1.5 m; CLEF range set to 0.5 m

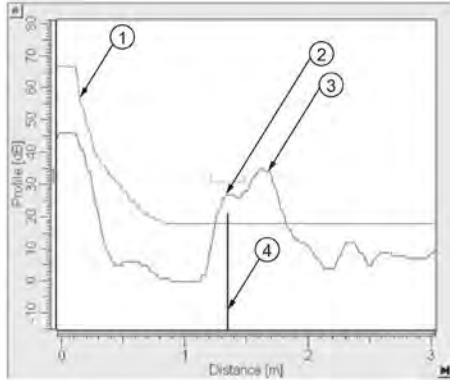

- ① default TVT
- ② material echo selected
- ③ vessel bottom echo
- ④ echo marker

A.3.3 CLEF RANGE (2.4.5.4.)

Determines the level below which the CLEF algorithm will be used. Above this level, the Center algorithm is used when Hybrid is selected in POSITION DETECT (2.4.5.2.) (Page 119). CLEF Range is referenced from FAR RANGE (2.4.2.) (Page 118).

A.3.4 ECHO THRESHOLD (2.4.5.3.)

CONFIDENCE (2.4.7.1.) (Page 122) describes the quality of an echo. Higher values represent higher quality. Echo Threshold defines the minimum confidence value required for an echo to be accepted as valid and evaluated.

A.3.5 ECHO LOCK (2.4.6.1.)

If the echo selected by ALGORITHM (2.4.5.1.) (Page 119) is within the Echo Lock window, the window is centered about the echo, which is used to derive the measurement. In radar applications, two measurement verification options are used:

Lock Off

SITRANS LR560 responds immediately to a new selected echo (within the restrictions set by the Maximum Fill / Empty Rate), but measurement reliability is affected.

Material Agitator

A new measurement outside the Echo Lock Window must meet the sampling criteria before the window will move to include it.

The other available options, **Maximum Verification** and **Total Lock** are not recommended for radar.

A.3.6 AUTO FALSE ECHO SUPPRESSION (2.4.8.1.)

Note

For detailed instructions on using this feature via the handheld programmer, see AUTO ECHO SUPPRESSION (2.4.8.1.) (Page 123).

Auto False Echo Suppression is designed to learn a specific environment (for example, a particular vessel with known obstructions), and in conjunction with Auto False Echo Suppression Range to remove false echoes appearing in front of the material echo.

The material level should be below all known obstructions at the moment when Auto False Echo Suppression learns the echo profile. Ideally the vessel should be empty or almost empty, and if an agitator is present, it should be running.

The device learns the echo profile over the whole measurement range and the TVT is shaped around all echoes present at that moment.

Auto False Echo Suppression Range

Auto False Echo Suppression Range specifies the range within which the learned TVT is applied. Default TVT is applied over the remainder of the range.

The learned TVT screens out the false echoes caused by obstructions. The default TVT allows the material echo to rise above it.

Auto False Echo Suppression Range must be set to a distance shorter than the distance to the material level when the environment was learned, to avoid the material echo being screened out.

Example before Auto False Echo Suppression

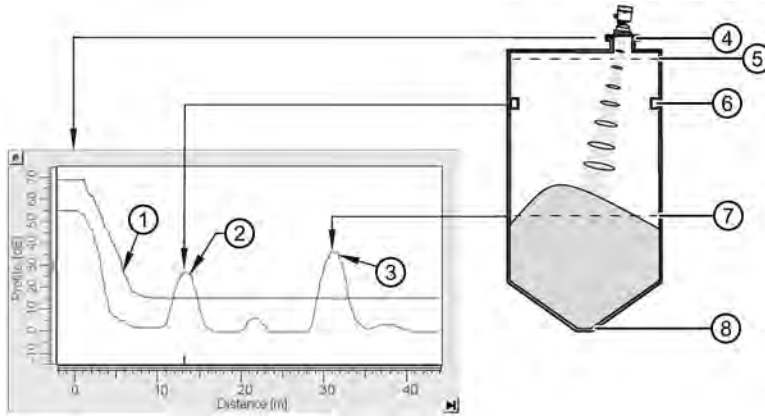

- ① default TVT
- ② false echo
- ③ material echo
- ④ sensor reference point
- ⑤ High Cal. Pt = 1 m
- ⑥ obstruction at 13 m
- ⑦ material level at 31 m
- ⑧ Low Cal. Pt. = 45 m

Example after Auto False Echo Suppression

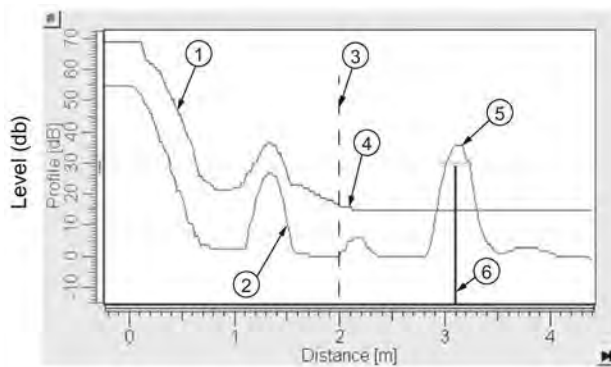

Auto False Echo
Suppression
Range set to 2 m

- | | |
|-------------------------------------|-----------------|
| ① Learned TVT | ④ Default TVT |
| ② False echo | ⑤ Material echo |
| ③ Auto False Echo Suppression Range | ⑥ Echo marker |

A.4 Measurement range

NEAR RANGE (2.4.1.) (Page 117)

Near Range programs SITRANS LR560 to ignore the zone in front of the antenna. The default blanking distance is 27.8 cm (0.91 ft) from the sensor reference point.

Near Range allows you to increase the blanking value from its factory default. But AUTO ECHO SUPPRESSION (2.4.8.1.) (Page 123) is generally recommended in preference to extending the blanking distance from factory values.

FAR RANGE (2.4.2.) (Page 118)

Far Range can be used in applications where the base of the vessel is conical or parabolic. A reliable echo may be available below the vessel empty distance, due to an indirect reflection path.

Increasing Far Range to 30% or 40% can provide stable empty vessel readings.

A.5 Measurement response

Note

Units are defined in **Quick Start Wizard (1.1.)** and are in meters by default.

RESPONSE RATE (2.3.6.1.) (Page 116) limits the maximum rate at which the display and output respond to changes in the measurement. There are three preset options: slow, medium, and fast.

Once the real process fill/empty rate (m/s by default) is established, a response rate can be selected that is slightly higher than the application rate. Response Rate automatically adjusts the filters that affect the output response rate.

RESPONSE RATE (2.3.6.1.) (Page 116)	FILL RATE/MIN (2.3.6.2.) (Page 116)/EMPTY RATE/MIN (2.3.6.3.) (Page 117)	FILTER TIME CONSTANT (2.5.7.1.) (Page 130)
Slow	0.1 m/min (0.32 ft/min)	600 s
Factory setting: Medium	1.0 m/min (3.28 ft.min)	60 s
Fast	10.0 m/min (32.8 ft/min)	0 s

A.6 Damping

FILTER TIME CONSTANT (2.5.7.1.) (Page 130) smooths out the response to a sudden change in level. This is an exponential filter and the engineering unit is always in seconds.

In 5 time constants the output rises exponentially: from 63.2% of the change in the first time constant, to almost 100% of the change by the end of the 5th time constant.

Damping example

time constant = 2 seconds

input (level) change = 2 m

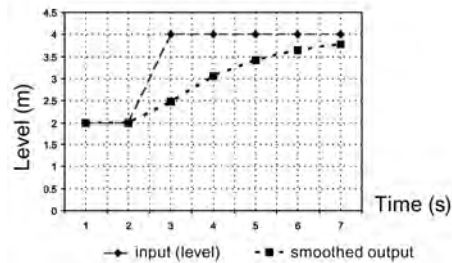

A.7 Loss of Echo (LOE)

A loss of echo (LOE) occurs when the calculated measurement is judged to be unreliable because the echo confidence value has dropped below the echo confidence threshold.

CONFIDENCE (2.4.7.1.) (Page 122) describes the quality of an echo. Higher values represent higher quality.

ECHO THRESHOLD (2.4.5.3.) (Page 120) defines the minimum confidence value required for an echo to be accepted as valid and evaluated.

If the LOE condition persists beyond the time limit set in LOE TIMER (2.3.4.) (Page 114) the LCD displays the Service Required icon, and the text region displays the fault code **S: 0** and the text LOE.

If two faults are present at the same time, the fault code, error text, and error icon for each fault are displayed alternately. For example, Loss of Echo and Fail-safe.

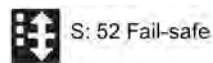

A.8 Temperature De-Rating

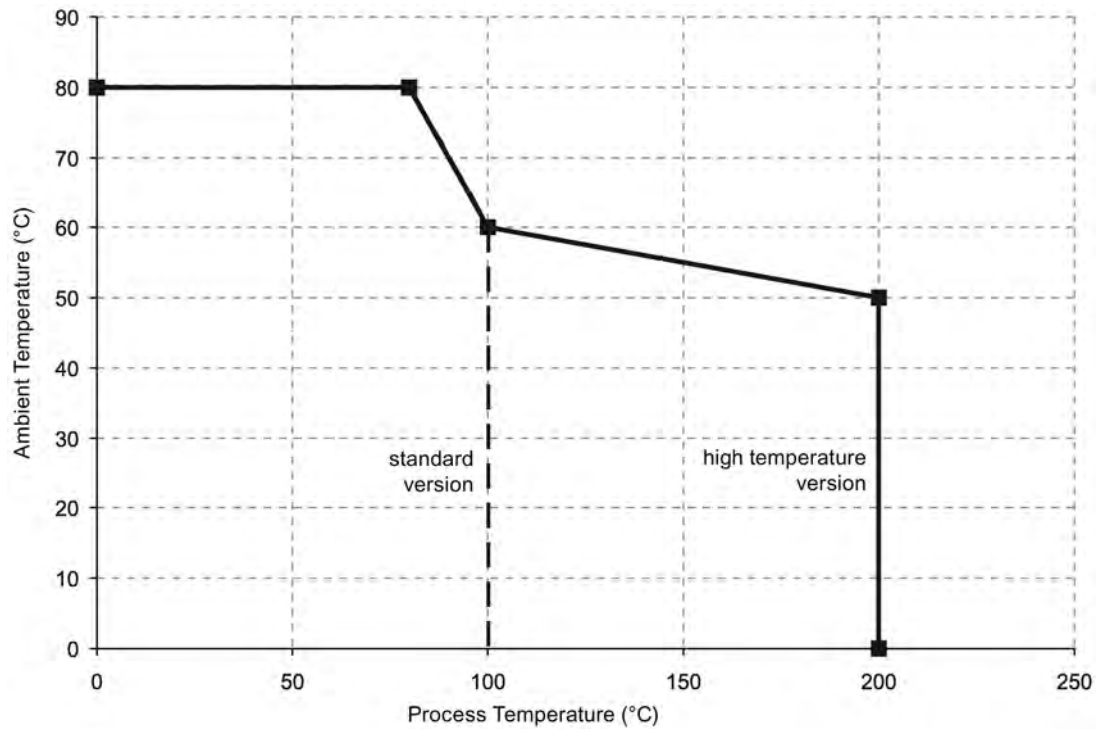

A.9 Temperature derating curve

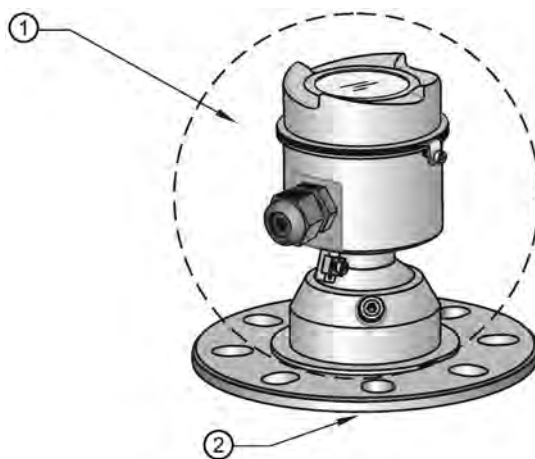

- ① ambient temperature
-40 °C to 80 °C
(-40 °F to 176 °F)
- ② process temperature:
-40 to +100 °C (-40 to +212 °F) or
-40 to +200 °C (-40 to +392 °F) depending on the version

Certificates and Support

B.1 Technical support

Technical support

If this documentation does not provide complete answers to any technical questions you may have, contact Technical Support at:

- Support request (<http://www.siemens.com/automation/support-request>)
- More information about our Technical Support is available at Technical Support (<http://www.siemens.com/automation/csi/service>)

Internet Service & Support

In addition to our documentation, Siemens provides a comprehensive support solution at:

- Services & Support (<http://www.siemens.com/automation/service&support>)

Personal contact

If you have additional questions about the device, please contact your Siemens personal contact at:

- Partner (<http://www.automation.siemens.com/partner>)

To find the personal contact for your product, go to "All Products and Branches" and select "Products & Services > Industrial Automation > Process Instrumentation".

Registered business address: Siemens AG, DE-76181, Karlsruhe, Germany

Documentation

You can find documentation on various products and systems at:

- Instructions and manuals (<http://www.siemens.com/processinstrumentation/documentation>)

B.2 QR code label

A QR code label can be found on the device. With the use of a smart phone, the QR code provides a direct link to a website with information specific to the device, such as manuals, FAQs, certificates, etc.

B.3 Certificates

You can find certificates on the Internet at LR560 (www.siemens.com/LR560) or on an included DVD.

HMI menu structure

C.1 HMI menu

1. QUICK START
 - 1.1. QUICK START WIZ.
 - VESSEL
 - RESPONSE RATE
 - UNITS
 - LOW CALIB. PT.
 - HIGH CALIB. PT.
 - 1.2. AFES WIZ.
 - AUTO SUPP RANGE
 - LEARN TVT
 - 1.3. CPY PAR TO DISPL.
 - 1.4. CPY PAR FROM DISPL.
 - 1.5. CPY FW TO DISPL.
 - 1.6. CPY FW FROM DIS.
2. SETUP
 - 2.1. IDENTIFICATION
 - 2.1.1. TAG
 - 2.1.2. DESCRIPTOR
 - 2.1.3. MESSAGE
 - 2.1.4. INSTAL. DATE
 - 2.2. DEVICE
 - 2.2.1. HARDWARE REV.
 - 2.2.2. FIRMWARE REV.
 - 2.2.3. LOADER REV
 - 2.2.4. MANUF. DATE
 - 2.3. SENSOR
 - 2.3.1. UNIT
 - 2.3.2. LEVEL UNIT
 - 2.3.3. TEMP. UNITS
 - 2.3.4. LOE TIMER
 - 2.3.5. CALIBRATION
 - 2.3.5.1. LOW CALIB. PT
 - 2.3.5.2. HI CALIB. PT.
 - 2.3.5.3. SENSOR OFFSET

- 2.3.5.4. LOW LEVEL PT.
- 2.3.5.5. HIGH LEVEL PT.
- 2.3.5.6. LEVEL OFFSET
- 2.3.6 RATE
 - 2.3.6.1. RESPONSE RATE
 - 2.3.6.2. FILL RATE/MIN
 - 2.3.6.3. EMPTY RATE/MIN
- 2.4 SIGNAL PROC.
 - 2.4.1. NEAR RANGE
 - 2.4.2. FAR RANGE
 - 2.4.3. MIN SENSOR VAL.
 - 2.4.4. MAX SENSOR VALUE
 - 2.4.5. ECHO SELECT
 - 2.4.5.1. ALGORITHM
 - 2.4.5.2. POS. DETECT
 - 2.4.5.3. ECHO THRESHOLD
 - 2.4.5.4. CLEF RANGE
 - 2.4.5.5. ECHO MARKER
 - 2.4.6. SAMPLING
 - 2.4.6.1. ECHO LOCK
 - 2.4.6.2. UP SAMP.
 - 2.4.6.3. DOWN SAMP.
 - 2.4.6.4. ECHO LOCK WINDOW
 - 2.4.7. ECHO QUALITY
 - 2.4.7.1. CONFIDENCE
 - 2.4.7.2. ECHO STRENGTH
 - 2.4.8. TVT SETUP
 - 2.4.8.1. AUTO ECHO SUPP.
 - 2.4.8.2. AUTO SUPP RANGE
 - 2.4.8.3. HOVER LEVEL
 - 2.4.8.4. SHAPER MODE
 - TVT SHAPER (2.4.9.)
 - 2.4.9.1. BRKPT. 1-9
 - 2.4.9.2. BRKPT. 10-18
 - 2.4.9.3. BRKPT. 19-27
 - 2.4.9.4. BRKPT. 28-36
 - 2.4.9.5. BRKPT. 37-45
 - 2.4.9.6. BRKPT. 46-54
 - 2.4.9.7. BRKPT. 55-63
 - 2.4.9.8. BRKPT. 64-72
 - 2.4.9.9. BRKPT. 73-81

- 2.4.9.10. BRKPT. 82-90
- 2.4.9.11. BRKPT. 91-99
- 2.4.9.12. BRKPT. 100-108
- 2.4.9.13. BRKPT. 109-117
- 2.4.9.14. BRKPT. 118-120

2.5. AIFB 1

- 2.5.1. STATIC REV. NO.
- 2.5.2. MODE
- 2.5.3. CHANNEL
- 2.5.4 INPUT SCALING
 - 2.5.4.1. LOWER VALUE
 - 2.5.4.2. UPPER VALUE
 - 2.5.4.3. UNIT
 - 2.5.4.4. DECIMAL POINT
- 2.5.5. OUTPUT SCALING
 - 2.5.5.1. LOWER VALUE
 - 2.5.5.2. UPPER VALUE
 - 2.5.5.3. UNIT
 - 2.5.5.4. DECIMAL POINT
- 2.5.6. ALARMS & WARNI.
 - 2.5.6.1. HI LIMIT ALARM
 - 2.5.6.2. HI LIMIT WARN
 - 2.5.6.3. LO LIMIT WARN
 - 2.5.6.4. LO LIMIT ALARM
 - 2.5.6.5. LIMIT HYSTERESI..
- 2.5.7. DISPLAY
 - 2.5.7.1. FILTER TIME CONS..

2.6. AIFB 2

- 2.6.1. STATIC REV. NO.
- 2.6.2. MODE
- 2.6.3. CHANNEL
- 2.6.4. INPUT SCALING
 - 2.6.4.1. LOWER VALUE
 - 2.6.4.2. UPPER VALUE
 - 2.6.4.3. UNIT
 - 2.6.4.4. DECIMAL POINT
- 2.6.5. OUTPUT SCALING
 - 2.6.5.1. LOWER VALUE
 - 2.6.5.2. UPPER VALUE
 - 2.6.5.3. UNIT
 - 2.6.5.4. DECIMAL POINT

- 2.6.6. ALARMS & WARNI..
 - 2.6.6.1. HI LIMIT ALARM
 - 2.6.6.2. HI LIMIT WARN
 - 2.6.6.3. LO LIMIT WARN
 - 2.6.6.4. LO LIMIT ALARM
 - 2.6.6.5. LIMIT HYSTERESI..
- 2.6.7. DISPLAY
 - 2.6.7.1. FILTER TIME CONS..
- 2.7. MEAS. VALUES
 - 2.7.1. MAIN OUTPUT
 - 2.7.2. O/P NO LINEAR
 - 2.7.3. O/P NO OFFSETS
- 2.8. FILTERING
 - 2.8.1. NARROW ECHO FIL..
 - 2.8.2. REFORM ECHO
 - 2.8.3. AVG AMOUNT
- 3. DIAGNOSTICS
 - 3.1. ECHO PROFILE
 - 3.2. FAULT RESET
 - 3.3. TREND
 - 3.4. ELECT. TEMP.
 - 3.4.1. MIN. VALUE
 - 3.4.2. MAX. VALUE
 - 3.5. PEAK VALUES
 - 3.5.1. MIN MEAS. VALUE
 - 3.5.2. MAX MEAS. VALUE
- 4. SERVICE
 - 4.1. MASTER RESET
 - 4.2. REMAIN. DEV. LIFE
 - 4.2.1. LIFETIME EXPECT..
 - 4.2.2. TIME IN OPER.
 - 4.2.3. REMAIN. LIFETIM..
 - 4.2.4. REMINDER ACTIV.
 - 4.2.5. REMIND. 1 (REQ.)
 - 4.2.6. REMIND. 2 (DEM.).
 - 4.2.7. MAINT STAT
 - 4.2.8. ACK STATUS
 - 4.2.9. ACK
 - 4.3. REMAIN SENS LIFE
 - 4.3.1. LIFETIME EXPECT..
 - 4.3.2. TIME IN OPER.

- 4.3.3. REMAIN. LIFETIM..
 - 4.3.4. REMINDER ACTIV.
 - 4.3.5. REMIND. 1 (REQ.)
 - 4.3.6. REMIND. 2 (DEM.).
 - 4.3.7. MAINT STAT
 - 4.3.8. ACK STATUS
 - 4.3.9. ACK
 - 4.4. SERVICE SCHED.
 - 4.4.1. SERV. INTERVAL
 - 4.4.2. TIME LAST SERV
 - 4.4.3. TIME NEXT SERVI..
 - 4.4.4. REMINDER ACTIV.
 - 4.4.5. REMIND. 1 (REQ.)
 - 4.4.6. REMIND. 2 (DEM.)
 - 4.4.7. MAINT STAT
 - 4.4.8. ACK STATUS
 - 4.4.9. ACK
 - 4.5. CALIB. SCHED.
 - 4.5.1. CALIB. INTERVAL
 - 4.5.2. TIME LAST CALIB
 - 4.5.3. TIME NEXT CALIB
 - 4.5.4. REMINDER ACTIV.
 - 4.5.5. REMIND. 1 (REQ.)
 - 4.5.6. REMIND. 2 (DEM.)
 - 4.5.7. MAINT STAT
 - 4.5.8. ACK STATUS
 - 4.5.9. ACK
 - 4.6. POWERED HOURS
 - 4.7. POWERON RESETS
 - 4.8. MENU TIMEOUT
 - 4.9. LCD BACKLIGHT
 - 4.10. LCD CONTRAST
 - 4.11. SECONDARY VALUE
 - 4.12. SIMULATE ENABLE
 - 4.13. DEMO MODE
 - 4.14. STORED SW VER
5. COMMUNICATION
- 5.1. TAG
 - 5.2. DEVICE ADDRESS
 - 5.3. MANUFACTURER
 - 5.4. DEVICE TYPE ID

- 5.5. DEVICE REVISION
- 5.6. ITK VERSION
- 6. SECURITY
 - 6.1. REMOTE ACCESS
 - 6.1.1. REMOTE LOCKOUT
 - 6.2. LOCAL ACCESS
 - 6.2.1. WRITE PROTECTION
 - 6.2.2. LOCAL OPERATION
- 7. LANGUAGE

D

List of abbreviations

D.1 List of abbreviations

Short form	Long form	Description	Units
CE / FM / CSA	Conformité Européenne / Factory Mutual / Canadian Standards Association	safety approval	
DCS	Distributed Control System	control room apparatus	
dK	dielectric constant		
EDD	Electronic Device Description		
ESD	Electrostatic Discharge		
FMCW	Frequency Modulated Continuous Wave	radar principle	
HART	Highway Addressable Remote Transducer		
HMI	Human Machine Interface		
I_i	Input current		mA
I_o	Output current		mA
IS	Intrinsically Safe	safety approval	
LCD	Liquid Crystal Display		
μ s	microsecond	10^{-6}	s
PA	Process Automation (PROFIBUS)		
PED	Pressure Equipment Directive	safety approval	
ppm	parts per million		
PV	Primary Variable	measured value	
SELV	Safety extra low voltage		
SV	Secondary Value	equivalent value	
TB	Transducer Block		
TVT	Time Varying Threshold	sensitivity threshold	
U_i	Input voltage		V
U_o	Output voltage		V

Glossary

accuracy

degree of conformity of a measure to a standard or a true value.

algorithm

a prescribed set of well-defined rules or processes for the solution of a problem in a finite number of steps.

ambient temperature

the temperature of the surrounding air that comes in contact with the enclosure of the device.

antenna

an aerial which sends out and receives a signal in a specific direction. There are four basic types of antenna in radar level measurement, horn, parabolic, rod, and waveguide.

Auto False-Echo Suppression

a technique used to adjust the level of a TVT to avoid the reading of false echoes. (See TVT.)

Auto-False Echo Suppression Range

defines the endpoint of the learned TVT distance. This is used in conjunction with auto false echo suppression.

beam angle

the angle diametrically subtended by the on-half power limits (-3 dB) of the microwave beam.

beam spreading

the divergence of a beam as it travels through a medium.

blinking

a blind zone extending away from the reference point plus any additional shield length. The device is programmed to ignore this zone.

capacitance

the property of a system of conductors and dielectrics that permits the storage of electricity when potential differences exist between the conductors. Its value is expressed as the ratio of a quantity of electricity to a potential difference, and the unit is a Farad.

confidence

see Echo Confidence.

damping

term applied to the performance of a device to denote the manner in which the measurement settles to its steady indication after a change in the value of the level.

dB (decibel)

a unit used to measure the amplitude of signals.

derating

to decrease a rating suitable for normal conditions according to guidelines specified for different conditions.

dielectric

a nonconductor of direct electric current. Many conductive liquids/electrolytes exhibit dielectric properties; the relative dielectric constant of water is 80.

dielectric constant (dK)

the ability of a dielectric to store electrical potential energy under the influence of an electric field. Also known as Relative Permittivity. An increase in the dielectric constant is directly proportional to an increase in signal amplitude. The value is usually given relative to a vacuum /dry air: the dielectric constant of air is 1.

echo

a signal that has been reflected with sufficient magnitude and delay to be perceived in some manner as a signal distinct from that directly transmitted. Echoes are frequently measured in decibels relative to the directly transmitted signal.

Echo Confidence

describes the quality of an echo. Higher values represent higher quality. Echo Threshold defines the minimum value required for an echo to be accepted as valid and evaluated.

Echo Lock Window

a window centered on an echo in order to locate and display the echo's position and true reading. Echoes outside the window are not immediately processed.

Echo Marker

a marker that points to the processed echo.

Echo Processing

the process by which the radar unit determines echoes.

Echo Profile

a graphical display of a processed echo.

Echo Strength

describes the strength of the selected echo in dB referred to 1 μ V rms.

false echo

any echo which is not the echo from the desired target. Generally, false echoes are created by vessel obstructions.

frequency

the number of periods occurring per unit time. Frequency may be stated in cycles per second.

HART

Highway **A**ddressable **R**emote **T**ransducer. An open communication protocol used to address field instruments.

Hertz (Hz):

unit of frequency, one cycle per second. 1 Gigahertz (GHz) is equal to 10^9 Hz.

inductance

the property of an electric circuit by virtue of which a varying current induces an electromotive force in that circuit or in a neighboring circuit. The unit is a Henry.

local display interface (LDI)

the removable LCD display with push buttons

microwaves

the term for the electromagnetic frequencies occupying the portion of the radio frequency spectrum from 1 GHz to 300 GHz.

Near Blanking

see Blanking.

nozzle

a length of pipe mounted onto a vessel that supports the flange.

parameters

in programming, variables that are given constant values for specific purposes or processes.

polarization

the property of a radiated electromagnetic wave describing the time-varying direction and amplitude of the electric field vector.

polarization error

the error arising from the transmission or reception of an electromagnetic wave having a polarization other than that intended for the system.

pulse radar

a radar type that directly measures distance using short microwave pulses. Distance is determined by the return transit time.

radar

radar is an acronym for **RA**dio **D**etection **A**nd **R**anging. A device that radiates electromagnetic waves and utilizes the reflection of such waves from distant objects to determine their existence or position.

range

distance between a transmitter and a target.

range extension

the distance below the zero percent or empty point in a vessel.

repeatability

the closeness of agreement among repeated measurements of the same variable under the same conditions.

shot

one transmit pulse or measurement.

TVT (Time Varying Threshold)

a time-varying curve that determines the threshold level above which echoes are determined to be valid.

Index

A

- Abbreviations and identifications list, 190
- Activating, 38
- Approvals
 - hazardous area, 163
 - radio, 163
- Auto False Echo Suppression
 - setup, 123

B

- Blanking (see Near Range), 179

C

- calibration schedule
 - maintenance, 141
- Calibration Schedule, 141
- Certificates, 13, 183
- Cleaning, 149
- CLEF (Constrained Leading Edge Fit)
 - explanation, 175
- Compact Operating Instructions, 182
- configuration
 - Quick Start via local display, 48
- Customer Support, (Refer to Technical support)

D

- Damping
 - explanation, 180
- Device Address
 - setting via LUI, 53
- Device Reset, 134
 - factory defaults, 134
- Device Status
 - icons, 154
- Diagnostics, 132
- Disassembly, 27
- Disposal, 153
- Documentation, 182

E

- echo processing
 - Process Intelligence, 173
- Echo Profile
 - view via loca display, 52
- echo selection
 - Algorithm, 175
 - CLEF (Constrained Leading Edge Fit), 175
 - Position algorithm, 175
- Echo selection
 - time varying threshold (TVT), 174

F

- factory defaults, 134
- Far Range
 - explanation, 179
- fault codes
 - general fault codes, 155

H

- Hazardous area
 - Laws and directives, 13
 - Qualified personnel, 16
- Hotline, (Refer to Support request)

I

- Identifications and abbreviations
 - list, 190
- Instructions and manuals, 182

L

- Language, 147
- Laws and directives
 - Disassembly, 13
 - Personell, 13
- LCD display
 - echo profile viewing, 52
- Lithium batteries
 - Return, 152
 - Safety, 42

loss of echo (LOE)
 explanation, 180

M

maintenance
 service schedule, 139
 Maintenance, 148
 maintenance settings, 135
 Manuals, 182
 Master Reset
 factory defaults via LUI, 134
 measurement range
 blanking via Near Range, 179
 extension via Far Range, 179
 Measurement Response
 explanation, 179
 Modifications
 correct usage, 13
 improper, 13
 Mounting
 beam angle, 23
 nozzle location, 23

N

Near Range
 explanation, 179
 Nozzle location
 Shaper Mode, 23

O

Operating Instructions, 182
 operating principles, 173
 Overview, 18

P

password protection
 via AMS, 95
 power source
 requirements, 29
 Process Intelligence, 173
 programmer
 handheld, 41
 programming
 via the handheld programmer, 44

Q

QR code label, 182
 Qualified personnel, 16
 Quick Start Wizard
 via local display, 48

R

Reading erratic
 troubleshooting, 158
 Reading incorrect
 troubleshooting, 159
 Reading response slow, 158
 resets
 Device Reset, 134
 Response Rate
 explanation, 179
 Return procedure, 152

S

Scan Device
 synchronize parameters via AMS, 57
 Scope of delivery, 11
 security
 enable/disable remote operation remote access
 control, 146
 local access control via AMS, 87
 password protection via AMS, 95
 password protection via AMS via AMS, 95
 Service, 182
 Service & Support, 182
 Internet, 182
 Service Schedule, 139
 Simulation
 input, 67
 SITRANS LR560
 FMCW, 173
 operating principles, 173
 startup
 transition screen, 38
 Support, 182
 Support request, 182
 synchronize parameters
 scan device via AMS, 57

T

Technical data, 160
 air purge connection, 161

- ambient temperature, 161
- enclosure, 161
- environmental, 161
- lens antenna material, 161
- process connections, 161
- process temperature, 162, 162
- weight, 161
- Technical support, 182
 - Partner, 182
 - Personal contact, 182
- Test certificates, 13
- Troubleshooting
 - operation, 158
- TVT (time varying threshold)
 - explanation, 174

W

- Warranty, 11
- Wear
 - Powered Hours, Power-on Resets, 143