

# Instruction manual

Leak detector with camera

**ILD 500 / ILD 510**



---

<b>1</b>	<b>Table of Content</b>	
<b>2</b>	<b>SAFETY INSTRUCTIONS</b>	<b>5</b>
2.1	GENERAL SAFETY INSTRUCTION	5
2.2	USING OF CLASS 2 LASER	5
<b>3</b>	<b>SERVICE AND MAINTENANCE</b>	<b>6</b>
<b>4</b>	<b>ENVIRONMENTAL PROTECTION</b>	<b>6</b>
<b>5</b>	<b>INTENDED USE</b>	<b>6</b>
<b>6</b>	<b>TECHNICAL DATA ILD50</b>	<b>7</b>
<b>7</b>	<b>IDENTIFICATION</b>	<b>8</b>
7.1	NAME PLATE	8
7.2	LASER WARNING LABEL	8
7.3	LABEL POSITIONS	8
7.3.1	<i>ILD500 / ILD510 (For Standard &amp; Laser distance module)</i>	8
7.3.2	<i>Parabolic mirror</i>	8
<b>8</b>	<b>DEVICE COMPONENTS AND CONTROLS</b>	<b>9</b>
8.1	THE ILD 500	9
<b>9</b>	<b>OVERVIEW AND APPLICATION DESCRIPTION OF THE DIFFERENT SENSOR TYPES</b>	<b>10</b>
9.1	ASSEMBLY WITH ACOUSTIC TRUMPET	11
9.2	ASSEMBLY WITH FOCUS TUBE WITH FOCUS TIP	11
9.3	ASSEMBLY WITH GOSENECK	12
9.4	ASSEMBLY WITH PARABOLIC MIRROR	12
<b>10</b>	<b>START-UP // APPLICATION ILD 500</b>	<b>13</b>
10.1	SWITCH ON	13
10.2	HEADPHONE VOLUME UP / VOLUME DOWN	13
10.3	SENSITIVITY LEVEL	13
10.4	LASER ON/OFF	13

---

<b>11</b>	<b>OPERATION .....</b>	<b>14</b>
11.1	INITIALIZATION .....	14
11.2	SCREEN LECKAGE .....	15
11.3	HOME MENU ILD 500.....	16
11.3.1	<i>Configuration of ILD500</i> .....	17
11.3.1.1	Sensortype selection (Measuring tool).....	18
11.3.1.2	Storing of the measurement.....	19
11.3.1.3	Parameter / Meas. Point (Re-Check) .....	19
11.3.1.4	Fault description .....	20
11.3.1.5	Storing measurement data to internal SD-card.....	20
11.3.2	<i>Export/Import</i> .....	21
11.3.2.1	Export .....	22
11.3.2.1.1	Export „Leakage Data“ .....	22
11.3.2.1.2	Export of System settings .....	23
11.3.2.2	Import.....	24
11.3.2.2.1	Import of system settings.....	24
11.3.2.2.2	Import new measurement tool .....	25
11.3.2.3	Export / Import Customer database.....	26
11.3.3	<i>View bitmaps</i> .....	27
11.3.4	<i>Device Settings</i> .....	28
11.3.4.1	Passwort-Einstellung .....	28
11.3.4.2	Device Settings .....	29
11.3.4.2.1	Language .....	29
11.3.4.2.2	Date & Time.....	30
11.3.4.2.3	SD-Card.....	30
11.3.4.2.4	System update.....	31
11.3.4.2.5	Check for Updates .....	31
11.3.4.2.6	Update Channels .....	32
11.3.4.2.7	Factory Reset.....	32
11.3.4.2.7.1	Reset to default settings.....	32
11.3.4.2.8	Unique USB ID .....	32
11.3.4.2.9	Calibration of touchpanel .....	33
11.3.4.2.10	Set backlight brightness.....	34
11.3.4.2.11	Cleaning .....	35
11.3.4.2.12	System-Status .....	35
11.3.4.2.13	About ILD 500 .....	35
<b>12</b>	<b>CHARGING THE BATTERIES .....</b>	<b>36</b>

<b>13</b>	<b>ILD 510</b>	<b>37</b>
13.1	SELECTION EXTERNAL SENSOR	37
13.2	INPUT SIGNALS OF EXT. SENSOR ILD510	38
13.3	CABLE CROSS SECTION	38
13.3.1	<i>Sensor circuit points/Output signal:</i>	38
13.4	CONNECTION DIAGRAMS FOR DIFFERENT SENSOR TYPES	39
13.4.1	<i>Connector pin assignment for all sensors at PI 500</i>	39
13.4.2	<i>Connection for dew point- and consumption sensors, series FA/VA 5xx</i>	40
13.4.3	<i>Connection with RS485</i>	40
13.4.4	<i>Three- and four-wire power supply 0 - 1/10/30 VDC</i>	40
13.4.5	<i>Analogue two-, three-, and four-wire current signal</i>	41
13.4.6	<i>Two-, three- and four-wire connector pin assignments for PT100/PT1000/KTY81</i>	42
13.5	DEW POINT SENSOR FA 500 / FA 510 (RS 485 MODBUS)	43
13.5.1	<i>Settings Dew point sensor FA 500 / FA 510</i>	44
13.5.1.1	Unit selection for temperature and humidity	44
13.5.1.2	Definition of the System pressure (relative pressure value)	44
13.5.1.3	Definition of Reference pressure (absolute pressure value)	45
13.5.1.4	Field adjustment	45
13.5.1.5	More Settings Analogue output 4-20mA	46
13.6	FLOW SENSOR OF TYPE VA 500 / VA 520 / VA 550 / VA 570 (RS 485 MODBUS)	47
13.6.1	<i>Settings for Flow sensor VA 5xx</i>	48
13.6.1.1	Diameter settings (only for VA 500 or VA 550)	48
13.6.1.2	Gas Constant settings	49
13.6.1.3	Definition of the reference conditions	50
13.6.1.4	Definition Unit of flow and velocity	50
13.6.1.5	Definition consumption counter value and consumption unit	51
13.6.1.6	Settings analogue output 4-20mA of VA 5xx	52
13.6.1.7	Settings Pulse / Alarm output of VA 5xx	53
13.6.1.8	Settings ZeroPoint or Low Flow Cut off for VA 5xx	55
13.7	TYPE MODBUS	56
13.7.1	<i>Selection and activation of Sensor-Type Modbus</i>	56
13.7.1.1	Modbus Settings	56
13.8	DATA LOGGER SETTINGS	60
<b>14</b>	<b>SCOPE OF DELIVERY</b>	<b>64</b>
<b>15</b>	<b>APPENDIX</b>	<b>64</b>

## 2 Safety instructions



### About this document

- Read this documentation carefully and familiarize yourself with the product before using it. Pay particular attention to the safety and warning instructions to prevent injury and product damage.
- Keep this documentation handy for future reference.
- Share this documentation with future users of the product.

### 2.1 General safety instruction

	<ul style="list-style-type: none"> <li>• The product is to be used only in accordance with the intended purpose and within the parameters specified in the technical data. Do not use force for operation.</li> <li>• Never measure with the device at or near live/energized parts!</li> <li>• During leak detection on electrical systems, please maintain a sufficient safety distance to avoid dangerous electric shocks!</li> <li>• Avoid any direct contact with hot and/or rotating parts.</li> <li>• Always switch on the device before putting on the headphones! At high signal levels (bar graph headphones in the red area), the volume can be correspondingly large. The sensitivity setting can be used to reduce the volume.</li> <li>• Observe the prescribed storage and operating temperatures.</li> <li>• In case of improper handling or violence, the warranty claims are lost.</li> <li>• Interventions on the device of any kind, unless they correspond to the intended and described procedures, lead to the expiration of warranty and to the disclaimer.</li> <li>• The device is intended solely for the described purpose.</li> </ul>
---	--

### 2.2 Using of class 2 laser

	<ul style="list-style-type: none"> <li>• Never point the laser directly towards persons!</li> <li>• Absolutely avoid a direct irradiation of the eyes of humans and animals!</li> <li>• If a person's eyes are exposed to class 2 laser radiation, they should shut their eyes and immediately move away from the beam</li> <li>• Do not stare into the beam</li> <li>• Laser module: corresponds to DIN EN 60825-1: 2014 Class 2 (&lt;math&gt;&lt;1\text{mW}&lt;/math&gt; / 635nm)</li> <li>• Laser output point trumpet and parabolic mirror:</li> </ul>
	 <div style="display: flex; justify-content: space-around; margin-top: 10px;"> <div style="border: 1px solid black; padding: 5px; text-align: center;"> <b>Laseraustrittsstelle Laser output point</b> </div> <div style="border: 1px solid black; padding: 5px; text-align: center;"> <b>Laseraustrittsstelle Laser output point</b> </div> </div>

### 3 Service and maintenance

Service and maintenance work must only be carried out by authorized personnel.

### 4 Environmental protection



- Disposal of defective batteries / dead batteries according to the valid legal regulations.
- After the end of the useful life, take the product to the separate collection for electrical and electronic equipment (observe local regulations)

ICS makes no warranty as to its suitability for any particular purpose and assumes no liability for any errors contained in this manual. Nor for consequential damages in connection with the delivery, performance or use of this device.

### 5 Intended use

The ILD 500 is a leak detector for quick and reliable leak detection in/on compressed air systems.

The ILD500 leak detector evaluates the ultrasonic waves generated by the leakage based on distance and pressure.

It is solely designed and constructed for the intended use described here and may only be used for this purpose.

The user must verify that the device is suitable for the intended use. The technical data listed in this datasheet are binding.

Improper handling or operation outside the technical specifications is not permitted. Claims of any kind for damages arising from improper use are excluded.

## 6 Technical data ILD50

Dimensions hand-held housing	263 x 96 x 280 mm (with preamp module and acoustic trumpet)
Weight	0.55 kg with preamp module and acoustic trumpet, complete set in case approx. 3.0 kg
Operating frequency	40 kHz (+/-2 kHz)
Power supply	Internal 7.4 V lithium-ion battery
Operating time	> 9 h (continuous operation)
Charging	ext. battery charger (included in scope of delivery)
Charging time	max.4 h
Laser	Wavelength 630–660nm, output power < 1mW (laser class 2)
Connections	3.5 mm stereo jack for headset, Power supply socket for connecting an external charger USB connection
Colour screen	3.5" touch panel TFT transmissive
Interface	USB for data export/import, SW update, etc.
Data logger	8 GB memory card storage (micro SD class 4)
Application Area	Indoor use
Operating temperaturer	-5 °C bis +50 °C
Storage temperature	-20 °C to +60 °C
Altitude	Up to 4000m above sea level
Max. Humidity	<95% rH, without condensation
Pollution degree	2
Protection class	IP20

## 7 Identification

### 7.1 Name plate



### 7.2 Laser warning label

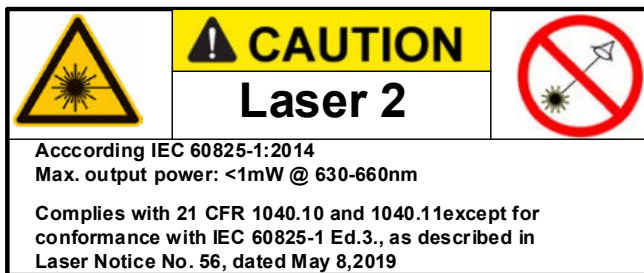

### 7.3 Label positions

#### 7.3.1 ILD500 / ILD510 (For Standard & Laser distance



#### 7.3.2 Parabolic mirror





## 8 Device components and controls





### 8.1 The ILD 500



3.5mm jack for the headphone



## 9 Overview and application description of the different sensor types

<p><b>Acoustic trumpet (standard tool)</b></p>  <p>The acoustic trumpet bundles incident ultrasonic waves, thereby extending the range of the device. This behaviour makes it ideal for medium distances. The leakage can be heard from large distances, for precise detection, the user must approach the leakage and consistently follow the "loudest" point. Individual compressed air components are then checked for precise detection. Quantification distance (distance) □ 1 – 6 m</p> <p><b>Use of acoustic trumpet:</b></p> <ul style="list-style-type: none"> <li>• Average distance to pipe/component 0.2 - 6 m</li> <li>• Low interfering noise</li> <li>• Leakage freely accessible</li> <li>• Use at distances of up to 6 metres if no parabolic mirror available</li> </ul>	<p><b>Straightening tube</b></p>  <p>The straightening tube permits only very few ultrasonic waves to pass in the direction of the ultrasonic transducer, allowing leakages to be located very precisely.</p> <p>For this reason, the use of the straightening tube is recommended for small distances, for the precise detection of the corresponding leakage.</p> <p><b>Quantification distance:</b> 0...0,2 m</p> <p><b>Use of focus tube:</b></p> <ul style="list-style-type: none"> <li>• Short distance to pipe/component 0.05 m</li> <li>• Pipe/component freely accessible</li> <li>• Pipes and components to be inspected are very close together</li> <li>• Medium to high noise</li> <li>• Use when no gooseneck available</li> </ul>
<p><b>Gooseneck</b></p>  <p>The gooseneck should be used if the pipes and components to be inspected are physically very close. In addition, the shape of the gooseneck can be flexibly adapted to easily inspect hard-to-reach pipes and components.</p> <p>The sensitivity of the gooseneck has been reduced to dampen noise. This makes it ideal for target-ed, local testing of compressed air components at high noise levels, for example in systems using pneumatic cylinders and in compressed air distribution cabinets</p> <p><b>Quantification distance</b> → 0 ...0.05m</p> <p><b>Use of gooseneck:</b></p> <ul style="list-style-type: none"> <li>• Short distance to pipe/component 0.05 m</li> <li>• Leakage not freely accessible</li> <li>• Medium to high ultrasonic noise</li> <li>• Pipes and components to be inspected are very close together</li> </ul>	<p><b>Parabolic mirror</b></p>  <p>The parabolic mirror bundles horizontally incident ultrasound in its focal point where the ultrasonic transducer is located. On the one hand, this leads to a considerable amplification of the measured ultrasound (high range) and, on the other hand, to a very precise directional behaviour, since ultra-sound that does not incident horizontally is reflected by the reflector.</p> <p>The combination of these two characteristics enables the parabolic mirror to precisely locate leaks at large distances.</p> <p><b>Quantification distance</b> → 3 – 12 m</p> <p><b>Use of parabolic mirror:</b></p> <ul style="list-style-type: none"> <li>• Large distance to pipe/components 3 – 15 m</li> <li>• Interfering noise</li> <li>• Leakage not freely accessible (behind a fence)</li> <li>• Near leaks (superimposition))</li> </ul>

### 9.1 *Assembly with acoustic trumpet*

The acoustic trumpet allows acoustic amplification by bundling the sound waves and specifies the location of the leak. Due to the special construction of the integrated laser pointer is still usable. The camera is integrated on the bottom of the acoustic trumpet and is electrically connected to the preamplifier module via the jack plug.

Assembling is done by plugging the individual components until easy locking audible (plug in to the stop).

The components are removed in the reverse order; for unlocking the preamplifier module, the release button must also be pressed.



### 9.2 *Assembly with focus tube with focus tip*

The focus tube with focus tip is used to detect very small leaks, to accurately locate them.

Just like the acoustic trumpet, the tube can be plugged into the preamplifier with ultrasonic receiver. The use of the camera is **no longer** possible.

The components are removed in the reverse order; for unlocking the preamplifier module, the release button must also be pressed.



### 9.3 Assembly with Gooseneck

Due to its flexibility, the gooseneck tool is used for punctual measurements in hard-to-reach areas. Connection to the ILD 500 is via the supplied spiral cable, see Figure 10.

It is **no longer** possible to use the camera.

To remove the component, remove the connection cable by pressing the release button on both sides and pulling off the cable.



### 9.4 Assembly with Parabolic mirror

The parabolic mirror is used for measurements at greater distances as well as for high requirements regarding selectivity and location of leakage positions.

Connection to the ILD 500 is via the supplied spiral cable, see Figure 11.

To remove the component, remove the connection cable by pressing the release button on both sides and pulling off the cable.



**Note:** To use the parabolic mirror and gooseneck, these components must be activated in the ILD 500 during initial commissioning in order to save the component-specific adjustment parameters. If this has not already been done ex-works, the data for this is supplied via USB stick. For the activation (parameter import), see chapter 11 Operation here in Sub chapter "Export / Import".

## 10 Start-up / / Application ILD 500



Please first observe the safety instructions in Chapter 2

### 10.1 Switch on

Hold down the power button for about 1 second, the power will turn on, and a start-up sequence will appear on the display. Pressing the button again switches the device off again.

On-Off button, see [device components and controls](#)

### 10.2 Headphone Volume Up / Volume Down

The volume up and volume down buttons in the headset can be increased or decreased in 16 steps. Continuously pressing the button automatically increases / decreases the value.

Volume up / down buttons for headphone volume, see [device components and controls](#)



Please make sure the headphone level is <50% before putting on the headphones.

### 10.3 Sensitivity level

Ultrasound levels can be understood as a "loudness" of the leakage.

With the "Sensitivity" button, the sensitivity of the ILD500 can be adjusted to the environment, which strongly influences the acoustic behaviour of the device and increases or decreases the valid value range. A reduction in sensitivity reduces the range of the leakage reading but the "responding area", indicated by the circle in the display, also gets smaller, which considerably simplifies detection.

#### Sensitivity levels

**0 – 60 dB** = Highest sensitivity level of the device (use with small leaks and no noise), selection with the "HiSn" button or the "Sensitivity" button

**10 – 70 dB** = Leakages and noises get "less noisy", the range is reduced.

**20 – 80 dB** = Leakages and noises get "less noisy", the range is reduced.

**30 – 90 dB** = Leakages and noises get "less noisy", the range is reduced.

**40 – 100 dB** = Most insensitive stage (large leaks, many noises → for heavy-duty application)

By default, the ILD500 is set to the auto function and will automatically switch between levels (10 – 70 dB to 40 – 100 dB).

### 10.4 Laser On/Off

The laser pointer can only be switched on or off via the laser on / off button  in the display (not via the membrane keypad). When switched on, the display shows a laser warning symbol.

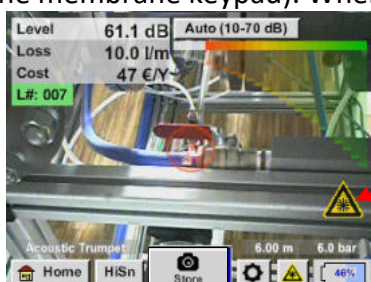

Laser „On“  
Icon



**Please note the warnings for laser operation!**  
**Avoid direct / indirect (via reflexion) irradiation of the eyes in humans and animals!**

## 11 Operation

The operation is largely self-explanatory and menu-driven via the touch panel.

The selection of the respective menu items occur via short "tapping" with the finger or a soft round pen.

**Attention: Please use no pens or other objects with sharp edges!**  
**The foil can be damaged!**

Inputs or changes can be made with all white deposit fields

### 11.1 Initialization

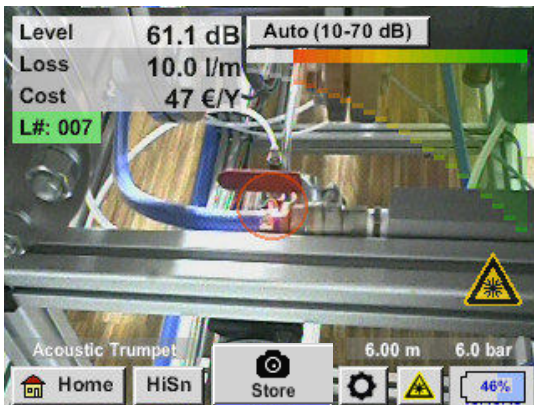

After switching on the ILD 500, the initialization takes place and then switch to leakage display

### 11.2 Screen Leakage

The following picture shows and describes the display elements.

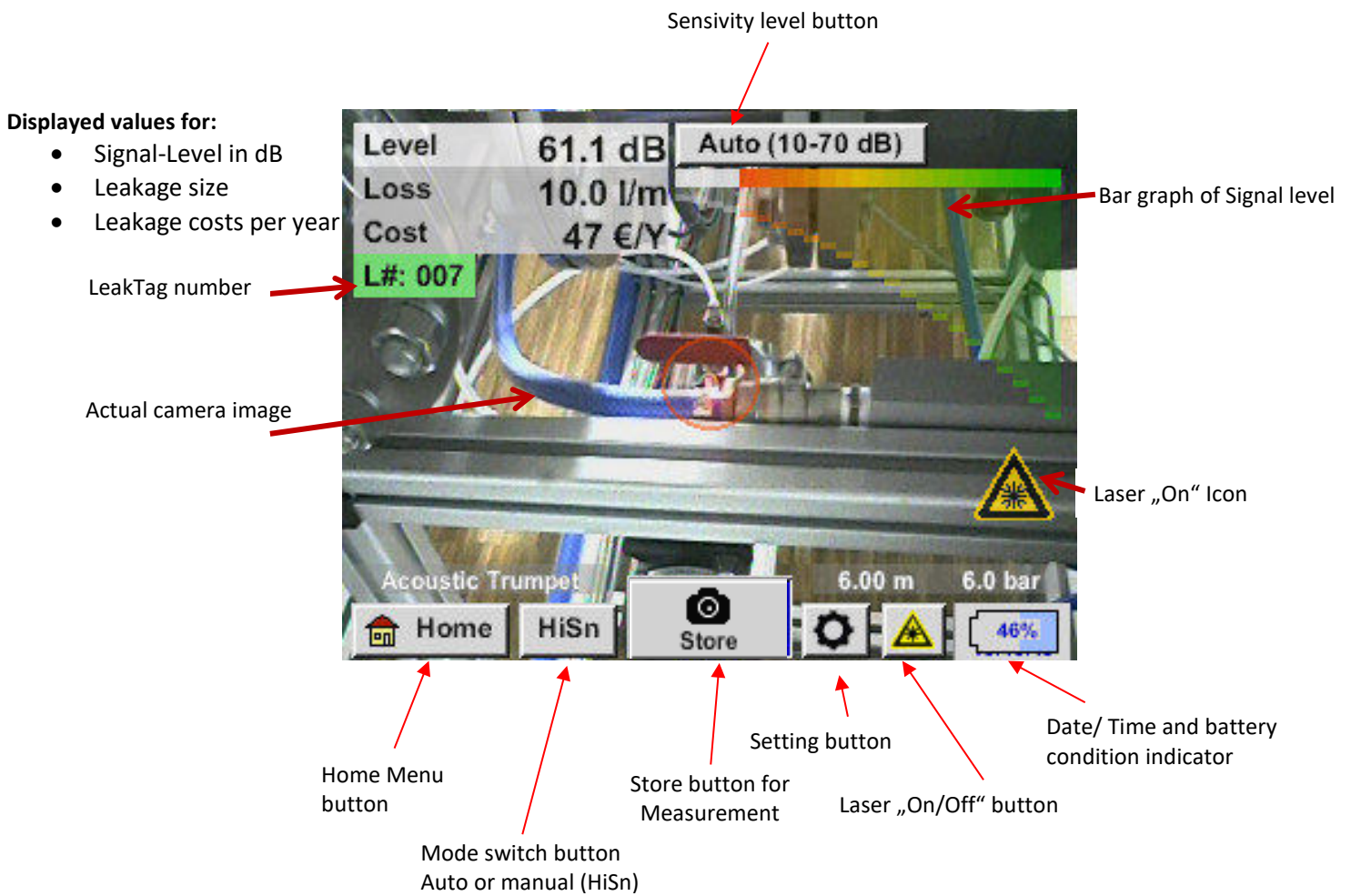

#### Date / Time:

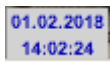

#### Battery condtion indicator

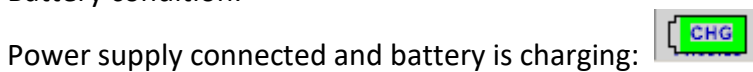
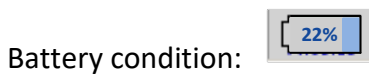

### 11.3 Home menu ILD 500

The operation is largely self-explanatory and menu-driven via the touch panel.

The selection of the respective menu items occur via short "tapping" with the finger or a soft round pen.

**Attention:** Please use no pens or other objects with sharp edges!  
The foil can be damaged!

Before the leakage search is started, the device must be configured. The user can access the menu by clicking the "Home" button. The following figure shows the Home "Menu".

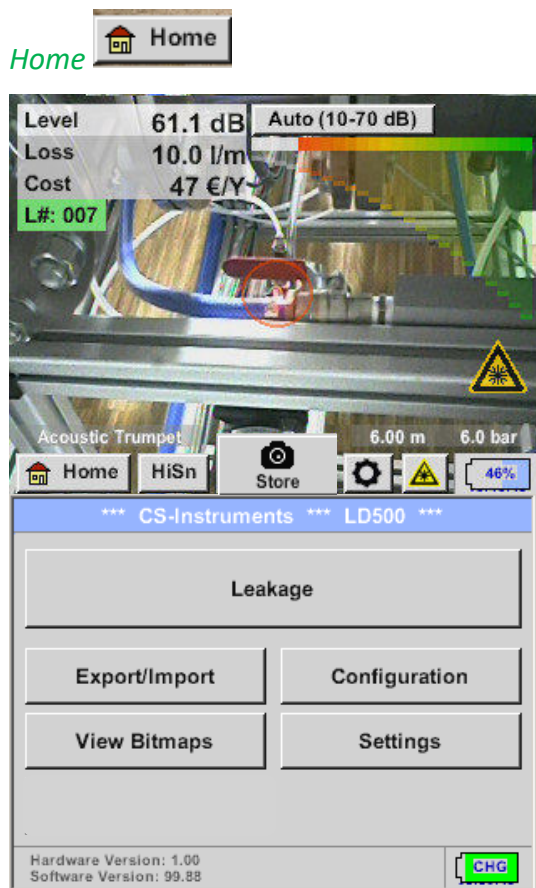

With the button „**Home**“ you access the basic menu of the ILD 500.

Return to measurement by pressing „**Leakage**“ –button.



### 11.3.1 Configuration of ILD500

Home → Configuration

In the configuration settings the unit system can be selected and the required parameters entered, this to calculate the leakage costs per year.

- Selection of ISO or US unit system
- Call up the text field "Costs/ 1000 m<sup>3</sup>" to define the costs. There are 2 variants to choose from:
  - **Standard:** Cost per 1000 volume units  
Enter cost and the currency  
Default value: 19 € / 1000 m<sup>3</sup> or 0.538€/1000cf
  - **Expert:** Here you can see in detail the electricity costs / kWh and define the specific power of the system. For the specific power 3 pre-defined asset values are created and a user defined input field for the individual input is made available.
- Enter working hours per year

Home → Configuration → Parameter

- Sensor type  
Selection of the sensor type according to the application and ambient conditions, see therefor chapter 6.
- Pressure (line pressure in bar)
- Distance (distance to leakage in m)

Depending on the selected sensor type, there are up to 4 pre-defined pressure and distance values that can be selected directly as well as two fields (white) in which values for the pressure and the distance are freely selected..

The **pressure** can be set variably between 1 - 10 bar.

For the **different sensor types** different **minimum and maximum distances** from the ILD500 to the leakage are defined to calculate valid leakage loss and costs per year. These distances must be strictly adhered to.

Home → Configuration → Meas.Point

The measuring point is stored for each leakage in its journal data. These can be seen later in the leakage report in the software.

→ LeakTag: will be automatically increased by one after storing a measurement.

All information about the measuring point can be changed by selecting the corresponding text field or the stored measuring points can be loaded from the internal database.

Then a menu opens with the available / saved entries. When selecting a saved value, select it (highlighted in green) and then take over with „**OK**“.

If a new entry is necessary, the input menu opens after pressing the „**new**“ button.

Input is accepted via „**OK**“.

This procedure is analogous to enter the information for company, building and location.

Using the „**delete**“ button, individual entries can be deleted too.

### 11.3.1.1 Sensortype selection (Measuring tool)

In order to simplify the leak detection for the user, various tools for different measuring conditions have been developed .

The distances mentioned for quantifying the leakage always refer to the front of the respective tool.



If the parabolic mirror / gooseneck has been ordered separately, the application data for the devices must be loaded into the ILD500 first. Data is supplied via USB stick.

**Import:**

Home → Export/Import → Import new Tool → Parabolic Mirror / Gooseneck Serial Number

### 11.3.1.2 Storing of the measurement

To store the measurements please press either the button „Store“ on the foil keypad, see chapter [Device components and controls](#) , or by button „Store“  in the display.

All data are stored on to the internal SD card.

The measurement data, the measurement point and the image of the measurement point are saved as a journal, which can be exported later and a report can be created with the Leak Reporter (order no.: 0554 0105).

After pressing one of the two „Store“ keys, the corresponding information for the measuring point must be completed. The measuring point information of the last stored storage (company, building and location) is displayed, the numbering of the leaking tag is increased by 1.

e.g .:

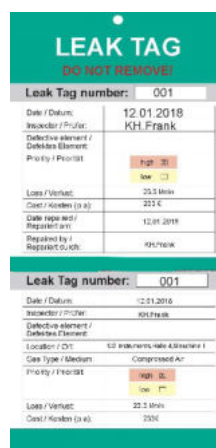
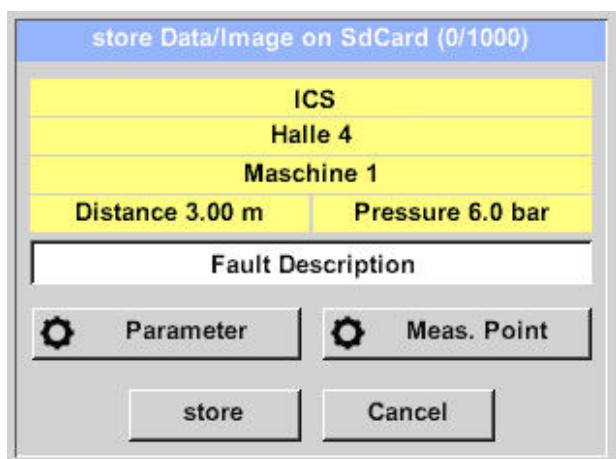

If necessary, fill out the Leak Tag-form and attach it to the measuring location.

Please use correct Leak Tag-number.

### 11.3.1.3 Parameter / Meas. Point (Re-Check)

Store → Parameter

Store → Meas. Point

At this point, it is again possible to check and correct the parameters „Pressure“ and „Distance“ and the measuring point.

Changing the parameters gives new values for leakage and cost.

Execution of the corrections see description [chapter 9.3.1](#)

### 11.3.1.4 Fault description

Store → Textfield Fault Description

In addition to the details of the measuring point with company, building and location, it is possible to enter a fault description (up to 32 characters).

To do this, select the text field „**Fault description**“ and enter the comment.

Here you can enter "short descriptions" for the individual fields.

The entries are also stored in an internal database so that they can be used again and again.

Some suggestions are already saved on delivery.

See left, for example the selection for the field "Leak. Element".

### 11.3.1.5 Storing measurement data to internal SD-card

Store → store

Before final storage of the measurement on the internal SD card, a summary is created and the correctness is queried once more for safety.

Storage is done with the „**Yes**“ key.

The „**No**“ key returns to the previous menu.

### 11.3.2 Export/Import

With *Home* → *Export / Import*,

- Recorded "Leakage data" can be transferred to a USB stick
- System settings can be exported as well as imported
- Measuring points (company, building and location data) can be exported as well as imported.
- Non-activated optional measurement tools can be activated/loaded.

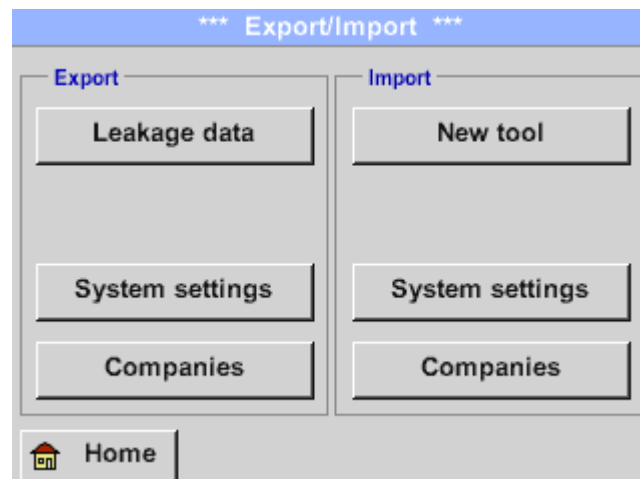

## 11.3.2.1 Export

### 11.3.2.1.1 Export „Leakage Data“

Home → Export / Import → Export → Leakage Data

The screenshots illustrate the steps in the 'Export Journal Data' process:

- Main Export Screen:** Shows 'start' and 'end' fields for Date, Time, Company, Building, and Measurement place. The 'Files to export' count is 3. Buttons include 'Back', 'ERASE Journal Data', and 'export'.
- Calendar Selection:** A calendar for February 2018 is shown. The date '1' (February 1st) is highlighted in green. Navigation arrows and an 'OK' button are at the bottom.
- Select from day 01.02.2018:** A table lists measurements for the selected date:
 

Time	Company	Building	Measurement place
10:23	CS Instru...	Halle 4	Maschine 1
10:28	CS Instru...	Halle 4	Maschine 1

 An 'OK' button is at the bottom.

With the help of the „**Change**“-button you can set a period between „**Start**“ and „**End**“.

Stored measurement data that lies within this period will be exported.

The selected date is always highlighted in green and the dates of the Sundays are - as in the calendar - red.

For days on which measurement data was recorded, the date numbers are visually exalted

If several measurements have been recorded on a date, they will appear after the date selection.

Now you can easily select the desired recording.

With „**OK**“, the start or end time is taken over.

Press the „**Export**“- button to transfer the selected data to the USB stick  
In the example given, 3 measurements are exported.

With „**ERASE Leakage Data**“ the Journal Database is deleted.

For verification is still a security question.

With „**Back**“ you return to the main menu.

**Attention:** With „**ERASE Journal Data**“ all journal data are deleted.

### 11.3.2.1.2 Export of System settings

This feature is especially relevant to the version ILD 510, here for storing the external sensor settings as well as e.g. display option for charts, sensor value etc.

Home → Export / Import → Export → System settings

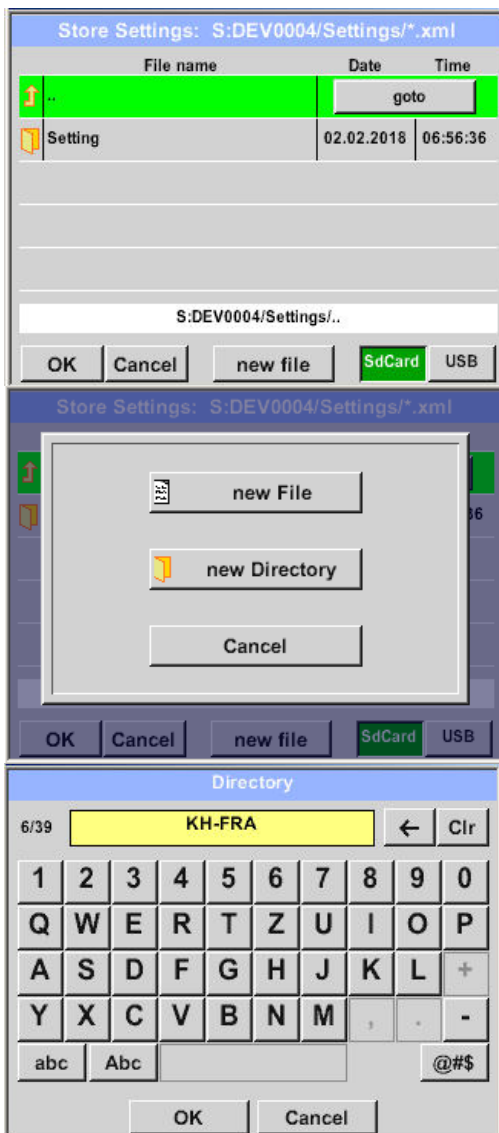

Here the definition of the storage location takes place

.Selection for internal SD card with activation of key „**SdCard**“ or on USB stick with key „**USB**“.

The selection of the desired folder is made by selecting and activating with „**goto**“ button.

If a new directory is required, this is done by pressing „**new File**“, this can be created by selecting „**new Directory**“

Saving a system file with a new name takes place analogously, then the key „**new File**“ must be pressed

Entries are to be confirmed with „**OK**“.

With „**Cancel**“ you return to the previous menu.

## 11.3.2.2 Import

### 11.3.2.2.1 Import of system settings

Home → Export / Import → Import → System settings

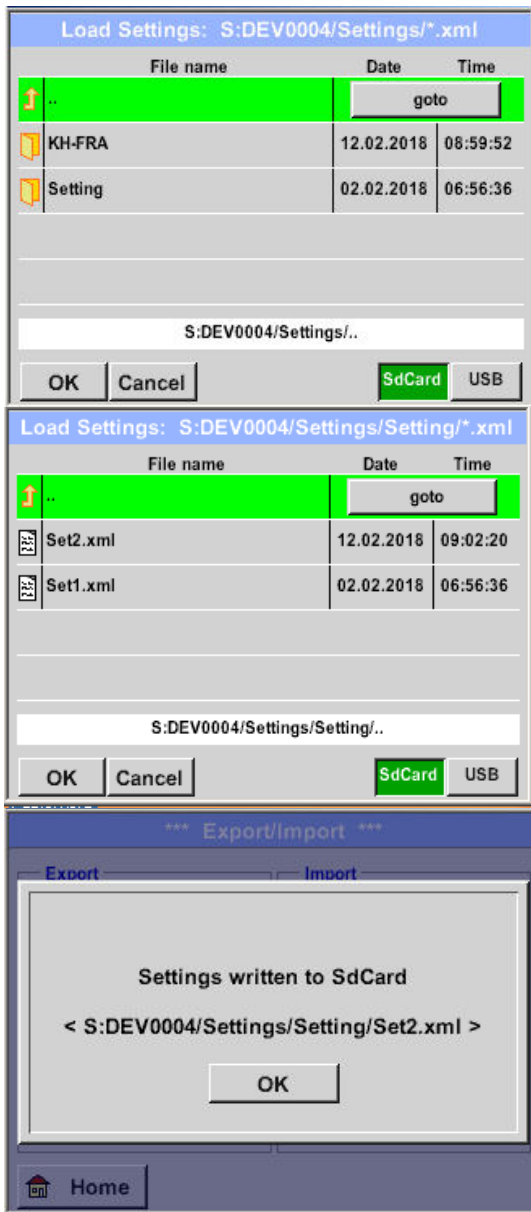

Sequence of directory and file selection is analogous to file export. Selection of internal SD card with activation of key „**SdCard**“ or on USB stick with key „**USB**“.

The selection of the desired folder is made by selecting and activating with the „**goto**“ button, then select corresponding system file.

Selection to be confirmed with „**OK**“.

Since system-relevant changes are made here, a confirmation prompt is issued, which must be confirmed with „**OK**“.



### 11.3.2.2.2 Import new measurement tool

Home → Export / Import → Import → Import new Tool

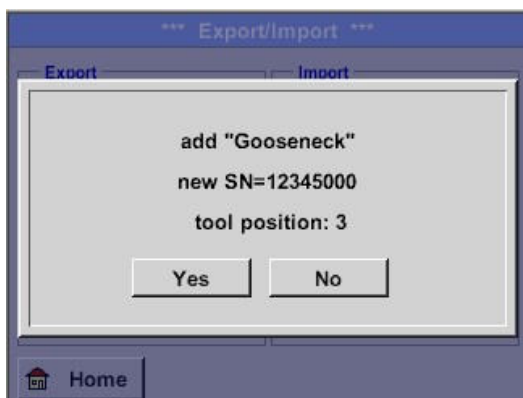
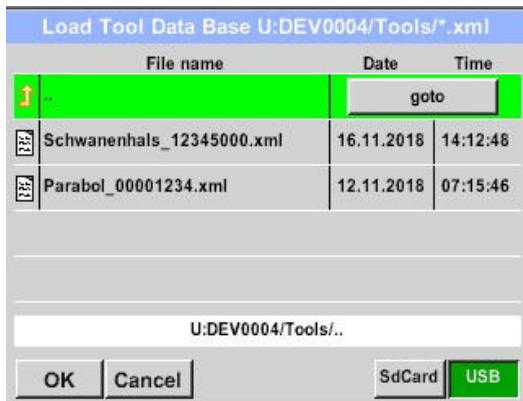

The directory and file selection process is the same as for export e.g. system settings Selection of internal SD card with activation of button **"SdCard"** or of USB stick with button **"USB"**.

Select the desired folder by pressing the **"goto"** key and then the corresponding system file.

Confirm your entries with **„OK“**.

Since system relevant changes are made here, a security query is made which must be confirmed with **"Yes"**.

### 11.3.2.3 Export / Import Customer database

These functions allow the stored measuring point descriptions (companies, buildings and location) to be exported as an XML file or to be imported from another ILD 500 exported database. That means it is also possible to create and import the database externally, but the prerequisite is the correct format of the XML file.

*Home → Export / Import → Export → Customers    Export / Import → Import → Customers*

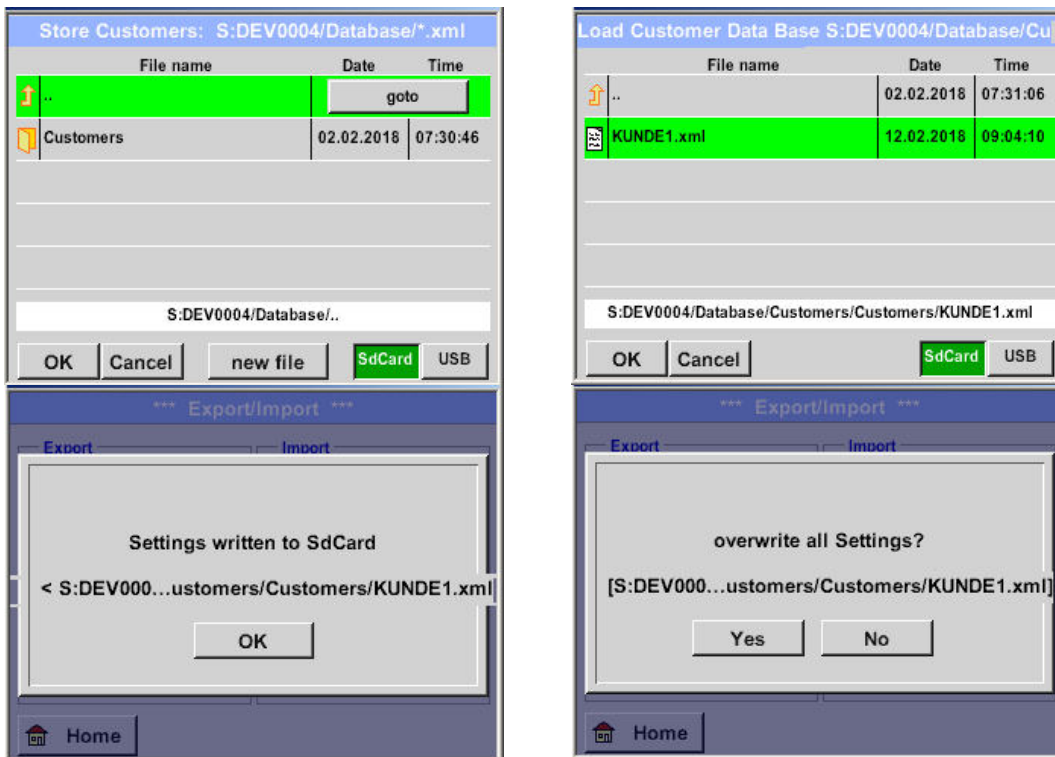

As data changes are made during importing, a confirmation question needs to be confirmed with „**Yes**“.

**Remark:** Customer data will be exported to folder [\\DEV0004/Database](#) .  
Data to be imported (XML files) must be stored in the directory [\\DEV0004/Database](#) as well.

### 11.3.3 View bitmaps

Home → View Bitmaps → Select Screenshot

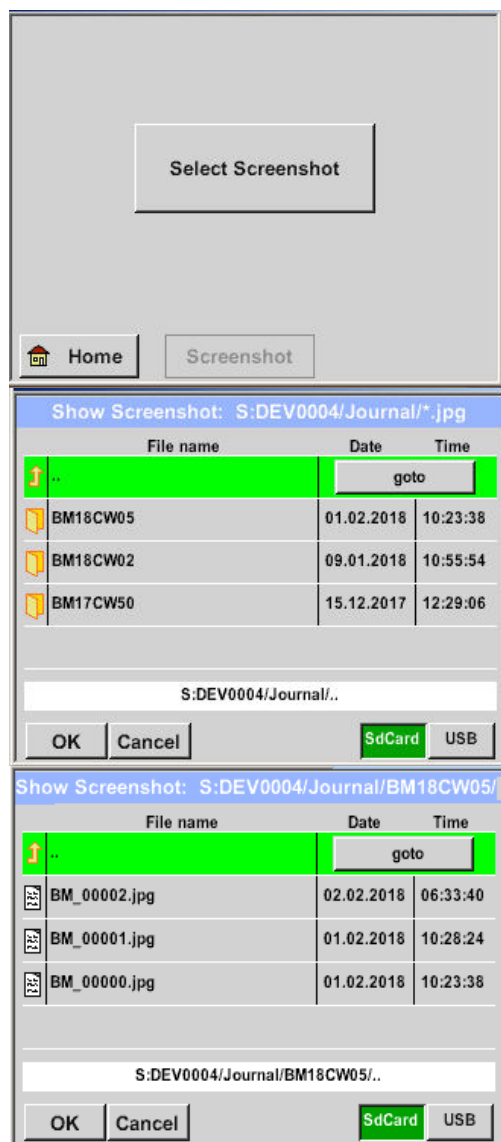

This allows the stored pictures (measurement pictures) on the SD-Card or USB Stick to load and shown in the display again.

Please press button „Select Screenshot“ and select the required picture (bitmap).

The pictures are stored and organized in different directories

The directory structure is year / calendar week

Designation: BMyyCWxx

yy = Year xx = calendar week

The selection of the desired folder is made by selecting and activating with the „goto“ button.

Select the desired image and then display with „OK“.

### 11.3.4 Device Settings

The settings are all protected by a password!

Settings or changes are generally confirmed with **OK**!

**Remark:**

If you go back to main menu and then again one of the setting menus is called, you must enter the password again.

Home → Settings



Overview of the *Settings*

#### 11.3.4.1 Passwort-Einstellung

Home → Settings → Passwort Settings

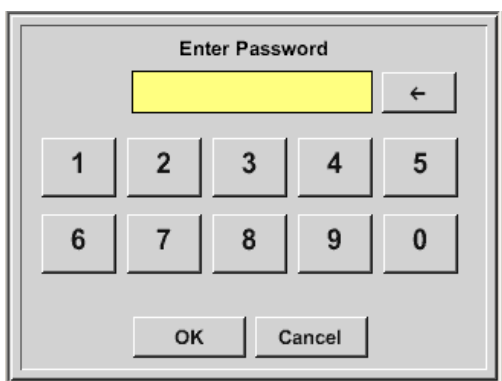

Factory settings for password at the time of delivery: 0000 (4 times zero).

If required, the password can be changed in the *Password settings*.

The new password must be entered two times in a row and in each case confirmed with **OK**

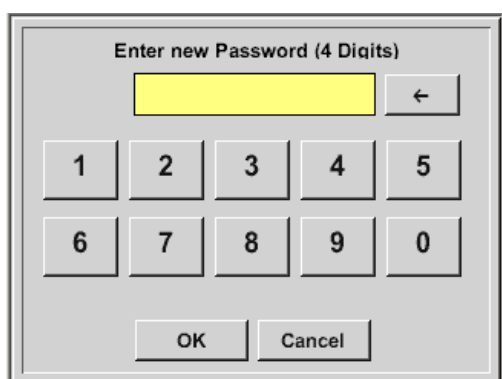

If an incorrect password is entered there appears *Enter password* or *New password repeat* in red font.

If you can't remember the password, please use Master password in order to enter a new password.

**Remark:**

The master password is supplied together with the instrument's documentation.

### 11.3.4.2 Device Settings

Home → Settings → Device settings

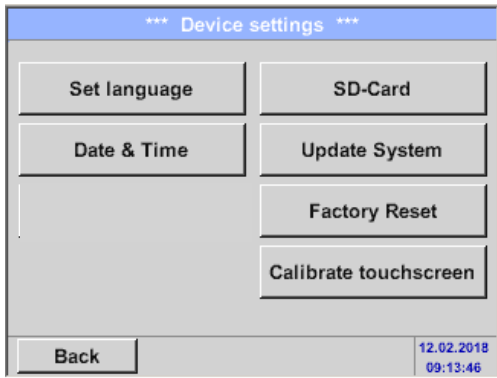

Overview of *Device settings*

#### 11.3.4.2.1 Language

Home → Settings → Device settings → Set language



Here you can select one of 11 languages for the ILD 500.

### 11.3.4.2.2 Date & Time

Home → Settings → Device settings → Date & Time

By pushing the *Time Zone* description field and enter the correct *UTC*, you can set the correct time all over the world.

The summer and wintertime switchover is realized by pushing the *Daylight Saving* button.

### 11.3.4.2.3 SD-Card

Home → Settings → Device settings → SD-Card → Reset Logger Database

Home → Settings → Device settings → SD-Card → Erase SdCard

By pressing *Reset Logger Database* all actual stored data on SD-Card will be blocked for use in ILD500 / ILD510. Nevertheless all data are still stored and available for external use only.

By pressing *Erase SdCard* all Data on the SD-Card will be deleted.

Home → Settings → Device settings → SD-Card → Test SdCard

With activation of *Test SdCard* data are written and read to and from the SD-card.

The number of test cycles, as well as possible errors and error codes are display in the status line.

Press the *Back* button to returns to the device settings menu.

#### 11.3.4.2.4 System update

If required, there is the possibility for the ILD 500 to download a firmware update to the device via the USB stick. The latest software is available on the homepage. The received file must then be stored on the USB stick and transferred to your device as described below.

Home → Settings → Device settings → System-Update

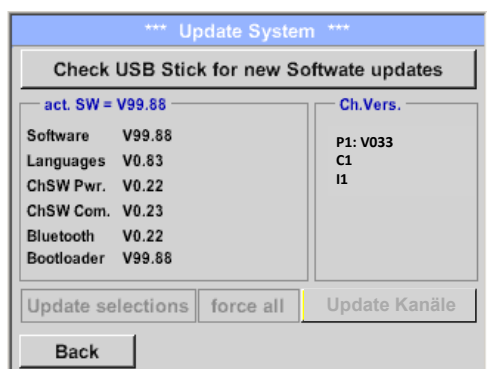

Overview of *System-Update*-Functions.

#### 11.3.4.2.5 Check for Updates

Home → Settings → Device settings → System-Update → check USB-Stick for new Updates

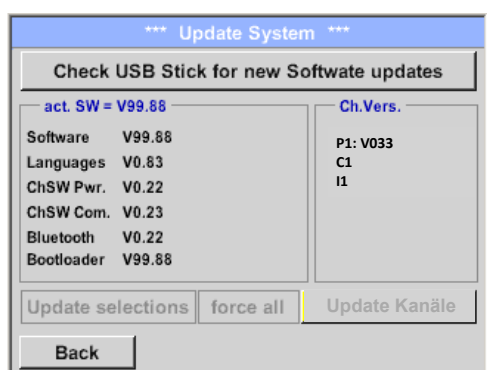

If after pressing the button *“Check USB Stick for new Software updates”* the following messages appear in the window, the ILD 500 is not properly connected to the USB flash drive or there are no files available.

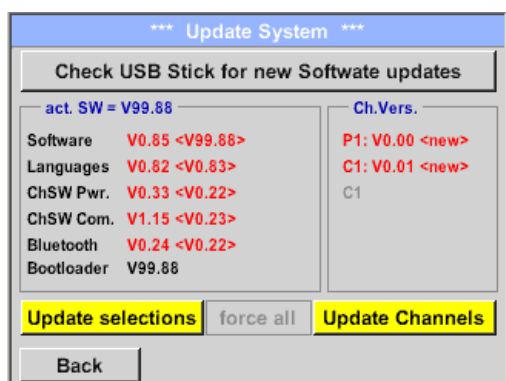

If the ILD 500 is correctly connected to the USB stick and there are new versions of the individual SW Parts, the new versions are marked in red.

The update is started by pressing the *„Update selections“* button.

If it is required to install an older software version, you have press the button *„Force all“*

### 11.3.4.2.6 Update Channels

Home → Settings → Device settings → System-Update → Update-Channels

If there is an update either for the internal and external channel (ILD 510 only), it must be started separately

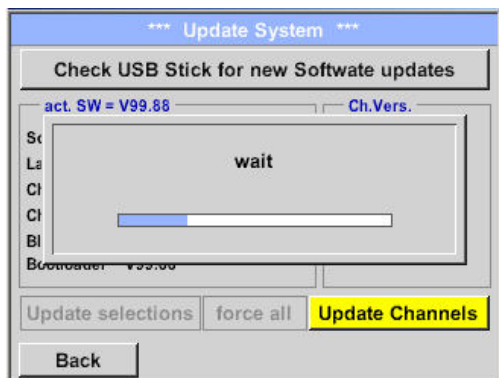

Update of the Channels ILD 500/ 510.

#### **Important:**

If the *Reboot system* button appears after the update, it must be pushed to restart the ILD 500!

### 11.3.4.2.7 Factory Reset

#### 11.3.4.2.7.1 Reset to default settings

Home → Settings → Device settings → System → Reset to Defaults

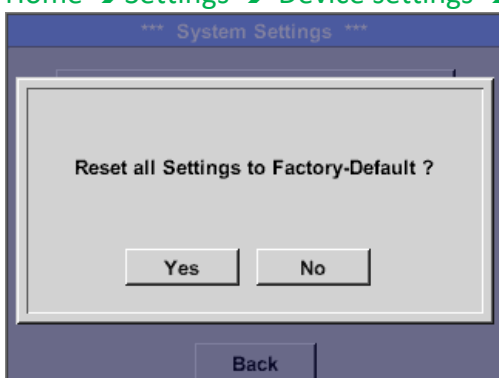

Bevor the settings are changed to the production default settings a safety prompt is displayed and must be confirmed by pressing the button „**Yes**“.

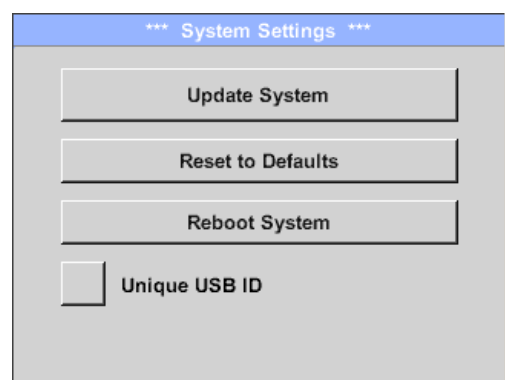

If needed with „**Reboot System**“ the ILD 500 could be started(reboot) here.

### 11.3.4.2.8 Unique USB ID

For connections with the PC, a status and therefore a unique USB ID can be defined here. Relevant for simultaneous connection of several USB devices to the PC.



### 11.3.4.2.9 Calibration of touchpanel

Home → Settings → Device settings → calibrate touchscreen

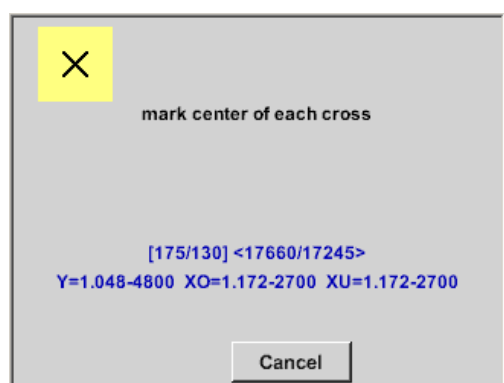
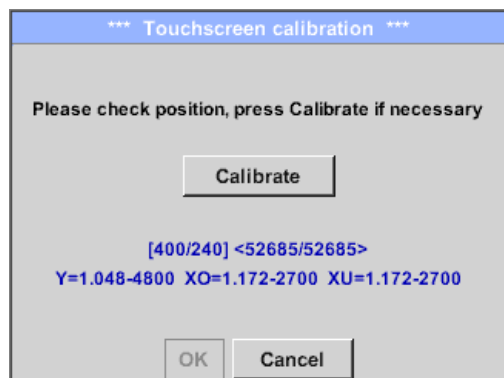

If necessary, the touch-screen calibration can be changed here.

Push *Calibrate* and it appears, 1. left above, 2. bottom right, 3. bottom left, 4. right above and 5. in the middle, a calibration cross that must be pushed consecutively.

If the calibration finished positive a message "*Calibration successful*" appears and have to be confirmed with *OK*.

Is this not the case, so you can repeat the calibration with the help of the *Cancel* and *Calibrate* button.

### 11.3.4.2.10 Set backlight brightness

Home → Settings → Set backlight

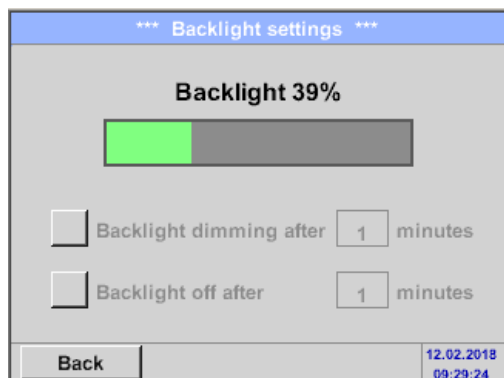

Here you adjust the desired *Backlight* (15-100%) of the display directly.

E.g. *Backlight* to 39 %

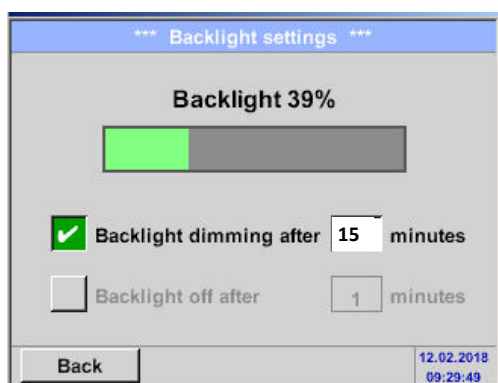

With the help of the *Backlight dimming after* button, after a definable time interval (here after 15 minutes), the *Backlight* can be reduced to the minimum.

As soon as the dimmed screen is operated again, the *Backlight* is committed automatically on the last set value before dimming.

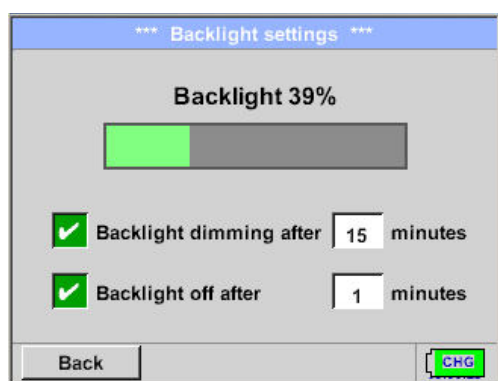

To reduce the energy consumption (device runtime), you can switch off the display backlight by setting "*Backlight off after*".

#### Remark:

At the first touch, the *Backlight* in our example is reset to 39%, after that a "normal" function operation is possible.

#### Important:

If the *Backlight dimming after* button is not activated, then the *Backlight* stays permanently on, in the currently set brightness.

### 11.3.4.2.11 Cleaning

Home → Settings → Cleaning



This function can be used for cleaning the touch panel during running measurements.

If one minute is not enough time to clean, the process can be repeated at any time.

Is the cleaning faster finished, then you can push the *to abort press long* button (for one or two seconds) to cancel.

### 11.3.4.2.12 System-Status

Home → Settings → System-Status

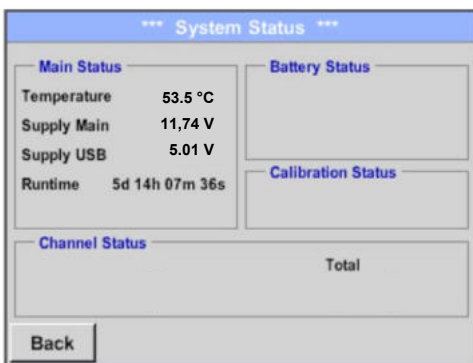

The menu item **“System status”** provides information about the power supply voltages and an operating hour counter.

### 11.3.4.2.13 About ILD 500

Home → Settings → about ILD

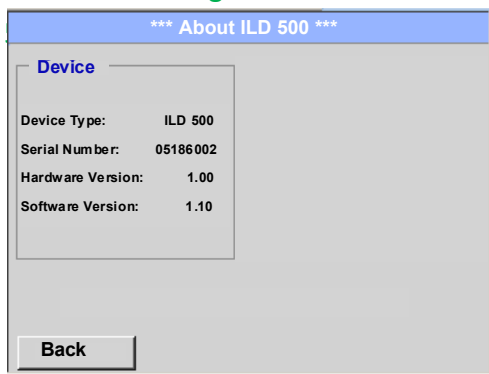

Brief description of the **Hardware** and **Software Version**, as well as the **Serial Number** of the ILD 500.

Under options, you can buy four additional, different functions, if you have not done this by ordering.

## 12 Charging the batteries

The battery is charged within the device. For this, the supplied plug-in power supply is connected to the built-in charging socket of the ILD 500 and the 230V socket.

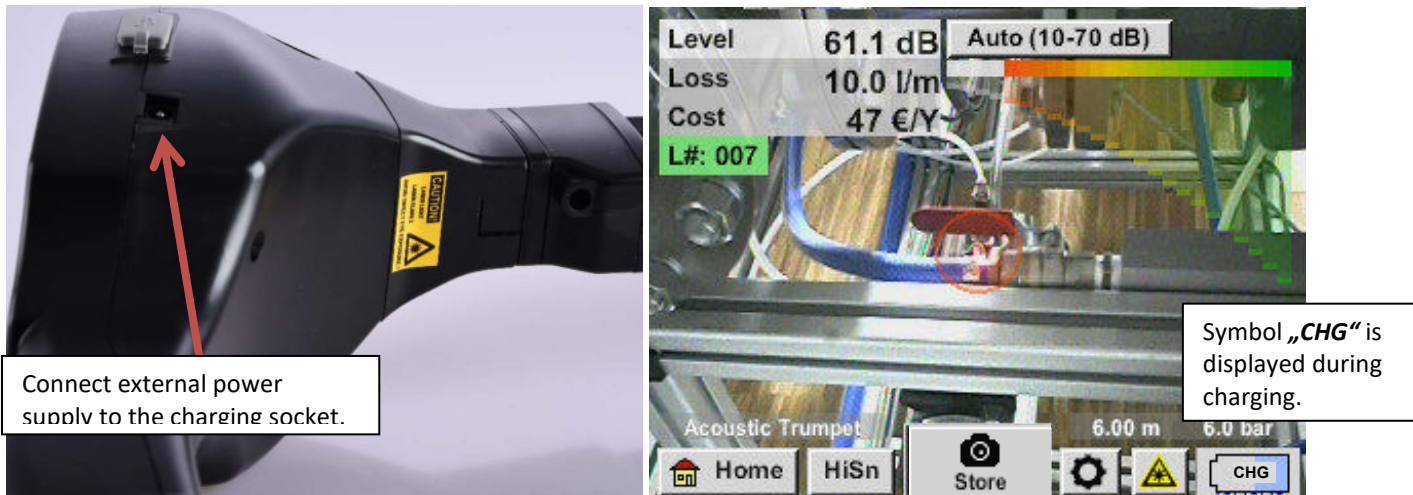

The ILD 500 checks the charging status of the battery and starts the charging process automatically if necessary.

To protect the Li-ION accumulator of exhaustive discharge the device is switching off automatically if a cell voltage of 6,4V will be reached.

## 13 ILD 510

### 13.1 Selection External sensor

The use of an „*external Sensor*“ requires to switch to its

mode. Home → Mode → Externer Sensor



Home menu for external sensor connection

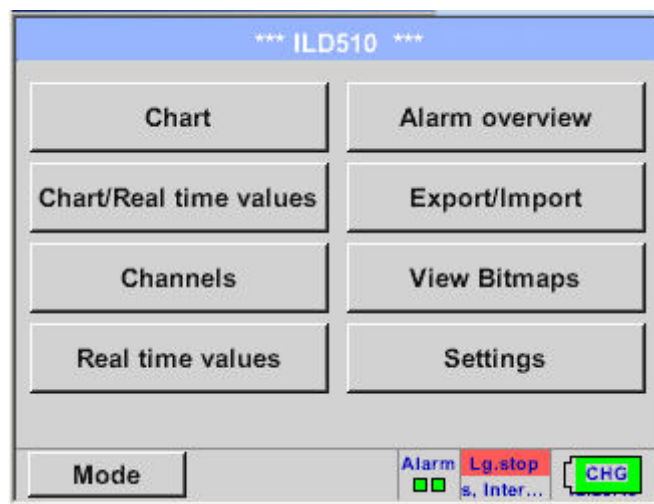

**13.2 Input signals of ext. sensor ILD510**

Input signals		
Current signal (0 – 20 mA / 4 – 20 mA) internal or external power supply	Measuring range	0 – 20 mA / 4 – 20 mA
	Resolution	0,0001 mA
	Accuracy	$\pm 0,03 \text{ mA} \pm 0,05 \%$
	Input resistance	50 $\Omega$
Voltage signal (0 - 1V)	Measuring range	0 - 1 V
	Resolution	0,05 mV
	Accuracy	$\pm 0,2 \text{ mV} \pm 0,05 \%$
	Input resistance	100 k $\Omega$
Voltage signal (0 - 10 V / 30 V)	Measuring range	0 - 10 V/30 V
	Resolution	0,5 mV
	Accuracy	$\pm 2 \text{ mV} \pm 0,05 \%$
	Input resistance	1 M $\Omega$
RTD Pt100	Measuring range	-200 - 850 °C
	Resolution	0,1 °C
	Accuracy	$\pm 0,2 \text{ °C}$ at -100 - 400 °C $\pm 0,3 \text{ °C}$ (further range)
RTD Pt1000	Measuring range	-200 - 850 °C
	Resolution	0,1 °C
	Accuracy	$\pm 0,2 \text{ °C}$ at -100 - 400 °C $\pm 0,3 \text{ °C}$ ( further range )
Pulse	Measuring range	minimal pulse length 100 $\mu\text{s}$ frequency 0 - 1 kHz max. 30 VDC

**13.3 Cable cross section****13.3.1 Sensor circuit points/Output signal:**

AWG26, cable cross-sections: 0.14 mm<sup>2</sup>

### 13.4 Connection diagrams for different sensor types

#### 13.4.1 Connector pin assignment for all sensors at PI 500

The interface connector to be used is a ODU Medi Snap 8 pin – Reference: K11M07-P08LFD0-6550

Available connection cables at are:

ODU with Open ends: Order no 0553 0501, cable length: 5 m.  
 Order no 0553 0502, cable length: 10 m.

ODU with M12 Connector: Order no 0553 0503, cable length: 5 m.

Extension cable (ODU/ODU): Order no 0553 0504, cable length: 10 m.

#### Connection scheme:

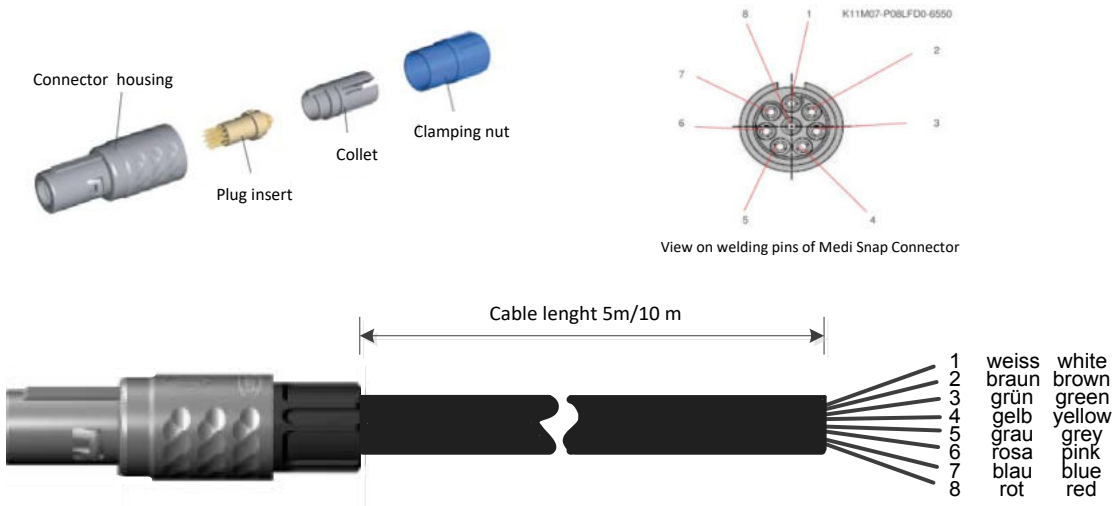

<table border="1"> <tr> <td>+ RS485</td> <td>● 1</td> <td>White</td> </tr> <tr> <td>- RS485</td> <td>● 2</td> <td>Brown</td> </tr> <tr> <td>SDI</td> <td>● 3</td> <td>Green</td> </tr> <tr> <td>Analog IN +</td> <td>● 4</td> <td>Yellow</td> </tr> <tr> <td>Analog IN -</td> <td>● 5</td> <td>Grey</td> </tr> <tr> <td>I (500µA)</td> <td>● 6</td> <td>Pink</td> </tr> <tr> <td>+VB 24Vdc</td> <td>● 7</td> <td>Blue</td> </tr> <tr> <td>-VB GND</td> <td>● 8</td> <td></td> </tr> </table>	+ RS485	● 1	White	- RS485	● 2	Brown	SDI	● 3	Green	Analog IN +	● 4	Yellow	Analog IN -	● 5	Grey	I (500µA)	● 6	Pink	+VB 24Vdc	● 7	Blue	-VB GND	● 8		<p><b>+ RS485</b></p> <p><b>- RS485</b></p> <p><b>SDI</b> (internal data transmission for all Dew point and Flow sensor IFA/ IVA 400)</p> <p><b>ANALOG IN +</b></p> <p><b>ANALOG IN -)</b></p> <p><b>STROMQUELLE 500 µA</b></p> <p><b>+VB, 24V DC Power supply for sensor</b></p> <p><b>-VB, GND Sensor</b></p>
+ RS485	● 1	White																							
- RS485	● 2	Brown																							
SDI	● 3	Green																							
Analog IN +	● 4	Yellow																							
Analog IN -	● 5	Grey																							
I (500µA)	● 6	Pink																							
+VB 24Vdc	● 7	Blue																							
-VB GND	● 8																								

### 13.4.2 Connection for dew point- and consumption sensors, series IFA/IVA 5xx

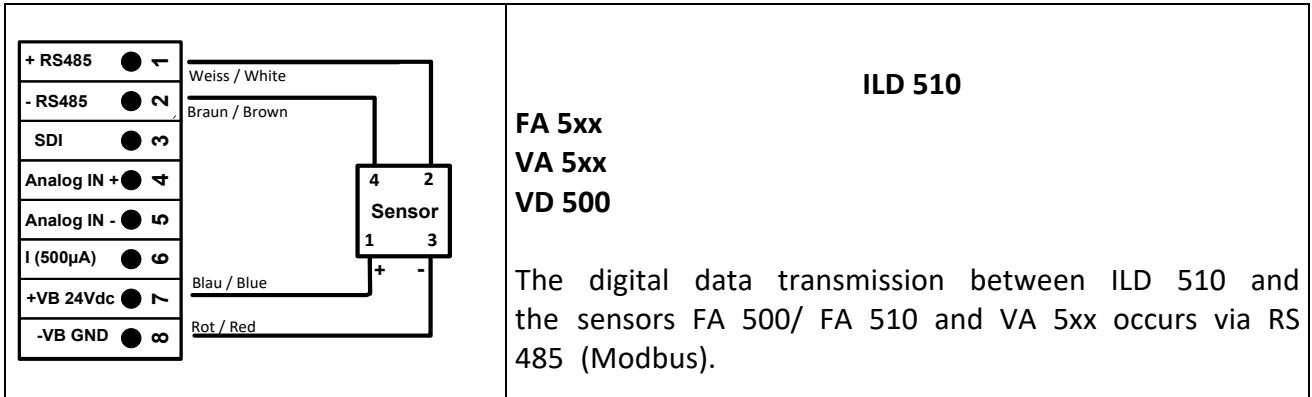

### 13.4.3 Connection with RS485

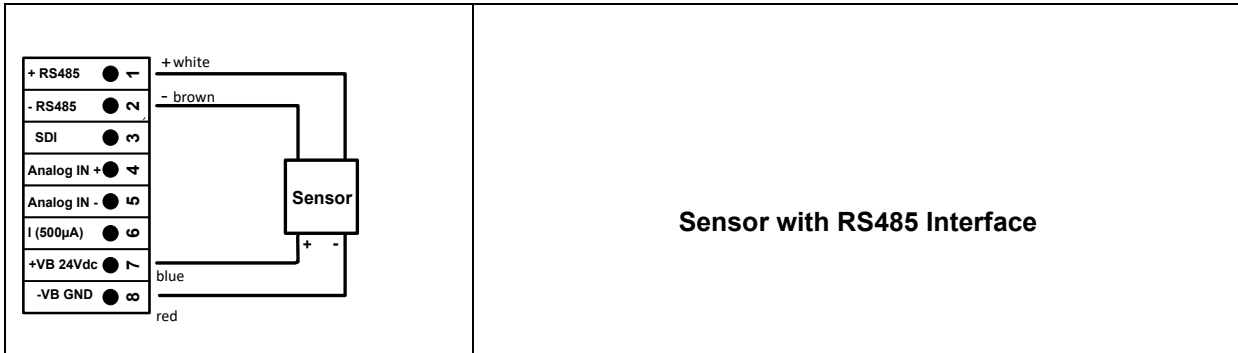

### 13.4.4 Three- and four-wire power supply 0 - 1/10/30 VDC

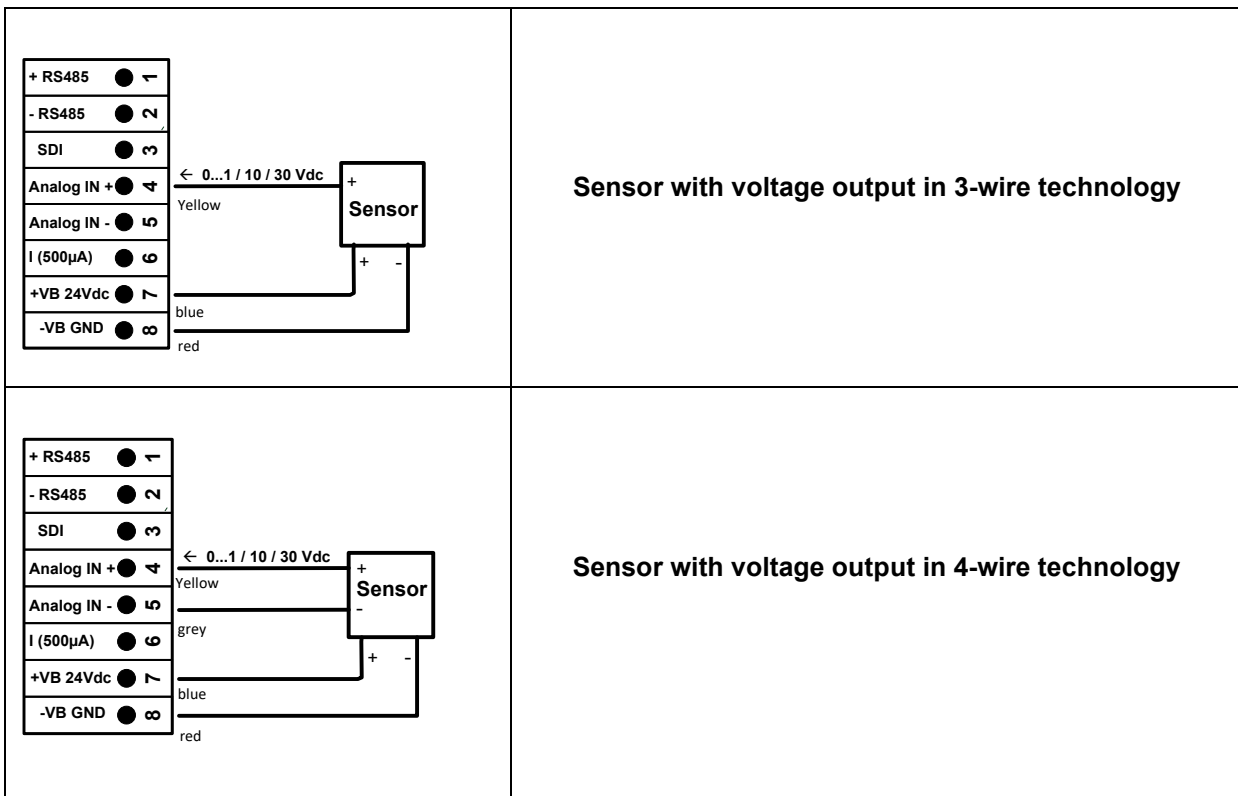



### 13.4.5 Analogue two-, three-, and four-wire current signal

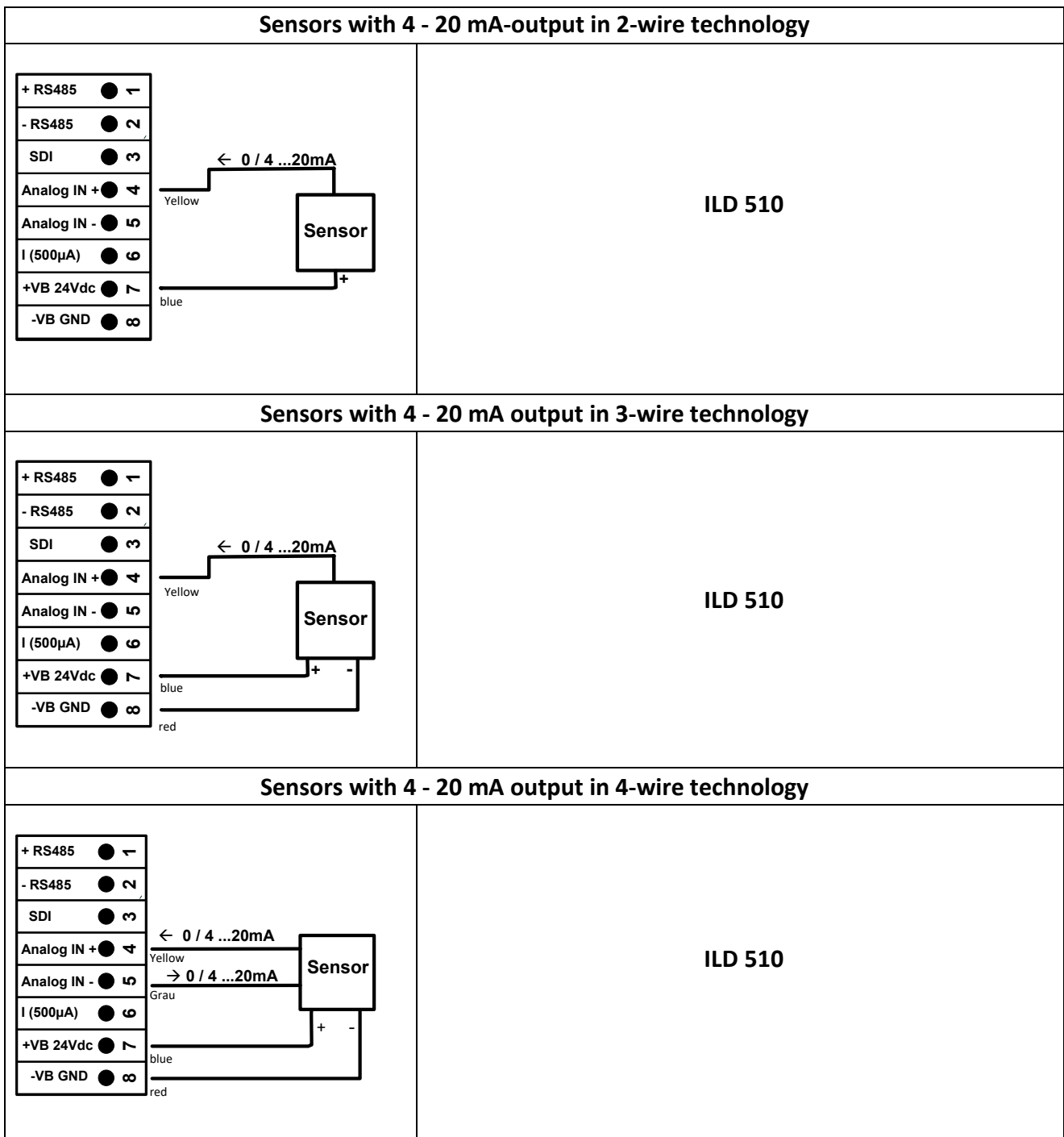

### 13.4.6 Two-, three- and four-wire connector pin assignments for PT100/PT1000/KTY81

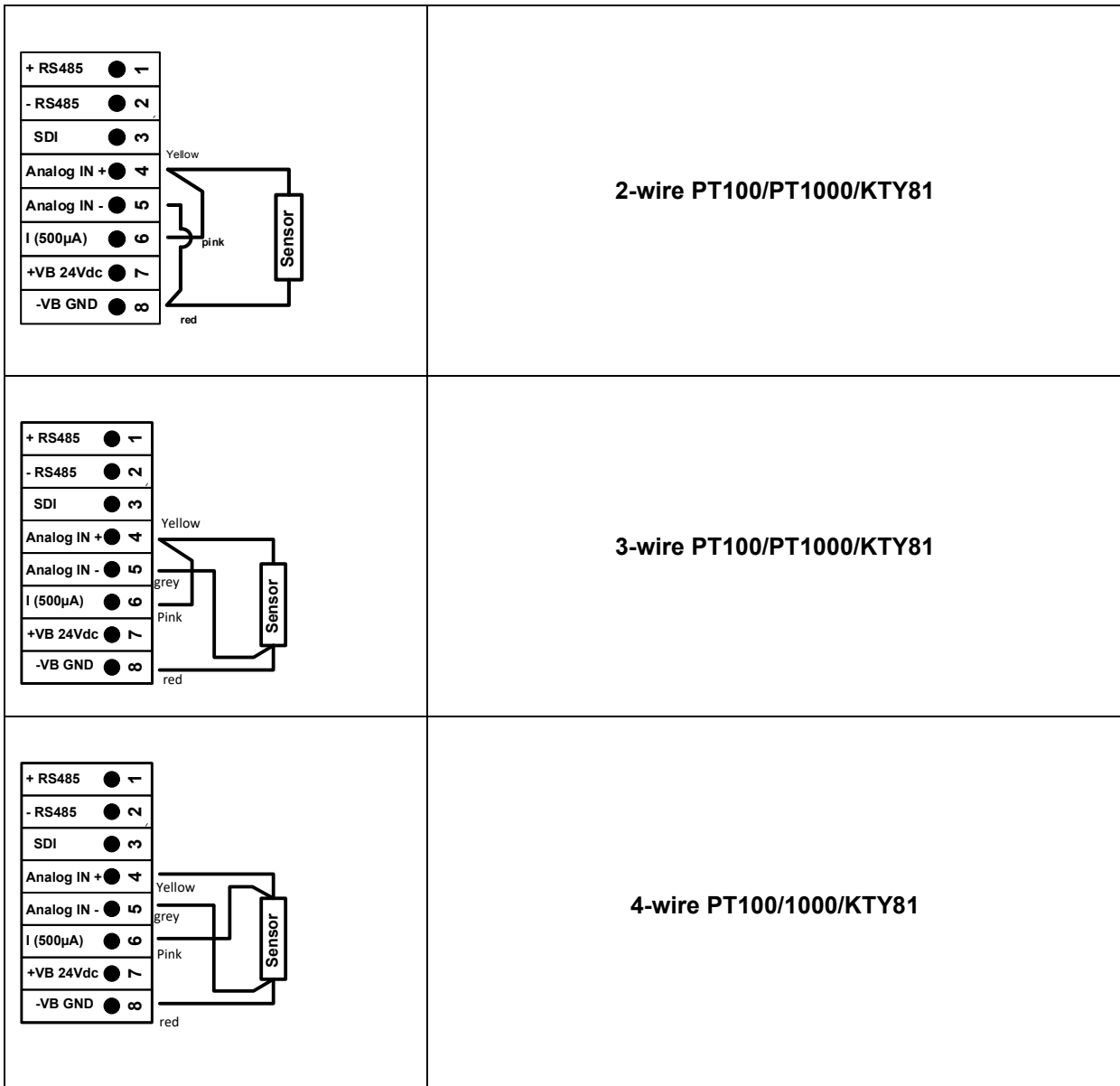

### 13.5 Dew Point Sensor FA 500 / FA 510 (RS 485 Modbus)

**First step:** choose an unused sensor digital channel

External sensor → Settings → Sensor settings → C1

**Second step:** choose type FA 5xx

External sensor → Settings → Sensor settings → C1 → description field → Dew Point → FA 5xx

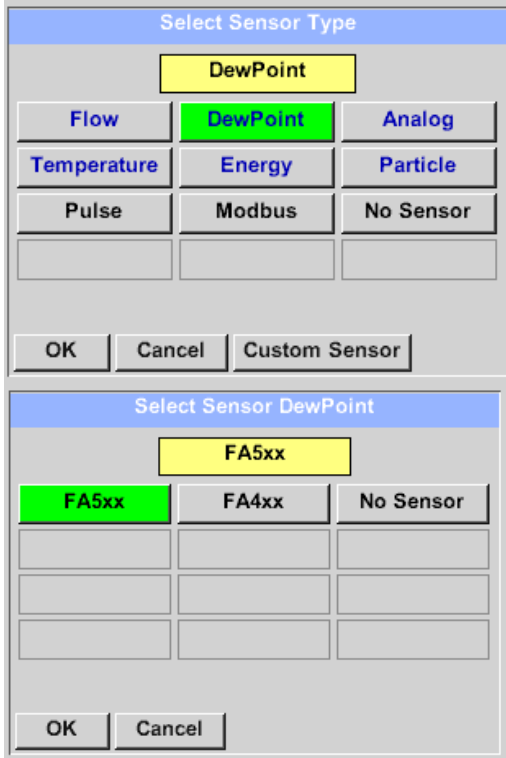

Now the *Type FA 5xx* is to be selected for the FA 5xx series and confirmed by pressing the "OK" button.

Select the "Dew point" variant in the category menu here and confirm with "OK".

Then activate the sensor variant "FA5xx" and confirm with "OK".

External sensor → Settings → Sensor settings → C1 → text field "Name"



For input of a name, please enter the text field „Name“.

It is possible to enter a name with max. 24 characters.

Confirmation by pressing the **OK**-button.

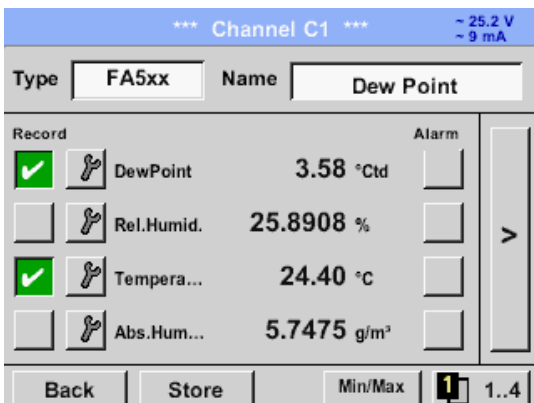

The connection with the FA 5xx sensor is done after confirmation by pressing "OK".

### 13.5.1 Settings Dew point sensor FA 500 / FA 510

#### 13.5.1.1 Unit selection for temperature and humidity

External sensor → Settings → Sensor settings → C1 → arrow right (2.page)

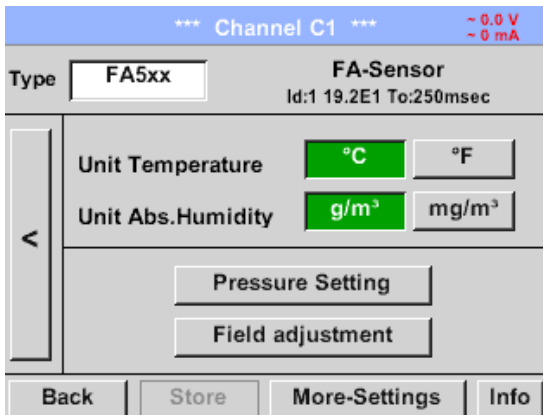

Unit selection for temperature and humidity by pressing the button °C, °F, g/m<sup>3</sup> or mg/m<sup>3</sup>.

Confirm the settings by pressing the OK button.

#### 13.5.1.2 Definition of the System pressure (relative pressure value)

External sensor → Settings → Sensor settings → C1 → arrow right (2.page) → Pressure Setting

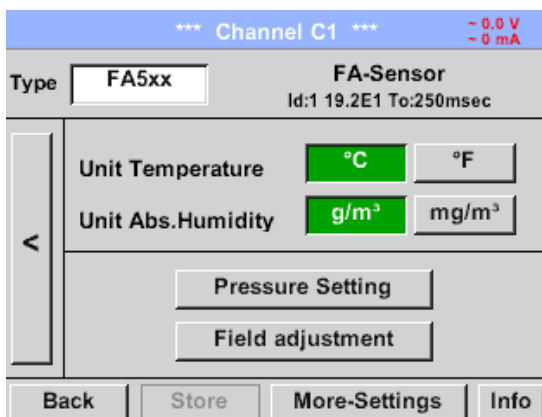

The system pressure is inserted by entering the values in the corresponding text field. The unit can be freely selected, selection menu is opened by pressing the corresponding button units

Confirm the settings by pressing the OK button.

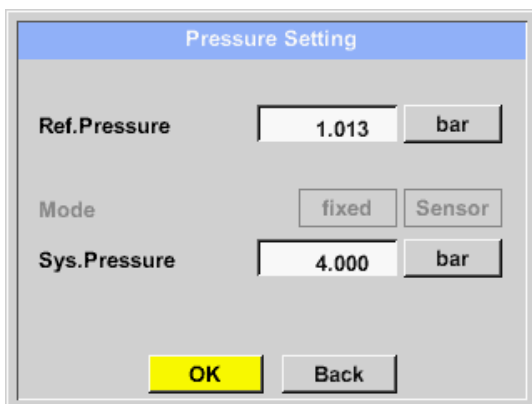

### 13.5.1.3 Definition of Reference pressure (absolute pressure value)

External sensor → Settings → Sensor settings → C1 → arrow right (2.page) → Pressure Setting → Text field Ref.Pressure

Pressure Setting

Ref.Pressure  mbar

Mode

Sys.Pressure  bar

Reference pressure is the pressure for that the dew point in relaxation will be back-calculated.

Default- Value is 1013 mbar (Atm. Pressure).

Confirm the settings by pressing the **OK** button.

### 13.5.1.4 Field adjustment

External sensor → Settings → Sensor settings → C1 → arrow right (2.page) → Field adjustment

Calibration

Realtime Value 26.45 °Ctd

Reference Value  °Ctd

Counter 0  Δ rel.Humid. 0.000 %rH

Here, a one-point adjustment can be performed.

For that purpose, please enter in the text box "**Reference Value**" the new correct dew point value.

Then by pressing the "**Adjustment**" button taking over the inserted reference value.

Calibration can be put back to factory setting by pressing „**Reset**“.

For each performed calibration, the counter is increased by 1.

(Channel C1) Field adjustment

Realtime Value -20.026 °Ctd

Reference Value  °Ctd

Counter 0  Δ rel.Humid. 0.000 %rH

### 13.5.1.5 More Settings Analogue output 4-20mA

External sensor → Settings → Sensor settings → C1 → arrow right (2.page) → More-Settings → 4-20mA

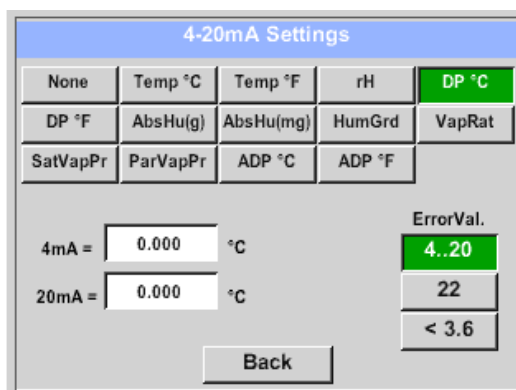
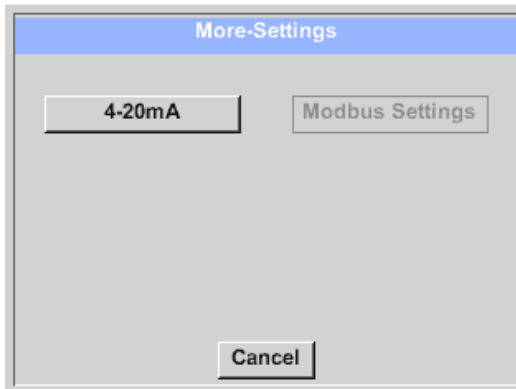

This menu allows the adjustment / assignment of the measurement value and the scaling of the analogue output.

Selection of the measurement value by selecting the appropriate measured value key in this example, "DP °C" for dew point °Ctd.

In text fields "4mA" and "20mA" the appropriate scaling values are entered, here from -80° Ctd (4mA) to -20° Ctd (20mA).

With "Error Val" is determined what is the output in case of error at the analog output.

- <3.6 Sensor error / System error
- 22 Sensor error / System error
- 4..20 Output according Namur (3.8mA – 20.5 mA)  
< 4mA to 3.8 mA Measuring range under range  
>20mA to 20.5 mA Measuring range exceeding

### 13.6 Flow sensor of type VA 500 / VA 520 / VA 550 / VA 570 (RS 485 Modbus)

**First step:** choose an unused sensor digital channel

External sensor → Settings → Sensor settings → C1

**Second step:** choose type VA 5xx

External sensor → Settings → Sensor settings → C1 → Type description field → VA 5xx

The first screenshot shows a dialog titled "Select Sensor Type". It has a grid of buttons: "Flow" (highlighted in yellow), "DewPoint", "Analog", "Temperature", "Energy", "Particle", "Pulse", "Modbus", and "No Sensor". Below the grid are "OK", "Cancel", and "Custom Sensor" buttons.

The second screenshot shows a dialog titled "Select Sensor Flow". It has a grid of buttons: "VA5xx" (highlighted in yellow), "VA4xx", and "No Sensor". Below the grid are "OK" and "Cancel" buttons.

Now the *Type VA 5xx* is selected for the VA 5xx series and confirmed by pressing the *OK* button.

Select the *"Flow"* variant in the category menu here and confirm with *"OK"*.

Then activate the sensor variant *"VA5xx"* and confirm with *"OK"*.

External sensor → Settings → Sensor settings → C1 → Name description field

The screenshot shows a configuration screen for "Channel C1". At the top, it displays "Type: VA5xx" and "Name: Flow Sensor". Below this is a "Record" section with a table:

Record	Icon	Parameter	Value	Alarm
<input checked="" type="checkbox"/>	Flow	Stopped		<input type="checkbox"/>
<input checked="" type="checkbox"/>	Consumpt.	Stopped		<input type="checkbox"/>
<input type="checkbox"/>	Velocity	Stopped		<input type="checkbox"/>
<input type="checkbox"/>	Temp.	Stopped		<input type="checkbox"/>

Below the table is a numeric keypad and a "Name" input field with a cursor. The "Name" field contains "Flow Sensor".

Input of a name, please enter the text field *„Name“*.

It is possible to enter a name with max. 24 characters.

Confirmation by pressing the *OK*-button.

The screenshot shows the same configuration screen as above, but now the "Record" section is populated with values:

Record	Icon	Parameter	Value	Alarm
<input checked="" type="checkbox"/>	Flow	0.00 m <sup>3</sup> /h		<input type="checkbox"/>
<input checked="" type="checkbox"/>	Consumpt.	0 m <sup>3</sup>		<input type="checkbox"/>
<input type="checkbox"/>	Velocity	0.00 m/s		<input type="checkbox"/>
<input type="checkbox"/>	Temp.	24.13 °C		<input type="checkbox"/>

At the bottom, there are "Back", "Store", and "Min/Max" buttons.

The connection with the VA 5xx sensor is done after confirmation by pressing *"OK"*.

### 13.6.1 Settings for Flow sensor VA 5xx

External sensor → Settings → Sensor settings → C1 → arrow right (2.page)

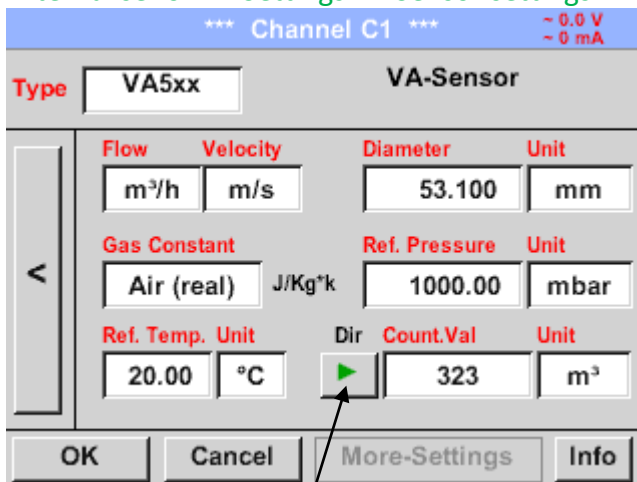

In case of a bidirectional sensor (VA5xxB) can be changed here by pressing the key to switches the other direction and thus the second counter reading is entered

For each text field could be the either a value or a unit be set.

Settings by entering the text field and then input a value or select the unit for the appropriate field.

In case of VA 520 and VA 570 with integrated measuring section the diameter and diameter unit field are not accessible.

All inputs/changes have to be confirmed with **“OK”**.

#### 13.6.1.1 Diameter settings (only for VA 500 or VA 550)

External sensor → Settings → Sensor settings → C1 → arrow right (2.page) → diameter description field

External sensor → Settings → Sensor settings → C1 → arrow right (2.page) → diameter unit description field

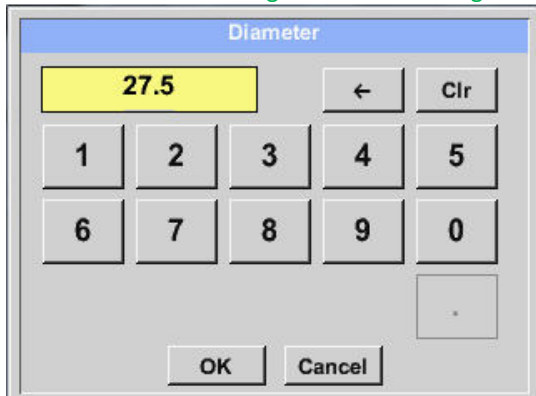

**Important:**

Only for VA 500 or VA 550 possible to change the **inner diameter**

Here the **“inner diameter”** is set to 27.5mm.

Please confirm by pressing the **OK** button and go back with **arrow left (1.page)**.

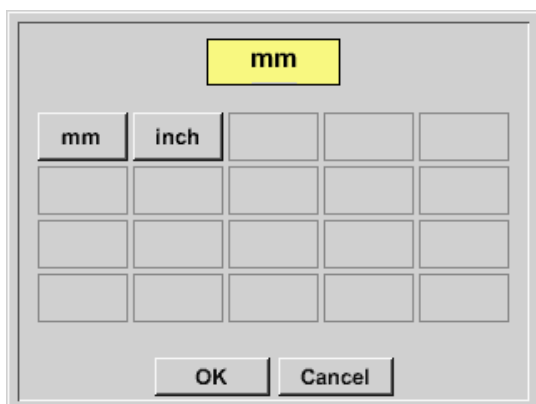

After pressing the **Unit** Text fields following units are selectable.

**Important:**

The **inner diameter** should be entered as precisely as possible, because otherwise the measurement results are not correct!

There is no uniform standard for the tube **inner diameter**!

(Please inquire it from the manufacturer or measure it by your own!)



### 13.6.1.2 Gas Constant settings

External sensor → Settings → Sensor settings → C1 → arrow right (2.page) → Gas Constant description field

Air (real)		
Air (real)	CO2 (real)	H2 (real)
NO2 (real)	CO2 (188.9)	N2O (187.8)
N2 (296.8)	O2 (259.8)	NG (446.0)
Ar (208.0)		
OK		Cancel

All gases marked in blue and with (real) have been a real gas calibration curve stored in the sensor.

Select the gas you require and confirm selection by pressing **OK** button.

#### Attention:

**Reference temperature and reference pressure (factory setting 20 °C, 1000 hPa):**

All volume flow values (m<sup>3</sup>/h) and consumption values indicated in the display are related to 20 °C, 1000 hPa (according to ISO 1217 intake condition)

0 °C and 1013 hPa (= standard cubic meter) can also be entered as a reference.

**Do not enter the operation pressure or the operation temperature under reference conditions!**

### 13.6.1.3 Definition of the reference conditions

Here, the desired measured media reference conditions for pressure and temperature can be defined

External sensor → Settings → Sensor settings → C1 → arrow right (2.page) → Ref. Pressure description field

External sensor → Settings → Sensor settings → C1 → arrow right (2.page) → Ref. Pressure Unit description field

The first screenshot shows a numeric keypad titled "Ref. Pressure" with the value "1000" displayed. The keypad includes buttons for digits 0-9, a decimal point, a left arrow, and a "Clr" button. Below the keypad are "OK" and "Cancel" buttons.

The second screenshot shows a unit selection screen titled "mbar" (highlighted in yellow). It features a grid of buttons for units: "mbar", "psi", "hpa", and several empty cells. "OK" and "Cancel" buttons are at the bottom.

External sensor → Settings → Sensor settings → C1 → arrow right (2.page) → Ref. Temp. description Field

External sensor → Settings → Sensor settings → C1 → arrow right (2.page) → Ref. Temp. Unit description Field

The first screenshot shows a numeric keypad titled "Ref. Temp." with the value "20" displayed. The keypad includes buttons for digits 0-9, a decimal point, a left arrow, and a "Clr" button. Below the keypad are "OK" and "Cancel" buttons.

The second screenshot shows a unit selection screen titled "°C" (highlighted in yellow). It features a grid of buttons for units: "°C", "°F", and several empty cells. "OK" and "Cancel" buttons are at the bottom.

### 13.6.1.4 Definition Unit of flow and velocity

External sensor → Settings → Sensor settings → C1 → arrow right (2.page) → Flow description Field

External sensor → Settings → Sensor settings → C1 → arrow right (2.page) → Velocity description Field

The first screenshot shows a unit selection screen for flow with "m³/h" highlighted in yellow. The grid contains various flow units: m³/h, Nm³/h, m³/min, Nm³/min, ltr/h, Nltr/h, ltr/min, NI/min, ltr/s, NI/s, cfm, SCFM, kg/h, kg/min, kg/s, and kW. "OK" and "Cancel" buttons are at the bottom.

The second screenshot shows a unit selection screen for velocity with "m/s" highlighted in yellow. The grid contains various velocity units: m/s, Nm/s, fpm, SFPM, and several empty cells. "OK" and "Cancel" buttons are at the bottom.

### 13.6.1.5 Definition consumption counter value and consumption unit

External sensor → Settings → Sensor settings → C1 → arrow right (2.page) → Count Val. description Field

External sensor → Settings → Sensor settings → C1 → arrow right (2.page) → Count Val. Unit description Field

The sensor allows taking over a starting counter value. Inserting the value by entering the "Count. Val." text field.

In the Count. Val. Unit field different units could be used. Selection by activation of the "Count. Val. Unit" text field

In case the counter value unit will be changed only the consumption counter value will be recalculated to the appropriate unit.

Selection to confirm selection by pressing **OK** button.

Shift key Counter reading for VA5xxB

**Remark:**

After confirmation with **OK**, the font is black again and the values and settings are accepted

### 13.6.1.6 Settings analogue output 4-20mA of VA 5xx

External sensor → Settings → Sensor settings → C1 → → arrow right (2.page) → More-Settings → 4-20mA Ch1

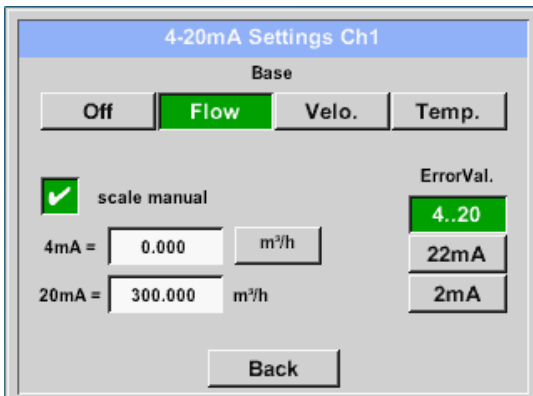
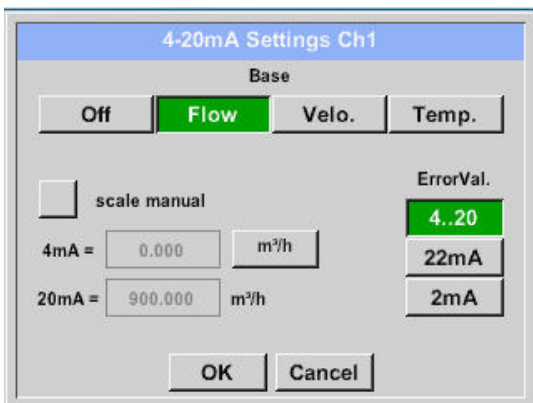
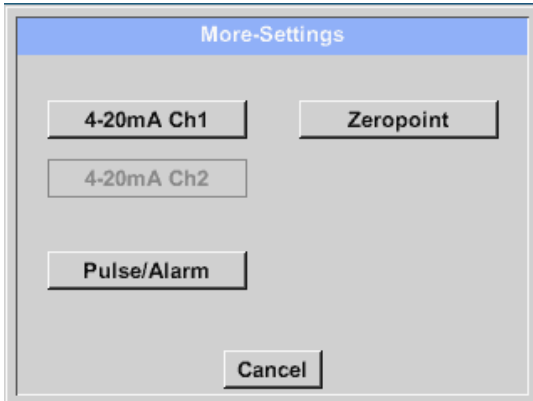

This menu allows the adjustment / assignment of the measurement value and the scaling of the analogue output by pressing the "4-20mA Ch1" button.

Selection of the analogue output measurement value by activating the appropriate measured value key in this example, "Flow".

Possible outputs are flow, velocity and temperature. In case of no use, please select "Off".

The analogue output scaling have to possibilities, automatic scaling (default) and a manual scaling by the user. Auto scaling is based on the calibration settings, means 4mA is set to zero and the 20mA value is based on the max. settings here 900m<sup>3</sup>/h

A "manual scaling" needs an activation of the "scale manual" button.

In text fields "4mA" and "20mA" the appropriate scaling values are entered, here from zero m<sup>3</sup>/h (4mA) to 300 m<sup>3</sup>/h (20mA).

With "Error Val" it is determined what is the output in case of an error at the analogue output.

- 2 mA Sensor error / System error
- 22 mA Sensor error / System error
- 4..20 Output according Namur (3.8mA – 20.5 mA)  
< 4mA to 3.8 mA Measuring range under range  
>20mA to 20.5 mA Measuring range exceeding

Inputs / changes to be confirmed with "OK" button. Return to main menu with "Back".

### 13.6.1.7 Settings Pulse / Alarm output of VA 5xx

External sensor → Settings → Sensor settings → C1 → arrow right (2.page) → More-Settings → Pulse / Alarm

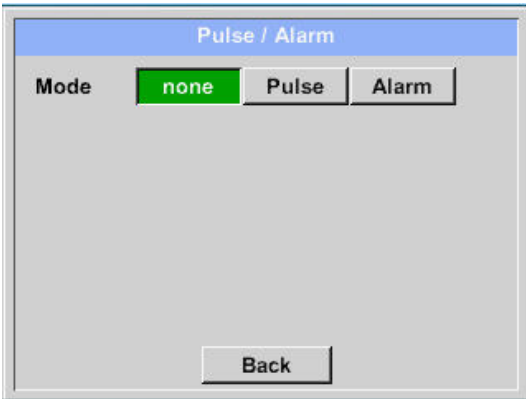

The pulse output of the VA 5xx could be set functionally as pulse output or alarm output.

Function to activate by pressing either the *“Pulse”* or *“Alarm”* button.

In case of no use, please select *“none”*.

Inputs / changes to be confirmed with *“OK”* button. Return to main menu with *“Back”*.

External sensor → Settings → Sensor settings → C1 → arrow right (2.page) → More-Settings → Pulse

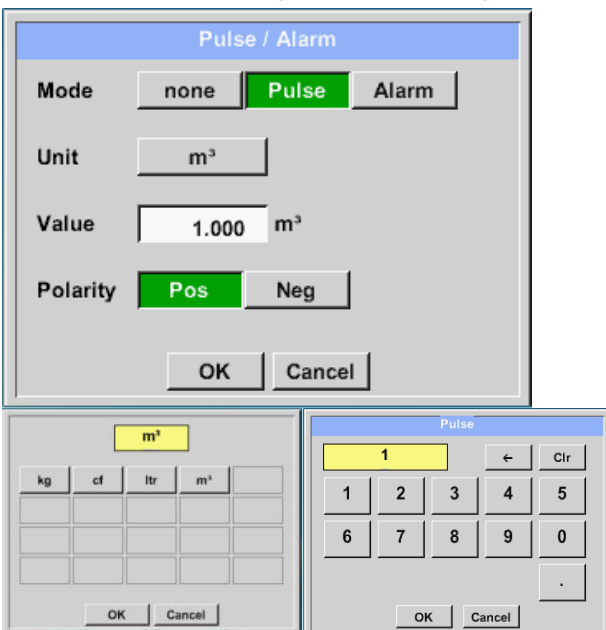

To set up the pulse first the unit and the measurement value have to be defined.

Unit selection by pressing *“unit”* button and choice one of the possible units *“kg”, “cf”, “ltr”* or *“m³”*).

Pulse weight setting by entering the text field *“Value”*.

Here with defined 1 pulse per m³ and with positive polarity.

With *„Polarity“* the switching state could be defined.

Pos. = 0 → 1 neg. 1 → 0

closed

open

**pos**

**neg**

Inputs / changes to be confirmed with *“OK”* button. Return to main menu with *“Back”*.

External sensor → Settings → Sensor settings → C1 → arrow right (2.page) → More-Settings → Alarm

The first screenshot shows the 'Pulse / Alarm' configuration screen. The 'Mode' is set to 'Alarm'. The 'Unit' is '°C'. The 'Value' is 55.000 with a tolerance of +/- 2.000. The 'Limit' is set to 'High'. The second screenshot shows the unit selection screen with '°C' selected. The third screenshot shows the numeric keypad with '55' entered.

In case of use the pulse output as alarm following definitions needs to be set:

Unit selection by pressing *“unit”* button and choice one of the possible units *“cfm”, “ltr/s”, “m<sup>3</sup>/h”, “m/s”, “°F”, “°C”, “kg/s” or “, “kg/min”*).

Alarm value setting by entering the text fields *“Value”*.

The limits *„High”* or *„Low”* defines when the alarm is activated, selecting by pressing the appropriate button

**High:** Value over limit

**Low:** Value under limit

Inputs / changes to be confirmed with *“OK”* button. Return to main menu with *“Back”*.

### 13.6.1.8 Settings ZeroPoint or Low Flow Cut off for VA 5xx

External sensor → Settings → Sensor settings → C1 → arrow right (2.page) → More-Settings → Zeropoint

The screenshot shows the 'Zero Setup' menu. At the top, it displays 'Actual Flow 2.045 m³/h'. Below this are two buttons: 'Adjustment' and 'Reset'. Underneath, the 'CutOff' is set to '0.000 m³/h'. At the bottom, there is a 'Back' button.

The screenshot shows the 'Zero Setup' menu with the 'CutOff' value changed to '10.000 m³/h'. All other elements, including 'Actual Flow 2.045 m³/h', the 'Adjustment' and 'Reset' buttons, and the 'Back' button, remain the same.

With these function following adjustments could be done.

#### Zeropoint:

When, without flow, the installed sensor shows already a flow value of  $> 0 \text{ m}^3/\text{h}$  herewith the zero point of the characteristic could be reset. Press the "Adjustment" key and confirm with "OK"

#### Cutoff:

With the low-flow cut off activated, the flow below the defined "LowFlow Cut off" value will be displayed as  $0 \text{ m}^3/\text{h}$  and not added to the consumption counter.

For inserting low flow cutoff value activate the text field "CutOff" and insert the required value, here 10.

With the "Reset" button all entries could be set back to zero.

Inputs / changes to be confirmed with "OK" button. Return to main menu with "Back".

## 13.7 Type Modbus

### 13.7.1 Selection and activation of Sensor-Type Modbus

**First Step: First step:** choose an unused sensor channel

External sensor → Settings → Sensor settings → C1

**Second step:** choose type Modbus

External sensor → Settings → Sensor settings → C1 → Type description field → Modbus

**Third step:** confirm with *OK*.

External sensor → Settings → Sensor settings → C1 → arrow right (2.page) → Va → use

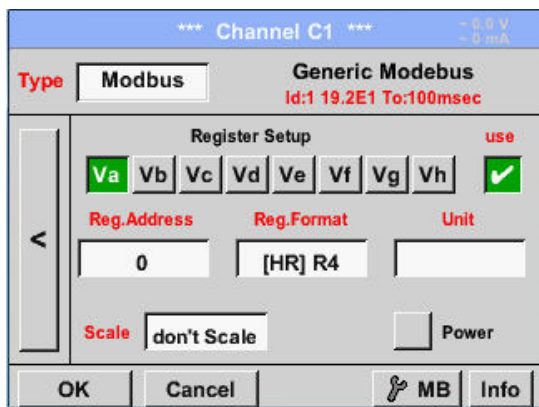

Via Modbus, it is possible to read out up to 8 Register-Values (from Input or Holding Register) of the sensor.

Selection by the Register Tabs *Va –Vh* and activation by pressing of the corresponding *Use* button.

#### 13.7.1.1 Modbus Settings

External sensor → Settings → Sensor settings → C1 → arrow right (2.page) → Modbus Settings → ID-text field

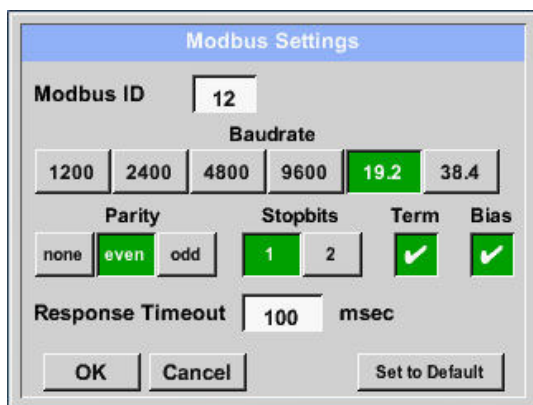

Please insert here the specified *Modbus ID* of the sensor, allowed values are *1 -247*, (e.g. here *Modbus ID = 12*)

For setting the Modbus ID on the sensor, please see sensor-datasheet.

In addition in the menu are the serial transmission settings *Baudrate*, *Stopbit*, *Paritybit* and *Timeout* time to define.

In case that the ILD 510 is the end of the RS485 bus system with activating *Term-* & *Bias-* button the required termination and biasing could be activated.

Confirmation by pressing *OK* button.

For resetting to the default values please press *Set to Default*.



External sensor → Settings → Sensor settings → C1 → Reg. Address description field

The measurement values are kept in the registers of the sensor and can be addressed via Modbus and read by the PI 500

This requires setting the desired register addresses in the ILD 510

Entering the register / data address is here in decimal with 0-65535.

### Important:

Required is the correct *register-address*.

It should be noted that the register-number could be different to the register-address (Offset). For this, please consult the sensor data sheet.

External sensor → Settings → Sensor settings → C1 → Reg. Format description field

With the buttons *Input Register* and *Holding Register* the corresponding Modbus-register type will be selected.

The number format and transmission order of each value needs to be defined by *Data Type* and *Byte Order*. Both have to be applied in correct combination.

### Supported Data types:

<b>Data Type:</b>	UI1(8b) = unsigned Integer	=>	0	-	255
	I1 (8b) = signed integer	=>	-128	-	127
	UI2 (16b) = unsigned Integer	=>	0	-	65535
	I2 (16b) = signed integer	=>	-32768	-	32767
	UI4 (32b) = unsigned Integer	=>	0	-	4294967295
	I4 (32b) = signed integer	=>	-2147483648	-	2147483647
	R4 (32b) = floating point number				

### Byte Order:

The size of each Modbus-register is 2 Byte. For a 32 bit value two Modbus-Register will be read out by the ILD510. Accordingly for a 16bit Value only one register is read.

In the Modbus Specification, the sequence of the transmitted bytes is not defined clearly. To cover all possible cases, the byte sequence in the ILD 510 is adjustable and must adapted to the respective sensor. Please consult here for the sensor datasheet.

e.g.: High byte before Low Byte, High Word before Low Word etc.

Therefore, the settings have to be made in accordance to the sensor data sheet.

**Example:**

Holding Register - UI1(8b) - Value: 18

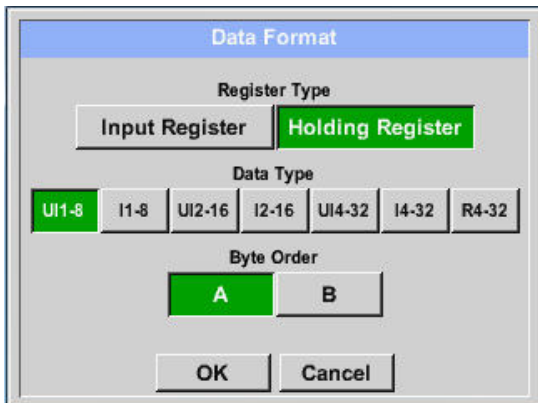

Selection Register Type *Holding Register*,  
Data Type *UI(8b)* und Byte Order *A / B*

	HByte	LByte
18 =>	00	12
Data Order	1. Byte	2. Byte
A	00	12
B	12	00

Holding Register – UI4(32) - Value: 29235175522 → AE41 5652

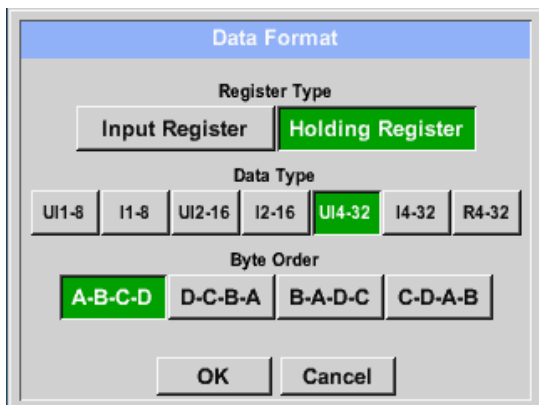

Selection Register Type *Holding Register*,  
Data Type *UI(32b)* und Byte Order *A-B-C-D*

	HWord		LWord	
	HByte	LByte	HByte	LByte
29235175522 =>	AE	41	56	52
Data Order	1.Byte	2.Byte	3.byte	4.Byte
A-B-C-D	AE	41	56	52
D-C-B-A	52	56	41	AE
B-A-D-C	41	AE	52	56
C-D-A-B	56	52	AE	41

External sensor → Settings → Sensor settings → C1 → Unit- description field

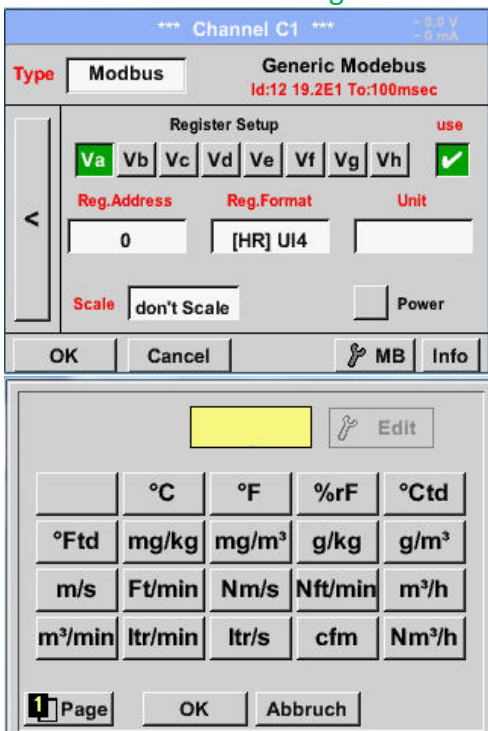

By pressing the description field *Unit* , the list with the available units appear

Please select the unit by pressing the respective button e.g. *m³/h*.

For validation of the unit, please push the button *OK*

To move through the list please press the button *Page*.

In case the unit is **not** available, it is possible to create a user defined unit.

Therefore, please select one of the *User\_X* buttons.

External sensor → Settings → Sensor settings → C1 → Scale- description field

The use of this factor allows adapting the output value by the same.

By default or value = 0 no scaling is applied and displayed in the field is *don't scale*

External sensor → Settings → Sensor settings → C1 → OK

By pressing the *OK* button, the inputs are confirmed and stored.

### 13.8 Data logger Settings

External sensor → Settings → Logger settings



In the top row you can select the predefined *Time intervals* 1, 2, 5, 10, 15, 30, 60 and 120 seconds for recording.

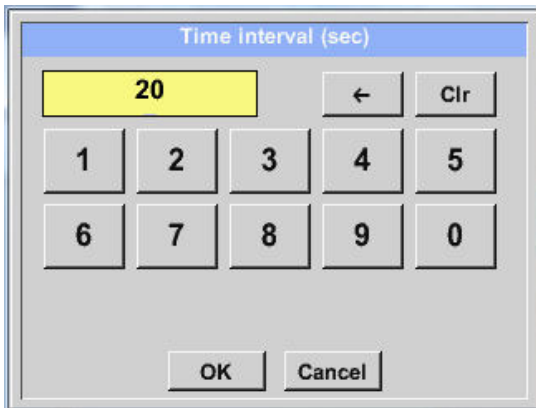

A different, individual *Time interval* can be entered in the highlighted white description field right at the head, where the currently set *Time interval* is always displayed.

**Remark:**  
The largest possible *Time interval* is 300 seconds.

**Remark:**

If more than 12 measurement data are recorded at the same time, the smallest possible time interval of the data logger is 2 seconds.

In addition, if more than 25 measurement data are recorded at the same time, the smallest possible time interval of the data logger is 5 seconds.

External sensor → Settings → Logger settings → force new Record File button

or

External sensor → Settings → Logger settings → force new Record File button → Comment description field

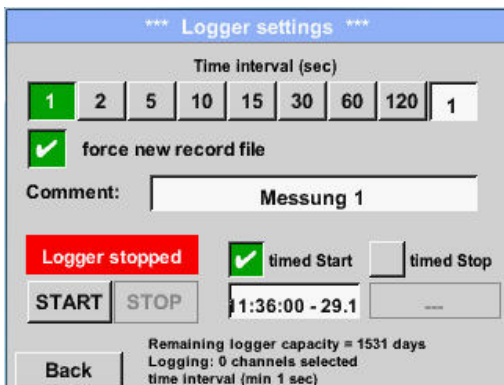
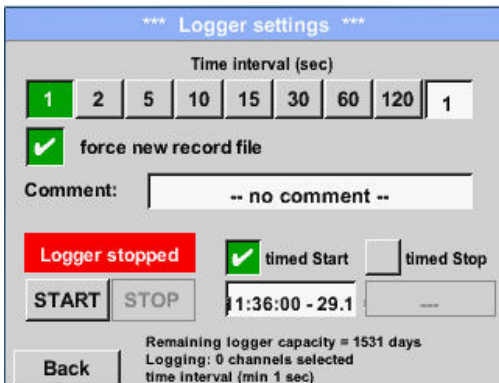

A new recording file will be created by pushing the *force new record file* button and a name or comment can be entered by the choice of the *Comment* description field.

**Important:**

If a new recording file should be created, the *force new record file* button must be activated.

Otherwise, the last applied recording file is used.

Main menu → Settings → Logger settings → timed Start button

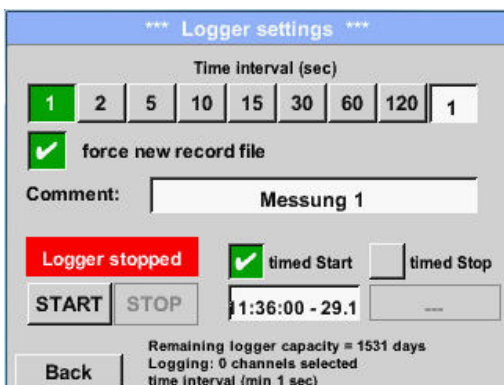

By pushing the *timed Start* button and then the date/time description field below, the date and the start time can be set for a data logger recording.

**Remark:**

If the start time is activated, it will automatically be set at the current time plus a minute.

External sensor → Settings → Logger settings → timed Stop button

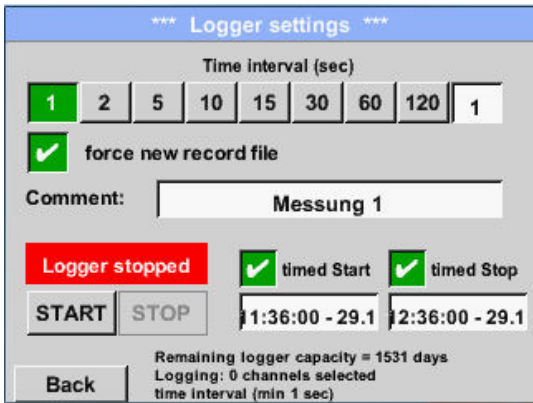

By pushing the *timed Stop* button and then the date/time description field below, the date and the stop time can be set for a data logger recording.

**Remark:**

If the stop time activated, it will automatically be set to the current time plus an hour.

External sensor → Settings → Logger settings → timed Start button/timed Stop button  
→ Date/Time description field

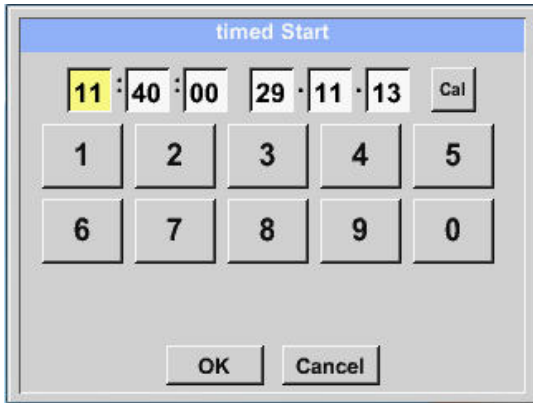

After pushing the *date/time description field* a window will appear where the yellow marked area of the time or date can always be set and changed.

External sensor → Settings → Logger settings → timed Start button/timed Stop button  
 → Date/Time description field → Cal button

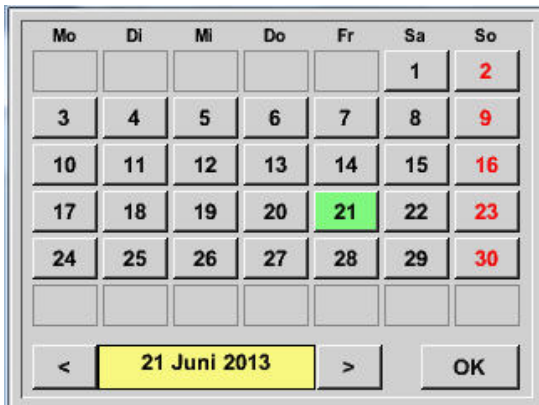

With the *Cal* button the desired date can be easily select from the calendar.

External sensor → Settings → Logger settings → Start button

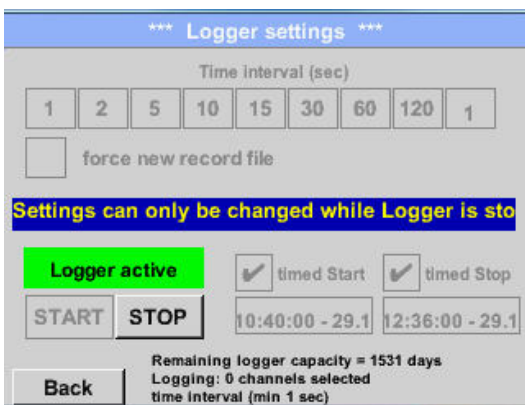

After the start and stop time activation and the created settings, the *Start* button will be pushed and the data logger is armed.

The data logger starts the recording at the set time!

External sensor → Settings → Logger settings → Start button/Stop button

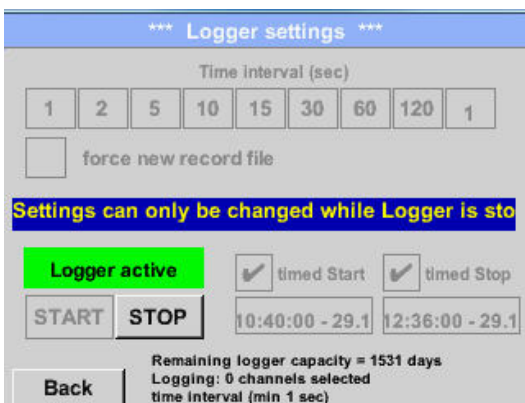

The data logger can be started without activated time settings, use the *Start* and *Stop* buttons for activate and disable.

Left below there will be shown how many values are recorded and how long there still can be recorded.

**Remark:**  
 The settings cannot be changed, if the data logger runs.

**Important:**

If a new recording file should be created, the *force new record file* button must be activated. Otherwise, the last applied recording file is used.

## 14 Scope of delivery

ILD 500 is available either as a single unit or in a set. The set contains all the components and accessories that are protected in a rugged and shock-resistant transport case.



The following table lists the components with their order numbers.

Description	Order No.
<b>Set ILD 500 consisting of:</b>	<b>0601 0105</b>
ILD 500 leak detector with acoustic trumpet, and integrated camera, 100 leak tags for marking the leakages on site	0560 0105
Sound-proof headset	0554 0104
Focus tube with focus tip	0530 0104
Battery charger(AC adapter plug)	0554 0009
Transportation case	0554 0106
Helix cable for connecting the ultrasonic sound sensor	020 001 402
Gooseneck for leak detection in hard-to-reach areas (optional)	0530 0105
Parabolic mirror for leak detection at long distances (optional)	0530 0106

## 15 Appendix

In the appendix on the following pages you will find the Declaration of Conformity for the electromagnetic compatibility and the Test Report of the Li-ion batteries used.







报告编号(Report ID): H11133012221D~1

# 锂电池UN38.3测试报告

## Lithium Battery UN38.3 Test Report

样品名称 (Sample Description)	Lithium-ion Battery 238700
委托单位 (Applicant)	Jauch Quartz GmbH-Batteries
生产单位 (Manufacturer)	Jauch Quartz GmbH-Batteries



**PONY 谱尼测试**  
Pony Testing International Group  
[www.ponytest.com](http://www.ponytest.com)

No.: H11133012221D  
Code: ssak93kqv



Pony Testing International Group

## I、SAMPLE DESCRIPTION

Sample Name	Lithium-ion Battery		Battery Type	238700	
Client	Jauch Quartz GmbH-Batteries				
Manufacturer	Jauch Quartz GmbH-Batteries				
Nominal Voltage	7.2V	Rated Capacity	2600mAh	Limited Charge Voltage	8.56±0.025V
Charge Current	1250mA	Maximum Continuous Charge Current	2600mA	End Charge Current	100mA
Cut-off Voltage	5.5V	Maximum Discharge Current	5200mA	Use	---
Cells Number	2PCS	Cell Model	18650	Rated Capacity	2600mAh
Manufacturer of cell	Samsung SDI Co., Ltd				
Chemical component	Li-Ion				
Client date	2013-11-12		Finished date	2013-12-02	

## II、REFERENCE METHOD

《United Nations Recommendations On The Transport Of Dangerous Goods, Manual Of Tests And Criteria》(ST/SG/AC.10/11/Rev.5/Amend.1).

## III、TEST ITEM

- |                        |                           |
|------------------------|---------------------------|
| 1. Altitude simulation | 5. External short circuit |
| 2. Thermal test        | 6. Impact                 |
| 3. Vibration           | 7. Overcharge             |
| 4. Shock               | 8. Forced discharge       |

## IV、CONCLUSION

ITEM	SAMPLE NUMBER	STANDARD	CONCLUSION
Altitude simulation	N1~N4 C1~C4	UN38.3	PASS
Thermal test			PASS
Vibration			PASS
Shock			PASS
External short circuit			PASS
Impact	N9~N13		PASS
Overcharge	N5~N8 C5~C8		PASS
Forced discharge	N14~N23 C9~C18		PASS

The submitted battery and component cell were complied with the UN Manual of Tests and Criteria, Part III, sub-section 38.3.

Prepared by: *Pony Yan Kun*Checked by: *chengpeng*Approved by: *Pigou*

Approval Date: December 2, 2013

**PONY 谱尼测试**  
Pony Testing International Group

www.ponytest.com ☎Hotline 400-819-5688

Add: 北京市海淀区东升路19-3号嘉智大厦 Tel: (010) 82618118	Add: 上海浦东新区桂平路880号25号楼4层 Tel: (021) 64851999	Add: 深圳南山区西丽镇中伙工业区福源2号 Tel: (0755) 28850900	Add: 青岛崂山区株洲路199号6层 Tel: (0132) 89736600
Add: 天津滨海新区仕御路嘉里大厦10层 Tel: (022) 27549798	Add: 宁波高新区新南路150号二第6号第4层 Tel: (0578) 87734499	Add: 广州海珠区黄村路189号海珠科技园7号楼7层 Tel: (020) 89224318	

