

Test gauge, stainless steel Standard version, class 0.6, NS 160 [6"] Models 332.50, 333.50

WIKA data sheet PM 03.06



for further approvals
see page 3

Applications

- With liquid-filled case for applications with high dynamic pressure loads or vibrations
- For gaseous and liquid aggressive media that are not highly viscous or crystallising, also in aggressive environments
- Precision measurement in laboratories
- High-accuracy pressure measurement
- Testing of industrial type pressure gauges

Special features

- Completely from stainless steel
- Knife edge pointer for optimal accuracy of reading
- Wear-resistant precision movement from stainless steel
- Scale ranges from 0 ... 0.6 to 0 ... 1,600 bar [0 ... 10 psi to 0 ... 20,000 psi]



Test gauge, stainless steel, model 332.50

Description

The model 33x.50 high-quality test gauge has been specifically designed for the measurement of pressures with high accuracy. With its accuracy class of 0.6, the Bourdon tube pressure gauge is suitable for testing industrial type pressure gauges or for precision measurement in laboratories. Optionally, an accuracy class of 0.25 is available for pressures ≤ 400 bar [6,000 psi].

For the respective measuring requirement, a scale range between 0 ... 0.6 and 0 ... 1,600 bar [0 ... 10 psi and 0 ... 20,000 psi] can be selected.

The optimal readability of the instrument, with a nominal size of 160 mm [6"], is achieved via a knife edge pointer and a dial with fine divisions. In addition, a mirror scale can be chosen to avoid the parallax error.

The wear-resistant precision movement, the wetted parts and the case are made from high-grade stainless steel. The instrument meets the requirements of the international industry standard EN 837-1 for Bourdon tube pressure gauges and has a blow-out device with blow-out plug on the back of the case. In the event of a failure, overpressure can escape there and the operator is protected at the front side. For harsh operating conditions (e.g. vibrations), the instruments are also available with an optional liquid filling.







On request, a calibration certificate will be provided for this instrument.

Safe storage and transport is ensured by a transport case (accessory).

Specifications

Models 332.50 and 333.50	
Standard	EN 837-1 See Technical Information IN 00.05 for information on "Selection, installation, handling and operation of pressure gauges".
Nominal size (NS)	Ø 160 mm [6"]
Accuracy class	<ul style="list-style-type: none"> ■ 0.6 ■ 0.25 (selectable for scale ranges ≤ 400 bar) ■ Grade 3A per ASME B40.100 (selectable for scale ranges ≤ 400 bar)
Scale ranges	0 ... 0.6 bar to 0 ... 1,600 bar [0 ... 10 psi to 0 ... 20,000 psi] other units (e.g. psi, kPa) available or all other equivalent vacuum or combined pressure and vacuum ranges
Scale	<ul style="list-style-type: none"> ■ Single scale ■ Mirror band scale
Zero point setting	<ul style="list-style-type: none"> ■ Without ■ From outside through adjustable dial
Pressure limitation	
Steady	Full scale value
Fluctuating	0.9 x full scale value
Short time	1.3 x full scale value
Connection location	<ul style="list-style-type: none"> ■ Lower mount (radial) ■ Lower back mount
Process connection	G ½ B Others on request
Permissible temperature	
Medium	<ul style="list-style-type: none"> ■ +200 °C [+392 °F] maximum with unfilled instruments ■ +100 °C [+212 °F] maximum with filled instruments (model 333.50)
Ambient	<ul style="list-style-type: none"> ■ -40 ... +60 °C [-40 ... +140 °F] with unfilled instruments ■ -20 ... +60 °C [-4 ... +140 °F] with instruments with glycerine filling (model 333.50)
Temperature effect	When the temperature of the measuring system deviates from the reference temperature (+20 °C): max. ±0.4 %/10 K of full scale value
Case filling	<ul style="list-style-type: none"> ■ Without ■ Glycerine
Wetted materials	
Process connection	Stainless steel 316L
Pressure element	Stainless steel 316L < 100 bar: Copper alloy, C-type ≥ 100 bar: Stainless steel 316L, helical type ≥ 1,000 bar: Ni-Fe alloy, helical type
Non-wetted materials	
Case	Stainless steel Safety level "S1" per EN 837: With blow-out device in case back Scale ranges ≤ 0 ... 10 bar with compensating valve to vent case
Ring	<ul style="list-style-type: none"> ■ Bayonet ring, stainless steel ■ Triangular profile ring, polished stainless steel, with clamp
Movement	Stainless steel
Dial	Aluminium, white, black lettering
Pointer	Knife edge pointer, aluminium, black
Window	Laminated safety glass
Ingress protection per IEC/EN 60529	IP65
Adjustment medium	<ul style="list-style-type: none"> ■ Liquid for scale ranges > 25 bar; gas for scale ranges ≤ 25 bar ■ Gas for all scale ranges

Approvals

Logo	Description	Country
	EU declaration of conformity Pressure equipment directive, PS > 200 bar; module A, pressure accessory	European Union
	GOST (option) Metrology, measurement technology	Russia
	KazInMetr (option) Metrology, measurement technology	Kazakhstan
-	MTSCHS (option) Permission for commissioning	Kazakhstan
	BelGIM (option) Metrology, measurement technology	Belarus
	UkrSEPRO (option) Metrology, measurement technology	Ukraine
	Uzstandard (option) Metrology, measurement technology	Uzbekistan
-	CPA (option) Metrology, measurement technology	China
-	CRN Safety (e.g. electr. safety, overpressure, ...) For scale ranges ≤ 1,000 bar	Canada

Certificates (option)

- 2.2 test report per EN 10204 (e.g. state-of-the-art manufacturing, material proof, indication accuracy)
- 3.1 inspection certificate per EN 10204 (e.g. material proof for wetted metal parts, indication accuracy)
- PCA calibration certificate, traceable and accredited in accordance with ISO/IEC 17025
- Calibration certificate by the national accreditation body, traceable and accredited in accordance with ISO/IEC 17025 on request

Approvals and certificates, see website

Accessories

- Sealings (model 910.17, see data sheet AC 09.08)
- Panel or surface mounting flange, stainless steel
- Transport case

Dimensions in mm [in]

Standard version

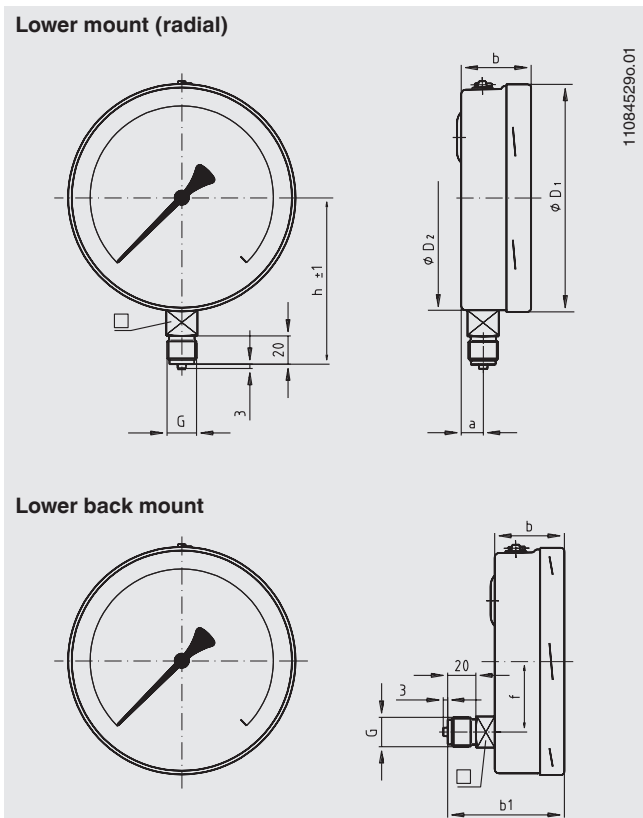

NS	Dimensions in mm [in]									Weight in kg [lbs]
	a	b	b1	D ₁	D ₂	f	G	h ±1	SW	
160	15.5 [0.61]	49.5 [1.949] ¹⁾	83 [3.268] ¹⁾	161 [6.339]	159 [6.26]	50 [1.969]	G ½ B	118 [4.646]	22	1.10 [2.947]

1) Plus 16 mm with scale ranges ≥ 100 bar

Process connection per EN 837-1 / 7.3

Ordering information

Model / Nominal size / Scale range / Process connection / Connection location / Options

© 03/2008 WIKA Alexander Wiegand SE & Co. KG, all rights reserved.
The specifications given in this document represent the state of engineering at the time of publishing.
We reserve the right to make modifications to the specifications and materials.