

Differential pressure gauge Cryo Gauge, copper alloy or stainless steel, NS 160 Models 712.15.160 and 732.15.160

WIKA data sheet PM 07.30



for further approvals see
page 4

Cryo Gauge

Applications

- Level measurements in closed tanks, particularly in cryotechnology
- Filter monitoring
- Pump monitoring and control
- For gaseous and liquid media that are not highly viscous or crystallising and have no suspended solids

Special features

- Differential pressure measuring ranges from 0 ... 40 mbar to 0 ... 4,000 mbar
- High working pressure (static pressure) of 50 bar
- Overpressure safety either side up to 50 bar
- Scalable measuring ranges (maximum turndown of 1 : 3.5)
- Compact valve manifold with working pressure indication (optional)

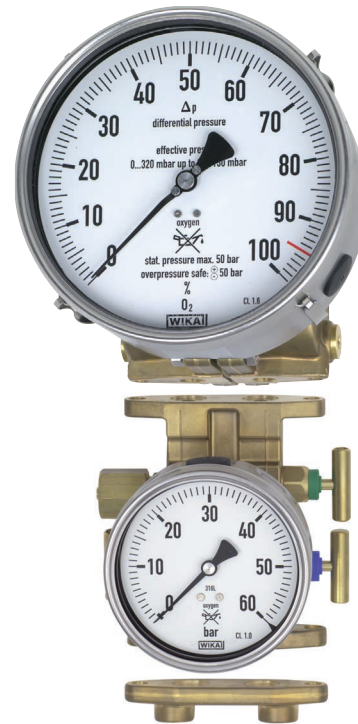

Fig. top: Differential pressure gauge model 712.15.160

Fig. centre: Option valve manifold with working pressure indication

Fig. bottom: Option adapter for flange mounting

Description

These high-quality differential pressure gauges are notable for their compact and robust design and are primarily used for level measurement on liquid gas tanks.

With 6 different measuring cells, all usual tank sizes in cryotechnology are covered. The large overlap in measuring ranges of the measuring cells enables the setting for gas types such as Ar, O₂, N₂ or CO₂ over the entire scale with 270 angular degrees. The span adjustment is accessible from outside and does not affect the zero point.

The mechanical display and the integrated transmitter with 4 ... 20 mA output signal (optional) are calibrated simultaneously and easily. An optional valve manifold for flange mounting makes the central level measurement and working pressure indication possible in the one instrument. Switch contacts for level and working pressure, as well as a transmitter for the working pressure can be retrofitted on-site.

The standard centre distance of 37 mm between the process connections can be adapted to a custom centre distance of 31 mm or 54 mm using adapters for flange mounting.

Specifications

Models 712.15.160 and 732.15.160	
Nominal size in mm	160
Accuracy class	2.5 Option: ■ 1.6 ■ 1.0
Scale ranges	Measuring cell 140 mbar: Setting range 0 ... 40 mbar to 0 ... 140 mbar Measuring cell 280 mbar: Setting range 0 ... 80 mbar to 0 ... 280 mbar Measuring cell 560 mbar: Setting range 0 ... 160 mbar to 0 ... 560 mbar Measuring cell 1,130 mbar: Setting range 0 ... 320 mbar to 0 ... 1,130 mbar Measuring cell 2,300 mbar: Setting range 0 ... 650 mbar to 0 ... 2,300 mbar Measuring cell 4,000 mbar: Setting range 0 ... 1,150 mbar to 0 ... 4,000 mbar
Scale	Single scale Option: Individual scale design
Zero point setting	By means of adjustable pointer
Overload safety and max. working pressure (static pressure)	Either side max. 50 bar
Connection location	Lower mount (radial)
Process connection	■ 2 x G ¼, female, centre distance 37 mm ■ 2 x ¼ NPT, female, centre distance 37 mm others on request Option: Adapter for process connection, see page 6
Wetted materials	
Measuring cell flanges	Model 712.15: Copper alloy CW614N (CuZn39Pb3) Model 732.15: Stainless steel 316L
Compression spring	Stainless steel 1.4310
Separating diaphragm	NBR
Transmission parts	Stainless steel 1.4301 and 1.4305
Non-wetted materials	
Case	Stainless steel
Bayonet ring	Stainless steel
Movement	Stainless steel
Dial	Aluminium, white
Pointer	Adjustable pointer, black aluminium
Window	Polycarbonate (PC)
Ingress protection per IEC/EN 60529	IP65
Mounting	According to affixed symbols ⊕ high pressure, ⊖ low pressure

Permissible temperature ranges

	Non-Ex version: Models 712.15.160 and 732.15.160 optionally with model 891.44 ¹⁾	Ex version: Models 712.15.160 and 732.15.160 with model 892.44 ¹⁾
Ambient	-40 ... +60 °C with oxygen -40 ... +80 °C	-40 ... +60 °C for temperature class T6 and T5 -40 ... +80 °C for temperature class T4
Medium	-40 ... +60 °C with oxygen -40 ... +80 °C	-40 ... +60 °C with oxygen -40 ... +60 °C for temperature class T6 and T5 -40 ... +80 °C for temperature class T4

1) Integrated transmitter electronics see page 7

Design and operating principle

Pressures p_1 and p_2 act on the media chambers \oplus and \ominus , which are separated by an elastic diaphragm (1).

The differential pressure ($\Delta p = p_1 - p_2$) leads to an axial deflection of the diaphragm against the measuring range spring (2).

The deflection, which is proportional to the differential pressure, is transmitted to the movement (5) in the indicating case (4) via a pressure-tight and low friction lever mechanism (3).

Overload safety is provided by metal bolsters (6) resting against the elastic diaphragm.

Illustration of the principle

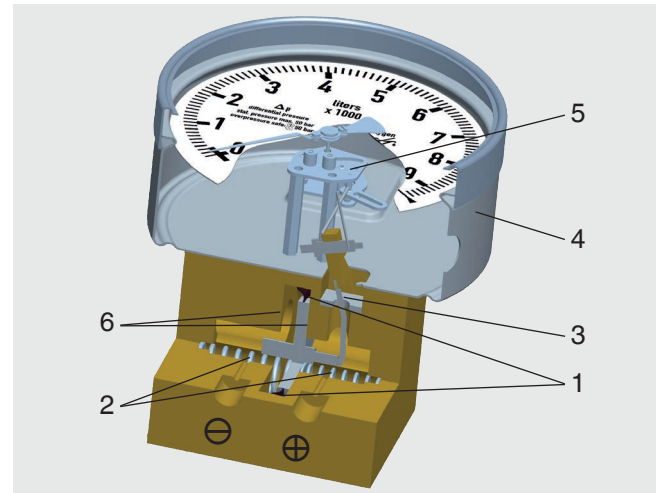

Span adjustment

The measuring span of the differential pressure gauge can, depending on the measuring cell, be adjusted within the setting range specified to the left. Ideally, this adjustment to the setting range should be made on a test bench, though it can also be carried out at the measuring point using a hand test pump.

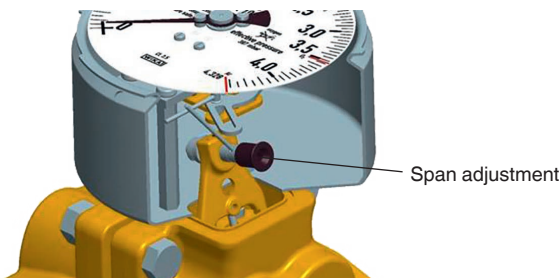







The span adjustment, situated at the 4 o'clock point on the case circumference, is accessible by removing the sealing cap. Pressurise the instrument with the required nominal pressure and, with a hexagon screwdriver (SW 3 mm) inserted into the funnel guide, adjust the pointer to the end value by turning it clockwise (smaller measuring range) or anti-clockwise (larger measuring range). If the instrument is equipped with a model 89x.44 transmitter, then this procedure will also adjust the output signal to the new measuring range. The instrument will then be fully adjusted to the required measuring range. After completing the adjustment the instrument should be re-sealed with the sealing cap.

Scale designs

The dials can be made to customer's requirements and also with multiple scales.

These can be printed with all usual units on them, e.g. kg, litre, m^3 , mmH_2O , $inchH_2O$, %, etc. Red marks for maximum fill level, customer logos and other custom printing are likewise possible. If desired, we can carry out the calculation for the tank fuel level from drawings of the tank geometry, and then make the appropriate scales.

Approvals

Logo	Description	Country
	EU declaration of conformity <ul style="list-style-type: none"> ■ EMC directive ■ Pressure equipment directive ■ ATEX directive (option) ¹⁾ Hazardous areas - Ex ia Gas [II 2G Ex ia IIC T6/T5/T4 Gb] 	European Union
	IECEx (option) ¹⁾ Hazardous areas - Ex ia Gas [Ex ia IIC T6/T5/T4 Gb]	International
	EAC (option) <ul style="list-style-type: none"> ■ EMC directive ■ Pressure equipment directive ■ Low voltage directive ■ Hazardous areas ¹⁾ 	Eurasian Economic Community
	GOST (option) Metrology, measurement technology	Russia
	KazInMetr (option) Metrology, measurement technology	Kazakhstan
-	MTSCHS (option) Permission for commissioning	Kazakhstan
	BelGIM (option) Metrology, measurement technology	Belarus
	Uzstandard (option) Metrology, measurement technology	Uzbekistan
-	CPA Metrology, measurement technology	China
-	CRN Safety (e.g. electr. safety, overpressure, ...)	Canada
	BAM Oxygen application	Germany

1) Only for instruments with integrated transmitter model 892.44

Certificates (option)

- 2.2 test report per EN 10204 (e.g. state-of-the-art manufacturing, indication accuracy)
- 3.1 inspection certificate per EN 10204 (e.g. indication accuracy)

Approvals and certificates, see website

Dimensions in mm

Models 712.15.160 and 732.15.160

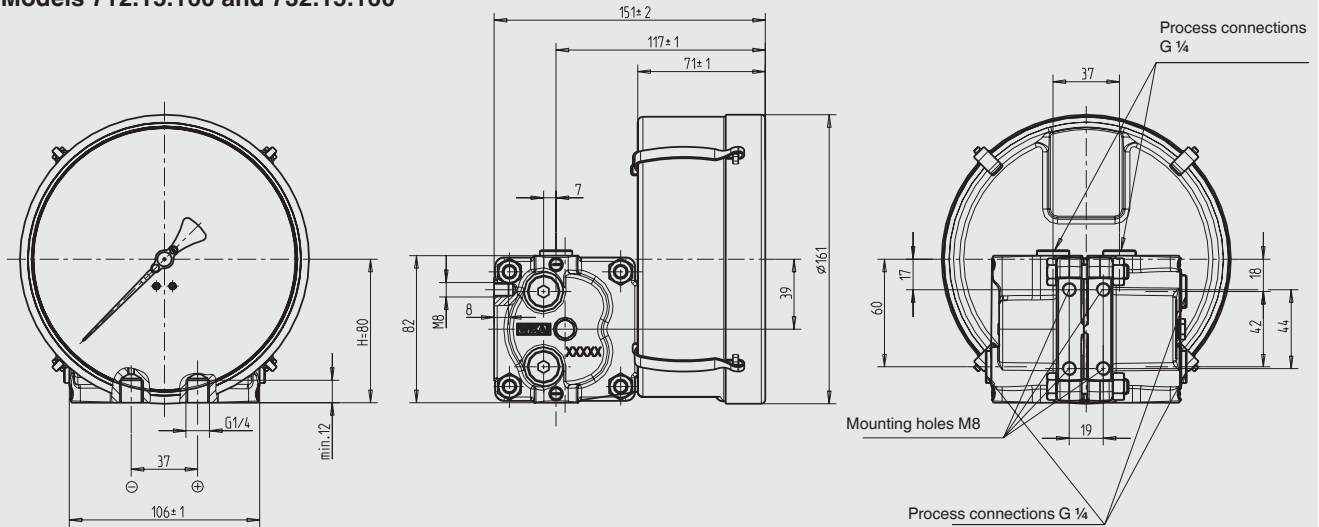

Drawing with optional mounted adapter (centre distance 54 mm)

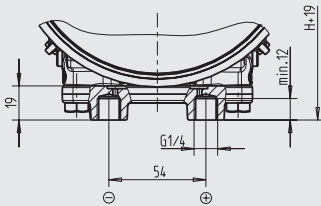

11224380.02

Option

Valve manifold (wetted) with working pressure indication

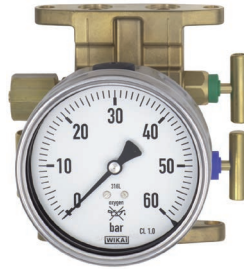

Specifications

Valves	2 x shut-off valve, 1 x pressure compensating valve
Test connection	M20 x 1.5 with sealing cap (DIN 16287-A)
Valve body	<ul style="list-style-type: none"> ■ Copper alloy CW614N (CuZn39Pb3) for model 712.15 ■ Stainless steel 316L for model 732.15
Spindle with conical nipple	<ul style="list-style-type: none"> ■ Copper alloy for model 712.15 ■ Stainless steel 316L for model 732.15
Packing/sealing	NBR/PTFE With the valve fully-opened, the spindle area is isolated from the process by a metallic seal, the packing is not loaded and the spindle thread is not in contact with the measured media.
Working pressure indication	<ul style="list-style-type: none"> ■ Bourdon tube pressure gauge, copper alloy; model 212.20.100; see data sheet PM 02.01 ■ Bourdon tube pressure gauge, stainless steel, model 232.50.100, see data sheet PM 02.02 ■ Bourdon tube pressure gauge, stainless steel, safety version; model 232.30.100; see data sheet PM 02.04

All parts necessary for installation are included in the scope of delivery:

- 4 x hexagon screws M8 x 16
- 2 x O-ring sealing

Option

Integrated transmitter electronics

Non-Ex version: Model 891.44

Ex version: Model 892.44

WIKA differential pressure gauges with an integrated model 89x.44 transmitter combine all the advantages of an on-site mechanical display with the demands modern industry makes for electrical signal transmission for the detection of measured values.

The transmitter electronics are integrated into the case of the level indicator. The measuring span (electrical output signal) is adjusted automatically with the mechanical display, i.e. the scale over 270 angular degrees corresponds to 4 ... 20 mA.

The output signal can be changed over to the desired gas type by rotating the optional BCD switch (accessible through a sealing cap on the left side of the case) using a screwdriver.



Specifications	Models 891.44 and 892.44 (Ex version)
Output signal	4 ... 20 mA, 2-wire
Supply voltage U_B	Non-Ex version, model 891.44: DC 12 V < U_B ≤ 30 V Ex version, model 892.44: DC 14 V < U_B ≤ 30 V
Influence of supply voltage	≤ 0.1 % of full scale/10 V
Permissible residual ripple	≤ 10 % ss
Permissible max. load R_A	$R_A \leq (U_B - 12 \text{ V})/0.02 \text{ A}$ with R_A in Ω and U_B in V, however max. 600 Ω
Effect of load	≤ 0.1 % of full scale
Adjustability	
Zero point, electrical	Adjustment of the zero point through brief bridging of terminals 5 and 6 or using the "scale selection switch" option, selectable via button ¹⁾
Scale selection	4 scales selectable via BCD switch
Linear error	≤ 1.0 % of span (terminal method)
Compensated temperature range	-40 ... +80 °C
Temperature coefficients in the compensated temperature range	
Mean TC zero point	≤ 0.3 % of span/10 K
Mean TC span	≤ 0.3 % of span/10 K
Electrical connection	Cable socket PA 6, black Per VDE 0110 insulation group C/250 V Cable gland M20 x 1.5 Strain relief 6 screw terminals + PE for conductor cross-section 2.5 mm ²
Electrical safety	Protection against reverse polarity and overvoltage
Ingress protection	IP65 per EN/IEC 60529
Safety-related maximum values for Ex version, model 892.44	
Supply voltage U_i	DC 14 ... 30 V
Short-circuit current I_i	≤ 100 mA
Power P_i	≤ 720 mW
Internal capacitance C_i	≤ 17.5 nF
Internal inductance L_i	negligible
Designation of connection terminals, 2-wire	<div style="display: flex; align-items: center;"> <div style="flex: 1;"> </div> <div style="flex: 1; padding-left: 20px;"> <p>Terminals 3, 4, 5 and 6: For internal use only</p> <p>Connection ① must not be used for equipotential bonding. The instrument must be incorporated in the equipotential bonding via the process connection.</p> </div> </div>

1) Only possible within 30 seconds of connecting the supply voltage

Option

Pressure sensor for working pressure

Non-Ex version: Model A-10

Ex version: Model IS-3

Pressure sensor for working pressure



The pressure sensors for the working pressure are screwed into the minus media chamber on the left side and can also be mounted on-site, if required.

Process connection, pressure sensor: G 1/4 male



Specifications	A-10	IS-3
Data sheet	PE 81.60	PE 81.58
Ex version	No	Yes, intrinsically safe
Measuring ranges	0 ... 2.5 bar to 0 ... 60 bar	0 ... 2.5 bar to 0 ... 60 bar
Outputs	4 ... 20 mA	4 ... 20 mA (repeater power supply required)
Medium temperature	-30 ... +100 °C	-20 ... +60 °C
Ambient temperature	-30 ... +80 °C	-20 ... +60 °C
Wetted parts	Stainless steel	Stainless steel
Supply voltage U_B	DC 10 V < U_B ≤ 30 V	DC 10 V < U_B ≤ 30 V
Permissible max. load R_A	$R_A \leq (U_B - 8 \text{ V}) / 0.02 \text{ A}$	$R_A \leq (U_B - 10 \text{ V}) / 0.02 \text{ A}$
Accuracy, best fit straight line, BFSL	≤ 0.5 % of span	≤ 0.2 % of span
Compensated temperature range	0 ... +80 °C	0 ... +60 °C
Designation of connection terminals, 2-wire		

For dimensions see page 10

Option

Switch contacts

Single and double magnetic snap-action contact, model 828¹⁾ for level indicator and/or working pressure.

A modular system of electromechanical switch contacts with plug connection, also suitable for retrofitting on-site, can be fitted both to the level indicator and to the working pressure indicator. The add-on unit can be fitted in just a few minutes to any pointer measuring instrument. The connection to the actual value pointer is made by means of a special yoke so that a carrier pin at the pointer itself is not needed.

The set value pointer of the installed switch contacts are adjusted, from the outside, to the value at which the switching operation is to take place, using the adjustment lock with a separate or integral key.

1) For specifications and further information, see data sheet AC 08.01 under the identically constructed magnetic snap-action contact, model 821

Switching functions

Index 1 behind the contact model no. means: **Contact makes** the circuit when the set point is exceeded.

Index 2 behind the contact model no. means: **Contact breaks** the circuit when the set point is exceeded.

Index 3 behind the contact model no. means: When the set value is exceeded, one circuit breaks and one circuit makes **simultaneously** (change-over contact).

The switching functions are based on a clockwise rotational motion of the instrument pointer.

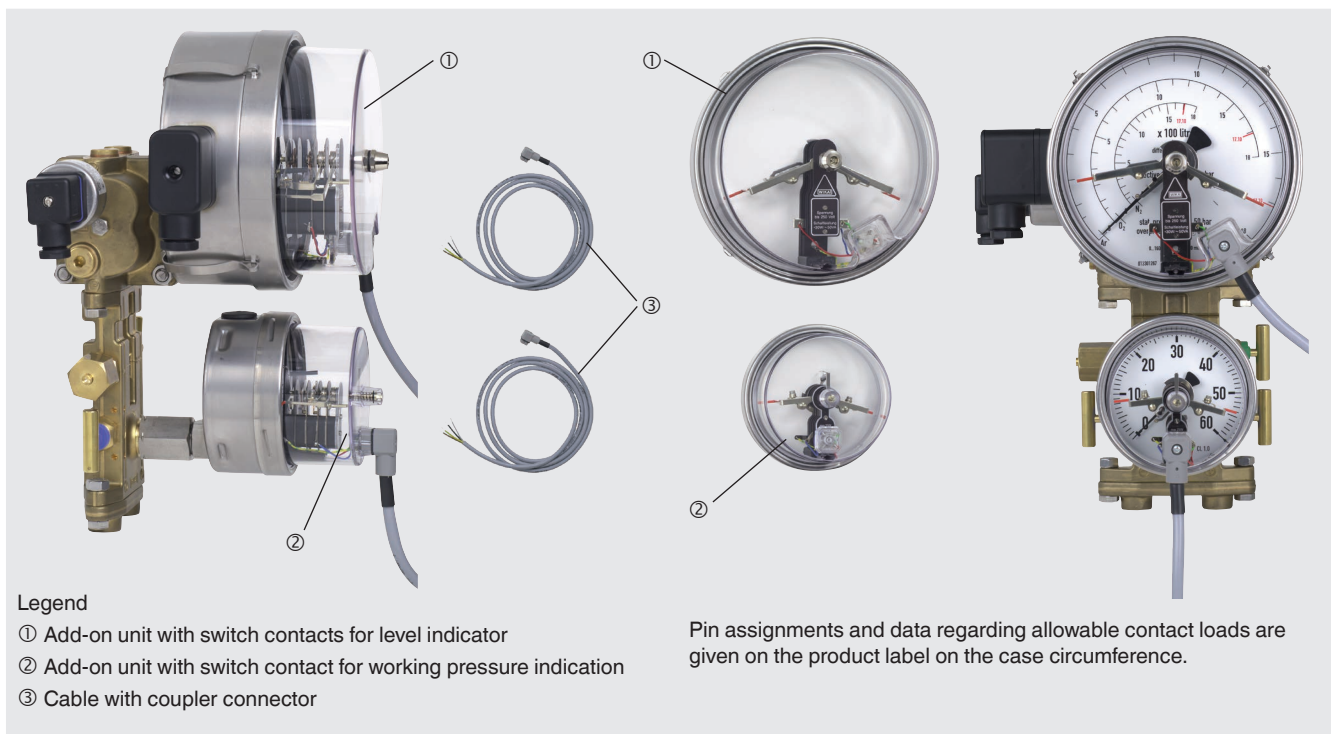

All parts necessary for installation are included in the scope of delivery:

- Cable with coupler connector
- Centring screw M3 x 20
- Sealing

