

Bourdon tube pressure gauge with electrical output signal Stainless steel, safety version, NS 63 [2 ½"] Model PGT23.063

WIKA data sheet PV 12.03



**UK
CA**

for further approvals,
see page 7

intelliGAUGE®

Applications

- Acquisition and display of process values
- Output signal 4 ... 20 mA for the transmission of process values to the control room
- Easy-to-read, analogue on-site indication needing no external power
- Safety-related applications

Special features

- No configuration necessary due to "plug-and-play"
- Measuring ranges of up to 0 ... 1,000 bar or 0 ... 15,000 psi
- Easy-to-read analogue indication with nominal size 63
- Safety version with solid baffle wall (Solidfront) designed in compliance with the requirements of EN 837-1 and ASME B40.100
- Patents and property rights, e.g. US 8030990, DE 112007000980, CN 101438333



intelliGAUGE, model PGT23.063

Description

Wherever the process pressure has to be indicated locally under limited space conditions and, at the same time, a signal transmission to the central control or remote centre is desired, the model PGT23.063 intelliGAUGE® can be used.

Through the combination of a mechanical measuring system and precise electronic signal processing, the process pressure can be read securely, even if the power supply is lost.

WIKA manufactures and qualifies the pressure gauge in accordance with the standards EN 837-1 and ASME B40.100. This safety version is made up of a non-splintering window, a solid baffle wall between measuring system and dial and a blow-out back. In the event of a failure, the operator is protected at the front side, as media or components can only be ejected via the back of the case.

The all welded and robust Bourdon tube measuring system produces a pointer rotation proportional to the pressure. An electronic angle encoder, proven in safety-critical automotive applications, determines the position of the pointer shaft – it is a non-contact sensor and therefore completely free from wear and friction. From this, the electrical output signal proportional to the pressure, 4 ... 20 mA, is produced.

The electronic WIKA sensor, integrated into the high-quality pressure gauge, combines the advantages of electrical signal transmission with the advantages of a local mechanical display.

The measuring span (electrical output signal) is adjusted automatically along with the mechanical display, i.e. the scale over the full measuring range corresponds to 4 ... 20 mA.

Specifications

Basic information	
Standard	<ul style="list-style-type: none"> ■ EN 837-1 ■ ASME B40.100 <p>For information on the "Selection, installation, handling and operation of pressure gauges", see technical information IN 00.05.</p>
Further version	<ul style="list-style-type: none"> ■ Oil- and grease-free ■ For oxygen, oil- and grease-free
Nominal size (NS)	Ø 63 mm [2 ½"]
Connection location	Lower mount
Window	<ul style="list-style-type: none"> ■ Polycarbonate ■ Laminated safety glass
Case	
Design	Safety level "S3" per EN 837-1 With solid baffle wall and blow-out back Measuring ranges ≤ 0 ... 16 bar [≤ 0 ... 300 psi] with compensating valve to vent and reseal case
Material	Stainless steel 1.4301 (304)
Ring	Bayonet ring, stainless steel
Mounting	<ul style="list-style-type: none"> ■ Without ■ Surface mounting lugs on the back, stainless steel ■ Panel mounting flange, polished stainless steel
Case filling	<ul style="list-style-type: none"> ■ Without ■ Silicone oil¹⁾
Movement	Stainless steel

1) Only in connection with miniature connector M8 x 1. For electrical connection see table on page 5.

Measuring element	
Type of measuring element	Bourdon tube, C-type or helical type
Material	Stainless steel 1.4404 (316L)
Leak tightness	Helium tested, leakage rate: < 1 · 10 ⁻⁶ mbar l/s

Accuracy specifications	
Accuracy of mechanical display	
EN 837-1	Class 1.6
ASME B40.100	±2 % ±1 % ±2 % of measuring span (grade A)
Accuracy of output signal	
Accuracy	±1.6 % of measuring span
Linearity error	≤ 1.6 % of measuring span (terminal method) ¹⁾
Influence of auxiliary power	< 0.1 % of FS/10 V
Influence of load	≤ 0.1 % of FS
Long-term stability	< 0.5 % of FS/a
Temperature error	On deviation from the reference conditions at the measuring system: ≤ ±0.8 % per 10 °C [≤ ±0.8 % per 18 °F] of full scale value
Reference conditions	
Ambient temperature	+20 °C [68 °F]

1) For technical reasons, up to the first scale marking, the measured value can lie outside of the class accuracy

Measuring ranges

bar	
0.2 ... 1	0 ... 40
0 ... 1	0 ... 60
0 ... 1.6	0 ... 70
0 ... 2	0 ... 100
0 ... 2.5	0 ... 140
0 ... 4	0 ... 160
0 ... 6	0 ... 200
0 ... 7	0 ... 250
0 ... 10	0 ... 315
0 ... 14	0 ... 400
0 ... 16	0 ... 600
0 ... 20	0 ... 700
0 ... 25	0 ... 1,000
0 ... 30	

kPa	
0 ... 100	0 ... 4,000
0 ... 160	0 ... 6,000
0 ... 200	0 ... 7,000
0 ... 250	0 ... 10,000
0 ... 300	0 ... 14,000
0 ... 400	0 ... 16,000
0 ... 600	0 ... 20,000
0 ... 700	0 ... 25,000
0 ... 1,000	0 ... 31,500
0 ... 1,400	0 ... 40,000
0 ... 1,600	0 ... 60,000
0 ... 2,500	0 ... 70,000
0 ... 3,000	0 ... 100,000

psi	
3 ... 15	0 ... 600
0 ... 15	0 ... 800
0 ... 30	0 ... 1,000
0 ... 60	0 ... 1,500
0 ... 100	0 ... 2,000
0 ... 150	0 ... 3,000
0 ... 160	0 ... 4,000
0 ... 200	0 ... 5,000
0 ... 250	0 ... 6,000
0 ... 300	0 ... 7,500
0 ... 400	0 ... 10,000
0 ... 500	0 ... 15,000

kg/cm ²	
0 ... 1	0 ... 40
0 ... 1.6	0 ... 60
0 ... 2	0 ... 70
0 ... 2.5	0 ... 100
0 ... 4	0 ... 140
0 ... 6	0 ... 160
0 ... 7	0 ... 200
0 ... 10	0 ... 250
0 ... 14	0 ... 315
0 ... 16	0 ... 400
0 ... 20	0 ... 600
0 ... 25	0 ... 700
0 ... 30	0 ... 1,000

MPa	
0 ... 0.1	0 ... 4
0 ... 0.16	0 ... 6
0 ... 0.2	0 ... 7
0 ... 0.25	0 ... 10
0 ... 0.4	0 ... 14
0 ... 0.6	0 ... 16
0 ... 0.7	0 ... 20
0 ... 1	0 ... 25
0 ... 1.4	0 ... 31.5
0 ... 1.6	0 ... 40
0 ... 2	0 ... 60
0 ... 2.5	0 ... 70
0 ... 3	0 ... 100

Vacuum and +/- measuring ranges

bar	
-1 ... 0	-1 ... +6
-1 ... +0.6	-1 ... +7
-1 ... +1	-1 ... +9
-1 ... +1.5	-1 ... +10
-1 ... +2	-1 ... +15
-1 ... +3	-1 ... +24
-1 ... +4	-1 ... +25
-1 ... +5	-1 ... +30

kg/cm ²	
-1 ... 0	-1 ... +5
-1 ... +0.6	-1 ... +7
-1 ... +1	-1 ... +9
-1 ... +1.5	-1 ... +10
-1 ... +2	-1 ... +15
-1 ... +3	-1 ... +24
-1 ... +4	-1 ... +30

kPa	
-100 ... 0	-100 ... +500
-100 ... +60	-100 ... +700
-100 ... +100	-100 ... +900
-100 ... +150	-100 ... +1,000
-100 ... +200	-100 ... +1,500
-100 ... +300	-100 ... +2,400
-100 ... +400	-100 ... +3,000

MPa	
-0.1 ... 0	-0.1 ... +0.5
-0.1 ... +0.06	-0.1 ... +0.7
-0.1 ... +0.1	-0.1 ... +0.9
-0.1 ... +0.15	-0.1 ... +1
-0.1 ... +0.2	-0.1 ... +1.5
-0.1 ... +0.3	-0.1 ... +2.4
-0.1 ... +0.4	-0.1 ... +3

psi	
-30 inHg ... 0	-30 inHg ... +100
-30 inHg ... +15	-30 inHg ... +160
-30 inHg ... +30	-30 inHg ... +200
-30 inHg ... +60	-30 inHg ... +300

Further details on: Measuring ranges	
Special measuring ranges	Other measuring ranges on request
Unit	<ul style="list-style-type: none"> ■ bar ■ psi ■ kg/cm² ■ kPa ■ MPa
Increased overload safety	The possibility of selection depends on the scale range
Vacuum resistance	<ul style="list-style-type: none"> ■ Without ■ Vacuum-resistant to -1 bar [-30 inHg]
Dial	
Scale colour	Black
Material	Aluminium
Special scale	<ul style="list-style-type: none"> ■ Without ■ With temperature scale for refrigerant, e.g. for NH₃: R 717 <p>Other scales or customer-specific dials, e.g. with red mark, circular arcs or circular sectors, on request</p>
Pointer	
Instrument pointer	Aluminium, black
Pointer stop pin	<ul style="list-style-type: none"> ■ Without ■ At zero point

Process connection	
Standard	<ul style="list-style-type: none"> ■ EN 837-1 ■ ISO 7 ■ ANSI/B1.20.1
Size	
EN 837-1	<ul style="list-style-type: none"> ■ G 1/8 B, male thread ■ G 1/4 B, male thread ■ G 1/2 B, male thread ■ M10 x 1, male thread ■ M12 x 1.5, male thread
ISO 7	<ul style="list-style-type: none"> ■ R 1/8, male thread ■ R 1/4, male thread
ANSI/B1.20.1	<ul style="list-style-type: none"> ■ 1/4 NPT, male thread ■ 1/2 NPT, male thread
Restrictor	<ul style="list-style-type: none"> ■ Without ■ Ø 0.6 mm [0.024"], stainless steel ■ Ø 0.3 mm [0.012"], stainless steel
Material (wetted)	
Process connection	Stainless steel 1.4571 (316Ti)
Bourdon tube	Stainless steel 1.4404 (316L)

Other process connections on request

Output signal	
Signal type	4 ... 20 mA, 2-wire
Auxiliary power	
Supply voltage	$U_B = DC > 12 \dots \leq 30 \text{ V}$
Permissible residual ripple of supply voltage	< 10 % ss
Load	$R_A \leq (\text{Supply voltage} - 12 \text{ V})/0.02 \text{ A}$, max. 600 Ω

Electrical connection																		
Connection type	<ul style="list-style-type: none"> ■ 2 m [6.6 ft] cable, flying leads ■ 5 m [16.4 ft] cable, flying leads ■ Miniature connector M8 x 1, 4-pin 																	
Wire cross-section	3 x 0.14 mm ²																	
Cable diameter	4 mm [0.16 in]																	
Pin assignment	<table border="1"> <thead> <tr> <th>Colour</th> <th>Pin</th> <th>Assignment</th> </tr> </thead> <tbody> <tr> <td>Red</td> <td>1</td> <td>$U_B/\text{Sig} +$</td> </tr> <tr> <td>Black</td> <td>4</td> <td>0 V/Sig -</td> </tr> <tr> <td>Brown</td> <td>2</td> <td>n. c.</td> </tr> <tr> <td>-</td> <td>3</td> <td>n. c.</td> </tr> </tbody> </table>	Colour	Pin	Assignment	Red	1	$U_B/\text{Sig} +$	Black	4	0 V/Sig -	Brown	2	n. c.	-	3	n. c.	Female connector M8 x 1, 4-pin 	
Colour	Pin	Assignment																
Red	1	$U_B/\text{Sig} +$																
Black	4	0 V/Sig -																
Brown	2	n. c.																
-	3	n. c.																

With cable connection





With miniature connector M8 x 1, 4-pin





Other electrical connections on request

Operating conditions	
Medium temperature	-40 ... +100 °C [-40 ... +212 °F]
Ambient temperature	
Window: Polycarbonate	-20 ... +80 °C [-4 ... +140 °F]
Window: Laminated safety glass	-20 ... +60 °C [-4 ... +140 °F]
Pressure limitation	
Steady	3/4 x full scale value
Fluctuating	2/3 x full scale value
Short time	Full scale value
Ingress protection per IEC/EN 60529	
Without case filling	IP54
With case filling	IP65

Approvals

Logo	Description	Region
	EU declaration of conformity	European Union
	EMC directive	
	Pressure equipment directive PS > 200 bar, module A, pressure accessory	
	UKCA	United Kingdom
	Electromagnetic compatibility regulations	
	Pressure equipment (safety) regulations	
-	CRN Safety (e.g. electr. safety, overpressure, ...)	Canada

Optional approvals

Logo	Description	Region
	EAC EMC directive	Eurasian Economic Community
-	MChS Permission for commissioning	Kazakhstan
	PAC Uzbekistan Metrology, measurement technology	Uzbekistan

Manufacturer's information and certificates

Logo	Description
-	Pressure equipment directive (PED) for maximum allowable pressure $PS \leq 200$ bar
-	Suitability of wetted materials for drinking water in accordance with the European 4MS initiative

Certificates (option)

Certificates	
Certificates	<ul style="list-style-type: none"> ■ 2.2 test report per EN 10204 (e.g. state-of-the-art manufacturing, indication accuracy) ■ 3.1 inspection certificate for indication accuracy per EN 10204 ■ PCA calibration certificate, traceable and accredited in accordance with ISO/IEC 17025 ■ Calibration certificate by a national accreditation body, traceable and accredited in accordance with ISO/IEC 17025 on request
Recommended calibration interval	1 year (dependent on conditions of use)

→ For approvals and certificates, see website

Patents, property rights

Pointer measuring instrument with output signal 4 ... 20 mA (patent, property right: e.g. US 8030990, DE 112007000980, CN 101438333)

Dimensions in mm [in]

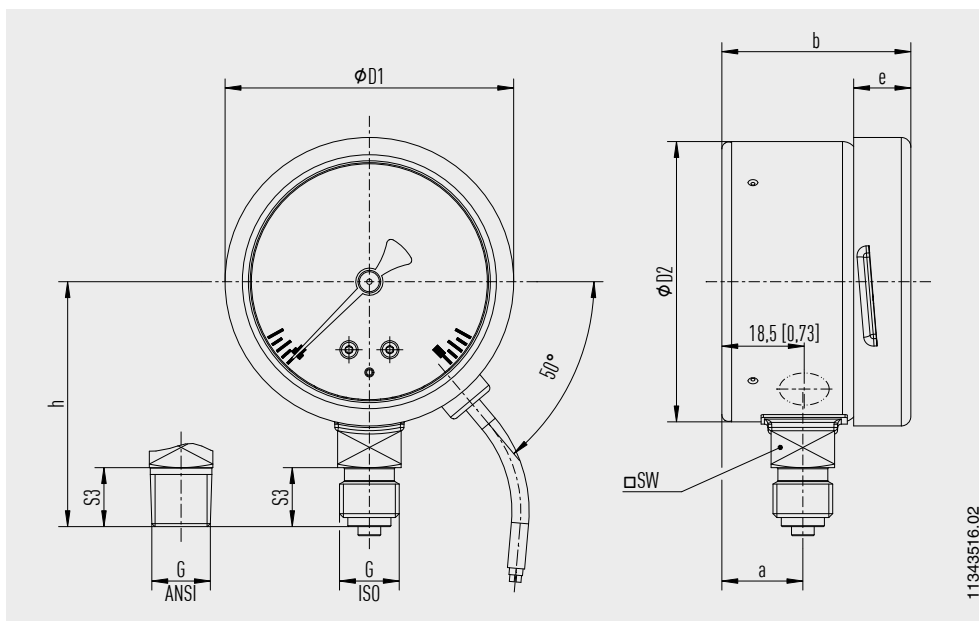









G	Dimensions in mm [in]							
	$h \pm 1$ [0.04]	a	b	D1	D2	e	S3	SW
G ¼ B	54 [2.13]	18 [0.17]	42 [1.65]	63.5 [2.5]	62 [2.44]	12.5 [0.49]	13 [0.51]	14 [0.55]
¼ NPT	54 [2.13]	18 [0.17]	42 [1.65]	63.5 [2.5]	62 [2.44]	12.5 [0.49]	13 [0.51]	14 [0.55]

Weight

Without case filling	approx. 0.52 kg [1.15 lb]
With case filling	approx. 0.6 kg [1.32 lb]

Accessories and spare parts

Model	Description
	910.33 Adhesive label set for red and green circular arcs → See data sheet AC 08.03
	910.17 Sealings → See data sheet AC 09.08
	910.15 Syphons → See data sheet AC 09.06
	910.13 Overpressure protector → See data sheet AC 09.04
	IV10, IV11 Needle valve and multiport valve → See data sheet AC 09.22
	IV20, IV21 Block-and-bleed valve → See data sheet AC 09.19
	IVM Monoflange, process and instrument version → See data sheet AC 09.17
	BV Ball valve, process and instrument version → See data sheet AC 09.28

Ordering information

Model / Case filling / Measuring range / Process connection / Electrical connection / Options

© 09/2008 WIKA Alexander Wiegand SE & Co. KG, all rights reserved.
The specifications given in this document represent the state of engineering at the time of publishing.
We reserve the right to make modifications to the specifications and materials.
In case of a different interpretation of the translated and the English data sheet, the English wording shall prevail.

WIKA data sheet PV 12.03 · 05/2023

Page 9 of 9

Your WIKA Sales Partner



ICS Schneider Messtechnik GmbH
Briesestrasse 59
D-16562 Hohen Neuendorf / OT Bergfelde
Tel.: +49 3303 5040-66
Fax: +49 3303 5040-68
E-Mail: info@ics-schneider.de



WIKAL Alexander Wiegand SE & Co. KG
Alexander-Wiegand-Straße 30
63911 Klingenberg/Germany
Tel. +49 9372 132-0
info@wika.de
www.wika.de