

## Diaphragm pressure gauge with output signal For the process industry, up to 10-fold overload safety, max. 40 bar Models PGT43.100 and PGT43.160

WIKA data sheet PV 14.03



for further approvals see  
page 5

**intelliGAUGE®**

### Applications

- Acquisition and display of processes
- Output signals 4 ... 20 mA, 0 ... 20 mA, 0 ... 10 V for the transmission of process values to the control room
- For measuring points with increased overload
- Easy-to-read, analogue on-site display needing no external power
- Safety-related applications

### Special features

- No configuration necessary due to "plug-and-play"
- Signal transmission per NAMUR
- Scale ranges from 0 ... 16 mbar
- Easy-to-read analogue display with nominal size 100 or 160
- Safety version "S3" per EN 837



intelliGAUGE® model PGT43.100

### Description

Wherever the process pressure has to be indicated locally and, at the same time, a signal transmission to the central control or remote centre is desired, the model PGT43 intelliGAUGE® (patent, property right: e.g. DE 202007019025) can be used.

The model PGT43 is based upon a model 43x.30 high-quality, stainless steel safety pressure gauge with a nominal size of 100 or 160. The pressure measuring instrument is manufactured in accordance with EN 837-3.

The intelliGAUGE model PGT43 fulfils all safety-related requirements of the relevant standards and regulations for the on-site display of the working pressure of pressure vessels. The robust diaphragm measuring system produces a pointer rotation proportional to the pressure.

An electronic angle encoder, proven in safety-critical automotive applications, determines the position of the pointer shaft – it is a non-contact sensor and therefore completely free from wear and friction. From this, the electrical output signal proportional to the pressure, e.g. 4 ... 20 mA, is produced. The measuring span (electrical output signal) is adjusted automatically along with the mechanical display, i.e. the scale over the full display range corresponds to 4 ... 20 mA. The electrical zero point can also be set manually.

The electronic WIKA sensor, integrated into the high-quality diaphragm pressure gauge, combines the advantages of electrical signal transmission with a local mechanical display that remains readable during a power failure. An additional measuring point for mechanical pressure display can thus be saved.

## Specifications

Models PGT43.100 and PGT43.160	
Nominal size in mm	<ul style="list-style-type: none"> <li>■ 100</li> <li>■ 160</li> </ul>
Accuracy class	1.6 Option: 1.0 <sup>1)</sup>
Scale ranges	0 ... 16 mbar to 0 ... 250 mbar (flange Ø 160 mm) 0 ... 400 mbar to 0 ... 25 bar (flange Ø 100 mm) other units (e.g. psi, kPa) available or all other equivalent vacuum or combined pressure and vacuum ranges
Scale	Single scale Option: Dual scale
Pressure limitation	
Steady	Full scale value
Fluctuating	0.9 x full scale value
Overload safety	5 x full scale value, however max. 40 bar Option: <ul style="list-style-type: none"> <li>■ Overload safety up to 10 x full scale value, max. 40 bar</li> <li>■ Vacuum safety to -1 bar</li> </ul>
Process connection with lower measuring flange	<ul style="list-style-type: none"> <li>■ G ½ B</li> <li>■ ½ NPT</li> <li>■ M20 x 1.5</li> <li>■ Open connecting flange DN 25 PN 40 per EN 1092-1, form B</li> <li>■ Open connecting flange DN 50 PN 40 per EN 1092-1, form B</li> <li>■ Open connecting flange 1" class 150, RF per ASME B16.5</li> <li>■ Open connecting flange 2" class 150, RF per ASME B16.5</li> </ul> and other threaded connections and open connecting flanges per EN/ASME from DN 15 to DN 80 (see data sheet IN 00.10)
Permissible temperature <sup>2)</sup>	
Medium	+100 °C [+212 °F] maximum Option: +200 °C [+392 °F] maximum
Ambient	-20 ... +60 °C [-4 ... 140 °F]
Temperature effect	When the temperature of the measuring system deviates from the reference temperature (+20 °C): max. ±0.8 %/10 K of full scale value
Case	Safety version S3 per EN 837: With solid baffle wall (Solidfront) and blow-out back Instruments with liquid filling with compensating valve to vent case
Case filling	Without Option: With silicone oil M50 case filling, ingress protection IP65

1) Application test required

2) For hazardous areas, the permissible temperatures of the output signal variant 2 will apply exclusively (see page 3). These must not be exceeded at the instrument either (for details see operating instructions). If necessary, measures for cooling (e.g. syphon, instrumentation valve, etc.) have to be taken.

## Models PGT43.100 and PGT43.160

<b>Wetted materials</b>	
Diaphragm element (pressure element)	≤ 0.25 bar: Stainless steel 316L > 0.25 bar: NiCr alloy (Inconel) Option: Coated with special materials such as PTFE, Hastelloy, Monel, nickel, tantalum, titanium, silver (instruments with accuracy class 2.5)
Process connection with lower measuring flange	Stainless steel 316L Option: Lined/coated with special materials such as PTFE, Hastelloy, Monel, nickel, tantalum, titanium, silver
Pressure chamber sealing	FPM/FKM
<b>Non-wetted materials</b>	
Case with upper measuring flange, movement, bayonet ring	Stainless steel
Dial	Aluminium, white, black lettering
Instrument pointer	Aluminium, black
Set pointer	Aluminium, red
Window	Laminated safety glass
<b>Ingress protection per IEC/EN 60529</b>	IP54 Option: IP65

## Accessories

- Sealings (model 910.17, see data sheet AC 09.08)
- Valves (models IV20/IV21, see data sheet AC 09.19, and models IV10/IV11, see data sheet AC 09.22)
- Syphons (model 910.15, see data sheet AC 09.06)
- Cooling element (model 910.32, see data sheet AC 09.21)
- Switch contacts (see data sheet AC 08.01)

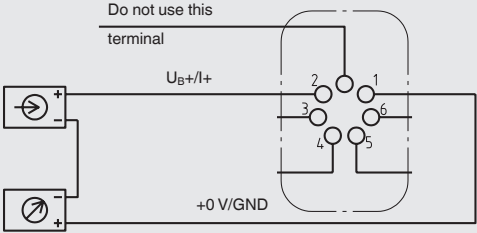
Models PGT43.100 and PGT43.160	
<b>Output signal</b>	Variant 1: 4 ... 20 mA, 2-wire, passive, per NAMUR NE 43 Variant 2: 4 ... 20 mA, 2-wire, for hazardous areas Variant 3: 0 ... 20 mA, 3-wire Variant 4: 0 ... 10 V, 3-wire
<b>Supply voltage <math>U_B</math></b>	DC 12 V < $U_B$ ≤ 30 V (variant 1 and 3) DC 14 V < $U_B$ ≤ 30 V (variant 2) DC 15 V < $U_B$ ≤ 30 V (variant 4)
<b>Influence of supply voltage</b>	≤ 0.1 % of full scale/10 V
<b>Permissible residual ripple of <math>U_B</math></b>	≤ 10 % ss
<b>Permissible max. load <math>R_A</math></b>	Variant 1, 2, 3: $R_A \leq (U_B - 12 \text{ V})/0.02 \text{ A}$ with $R_A$ in $\Omega$ and $U_B$ in V, however max. 600 $\Omega$ Variant 4: $R_A = 100 \text{ k}\Omega$
<b>Effect of load (variant 1, 2, 3)</b>	≤ 0.1 % of full scale
<b>Impedance at voltage output</b>	0.5 $\Omega$
<b>Electrical zero point</b>	Through a jumper across terminals 5 and 6 (see operating instructions)
<b>Long-term stability of electronics</b>	< 0.3 % of full scale per year
<b>Electr. output signal</b>	≤ 1 % of measuring span
<b>Linear error</b>	≤ 1 % of measuring span (terminal method)
<b>Resolution</b>	0.13 % of full scale (10 bit resolution at 360°)
<b>Refresh rate (measuring rate)</b>	600 ms
<b>Electrical connection</b>	Cable socket PA 6, black Per VDE 0110 insulation group C/250 V Cable gland M20 x 1.5 Strain relief 6 screw terminals + PE for conductor cross-section 2.5 mm <sup>2</sup>
<b>Designation of connection terminals, 2-wire (variant 1 and 2)</b>	 <p>Do not use this terminal</p> <p><math>U_B+/I+</math></p> <p>3</p> <p>4</p> <p>5</p> <p>6</p> <p>+0 V/GND</p> <p>Terminals 3 and 4: For internal use only Terminals 5 and 6: Reset zero point</p>
Designation of connection terminals for 3-wire (variant 3 and 4), see operating instructions	

### Safety-related maximum values (variant 2)

$U_i$	$I_i$	$P_i$	$C_i$	$L_i$
DC 30 V	100 mA	720 mW	11 nF	negligible

### Permissible temperature ranges (variant 2)











T6	T5	T4 ... T1
-20 ... +45 °C	-20 ... +60 °C	-20 ... +70 °C

T85°C	T100°C	T135°C
-20 ... +45 °C	-20 ... +60 °C	-20 ... +70 °C

For further information on hazardous areas, see operating instructions.

## Approvals

Logo	Description	Country
 	<b>EU declaration of conformity</b> <ul style="list-style-type: none"> <li>■ EMC directive</li> <li>■ Pressure equipment directive</li> <li>■ RoHS directive</li> <li>■ ATEX directive (option)</li> </ul> Hazardous areas - Ex ia Gas [II 2G Ex ia IIC T6/T5/T4 Gb] <sup>1)</sup> Dust [II 2D Ex ia IIIB T85°C/T100°C/T135°C Db] <sup>2)</sup>	European Union
	<b>IECEx (option)</b> Hazardous areas - Ex ia Gas [Ex ia IIC T6/T5/T4 Gb] <sup>1)</sup> Dust [Ex ia IIIB T85°C/T100°C/T135°C Db] <sup>2)</sup>	International
	<b>EAC (option)</b> <ul style="list-style-type: none"> <li>■ EMC directive</li> <li>■ Pressure equipment directive</li> <li>■ Low voltage directive</li> <li>■ Hazardous areas</li> </ul>	Eurasian Economic Community
	<b>GOST (option)</b> Metrology, measurement technology	Russia
	<b>KazInMetr (option)</b> Metrology, measurement technology	Kazakhstan
-	<b>MTSCHS (option)</b> Permission for commissioning	Kazakhstan
	<b>BelGIM (option)</b> Metrology, measurement technology	Belarus
	<b>UkrSEPRO (option)</b> Metrology, measurement technology	Ukraine
	<b>DNOP (MakNII) (option)</b> <ul style="list-style-type: none"> <li>■ Hazardous areas</li> </ul>	Ukraine
	<b>Uzstandard (option)</b> Metrology, measurement technology	Uzbekistan
-	<b>CRN</b> Safety (e.g. electr. safety, overpressure, ...)	Canada

1) For instruments with PTFE lining, measures must be taken in the lining area, if necessary, in order to exclude electrostatic charging.

2) Only for instruments without PTFE lining

## Certificates (option)

- 2.2 test report per EN 10204 (e.g. state-of-the-art manufacturing, indication accuracy)
- 3.1 inspection certificate per EN 10204 (e.g. indication accuracy)

## Patents, property rights

Pointer measuring instrument with output signal 4 ... 20 mA (patent, property right: e.g. DE 202007019025, US 2010045366, CN 101438333)

Approvals and certificates, see website

## Dimensions in mm

### Standard version

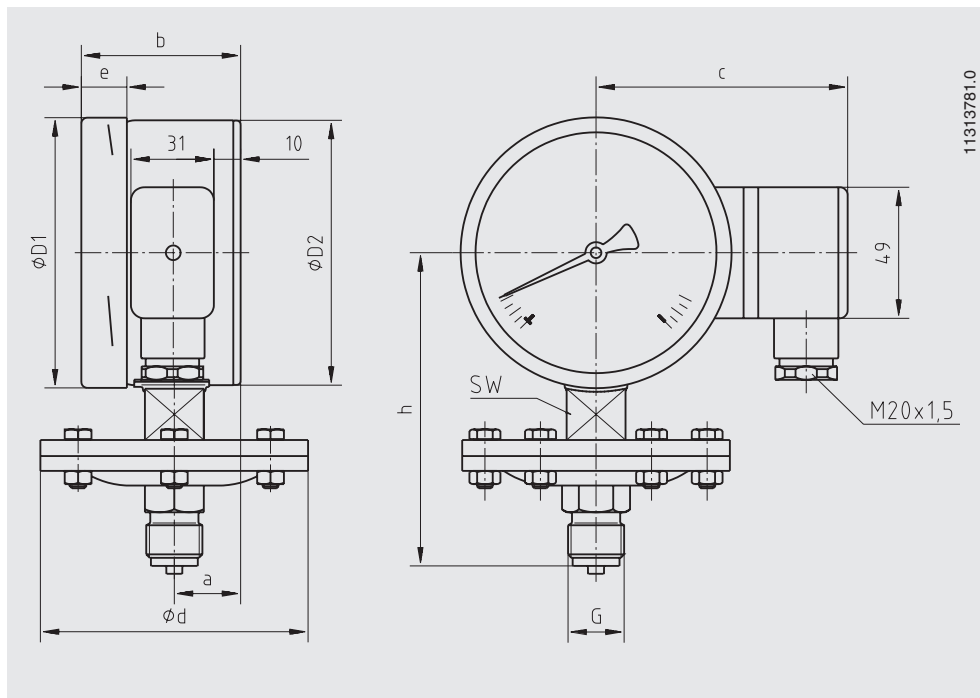

NS	Scale range	Dimensions in mm										Weight in kg
	in bar	a	b	c	d	D <sub>1</sub>	D <sub>2</sub>	e	G	h ±1	SW	
100	≤ 0 ... 250 mbar	25	59.5	94	160	101	99	17	G ½ B	119	22	2.5
100	> 0 ... 250 mbar	25	59.5	94	100	101	99	17	G ½ B	117	22	1.3
160	≤ 0 ... 250 mbar	25	65	124	160	161	159	17	G ½ B	149	22	2.9
160	> 0 ... 250 mbar	25	65	124	100	161	159	17	G ½ B	149	22	1.7

### Ordering information

Model / Nominal size / Scale range / Output signal / Connection location / Process connection / Options

© 11/2007 WIKA Alexander Wiegand SE & Co. KG, all rights reserved.  
The specifications given in this document represent the state of engineering at the time of publishing.  
We reserve the right to make modifications to the specifications and materials.

Your WIKA Sales Partner



**ICS Schneider Messtechnik GmbH**  
Briesestrasse 59  
D-16562 Hohen Neuendorf / OT Bergfelde  
Tel.: +49 3303 5040-66  
Fax: +49 3303 5040-68  
E-Mail: info@ics-schneider.de



**WIKAL Alexander Wiegand SE & Co. KG**  
Alexander-Wiegand-Straße 30  
63911 Klingenberg/Germany  
Tel. +49 9372 132-0  
Fax +49 9372 132-406  
info@wika.de  
www.wika.de