

Differential pressure gauge with output signal

For the process industry, high overload safety up to 400 bar

Models DPGT43HP.100 and DPGT43HP.160

WIKA data sheet PV 17.13



for further approvals see page 5

intelliGAUGE®

Applications

- Acquisition and display of processes
- Output signals 4 ... 20 mA, 0 ... 20 mA, 0 ... 10 V for the transmission of process values to the control room
- For measuring locations with a high differential pressure overload and/or high working pressures (static pressures), also in aggressive environments
- Easy-to-read, analogue on-site display needing no external power

Special features

- High working pressure (static pressure) and high overload safety, selectable up to 40, 100, 250 or 400 bar
- Measuring cell liquid dampening against rapid pressure changes
- No configuration necessary due to “plug-and-play”
- Differential pressure measuring ranges from 0 ... 60 mbar
- Individual, non-linear characteristic curves (e.g. x^2 or \sqrt{x} for flow measurement)



Differential pressure gauge, model DPGT43HP.100

Description

Wherever the differential pressure must be indicated locally and, at the same time, a signal transmission to the central control or remote centre is desired, the model DPGT43 intelliGAUGE® (patent, property right: e.g. DE 202007019025) can be used.

The model DPGT43 is based upon a model 732.14 high-quality, stainless steel pressure gauge with a nominal size of 100 or 160. The pressure measuring instrument is manufactured in accordance with EN 837-3.

The use of high-quality stainless steel materials and the robust design are geared to applications in the chemical and process engineering industries. Thus the instrument is suitable for liquid and gaseous media, also in aggressive environments.

A high overload safety is achieved by the all-metal construction and the close-fitting design of the pressure element.

The robust diaphragm measuring system produces a pointer rotation proportional to the pressure. An electronic angle encoder, proven in safety-critical automotive applications, determines the position of the pointer shaft – it is a non-contact sensor and therefore completely free from wear and friction. From this, the electrical output signal, proportional to the pressure, of 4 ... 20 mA, is produced. In addition, the electrical zero point can be set manually.

The electronic WIKA sensor, integrated into the high-quality mechanical differential pressure gauge, combines the advantages of electrical signal transmission with a local mechanical display that remains readable during a power failure. An additional measuring point with a mechanical pressure display can thus be saved.

Specifications

Models DPGT43HP.100 and DPGT43HP.160	
Design	Highest overload safety either side, pressure ratings PN 40, 100, 250 or 400, system fill fluid of the measuring cell acts as the dampening of the display. Overload resistance per EN 837-3.
Nominal size in mm	<ul style="list-style-type: none"> ■ 100 ■ 160
Accuracy class	1.6 Option: <ul style="list-style-type: none"> ■ 1.0 (application test required) ■ 2.5 (Monel version)
Scale ranges	Instruments with PN 40 and 100: <ul style="list-style-type: none"> ■ 0 ... 60 mbar to 0 ... 160 mbar (measuring cell □ 140) ■ 0 ... 0.25 bar to 0 ... 40 bar (measuring cell □ 82) Instruments with PN 250: <ul style="list-style-type: none"> ■ 0 ... 60 mbar to 0 ... 250 mbar (measuring cell □ 140) ■ 0 ... 0.4 bar to 0 ... 40 bar (measuring cell □ 82) Instruments with PN 400: 0 ... 0.4 bar to 0 ... 40 bar (measuring cell □ 86) Dimensions of measuring cell from page 7 other units (e.g. psi, kPa) available or all other equivalent vacuum or combined pressure and vacuum ranges
Scale	Single scale Option: <ul style="list-style-type: none"> ■ Dual scale ■ Scale layout with individual non-linear characteristic curves
Zero point setting	By means of adjustment appliance
Pressure limitation	
Steady	Full scale value
Fluctuating	0.9 x full scale value Observe the recommendations for the use of mechanical pressure measuring systems in accordance with EN 837-2
Overload safety and max. working pressure (static pressure)	Either side max. 40, 100, 250 or 400 bar
Connection location	Lower mount (radial) Option: <ul style="list-style-type: none"> ■ Back mount ■ Connection at 12 o'clock
Process connection	<ul style="list-style-type: none"> ■ G ½ B female ■ G ½ B male ■ ½ NPT male ■ Differential process connection per EN 61518 Other process connections via female or male threads on request
Permissible temperature ¹⁾	
Medium	-20 ... +100 °C
Ambient	-20 ... +60 °C Option: -40 ... +60 °C (silicone oil filling)
Temperature effect	When the temperature of the measuring system deviates from the reference temperature (+20 °C): max. ±0.5 %/10 K of full scale value
Case filling	Without Option: With case filling

¹⁾ For hazardous areas, the permissible temperatures of the output signal variant 2 will apply exclusively (see page 4). These must not be exceeded at the instrument either (for details see operating instructions). If necessary, measures for cooling (e.g. syphon, instrumentation valve, etc.) have to be taken.

Models DPGT43HP.100 and DPGT43HP.160	
Venting of the media chambers	<ul style="list-style-type: none"> ■ Instruments with PN 40 and 100: For scale ranges ≤ 0.16 bar (option for scale ranges ≥ 0.25 bar) ■ Instruments with PN 250 and 400: Standard for scale ranges ≤ 0.25 bar (option for scales ranges ≥ 0.4 bar)
System fill fluid of measuring cell	Silicone oil Option: Measuring cell filling with special medium, e.g. for use in oxygen applications Others on request
Wetted materials	
Measuring flanges with process connection	Stainless steel 316L
Pressure elements	<ul style="list-style-type: none"> ■ ≤ 0.25 bar: Stainless steel 1.4571 ■ > 0.25 bar: NiCr alloy (Inconel)
Measuring cell	Chrome steel
Venting of the media chambers	Stainless steel 316L
Sealings	FPM/FKM
Non-wetted materials	
Flange connecting screws	<ul style="list-style-type: none"> ■ PN 40 / 100: Stainless steel ■ PN 250 / 400: Steel, corrosion-protected
Case, movement, bayonet ring	Stainless steel
Dial	Aluminium, white, black lettering
Pointer	Aluminium, black
Window	Laminated safety glass
Ingress protection per IEC/EN 60529	IP54 ¹⁾ Option: IP65 with liquid filling
Installation	According to affixed symbols: \oplus high pressure, \ominus low pressure
Mounting	<ul style="list-style-type: none"> ■ Rigid measuring lines ■ Drilled mounting holes at the back of the measuring cell Option: <ul style="list-style-type: none"> ■ Panel mounting flange ■ Instrument mounting bracket for wall or pipe mounting

1) Ingress protection IP54 with safety version and lower back mount.

Other versions

Wetted parts made of special material (Monel, PTFE lining)

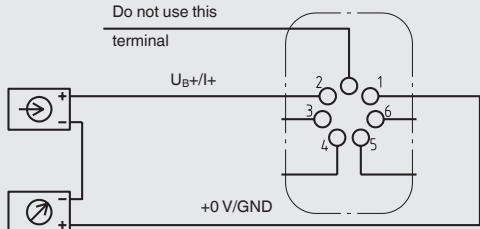
Models DPGT43HP.100 and DPGT23HP.160	
Output signal	Variant 1: 4 ... 20 mA, 2-wire, passive, per NAMUR NE 43 Variant 2: 4 ... 20 mA, 2-wire, for hazardous areas Variant 3: 0 ... 20 mA, 3-wire Variant 4: 0 ... 10 V, 3-wire
Supply voltage U_B	DC 12 V < U_B ≤ 30 V (variant 1 and 3) DC 14 V < U_B ≤ 30 V (variant 2) DC 15 V < U_B ≤ 30 V (variant 4)
Influence of supply voltage	≤ 0.1 % of full scale/10 V
Permissible residual ripple of U_B	≤ 10 % ss
Permissible max. load R_A	Variants 1, 2, 3: $R_A \leq (U_B - 12 \text{ V})/0.02 \text{ A}$ with R_A in Ω and U_B in V, however max. 600 Ω Variant 4: $R_A = 100 \text{ k}\Omega$
Effect of load (variant 1, 2, 3)	≤ 0.1 % of full scale
Impedance at voltage output	0.5 Ω
Electrical zero point	Through a jumper across terminals 5 and 6 (see operating instructions)
Long-term stability of electronics	< 0.3 % of full scale per year
Electr. output signal	≤ 1 % of measuring span
Linear error	≤ 1 % of measuring span (terminal method)
Resolution	0.13 % of full scale (10 bit resolution at 360°)
Refresh rate (measuring rate)	600 ms
Electrical connection	Cable socket PA 6, black Per VDE 0110 insulation group C/250 V Cable gland M20 x 1.5 Strain relief 6 screw terminals + PE for conductor cross-section 2.5 mm ²
Designation of connection terminals, 2-wire (variant 1 and 2)	 <p>Do not use this terminal</p> <p>$U_B+/+$</p> <p>3 4</p> <p>5 6</p> <p>+0 V/GND</p> <p>Terminals 3 and 4: For internal use only Terminals 5 and 6: Reset zero point</p>
Designation of connection terminals for 3-wire (variant 3 and 4), see operating instructions	

Safety-related maximum values (variant 2)

U_i	I_i	P_i	C_i	L_i
DC 30 V	100 mA	720 mW	11 nF	negligible











Permissible temperature ranges (variant 2)

T6	T5	T4 ... T1
-20 ... +45 °C	-20 ... +60 °C	-20 ... +70 °C

T85°C	T100°C	T135°C
-20 ... +45 °C	-20 ... +60 °C	-20 ... +70 °C

For further information on hazardous areas, see operating instructions.

Approvals

Logo	Description	Country
	EU declaration of conformity <ul style="list-style-type: none"> ■ EMC directive ■ Pressure equipment directive ■ RoHS directive ■ ATEX directive (option) Hazardous areas - Ex ia Gas [II 2G Ex ia IIC T6/T5/T4 Gb] Dust [II 2D Ex ia IIIB T85 °C/T100 °C/T135 °C Db]	European Union
	IECEx (option) Hazardous areas - Ex ia Gas [Ex ia IIC T6/T5/T4 Gb] Dust [Ex ia IIIB T85 °C/T100 °C/T135 °C Db]	International
	EAC (option) <ul style="list-style-type: none"> ■ EMC directive ■ Pressure equipment directive ■ Low voltage directive ■ Hazardous areas 	Eurasian Economic Community
	GOST (option) Metrology, measurement technology	Russia
	KazInMetr (option) Metrology, measurement technology	Kazakhstan
-	MTSCHS (option) Permission for commissioning	Kazakhstan
	BelGIM (option) Metrology, measurement technology	Belarus
	UkrSEPRO (option) Metrology, measurement technology	Ukraine
	Ex Ukraine (option) Hazardous areas	Ukraine
	Uzstandard (option) Metrology, measurement technology	Uzbekistan
	NEPSI (option) Hazardous areas	China
-	CRN Safety (e.g. electr. safety, overpressure, ...)	Canada

Certificates (option)

- 2.2 test report per EN 10204 (e.g. state-of-the-art manufacturing, indication accuracy)
- 3.1 inspection certificate per EN 10204 (e.g. indication accuracy)

Patents, property rights

Pointer measuring instrument with output signal
 4 ... 20 mA (patent, property right: e.g. DE 202007019025,
 US 2010045366, CN 101438333)

Approvals and certificates, see website

Accessories

- Sealings (model 910.17, see data sheet AC 09.08)
- Valves (models IV3x/IV5x, see data sheet AC 09.23)
- Diaphragm seal

Dimensions in mm

intelliGAUGE® models DPGT43.100 and DPGT43.160

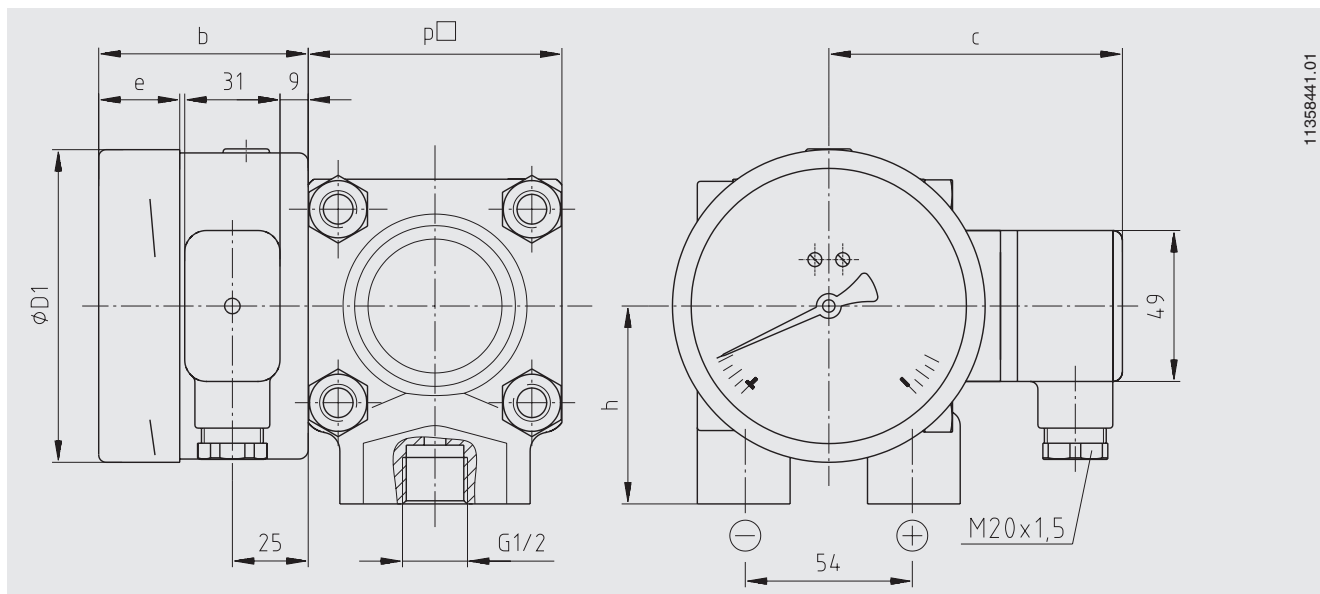

NS	Scale range	Dimensions in mm					Weight in kg		
		b	D1	h ±1	p□ (PN 40/100/250)	p□ (PN 400)	PN 40/100	PN 250	PN 400
100	≤ 0 ... 250 mbar	58.5	101	86	140	-	12.1	13.1	-
100	> 0 ... 250 mbar	58.5	101	64	82	86	3.6	3.9	4.5
160	≤ 0 ... 250 mbar	65.5	161	86	140	-	12.5	13.5	-
160	> 0 ... 250 mbar	65.5	161	64	82	86	4.0	4.3	4.9

Ordering information

Model / Nominal size / Scale range / Output signal / Connection location / Process connection / Scale layout (linear pressure or square root incrementation) / Max. working pressure (static pressure) / Options

© 11/2007 WIKA Alexander Wiegand SE & Co. KG, all rights reserved.
The specifications given in this document represent the state of engineering at the time of publishing.
We reserve the right to make modifications to the specifications and materials.

Your WIKA Sales Partner



ICS Schneider Messtechnik GmbH
Briesestr. 59
D-16562 Hohen Neuendorf / OT Bergfelde
Tel.: +49 3303 5040-66
Fax: +49 3303 5040-68
E-Mail: info@ics-schneider.de



WIKAL Alexander Wiegand SE & Co. KG
Alexander-Wiegand-Straße 30
63911 Klingenberg/Germany
Tel. +49 9372 132-0
Fax +49 9372 132-406
info@wika.com
www.wika.com