

Hand-held pressure indicator With external reference pressure sensor, 1- or 2-channel version Models CPH6200-S1 and CPH6200-S2

WIKA data sheet CT 11.01



for further approvals
see page 5

Applications

- Calibration service companies and service industry
- Measurement and control laboratories
- Pressure tests

Special features

- Digital indicator with interchangeable pressure sensors (plug-and-play)
- Measuring ranges 0 ... 1,000 bar [0 ... 14,500 psi]
- Type of pressure: Positive and negative overpressure, absolute pressure and differential pressure
- Accuracy: 0.2 %, optionally 0.1 % (incl. calibration certificate)
- Data logger for recording measured values



Model CPH6200-S1 hand-held pressure indicator with external model CPT6200 reference pressure sensor

Description

Extensive application possibilities

For the hand-held pressure indicator model CPH6200, external reference pressure sensors of model CPT6200 with measuring ranges of up to 1,000 bar [14,500 psi] are available. Therefore, it is particularly suitable as a test instrument for applications such as process technology, machine building, etc. The digital indicator automatically detects the measuring range of the connected pressure sensor and guarantees a highly accurate pressure measurement.

Functionality

The CPH6200 can be used for measuring both gauge and absolute pressure. Differential pressure measurement is possible with the 2-channel version CPH6200-S2, and two connected model CPT6200 reference pressure sensors. Pressure units selectable on the instrument are: bar, mbar, psi, Pa, kPa, MPa, mmHg or inHg.

An integrated data logger and various other functions such as Min., Max., Hold, Tare, zero point adjustment, alarm, power-off, peak value detection (1,000 measurements/s), average value filter, etc. ensure that the CPH6200 can be used for many different applications.

Software

In addition to the GSoft data logger evaluation software for the tabular and graphical representation of the logged data, WIKA-Cal calibration software for calibration tasks is also available. WIKA-Cal also offers, over and above PC-supported calibration, the management of the calibration and instrument data in an SQL database. A USB interface is available for the data transfer.

Complete test and service cases

For maintenance and service applications, various case systems are available. These include service cases with or without pressure generation, rechargeable battery, battery charger, connection adapter, etc.

Certified accuracy

For each reference pressure sensor, the accuracy for the complete measuring chain is certified by a factory calibration certificate which accompanies the instrument. On request, we can provide a DAkkS calibration certificate for this instrument.

Specifications

Digital indicator model CPH6200	
Electrical connection for reference pressure sensor	
Measuring inputs	<ul style="list-style-type: none">■ 1 input for CPH6200-S1■ 2 inputs for CPH6200-S2
Sensor compatibility	Compatible with reference pressure sensor model CPT6200
Connection to CPH6200	6-pin, shielded mini DIN female connector with interlocking
Sensor connection cable	<ul style="list-style-type: none">■ Cable with 6-pin mini DIN connector and 7-pin bayonet connector, length 1.1 m [3.3 ft]■ Extension cable, length 3.8 m [12.5 ft], overall cable length approx. 5 m [16.4 ft]
Indication	
Display	Large 4 ½-digit LC display for indication of two pressure values and additional information
Indication range	-19999 ... 19999 digits (dependent upon connected reference pressure sensor)
Pressure types	Dependent upon connected reference pressure sensor <ul style="list-style-type: none">■ Gauge pressure, absolute pressure or vacuum■ Differential pressure measurement only with CPH6200-S2, and two model CPT6200 reference pressure sensors connected
Pressure units	Freely adjustable depending on the measuring range <ul style="list-style-type: none">■ bar■ mbar■ psi■ Pa■ kPa■ MPa■ mmHg■ inHg
Functions	
Measuring rate	Measuring rate (can be set via menu) <ul style="list-style-type: none">■ 4/s ("Slo" - slow measurement)■ 1,000/s filtered ("Fast" - fast measurement)■ > 1,000/s unfiltered ("P.det" - peak value detection)
Mean value filter	1 ... 120 seconds (can be set via menu)
Data logger	<ul style="list-style-type: none">■ Individual value logger<ul style="list-style-type: none">⇒ Up to 99 recordings incl. time can be accessed via function button■ Cyclic logger<ul style="list-style-type: none">⇒ Automatic recording of up to 10,000 values incl. time⇒ Cycle time freely adjustable in the range from 1 ... 3,600 seconds
Real-time clock	For data logger, (can be set via menu)
Min./Max. memory	Minimum or maximum measured value (can be accessed via function button)
Hold	Holding the last measured value (can be accessed via function button)
Tare	Tare or zero point correction (can be accessed via function button)
Alarm	Alarm function (can be set via menu) <ul style="list-style-type: none">⇒ Min./Max. alarm (audible/visual)
Sea level (barometric pressure)	Sea level correction -200 ... +9999 m (can be set via menu)
Power-Off function	Automatic switch-off (can be set via menu) <ul style="list-style-type: none">■ Activated (1 ... 120 minutes)■ Deactivated (no automatic switch-off of the instrument)

Digital indicator model CPH6200

Voltage supply

Power supply	9 V battery, alternatively 9 V rechargeable battery or mains supply
Battery life	> 300 hours of operation (1 sensor with a measuring rate of 4/s)

Permissible ambient conditions

Operating temperature	-10 ... +50 °C [14 ... 122 °F]
Storage temperature	-20 ... +70 °C [-4 ... +158 °F]
Relative humidity	0 ... 95 % r. h. (non-condensing)

Output signals/interfaces

Serial interface	RS-232 or USB (instrument-specific interface cable required)
Analogue output	DC 0 ... 1 V; configurable (can be activated via menu as an alternative to the serial interface, instrument-specific connection cable required)
Connection	Stereo jack connector, 3.5 mm

Case

Material	Impact-resistant ABS plastic, membrane keyboard, transparent screen, silicone protective casing
Dimensions	See technical drawing
Weight	Approx. 160 g [0.35 lbs] (incl. batteries)

Reference pressure sensor model CPT6200

Measuring range

Gauge pressure	mbar	-600 ... 0 ¹⁾	-600 ... +600 ¹⁾	-400 ... 0 ¹⁾	-400 ... +400 ¹⁾
		-250 ... 0 ¹⁾	-250 ... +250 ¹⁾	-100 ... +100 ¹⁾	-19.99 ... +60 ^{1) 2)}
		-19.99 ... +40 ^{1) 2)}	-19.99 ... +25 ^{1) 2)}	0 ... 25 ^{1) 2)}	0 ... 40 ^{1) 2)}
		0 ... 60 ^{1) 2)}	0 ... 100 ¹⁾	0 ... 160 ¹⁾	0 ... 250
		0 ... 400	0 ... 600		
Gauge pressure	bar	-1 ... 0 ¹⁾	-1 ... 1.5 ¹⁾	-1 ... 3 ¹⁾	-1 ... 5 ¹⁾
		-1 ... 9 ¹⁾	-1 ... 15 ¹⁾	-1 ... 24 ¹⁾	-1 ... 39 ¹⁾
		0 ... 1	0 ... 1.6	0 ... 2.5	0 ... 4
		0 ... 6	0 ... 10	0 ... 16	0 ... 25
		0 ... 40	0 ... 60	0 ... 70	0 ... 100
		0 ... 160	0 ... 250	0 ... 400	0 ... 600
		0 ... 1,000			
	psi	0 ... 5	0 ... 10	0 ... 15	0 ... 20
		0 ... 30	0 ... 50	0 ... 100	0 ... 150
		0 ... 200	0 ... 300	0 ... 500	0 ... 1,000
		0 ... 1,500	0 ... 2,000	0 ... 3,000	0 ... 6,000
Absolute pressure	mbar abs.	0 ... 250	0 ... 400	0 ... 600	
		bar abs.	0 ... 1	0 ... 1.2	0 ... 1.6
		0 ... 4	0 ... 6	0 ... 10	0 ... 16
		0 ... 25	0.8 ... 1.2		
	psi abs.	0 ... 5	0 ... 10	0 ... 15	0 ... 20
		0 ... 30	0 ... 50	0 ... 100	0 ... 150
		0 ... 200			
Overpressure safety		3 times; ≤ 25 bar 2 times; > 25 bar ... ≤ 600 bar 1.5 times; > 600 bar		3 times; ≤ 360 psi 2 times; > 360 psi ... ≤ 8,700 psi 1.5 times; > 8,700 psi	

Reference pressure sensor model CPT6200

Process connection

G ½ B	For all measuring ranges
G ½ B flush ³⁾	For measuring ranges > 1.6 ... < 1,000 bar and bar abs. For measuring ranges > 20 ... < 14,500 psi and psi abs.
G 1 B flush ³⁾	For measuring ranges ≥ 0.1 ... ≤ 1.6 bar and bar abs. For measuring ranges > 5 ... ≤ 20 psi and psi abs.
Adapter	Various connection adapters on request

Material

Wetted parts	Measuring ranges ≥ 0.1 ... 25 bar [≥ 1.45 ... 360 psi] ■ Stainless steel or ■ Elgiloy®
	Measuring ranges > 25 bar [> 360 psi] ■ Stainless steel and sealing from NBR or ■ Elgiloy® and sealing from NBR
	Measuring ranges < 100 mbar [< 1.45 psi] ■ Stainless steel ■ Gold ■ Silicon ■ Silicone ■ Aluminium
	Oxygen version, measuring ranges ≥ 0.25 bar [≥ 0.4 psi] ■ Stainless steel or ■ Elgiloy®
	Flush version ■ Stainless steel with O-ring from NBR or ■ Stainless steel with O-ring from EPDM or ■ Hastelloy C4 with O-ring from NBR or ■ Hastelloy C4 with O-ring from EPDM
Pressure transmission medium	For measuring ranges to ≤ 16 bar [≤ 250 psi] synthetic oil
	For flush version synthetic oil
	For oxygen version halocarbon oil

Permissible ambient conditions

Medium temperature	■ -30 ... +100 °C [-22 ... +212 °F] ■ -10 ... +50 °C [14 ... 122 °F] (only for oxygen version)
Operating temperature	-20 ... +80 °C [-4 ... +176 °F]
Storage temperature	-40 ... +100 °C [-40 ... +212 °F]
Relative humidity	0 ... 95 % r. h. (non-condensing)

Case

Material	Stainless steel
Ingress protection	■ IP65 ■ IP67 when connected
Dimensions	See technical drawing
Weight	Approx. 220 g [0.49 lbs]



- 1) Not available as oxygen version.
2) Exclusively suitable for use with dry, gaseous and non-aggressive media. Not possible as flush version.
3) As an oxygen version or oil- and grease-free version, a flush diaphragm model is not available.

Model CPH6200 hand-held pressure indicator (complete measuring chain)



Accuracy of the measuring chain ¹⁾	■ 0.2 % FS ■ 0.1 % FS at reference conditions ²⁾ (not for pressure ranges < 100 mbar [< 1.45 psi])
Mean temperature coefficient	≤ 0.2 % of span/10 K (outside the reference conditions) ²⁾
Compensated range	0 ... 80 °C [0 ... 176 °F]

- 1) It is defined by the total measurement uncertainty, which is expressed with the coverage factor (k = 2) and includes the following factors: the intrinsic performance of the instrument, the measurement uncertainty of the reference instrument, long-term stability, influence of ambient conditions, drift and temperature effects over the compensated range during a periodic zero point correction.
2) Reference conditions: 15 ... 25 °C [59 ... 77 °F]

Approvals

Logo	Description	Region
	EU declaration of conformity for CPH6200	European Union
	EMC directive EN 61326 emission (group 1, class B) and immunity (portable equipment)	
	RoHS directive	
	EU declaration of conformity for CPT6200	European Union
	EMC directive EN 61326 emission (group 1, class B) and immunity (portable measuring equipment)	
	Pressure equipment directive Module A, internal production control	
	RoHS directive	

Optional approvals

Logo	Description	Region
	EAC	Eurasian Economic Community
	EMC directive	
	Pressure equipment directive	
	PAC Russland Metrology, measurement technology	Russia
-	MChS Permission for commissioning	Kazakhstan
	PAC Belarus Metrology, measurement technology	Belarus
-	PAC China Metrology, measurement technology	China
-	CRN Safety (e.g. electr. safety, overpressure, ...)	Canada

Certificates

Certificate	
Calibration for model CPT6200	<ul style="list-style-type: none"> ■ 3.1 inspection certificate per EN 10204 (factory calibration) ■ DAkkS calibration certificate (traceable and accredited in accordance with ISO/IEC 17025)
Recommended calibration interval	1 year (dependent on conditions of use)

Approvals and certificates, see website

Dimensions in mm [in]

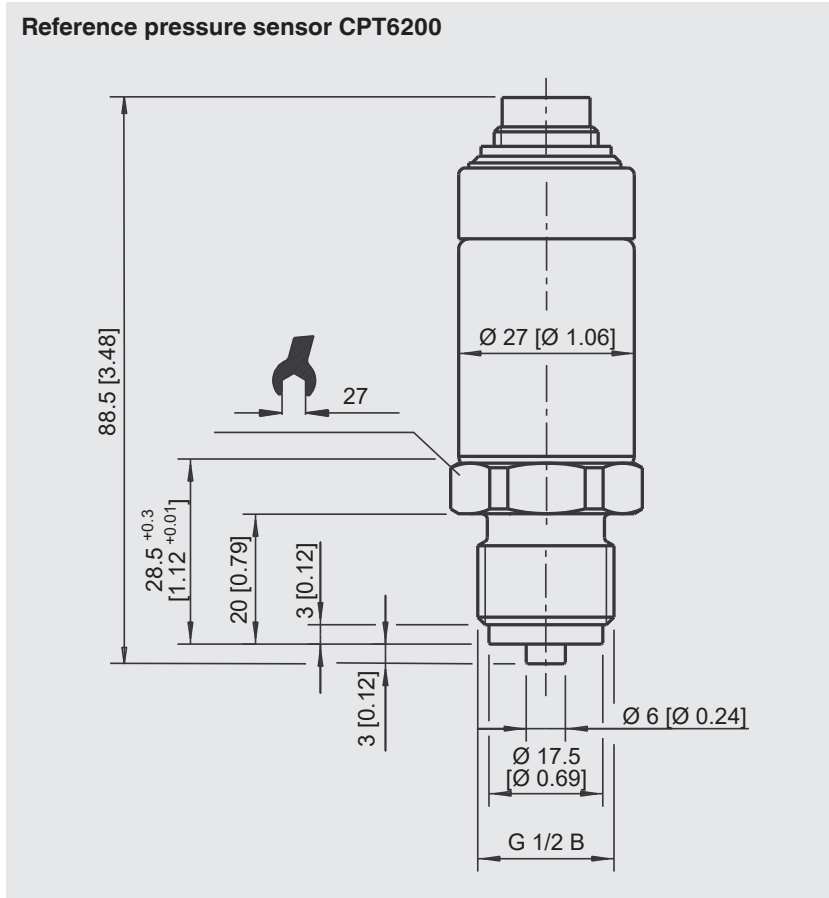
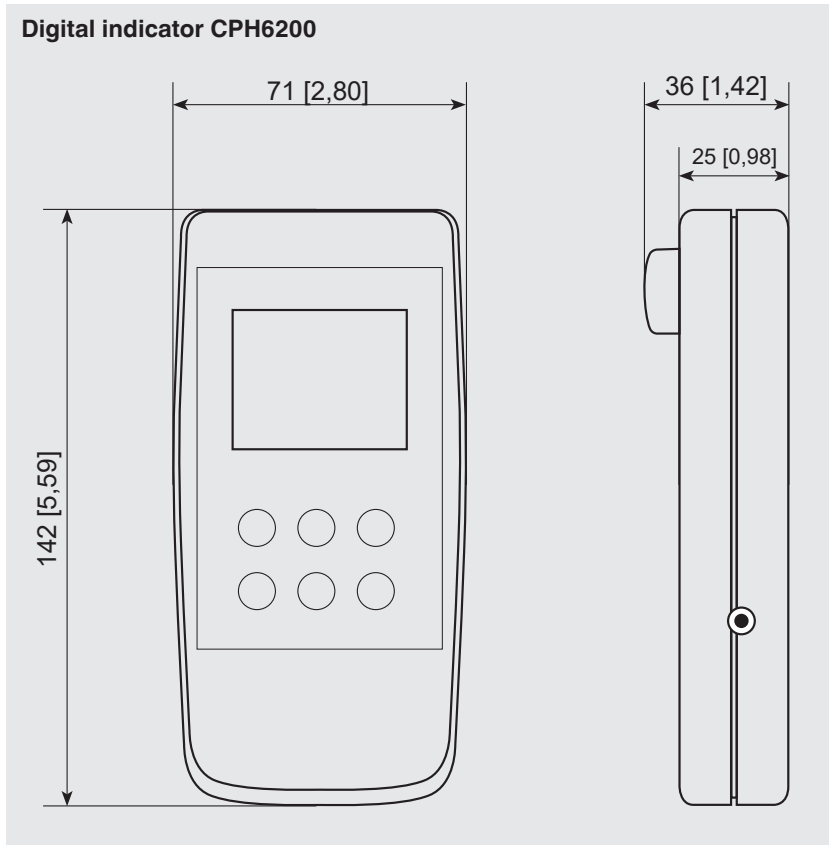

Electrical connections

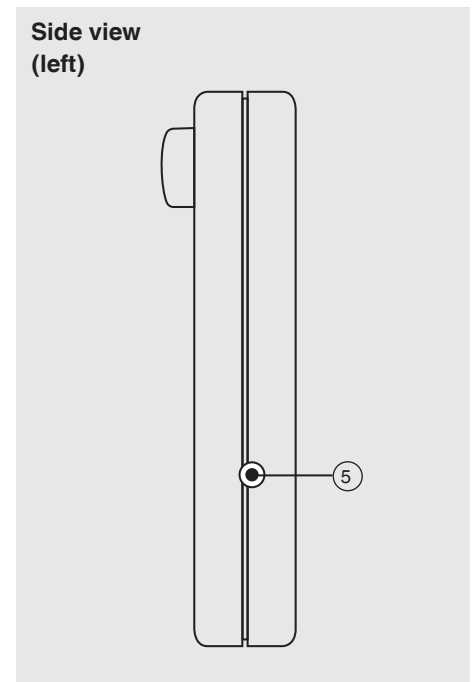
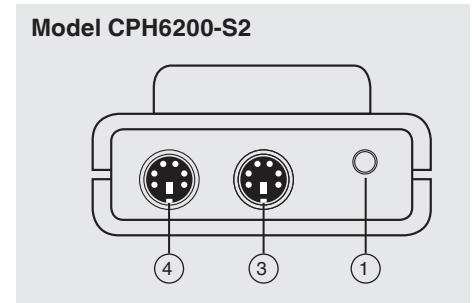
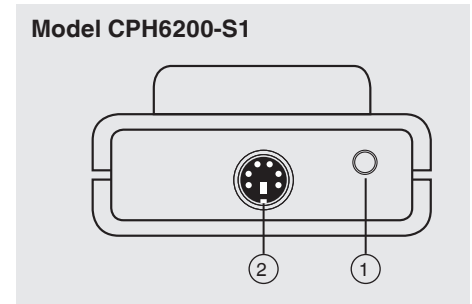

- ① Interface connector or optional analogue output
- ② Pressure connection channel 1 (only with CPH6200-S1)
- ③ Pressure connection channel 2 (only with CPH6200-S2)
- ④ Pressure connection channel 1 (only with CPH6200-S2)
- ⑤ Connection of power supply unit for voltage supply

Operating functions of the models CPH6200-S1 and CPH6200-S2

1- and 2-channel version with external pressure sensors

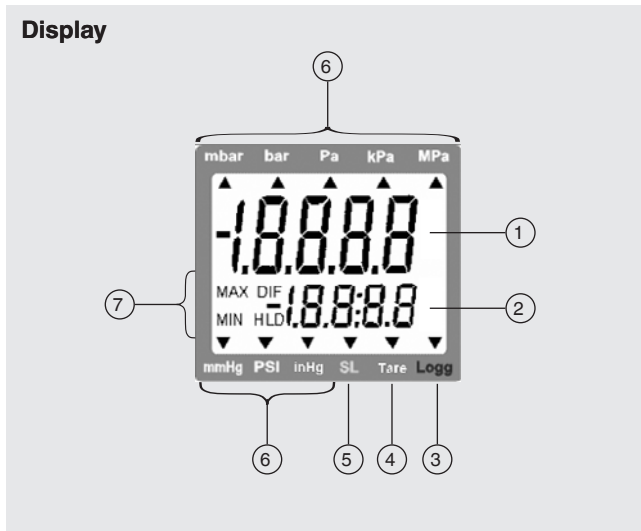

- ① **Main display:** Current measured value for sensor 1
- ② **Secondary display:** Current measured value for sensor 2 or differential value between sensor 1 and sensor 2
- ③ **Logg arrow:** Logger is ready
Arrow blinking: Automatic recording (Logg CYCL) active
- ④ **Tare arrow:** Tare function was activated
- ⑤ **SL arrow:** Altitude correction (sea level) was activated
- ⑥ Display arrows for **measured value units**
- ⑦ Indicating elements for Min./Max. measured value illustration

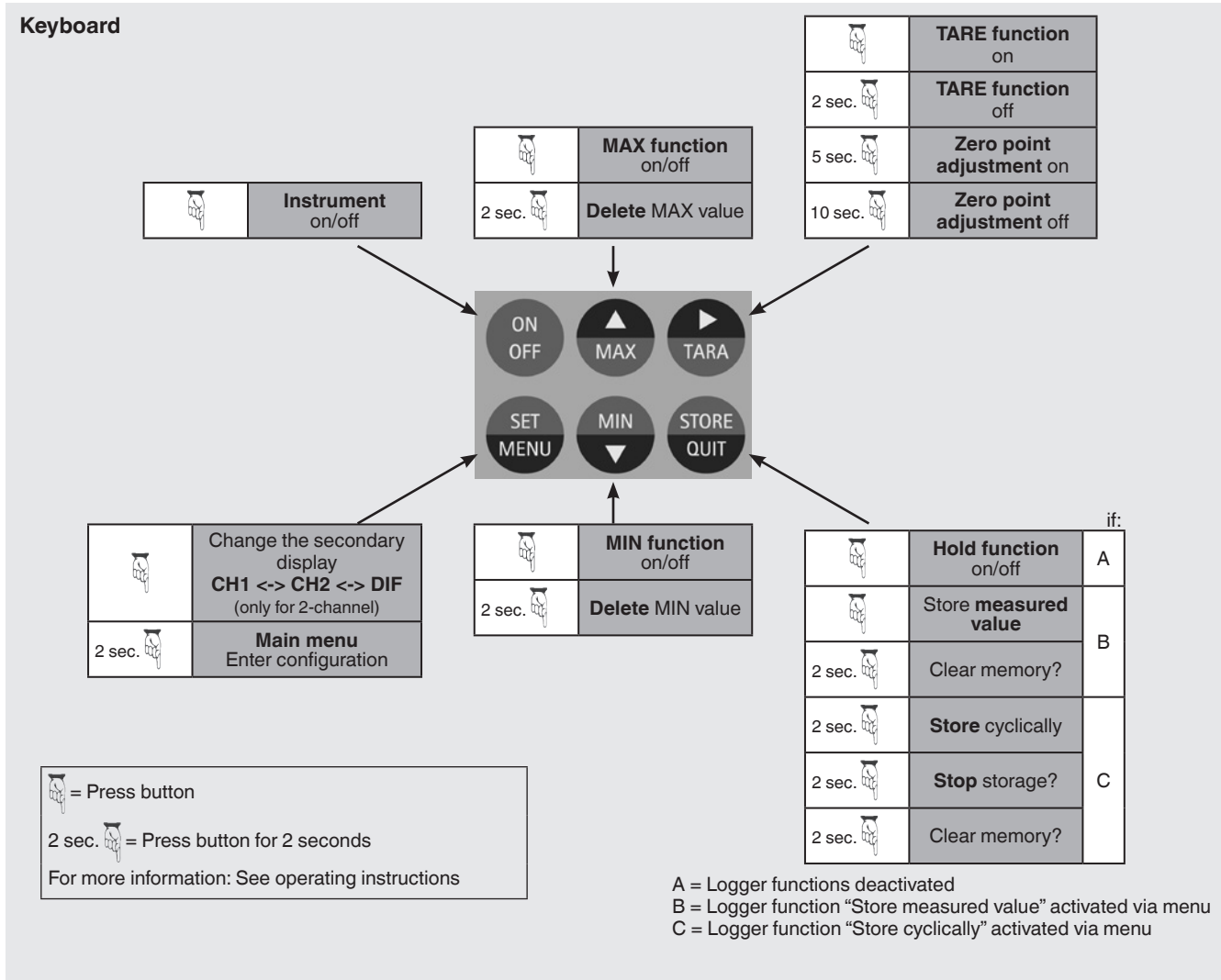

Complete test and service cases

The available test and service cases are individually equipped according to your needs.

A distinction is made between 5 different variants, which differ in the case size and the number or size of the recesses.

Case variants and existing recesses	1 ¹⁾	2	3	4	5
Recesses for standard components					
Hand-held pressure indicator, either model CPH6200-S1 or CPH6200-S2	x	x	x	x	x
Sensor connection cable 1.1 m (3.3 ft)	x	x	x	x	x
9 V battery	x	x	x	x	x
Sealing set	x	x	x	x	x
Number of freely selectable reference pressure sensors, model CPT6200	3	5	5	5	5
Pneumatic hand test pump, either model CPP30 or CPP7-H		x			
Hydraulic hand test pump, either model CPP700-H or CPP1000-H			x		
Hydraulic hand spindle pump model CPP1000-L				x	
Hand-held temperature measuring instrument, model CTH6200					x
Number of freely selectable temperature probes, model CTP62x0					2
Recesses for additional accessories					
Sensor extension cable 3.8 m (12.5 ft)	x	x	x	x	x
9 V rechargeable battery and charger	x	x	x	x	x
Power supply unit	x	x	x	x	x
Interface cable	x	x	x	x	x
GSoft data logger evaluation software	x	x	x	x	x
USB dongle for WIKA-Cal calibration software	x	x	x	x	x

1) Due to its size, this case model may not provide enough space for all available accessories. We will be happy to help you choose the best equipment for your case set.

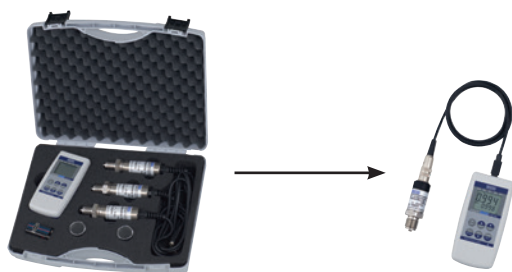

Variant 1: Calibration case with max. 3 pressure sensors

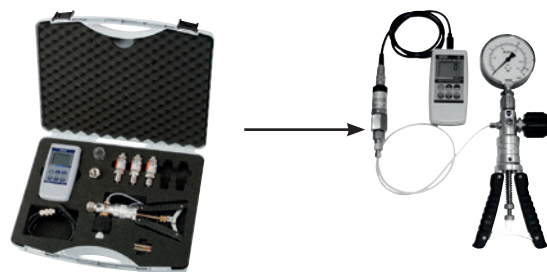

Variant 2 or 3: Calibration case with max. 5 pressure sensors incl. hand test pump

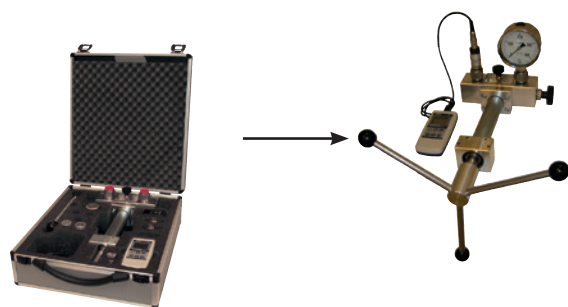

Variant 4: Calibration case with max. 5 pressure sensors incl. hand spindle pump



Variant 5: Calibration case with two hand-helds (pressure and/or temperature) and matching accessories

GSoft data logger evaluation software

The GSoft data logger evaluation software is used to display the logger data of the model CPH6200 hand-held pressure indicator on a PC in tabular form and as chart.

- Easy operation with self-explanatory toolbars
- Data from the pressure and temperature hand-helds (CPH6200) can be displayed in a single chart (two separate y-axes)
- Chart offers a zoom function
- Operation of the logger function via PC (remote control)
- Data can be exported (Excel®, etc.)
- Languages: German, English, French, Spanish and Czech

System requirements, GSoft version 3.2

- IBM compatible PC (Pentium®)
- At least 20 MB free hard disc space
- CD-ROM drive
- At least 32 MB RAM
- Windows® operating system 95, 98, NT 4.0 (with Service Pack 3.0 or higher), 2000, XP, Vista 7, 8, 8.1 or 10
- Mouse
- USB port (via interface cable)

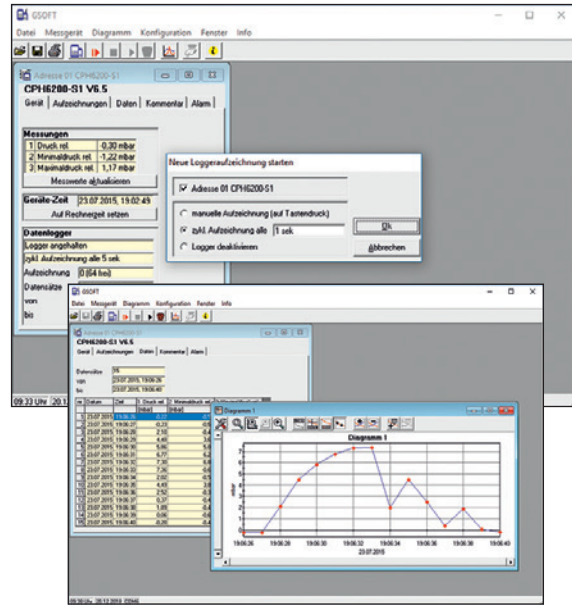

Data export e.g. in an Excel® file

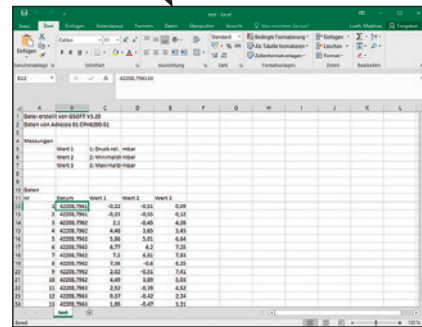

Windows® is a registered trademark of Microsoft Corporation in the United States and other countries.

Easy operation with self-explanatory icon buttons

Main toolbar

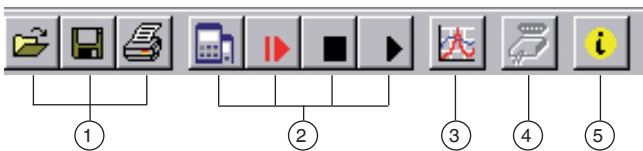

- ① File functions: Open, save, print
- ② Logger functions: Start communication, start logger, stop, read data
- ③ Data display: Create chart
- ④ Interface configuration
- ⑤ Program information
- ⑥ Settings: Grid and colour settings, manual zooms

Charts toolbar

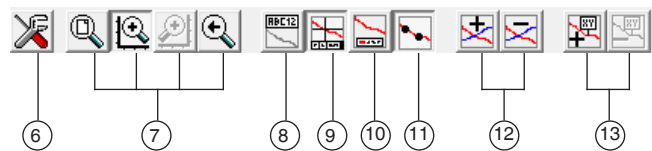

- ⑦ Zoom: All, left or right y-axis (via mouse), back
- ⑧ Rename chart
- ⑨ Cursor on/off (info footer)
- ⑩ Legend on/off
- ⑪ (Measuring point) Symbols on/off
- ⑫ Measurement series (add/delete)
- ⑬ Comments on measuring points (add/delete)

WIKA-Cal calibration software

Easy and fast creation of a high-quality calibration certificate

The WIKA-Cal calibration software is used for generating calibration certificates or logger protocols for pressure measuring instruments and is available as a demo version for a cost-free download.

To switch from the demo version to a licenced version, a USB dongle with a valid licence must be purchased.

The preinstalled demo version changes automatically to the selected version when plugging in the USB dongle and remains available as long as the USB dongle is connected to the PC.



- The user is guided through the calibration or logger process
- Management of calibration data and instrument data
- Intelligent preselection via SQL database
- Menu languages: German, English, Italian, French, Dutch, Polish, Portuguese, Romanian, Spanish Swedish, Russian, Greek, Japanese, Chinese
More languages are due with software updates
- Customer-specific complete solutions possible

The supported instruments are continuously expanded and even customer-specific adaptations are possible.

For further information, see data sheet CT 95.10











Two WIKA-Cal licences are available together with one hand-held



The WIKA-Cal calibration software is available both for reading the logger data stored in the hand-held as well as for online calibrations together with a PC. The scope of software functions depends on the selected licence.

Several licences can be combined on one USB dongle.

Cal-Template (demo version)	Cal-Template (light version)	Log-Template (full version)
Fully automatic calibration	Semi-automatic calibration	<ul style="list-style-type: none"> ■ Live measured value recording for a certain period of time with selectable interval, duration and start time ■ Readout of the integrated data logger of the hand-held ■ Creation of logger reports with graphic and/or tabular representation of the measurement results in PDF format ■ Export of measurement results as CSV file possible
Limitation to two measuring points	No limitation of the measuring points approached	
<ul style="list-style-type: none"> ■ Creation of 3.1 inspection certificates per DIN EN 10204 ■ Calibration data can be exported to Excel® template or XML file ■ Calibration of pressure measuring instruments 		
Ordering information for your enquiry:		
Is available for a cost-free download	WIKA-CAL-LZ-Z-Z	WIKA-CAL-ZZ-L-Z
	WIKA-CAL-LZ-L-Z	

Accessories

Description		Order code
	9 V battery	-B-
	9 V rechargeable battery	-A-
	Charger for 9 V rechargeable battery and 2 rechargeable AAA batteries Euro standard	-1-
	UK standard	-2-
	US standard	-3-
	Power supply unit Euro standard	-4-
	UK standard	-5-
	US standard	-6-
	Sealing set Consisting of 4 x G ½ USIT seals, 2 x G ¼ USIT seals and plastic box	-D-
	Plastic case Variant 1 For 1 x hand-held, max. 3 x pressure sensors, accessories Dimensions: 340 x 275 x 83 mm (13.39 x 10.83 x 3.27 in)	-K-
	Variant 2 For 1 x hand-held, max. 5 x pressure sensors, 1 x pneumatic hand test pump model CPP7-H or model CPP30 and accessories Dimensions: 450 x 360 x 123 mm [17.72 x 13.78 x 4.84 in]	-L-
	Variant 3 For 1 x hand-held, max. 5 x pressure sensors, 1 x hydraulic hand test pump model CPP700-H or model CPP1000-H and accessories Dimensions: 450 x 360 x 140 mm [17.72 x 13.78 x 5.51 in]	-N-
	Transport case from aluminium Variant 4 For 1 x hand-held, max. 5 x pressure sensors, 1 x hydraulic hand spindle pump model CPP1000-L and accessories Dimensions: 375 x 425 x 170 mm [14.76 x 16.73 x 6.69 in]	-M-
	Variant 5 For 2 x hand-held pressure and/or temperature, max. 5 x pressure sensors, max. 2 x temperature probes, accessories Dimensions: 450 x 345 x 145 mm (17.72 x 13.58 x 5.71 in)	-O-
	Cable Sensor connection cable Length: Approx. 1.1 m [3.3 ft]	-S-
	Extension cable for connection of sensors Length: Approx. 3.8 m [12.5 ft] to approx. 5 m [16.4 ft]	-V-
	2-core connection cable with loose ends (end splices) for connecting the configurable analogue output Length: Approx. 2 m [6.6 ft]	-E-
	Interface cable For RS-232 interfaces	-R-

Description		Order code
		CPH-A-62-
	Interface cable For USB interfaces	-U-
	GSoft data logger evaluation software	-G-
Ordering information for your enquiry:		
1. Order code: CPH-A-62 2. Option:		↓ []

Scope of delivery

- Hand-held pressure indicator model CPH6200
- 9 V battery
- One sensor connection cable per channel
- Calibration certificate for sensors
- Optional CPT6200 reference pressure sensors (must be ordered separately)



Model CPH6200-S2 hand-held pressure indicator with two external model CPT6200 reference pressure sensors

Ordering information

CPH6200 / Instrument version / Additional cable for reference pressure sensor / Power supply unit / Rechargeable battery and battery charger / Software / Interface cable / Test pump / Transport case / Further approvals / Additional ordering information

CPT6200 / Unit / Measuring range / Accuracy / Process connection / Special design features / Type of certificate / Pressure adapter / Further approvals / Additional ordering information

© 02/2003 WIKA Alexander Wiegand SE & Co. KG, all rights reserved.
The specifications given in this document represent the state of engineering at the time of publishing.
We reserve the right to make modifications to the specifications and materials.