

Intrinsically safe hand-held pressure indicator

Model CPH6210-S1 (1-channel version)

Model CPH6210-S2 (2-channel version)

WIKA data sheet CT 11.02



for further approvals
see page 5

Applications

- Calibration service companies and service industry
- Measurement and control laboratories
- Pressure tests

Special features

- Intrinsically safe indicator with interchangeable pressure sensors model CPT6210 (plug-and-play)
- Measuring ranges 0 ... 1,000 bar [0 ... 14,500 psi]
- Type of pressure: Positive and negative overpressure, absolute pressure and differential pressure
- Accuracy: 0.2 %, optionally 0.1 % (incl. calibration certificate)
- Data logger for recording measured values



Hand-held pressure indicator model CPH6210-S1 with external reference pressure sensor model CPT6210

Description

Extensive application possibilities

For the hand-held pressure indicator model CPH6210, external reference pressure sensors of model CPT6210 with measuring ranges of up to 1,000 bar [14,500 psi] are available. It is therefore particularly suitable as a test instrument for applications such as process engineering, chemical industry, refineries, etc. The digital indicator automatically detects the measuring range of the connected pressure sensor and guarantees a highly accurate pressure measurement.

Functionality

The CPH6210 can be used for measuring both gauge and absolute pressure. Differential pressure measurement is possible with the 2-channel version CPH6210-S2, and two connected model CPT6210 reference pressure sensors. Pressure units selectable on the instrument are: bar, mbar, psi, Pa, kPa, MPa, mmHg or inHg.

An integrated data logger and various other functions such as Min., Max., Hold, Tare, zero point adjustment, alarm, power-off, peak value detection (1,000 measurements/s), mean value filter, etc. ensure that the CPH6210 can be used for many different applications.

Software

In addition to the GSoft data logger evaluation software for the tabular and graphical representation of the logger data, WIKA-Cal calibration software for calibration tasks is also available. WIKA-Cal also offers, over and above PC-supported calibration, the management of the calibration and instrument data in an SQL database. A USB interface is available for the data transfer.

Complete test and service cases

For maintenance and service applications, various case systems are available. These include service cases with or without pressure generation, battery, connection adapter, etc.

Certified accuracy

For each reference pressure sensor, the accuracy for the complete measuring chain is certified by a factory calibration certificate which accompanies the instrument. On request, we can provide a DKD/DAkkS calibration certificate for this instrument.

Specifications

Model CPH6210 hand-held pressure indicator	
Electrical connection for reference pressure sensor	
Measuring inputs	<ul style="list-style-type: none">■ 1 input for CPH6210-S1■ 2 inputs for CPH6210-S2
Sensor compatibility	Compatible with model CPT6210 reference pressure sensors
Connection to CPH6210	6-pin, shielded mini DIN female connector with interlocking
Sensor connection cable	Standard: Cable with 6-pin mini DIN connector and 7-pin bayonet connector, length 1.1 m [3.3 ft] Option: Extension cable, length 3.8 m [12.5 ft], overall cable length approx. 5 m [16.4 ft]
Indication	
Display	Large 4 1/2-digit LC display for indication of two pressure values and additional information
Indication range	-19999 ... 19999 digits (dependent upon connected reference pressure sensor)
Pressure types	Dependent upon connected reference pressure sensor <ul style="list-style-type: none">■ Gauge pressure, absolute pressure or vacuum■ Differential pressure measurement only with CPH6210-S2, and two model CPT6210 reference pressure sensors connected
Pressure units	Freely selectable depending on the measuring range <ul style="list-style-type: none">■ bar■ mbar■ psi■ Pa■ kPa■ MPa■ mmHg■ inHg
Functions	
Measuring rate	Measuring rate (can be set via menu) <ul style="list-style-type: none">■ 4/s ("Slo" - slow measurement)■ 1,000/s filtered ("Fast" - fast measurement)■ > 1,000/s unfiltered ("P.det" - peak value detection)
Mean value filter	1 ... 120 seconds (can be set via menu)
Data logger	<ul style="list-style-type: none">■ Individual value logger<ul style="list-style-type: none">⇒ Up to 99 recordings incl. time can be accessed via function button■ Cyclic logger<ul style="list-style-type: none">⇒ automatic recording of up to 10,000 values incl. time⇒ Cycle time freely adjustable in the range from 1 ... 3,600 seconds
Real-time clock	for data logger, (can be set via menu)
Min./Max. memory	Minimum or maximum measured value (can be accessed via function button)
Hold	Holding the last measured value (can be accessed via function button)
Tare	Tare or zero point correction (can be accessed via function button)
Alarm	Alarm function (can be set via menu) ⇒ Min./Max. alarm (audible/visual)
Sea level (barometric pressure)	Sea level adjustment -200 ... +9999 m (can be set via menu)
Power-off function	Automatic switch-off (can be set via menu) <ul style="list-style-type: none">■ activated (1 ... 120 minutes)■ deactivated (no automatic switch-off of the instrument)

Model CPH6210 hand-held pressure indicator	
Voltage supply	
Supply voltage	9 V battery
Battery life	> 300 hours of operation (1 sensor with a measuring rate of 4/s)
Permissible ambient conditions	
Operating temperature	-10 ... +50 °C [14 ... 122 °F]
Storage temperature	-20 ... +70 °C [-4 ... +158 °F]
Relative humidity	0 ... 95 % r. h. (non-condensing)
Output signals/interfaces	
Serial interface ¹⁾	RS-232 or USB (instrument-specific interface cable required)
Analogue output ¹⁾	DC 0 ... 1 V; configurable (can be activated via menu as an alternative to the serial interface, instrument-specific connection cable required)
Connection	Stereo jack connector, 3.5 mm
Case	
Material	impact-resistant ABS plastic, membrane keyboard, transparent screen, leather case
Dimensions	See technical drawing
Weight	approx. 160 g [0.35 lbs] (incl. battery)

Reference pressure sensor model CPT6210						
Measuring range						
Gauge pressure	bar	-0.6 ... 0 ²⁾	-0.4 ... 0 ²⁾	-0.25 ... 0 ²⁾	-1 ... 0 ²⁾	-0.1 ... +0.1
		-0.25 ... +0.25 ²⁾	-0.4 ... +0.4 ²⁾	-0.6 ... +0.6 ²⁾	-1 ... 1.5 ²⁾	-1 ... 3 ²⁾
		-1 ... 5 ²⁾	-1 ... 9 ²⁾	-1 ... 15 ²⁾	-1 ... 24 ²⁾	-1 ... 39 ²⁾
		0 ... 0.1 ²⁾	0 ... 0.16 ²⁾	0 ... 0.25	0 ... 0.4	0 ... 0.6
		0 ... 1	0 ... 1.6	0 ... 2.5	0 ... 4	0 ... 6
		0 ... 10	0 ... 16	0 ... 25	0 ... 40	0 ... 60
		0 ... 70	0 ... 100	0 ... 160	0 ... 250	0 ... 400
		0 ... 600	0 ... 1,000			
	psi	-15 ... 0 ²⁾	-15 ... +15 ²⁾	-15 ... +40 ²⁾	-15 ... +70 ²⁾	-15 ... +130 ²⁾
		-3 ... +3 ²⁾	-5 ... +5 ²⁾	-8 ... +8 ²⁾	-8 ... 0 ²⁾	-5 ... 0 ²⁾
		-3 ... 0 ²⁾	0 ... 5	0 ... 10	0 ... 15	0 ... 20
		0 ... 30	0 ... 50	0 ... 100	0 ... 150	0 ... 200
		0 ... 300	0 ... 500	0 ... 1,000	0 ... 1,500	0 ... 2,000
		0 ... 3,000	0 ... 6,000	0 ... 8,000	0 ... 14,500	
Absolute pressure ²⁾	bar abs.	0 ... 0.25	0 ... 0.4	0 ... 0.6	0 ... 1	0 ... 1.6
		0 ... 2.5	0 ... 4	0 ... 6	0 ... 10	
		0 ... 25				
	psi abs.	0 ... 5	0 ... 10	0 ... 15	0 ... 20	0 ... 30
		0 ... 50	0 ... 100	0 ... 150	0 ... 200	
Overpressure safety	3 times; ≤ 25 bar 2 times; > 25 bar ... ≤ 600 bar 1.5 times; > 600 bar			3 times; ≤ 360 psi 2 times; > 360 psi ... ≤ 8,700 psi 1.5 times; > 8,700 psi		

1) Only use outside the hazardous areas!
2) Not available as oxygen version.

Reference pressure sensor model CPT6210

Process connection

G ½ B	for all measuring ranges
G ½ B flush ³⁾	for measuring ranges > 1.6 ... < 1,000 bar and bar abs. for measuring ranges > 5 ... < 14,500 psi and psi abs.
G 1 B flush ³⁾	for measuring ranges ≥ 0.1 ... ≤ 1.6 bar and bar abs. for measuring ranges > 5 ... ≤ 20 psi and psi abs.
Adapters	various connection adapters on request

Material

Wetted parts	Measuring ranges ≥ 0.1 ... 25 bar [≥ 1.45 ... 360 psi] ■ Stainless steel or ■ Elgiloy [®]
	Measuring ranges > 25 bar [> 360 psi] ■ Stainless steel and sealing from NBR or ■ Elgiloy [®] and sealing from NBR
	Oxygen version, measuring ranges ≥ 0.25 bar [≥ 0.4 psi] ■ Stainless steel or ■ Elgiloy [®]
	Flush version ■ Stainless steel with O-ring from NBR or ■ Stainless steel with O-ring from EPDM or ■ Hastelloy C4 with O-ring from NBR or ■ Hastelloy C4 with O-ring from EPDM
Pressure transmission medium	for measuring ranges to ≤ 16 bar [≤ 250 psi] synthetic oil
	for flush version synthetic oil
	for oxygen version halocarbon oil

Permissible ambient conditions

Medium temperature	■ -20 ... +50 °C [-4 ... +122 °F] ■ -10 ... +50 °C [14 ... 122 °F] (only for oxygen version)
Operating temperature	-20 ... +50 °C [-4 ... +122 °F]
Storage temperature	-40 ... +80 °C [-40 ... +176 °F]
Relative humidity	0 ... 95 % r. h. (non-condensing)

Case

Material	Stainless steel
Ingress protection	■ IP65 ■ IP67 when connected
Dimensions	See technical drawing
Weight	approx. 220 g [0.49 lbs]
Accuracy of the measuring chain ⁴⁾	■ 0.2 % FS ■ 0.1 % FS at reference conditions ⁵⁾
Mean temperature coefficient	≤ 0.2 % of span/10 K (outside the reference conditions) ⁵⁾
Compensated range	0 ... 80 °C [0 ... 176 °F]

3) As an oxygen version or oil- and grease-free version, a flush version is not available.

4) It is defined by the total measurement uncertainty, which is expressed with the coverage factor (k = 2) and includes the following factors: the intrinsic performance of the instrument, the measurement uncertainty of the reference instrument, long-term stability, influence of ambient conditions, drift and temperature effects over the compensated range during a periodic zero point correction.

5) Reference conditions: 15 ... 25 °C [59 ... 77 °F]

Safety-related characteristic values







Model CPH6210 hand-held pressure indicator



Parameters	Connection values CPH6210
Max. output voltage	$U_o = DC\ 10.38\ V$
Max. output current	$I_o = 93\ mA$
Max. output power	$P_o = 240\ mW$
Max. internal capacitance	$C_o = 1,240\ nF$
Max. internal inductance	L_o negligible

Reference pressure sensor model CPT6210

Parameters	Power supply circuit CPT6210
Max. input voltage	$U_i = DC\ 10.4\ V$
Max. input current	$I_i = 100\ mA$
Max. input power	$P_i = 500\ mW$
Max. internal capacitance	$C_i = 600\ nF$
Max. internal inductance	L_i negligible

Approvals

Logo	Description	Country
 	EU declaration of conformity for CPH6210 <ul style="list-style-type: none"> ■ EMC directive EN 61326 emission (group 1, class B) and immunity (portable equipment) ■ RoHS directive ■ ATEX directive Hazardous areas - Ex i Zone 1 gas II 2G Ex ib IIC T4 (Ta = -10 ... +50 °C) BUREAU VERITAS EPS 09 ATEX 1 227 X 	European Union
 	EU declaration of conformity for CPT6210 <ul style="list-style-type: none"> ■ EMC directive EN 61326 emission (group 1, class B) and immunity (portable equipment) ■ Pressure equipment directive PS > 200 bar; module A, pressure accessory ■ RoHS directive ■ ATEX directive Hazardous areas - Ex i Zone 1 gas II 2G Ex ib IIC T4 (Ta = -20 ... +50 °C) II 2G Ex ib IIC T4 Gb (Ta = -20 ... +50 °C) DEKRA BVS 10 ATEX E 150 X 	European Union
	EAC (option) <ul style="list-style-type: none"> ■ Import certificate ■ EMC directive 	Eurasian Economic Community
	GOST (option) Metrology, measurement technology	Russia
	KazInMetr (option) Metrology, measurement technology	Kazakhstan
-	MTSCHS (option) Permission for commissioning	Kazakhstan

Logo	Description	Country
	BelGIM (option) Metrology, measurement technology	Belarus
	UkrSEPRO (option) Metrology, measurement technology	Ukraine
	Uzstandard (option) Metrology, measurement technology	Uzbekistan
-	CPA (option) Metrology, measurement technology	China

Certificates

Certificate	
Calibration	Standard: 3.1 calibration certificate per DIN EN 10204 Option: DKD/DAkkS calibration certificate
Recommended recalibration interval	1 year (dependent on conditions of use)

Approvals and certificates, see website

Electrical connections

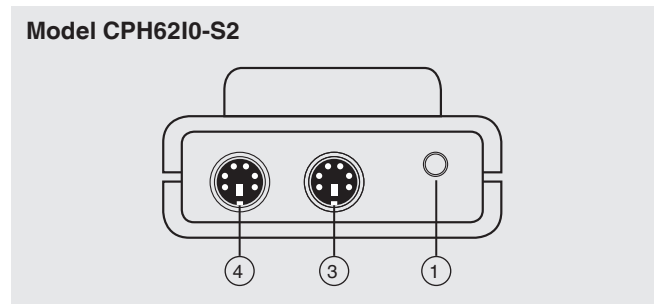
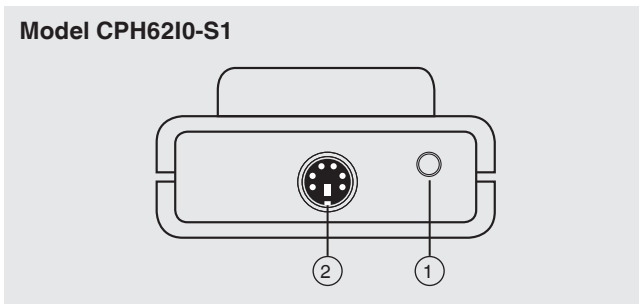

- ① Interface connector or optional analogue output
- ② Connection channel 1 (only with CPH62I0-S1)
- ③ Connection channel 2 (only with CPH62I0-S2)
- ④ Connection channel 1 (only with CPH62I0-S2)

Dimensions in mm [in]

Digital indicator CPH6210-S1

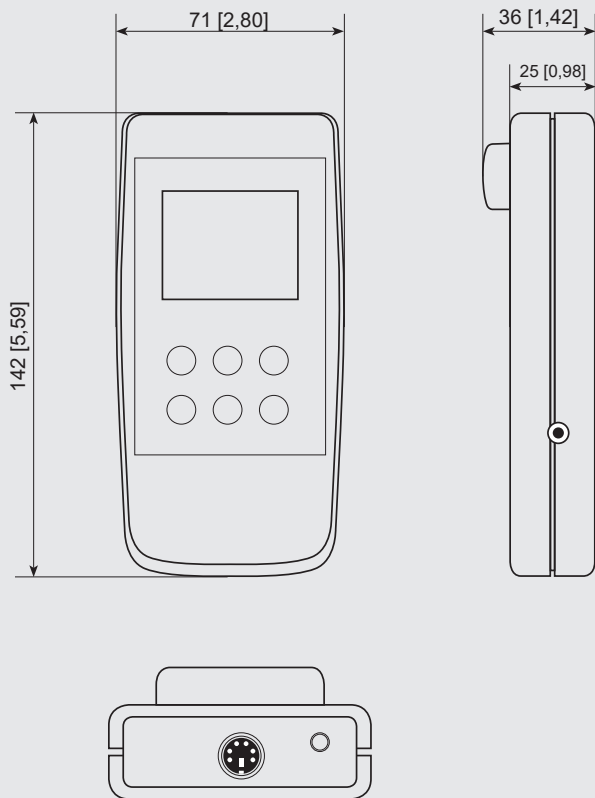

Digital indicator CPH6210-S2

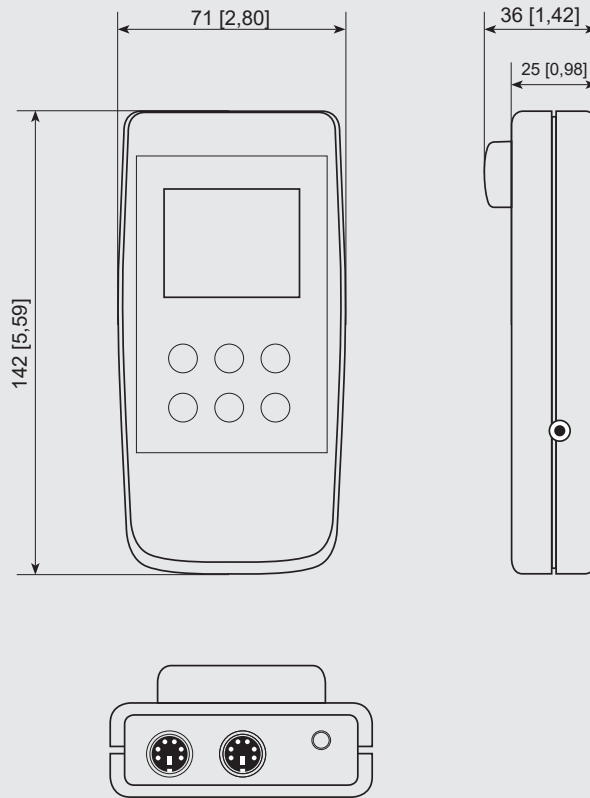

Note: The CPH6210 intrinsically safe version is in a protective leather case (Ex protective cover).

For the CPH6210 intrinsically safe version, the use of the interface and power supply unit is only permitted outside the hazardous area. The interface connector is located below the Ex protective cover.

CPT6210 reference pressure sensor

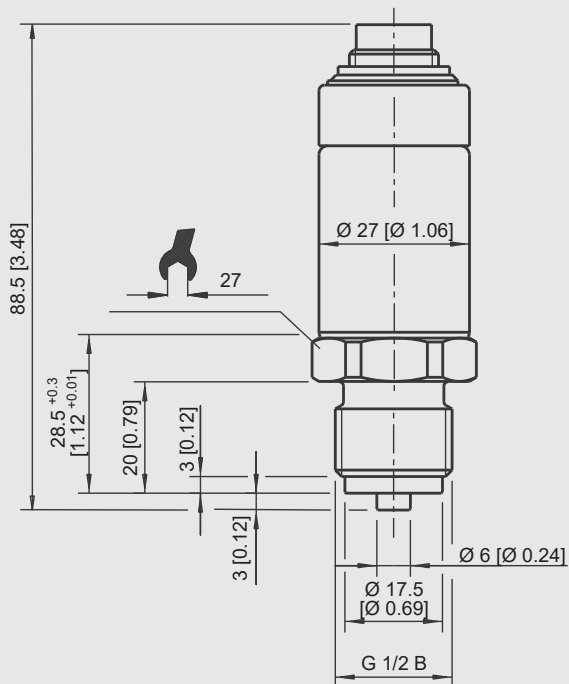

Operating functions of the models CPH6210-S1 and CPH6210-S2

1- and 2-channel version with external pressure sensors

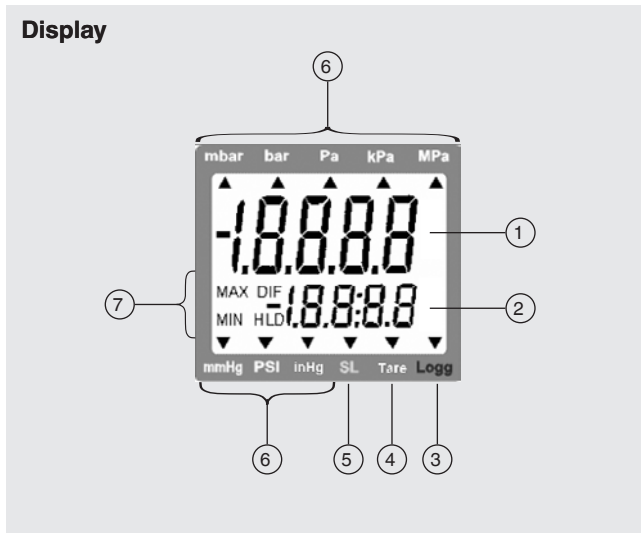

- ① **Main display:** Current measured value for sensor 1
- ② **Secondary display:** Current measured value for sensor 2 or differential value between sensor 1 and sensor 2
- ③ **Logg arrow:** Logger is ready
Arrow blinking: Automatic recording (Logg CYCL) active
- ④ **Tare arrow:** Tare function was activated
- ⑤ **SL arrow:** Altitude correction (sea level) was activated
- ⑥ Display arrows for **measured value units**
- ⑦ Indicating elements for Min./Max. measured value illustration

Keyboard

	Instrument on/off
--	-----------------------------

	MAX function on/off
2 sec.	Delete MAX value

	TARE function on
2 sec.	TARE function off
5 sec.	Zero point adjustment on
10 sec.	Zero point adjustment off

ON	▲	▶
OFF	MAX	TARA
SET	▼	▶
MENU	MIN	STORE
		QUIT

	Change the secondary display CH1 <-> CH2 <-> DIF (only for 2-channel)
2 sec.	Main menu Enter configuration

	MIN function on/off
2 sec.	Delete MIN value

	Hold function on/off	A
	Store measured value	B
2 sec.	Clear memory?	C
2 sec.	Store cyclically	
2 sec.	Stop storage?	
2 sec.	Clear memory?	

= Press button

2 sec. = Press button for 2 seconds

For more information: See operating instructions

A = Logger functions deactivated

B = Logger function "Store measured value" activated via menu

C = Logger function "Store cyclically" activated via menu

GSoft data logger evaluation software

The GSoft data logger evaluation software is used to display the logger data of the model CPH6210 hand-held pressure indicator on a PC in tabular form and as chart.

- Easy operation with self-explanatory toolbars
- Data from the pressure and temperature hand-helds (CTH) can be displayed in a single chart (two separate y-axes)
- Chart offers a zoom function
- Operation of the logger function via PC (remote control)
- Data can be exported (Excel®, etc.)
- Languages: German, English, French, Spanish and Czech

System requirements, GSoft version 3.2

- IBM compatible PC (Pentium®)
- At least 20 MB free hard disc space
- CD-ROM drive
- At least 32 MB RAM
- Windows® operating system 95, 98, NT 4.0 (with Service Pack 3.0 or higher), 2000, XP, Vista 7, 8, 8.1 or 10
- Mouse
- USB port (via interface cable)

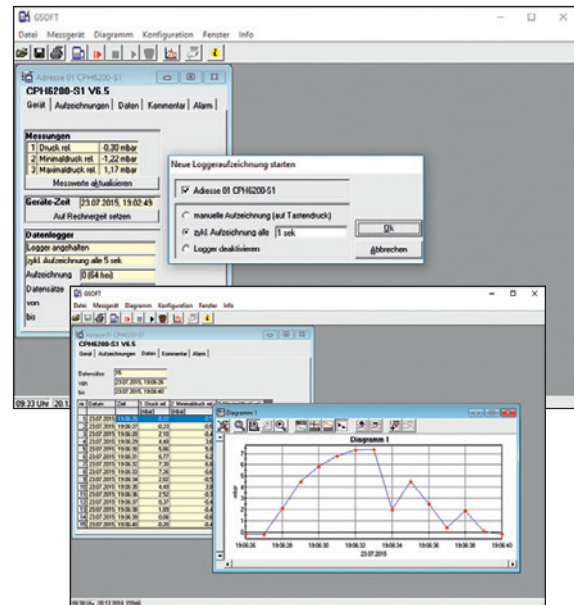

Data export e.g. in an Excel® file

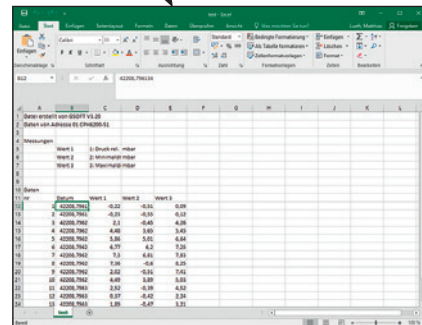

Windows® is a registered trademark of Microsoft Corporation in the United States and other countries.

Easy operation with self-explanatory icon buttons

Main toolbar

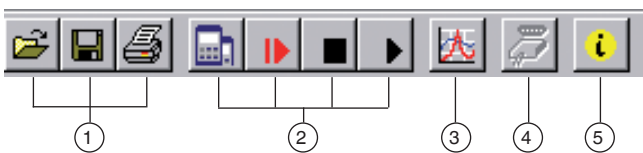

- ① File functions: Open, save, print
- ② Logger functions: Start communication, start logger, stop, read data
- ③ Data display: Create chart
- ④ Interface configuration
- ⑤ Program information
- ⑥ Settings: Grid and colour settings, manual zooms

Charts toolbar

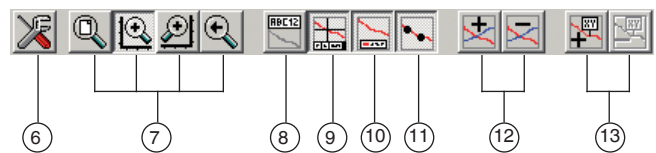

- ⑦ Zoom: All, left or right y-axis (via mouse), back
- ⑧ Rename chart
- ⑨ Cursor on/off (info footer)
- ⑩ Legend on/off
- ⑪ (Measuring point) Symbols on/off
- ⑫ Measurement series (add/delete)
- ⑬ Comments on measuring points (add/delete)

WIKA-Cal calibration software

Easy and fast creation of a high-quality calibration certificate

WIKA-Cal calibration software serves for the creation of calibration certificates or logger protocols for pressure measuring instruments. A demo version is available for free download.

To switch from the demo version to a licenced version, a USB dongle with a valid licence must be purchased.

The pre-installed demo version changes automatically to the selected version when plugging in the USB dongle and remains available as long as the USB dongle is connected to the PC.



- The user is guided through the calibration or logger process
- Management of calibration data and instrument data
- Intelligent preselection via SQL database
- Menu languages: German, English, Italian, French, Dutch, Polish, Portuguese, Romanian, Spanish, Swedish, Russian, Greek, Japanese, Chinese
More languages will be due with software updates
- Customer-specific complete solutions possible
- Maximum degree of automation in connection with our CPC series

The supported instruments are continuously expanded and even customer-specific adaptations are possible.

For further information see data sheet CT 95.10

Two WIKA-Cal licences are available together with one hand-held

The WIKA-Cal calibration software is available both for reading the logger data stored in the hand-held as well as for online calibrations together with a PC. The scope of software functions depends on the selected licence. Several licences can be combined on one USB dongle.

Cal-Template (light version)	Log-Template (full version)
<ul style="list-style-type: none"> ■ Semi-automated creation of calibration certificates for mechanical and electronic pressure measuring instruments ■ Creation of calibration certificates 3.1 per DIN EN 10204 ■ Calibration reports can be exported to Excel® template or XML file 	<ul style="list-style-type: none"> ■ Live measurement recording for a certain period of time with selectable interval, duration and start time ■ Readout of the integrated data logger of the hand-held ■ Creation of logger protocols with graphic and/or tabular representation of the measurement results in PDF format ■ Possibility of exporting measurement results as a CSV file
Ordering information for your enquiry:	
WIKA-CAL-LZ-Z-Z	WIKA-CAL-ZZ-L-Z
WIKA-CAL-LZ-L-Z	

Complete test and service cases

The available test and service cases are individually equipped according to your needs.

A distinction is made between 5 different variants, which differ in the case size and the number or size of the recesses.

Case variants and existing recesses	1 ¹⁾	2	3	4
Recesses for standard components				
Hand-held pressure indicator, either model CPH6210-S1 or CPH6210-S2	x	x	x	x
Sensor connection cable 1.1 m [3.3 ft]	x	x	x	x
9 V battery	x	x	x	x
Sealing set	x	x	x	x
Number of freely selectable reference pressure sensors, model CPT6210	3	5	5	5
Pneumatic hand test pump model CPP30		x		
Hydraulic hand test pump, either model CPP700-H or CPP1000-H			x	
Hydraulic hand spindle pump model CPP1000-L				x
Recesses for additional accessories				
Sensor extension cable 3.8 m [12.5 ft]	x	x	x	x
Interface cable	x	x	x	x
GSoft data logger evaluation software	x	x	x	x
USB dongle for WIKA-Cal calibration software	x	x	x	x

1) Due to its size, this case model may not provide enough space for all available accessories. We will be happy to help you choose the best equipment for your case set.

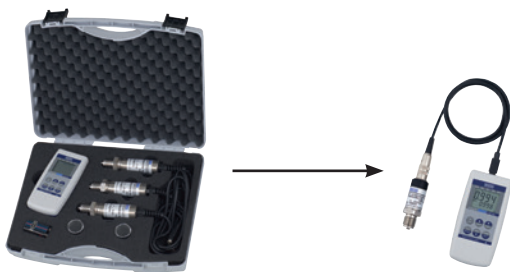

Variant 1: Calibration case with max. 3 pressure sensors

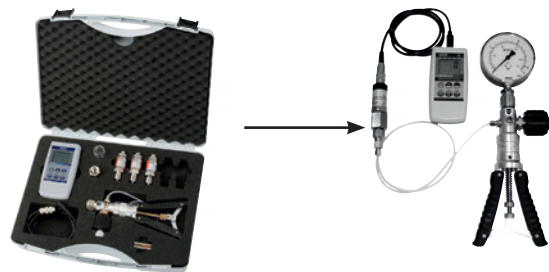



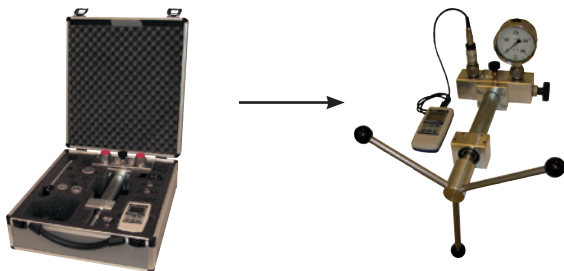





Variant 2 or 3: Calibration case with max. 5 pressure sensors and incl. hand test pump



Variant 4: Calibration case with max. 5 pressure sensors and incl. hand spindle pump

Accessories

Description	Order code
	<p>9 V battery</p> <p>-B-</p>
	<p>Sealing set Consisting of 4 x G ½ USIT seals, 2 x G ¼ USIT seals and plastic box</p> <p>-D-</p>
	<p>Plastic case Variant 1 for 1 x hand-held, max. 3 x pressure sensors, accessories Dimensions: 340 x 275 x 83 mm [13.39 x 10.83 x 3.27 in]</p> <p>⚠ May not be used in Ex areas!</p> <p>Variant 2 for 1 x hand-held, max. 5 x pressure sensors, 1 x pneumatic hand test pump model CPP30, accessories Dimensions: 450 x 360 x 123 mm [17.72 x 13.78 x 4.84 in]</p> <p>⚠ May not be used in Ex areas!</p> <p>Variant 3 for 1 x hand-held, max. 4 x pressure sensors, 1 x hydraulic hand test pump model CPP700-H/ CPP1000-H, accessories Dimensions: 450 x 360 x 140 mm [17.72 x 13.78 x 5.51 in]</p> <p>⚠ May not be used in Ex areas!</p> <p>-K- -L- -N-</p>
	<p>Transport case from aluminium Variant 4 for 1 x hand-held, max. 5 x pressure sensors, 1 x hydraulic hand spindle pump model CPP1000-L, accessories Dimensions: 375 x 425 x 170 mm [14.76 x 16.73 x 6.69 in]</p> <p>⚠ May not be used in Ex areas!</p> <p>-M-</p>
	<p>Sensor connection cable approx. 1.1 m [3.3 ft]</p> <p>⚠ Ex version!</p> <p>-S-</p>
	<p>Extension cable for connection of sensors, approx. 3.8 m [12.5 ft] to approx. 5 m [16.4 ft]</p> <p>⚠ Ex version!</p> <p>-V-</p>
	<p>Interface cable for RS-232 interfaces</p> <p>⚠ May not be used in Ex areas!</p> <p>-R-</p>
	<p>Interface cable for USB interfaces</p> <p>⚠ May not be used in Ex areas!</p> <p>-U-</p>

Description		Order code
		CPH-A-6I-
	GSoft data logger evaluation software	-G-
Ordering information for your enquiry:		
1. Order code: CPH-A-6I 2. Option:		↓ []

Scope of delivery

- Hand-held pressure indicator model CPH62I0-S1, incl. 9 V battery
- One sensor connection cable per channel
- 3.1 calibration certificate per DIN EN 10204
- Optional CPT62I0 reference pressure sensors (must be ordered separately)

Options

- Hand-held pressure indicator model CPH62I0-S2: 2-channel version (differential pressure measurement possible via 2 connected model CPT62I0 reference pressure sensors)
- DKD/DAkkS calibration certificate
- Sensors for oxygen applications



Hand-held pressure indicator model CPH62I0-S2 with two external reference pressure sensors model CPT62I0

Ordering information

CPH62I0 / Instrument version / Additional cable for reference pressure sensor / Software / Interface cable / Test pump / Transport case / Further approvals / Additional ordering information

CPT62I0 / Unit / Measuring range / Accuracy / Process connection / Special design features / Type of certificate / Pressure adapter / Further approvals / Additional ordering information

© 04/2007 WIKA Alexander Wiegand SE & Co. KG, all rights reserved.
The specifications given in this document represent the state of engineering at the time of publishing.
We reserve the right to make modifications to the specifications and materials.