

Hydraulic comparison test pump Model CPP7000-X

WIKA data sheet CT 91.13



for further approvals
see page 2

Applications

- Calibration service companies and service industry
- Maintenance and service facilities
- For the testing, adjustment and calibration of all types of pressure measuring instruments
- Hydraulic pressure generation up to 7,000 bar (100,000 psi)

Special features

- Ergonomic handling through the smooth-running, internally operating, precision spindle
- Integrated oil reservoir
- Removable star handle
- Freely rotating test connections (i.e. measuring instruments can be aligned)
- Integrated priming pump for large test volumes

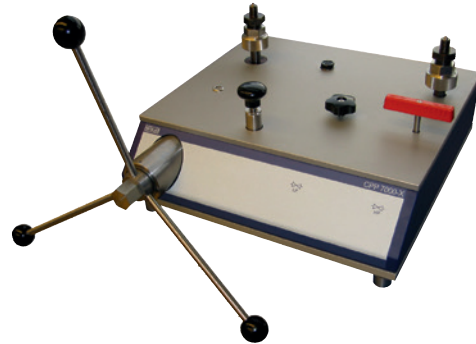

Comparison test pump, model CPP7000-X

Description

Application areas

The CPP7000-X comparison test pump serves as pressure generator for the testing, adjustment and calibration of mechanical and electronic pressure measuring instruments through comparative measurements. These pressure tests may be carried out in the laboratory, workshop, or on site at the measuring point.

Easy handling

For a precise approach to the measuring points, the comparison test pump is fitted with a spindle for fine control. In particular, the smooth running of the hand spindle enables this, even at very high pressures. The CPP7000-X is further characterised by the spindle which runs solely within the pump body. This eliminates an unfavourable bending moment on a spindle that has been unscrewed. This also has the

advantage that the dimensions of this pump do not change during operation due to spindle rotation.

With the comparison test pump, large test volumes can be easily filled and primed with the integrated priming pump.

Easy operation

If one connects the test item and a sufficiently accurate reference measuring instrument to the test pump, on actuating the pump, the same pressure will act on both instruments. By comparison of the two measured values at any given pressure value, a check of the accuracy and/or adjustment of the pressure measuring instrument under test can be carried out.



The model CPP7000-X comparison test pump is built in a solid base with high durability and, with the proven technology of the CPB5000HP pressure balance, offers exceptional ease-of-use. With the integrated priming pump and the 250 ml tank, large test volumes can also be easily filled and primed.

Both test connections are fitted with knurled nuts and exchangeable thread adapters with sealing cones (as standard M16 x 1.5 male). Corresponding thread adapters are available for the calibration of instruments with different connection threads.

Specifications

CPP7000-X	
Pressure range	0 ... 7,000 bar (0 ... 100,000 psi)
Pressure transmission medium	Sebacate oil
Reservoir	250 cm ³
Pressure connections	
Test connection	2 x knurled nut G 3/4 female, freely rotating with sealing cone, incl. interchangeable adapter to M16 x 1.5 male with sealing cone
Distance between test connections	346 mm (13.6 in)
Piston of the comparison test pump	
Piston diameter	7.5 mm (0.3 in)
Displacement per revolution	approx. 0.08 cm ³
Overall displacement	approx. 2.5 cm ³
Material	
Cylinder	Stainless steel
Piston	hardened stainless steel
Piping	1.4404 stainless steel, 6 x 2 mm (0.2 x 0.1 in)
Sealings	NBR
Permissible operating temperature	18 ... 28 °C (64 ... 82 °F)
Instrument base	
Stationary mounting	Stable base
Dimensions (L x W x H)	460 x 445 x 265 mm (18.1 x 17.5 x 10.4 in)
Weight	32.5 kg (71.7 lbs.)

Approvals

Logo	Description	Country
	EU declaration of conformity Pressure equipment directive (PS > 200 bar; module A, pressure accessory)	European Union
	EAC Machinery directive	Eurasian Economic Community
-	MTSCHS Permission for commissioning	Kazakhstan

Approvals and certificates, see website

Dimensions in mm (in)

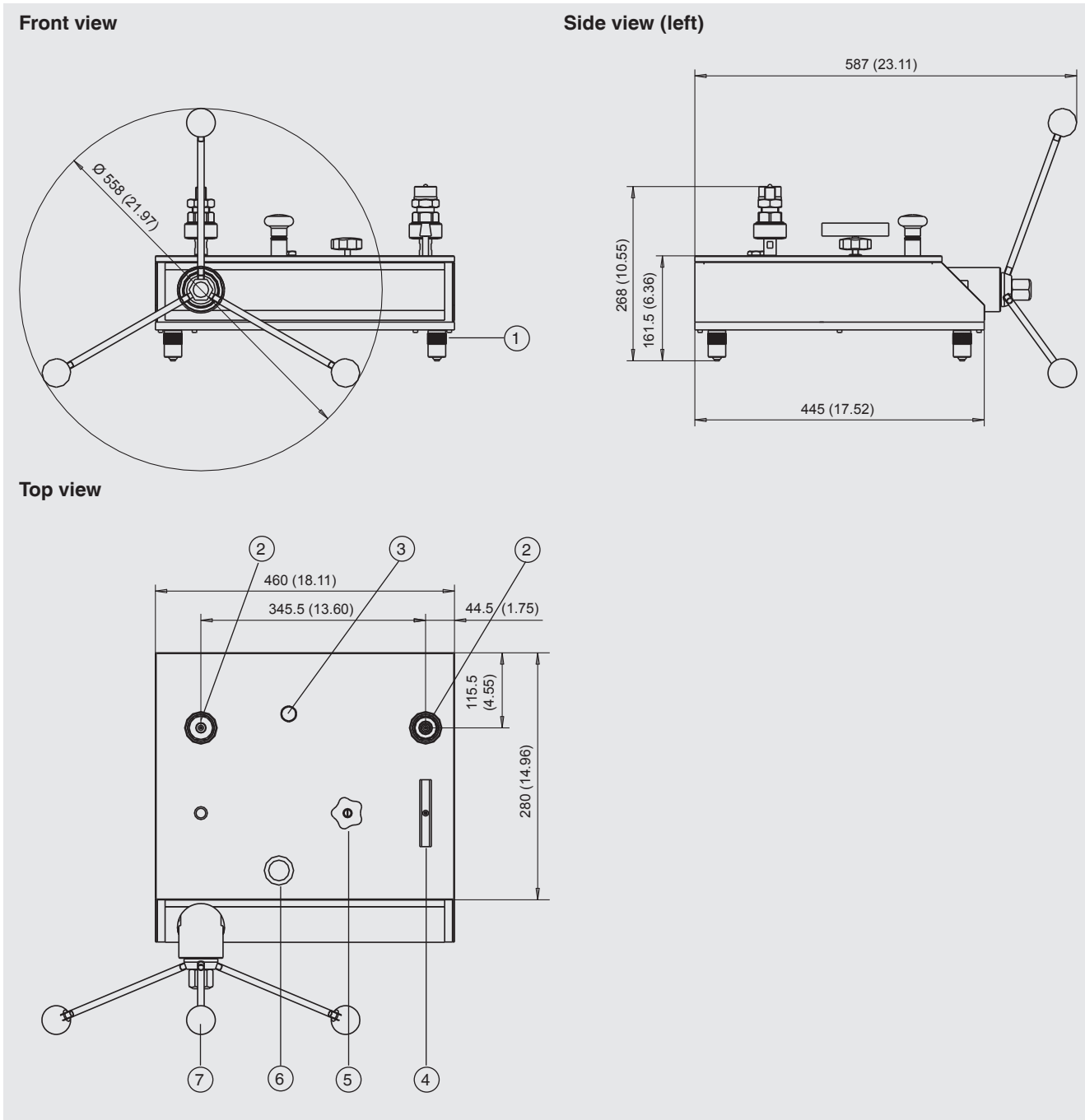

- ① Rotatable feet
- ② Test connections knurled nut G $\frac{3}{4}$ female, freely rotating with sealing cone, incl. changeable adapter to M16 x 1.5 male with sealing cone
- ③ Plug screw for medium reservoir
- ④ High-pressure shut-off valve (HP)
- ⑤ Low-pressure shut-off valve (LP)
- ⑥ Priming pump
- ⑦ Spindle pump with star handle

Recommended reference pressure measuring instruments

Precision digital pressure gauge model CPG1500

Measuring ranges: to 10,000 bar (150,000 psi)
Accuracy: to 0.025 % of span

For further specifications see data sheet CT 10.51



Hand-held pressure indicator model CPH6300

Measuring ranges: to 1,000 bar (14,500 psi)
Accuracy: to 0.1 % of span

For further specifications see data sheet CT 12.01



Precision hand-held pressure indicator model CPH6400

Measuring ranges: to 7,000 bar (101,500 psi)
Accuracy: to 0.025 % of span

For further specifications see data sheet CT 14.01



Process calibrator model CPH6000

Measuring ranges: to 6,000 bar (87,000 psi)
Accuracy: to 0.025 % of span

For further specifications see data sheet CT 15.01



Calibration software

WIKA-Cal calibration software for creating calibration certificates or logger protocols

For specifications see data sheet CT 95.10



Similar products

Hydraulic comparison test pump models CPP1000-X and CPP1600-X

Pressure range: to 1,600 bar (23,200 psi)
Transmission medium: Oil or water

For further specifications see data sheet CT 91.12





Hydraulic comparison test pump model CPP4000-X

Pressure range: to 4,000 bar (58,000 psi)
Transmission medium: Oil

For further specifications see data sheet CT 91.09

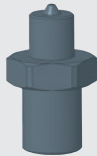

Accessories

Description		Order code
		CPP-A-D
	Sebacate oil in plastic bottle, content 0.5 litre	-D1-
	Adapters for connection column, M16 x 1.5 male with sealing cone, mat.: Hardened stainless steel	-D2-
	for connection column, M20 x 1.5 male with sealing cone, mat.: Hardened stainless steel	-D3-
	for connection column, 9/16-18 UNF male with sealing cone, mat.: Hardened stainless steel	-D4-
	for connection column, G 1/2 female with O-ring, max. 1,600 bar (23,200 psi), mat.: 1.4571	-D5-
	Mounting kit 2 x open-ended spanner M36	-D6-
	Sealing set	-D7-
Ordering information for your enquiry:		
1. Order code: CPP-A-D		↓
2. Option:		[]

Scope of delivery

- Comparison test pump with priming pump for filling, spindle pump for pressure generation and fine pressure adjustment
- Two adapters for connection column, M16 x 1.5 male with sealing cone, mat.: hardened stainless steel
- Sebacate oil in plastic bottle, content 0.5 litre
- Operating instructions

Ordering information

CPP7000-X / Additional adapters / Additional ordering information

© 08/2018 WIKA Alexander Wiegand SE & Co. KG, all rights reserved.
The specifications given in this document represent the state of engineering at the time of publishing.
We reserve the right to make modifications to the specifications and materials.

WIKA data sheet CT 91.13 · 08/2018

Page 6 of 6

Your WIKA Sales Partner



ICS Schneider Messtechnik GmbH

Briesestrasse 59

D-16562 Hohen Neuendorf / OT Bergfelde

Tel.: +49 3303 5040-66

Fax: +49 3303 5040-68

E-Mail: info@ics-schneider.de



WIKA Alexander Wiegand SE & Co. KG

Alexander-Wiegand-Straße 30

63911 Klingenberg/Germany

Tel. +49 9372 132-0

Fax +49 9372 132-406

info@wika.de

www.wika.de