

## Pressure sensor For medical gases Model MG-1

WIKA data sheet PE 81.44

### Applications

- Distribution and storage of medical gases
- Oxygen treatment for patients in hospitals, at home and in ambulances

### Special features

- Measuring ranges from 0 ... 6 to 0 ... 16 bar and from 0 ... 200 to 0 ... 400 bar
- Output signals 4 ... 20 mA, DC 0 ... 10 V, DC 0 ... 5 V, DC 1 ... 5 V, DC 0.5 ... 4.5 V ratiometric
- Oxygen clean in accordance with international standards
- Available in four levels of cleanliness
- Three packaging variants



Pressure sensor model MG-1

### Description

The model MG-1 pressure sensor has been developed for the pressure measurement of medical gases and for oxygen applications. Only materials that are suitable for oxygen applications are used.

In order to ensure the required level of cleanliness, any contamination of the components during production is avoided. The model MG-1 is manufactured under controlled conditions, then it is marked for use in oxygen applications and packed with special care.

In line with international directives, different levels of cleanliness, different packaging and different instrument markings are available.

The MG-1 pressure sensor offers a solution which is optimised for your application.

## Measuring ranges

Gauge pressure							
bar	Measuring range	0 ... 6	0 ... 10	0 ... 16	0 ... 200	0 ... 300	0 ... 400
	Overload safety	20	20	32	500	800	800
	Burst pressure	25	25	160	1,200	1,700	1,700
psi	Measuring range	0 ... 100	0 ... 150	0 ... 200	0 ... 3,000	0 ... 4,000	0 ... 5,000
	Overload safety	290	290	460	7,200	11,000	11,000
	Burst pressure	1,450	1,450	2,300	17,000	24,000	24,000

The given measuring ranges are also available in kg/cm<sup>2</sup>, MPa and kPa.

Vacuum and +/- measuring ranges are also available.

### Vacuum tightness

Yes

## Output signals

Signal type	Signal
Current (2-wire)	4 ... 20 mA
Voltage (3-wire)	DC 0 ... 10 V DC 0 ... 5 V DC 1 ... 5 V
Ratiometric (3-wire)	DC 0.5 ... 4.5 V

Depending on the signal the following loads apply:

Signal	Load in $\Omega$
4 ... 20 mA	$\leq (\text{power supply} - 8 \text{ V}) / 0.02 \text{ A}$
DC 0 ... 10 V DC 0 ... 5 V DC 1 ... 5 V DC 0.5 ... 4.5 V ratiometric	$> \text{max. signal} / 1 \text{ mA}$

## Voltage supply

The permissible power supply depends on the corresponding output signal.

Output signal	Power supply
4 ... 20 mA	DC 8 ... 30 V
DC 0 ... 10 V	DC 14 ... 30 V
DC 0 ... 5 V	DC 8 ... 30 V
DC 1 ... 5 V	DC 8 ... 30 V
DC 0.5 ... 4.5 V ratiometric	DC $5 \pm 0.5 \text{ V}$

### Total current consumption

maximum 10 mA (except for 2-wire signals)

## Accuracy

### Accuracy at reference conditions

$\leq \pm 2 \%$  of span

Including non-linearity, hysteresis, zero offset and end value deviation (corresponds to measured error per IEC 61298-2). Calibrated in vertical mounting position with process connection facing downwards.

### Non-linearity

$\leq \pm 0.5 \%$  of span BFSL (per IEC 61298-2)

### Temperature error

$\leq \pm 2.0 \%$  of span

### Long-term drift (per IEC 61298-2)

$\leq 0.3 \%$  of span/year

### Settling time

$\leq 2 \text{ ms}$

## Operating conditions

### Ingress protection (per IEC 60529)

IP67

The stated ingress protection only applies when plugged in using a mating connector that has the appropriate ingress protection.

### Vibration resistance

20 g (20 ... 2,000 Hz, 2 h) per IEC 60068-2-6

### Shock resistance

40 g (6 ms) per IEC 60068-2-27 (mechanical shock)

### Temperatures

Permissible temperature ranges		
Rated temperature range	-20 ... +70 °C	-4 ... +158 °F
Ambient	-20 ... +70 °C	-4 ... +158 °F
Medium	-20 ... +70 °C	-4 ... +158 °F
Storage	-25 ... +80 °C	-13 ... +176 °F

## Reference conditions (per IEC 61298-1)

### Temperature

15 ... 25 °C

### Atmospheric pressure

860 ... 1,060 mbar (665 ... 800 mmHg)

### Air humidity

45 ... 75 % relative, non-condensing

### Power supply

- DC 24 V
- DC 5 V with ratiometric output

### Mounting position

as required

## Process connections

Standard	Thread size
EN 837	G 1/8 B G 1/4 B
DIN 3852-E	G 1/4 A <sup>1)</sup>
ANSI/ASME B1.20.1	1/8 NPT 1/4 NPT
ISO 7	R 1/4
KS	1/4 PT
SAE	7/16-20 UNF-2A, O-ring BOSS <sup>1)</sup>

1) Sealing ring from FKM

## Electrical connections

### Short-circuit resistance

S<sub>+</sub> vs. 0V

### Reverse polarity protection

U<sub>B</sub> vs. 0V

### Insulation voltage

DC 500 V

### Connection diagrams

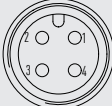
Circular connector M12 x 1			
		2-wire	3-wire
	U <sub>B</sub>	1	1
	0V	3	3
	S <sub>+</sub>	-	4

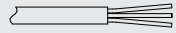
Cable outlet, unshielded			
		2-wire	3-wire
	U <sub>B</sub>	brown	brown
	0V	green	green
	S <sub>+</sub>	-	white

Wire cross-section 3 x 0.14 mm<sup>2</sup>

Cable diameter 3.2 mm

Cable length 2 m

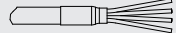
Cable outlet, shielded			
		2-wire	3-wire
	U <sub>B</sub>	brown	brown
	0V	blue	blue
	S <sub>+</sub>	-	black

Wire cross-section 3 x 0.14 mm<sup>2</sup>

Cable diameter 4.3 mm

Cable length 2 m

## Cleanliness specifications

Level of cleanliness	Measuring range < 30 bar/435 psi	Measuring range > 30 bar/435 psi
<b>Breathing gas</b>	Oil and grease free	Oil and grease free
■ Residual hydrocarbons	< 1,000 mg/m <sup>2</sup>	< 1,000 mg/m <sup>2</sup>
<b>Medical standard</b>	per ISO 15001	per ISO 15001
■ Residual hydrocarbons	< 550 mg/m <sup>2</sup>	< 220 mg/m <sup>2</sup>
■ Particle size	not applicable	on request
<b>Industrial standard</b>	Oil and grease free for oxygen per ASTM G93 level D/E	Oil and grease free for oxygen per ASTM G93 level D/E
■ Residual hydrocarbons	< 550 mg/m <sup>2</sup>	< 220 mg/m <sup>2</sup>
<b>High industrial standard</b>	Oil and grease free for oxygen per ASTM G93 level C	Oil and grease free for oxygen per ASTM G93 level C
■ Residual hydrocarbons	< 66 mg/m <sup>2</sup>	< 66 mg/m <sup>2</sup>

## Packaging

For the individual levels of cleanliness of the model MG-1 the following types of packaging are available.

Level of cleanliness	Type of packaging
<b>Breathing gas</b>	Protection cap on the process connection
<b>Medical standard</b>	<ul style="list-style-type: none"> <li>■ Standard: Protection cap on the process connection, instrument sealed in a plastic bag</li> <li>■ Option: Protection cap on the process connection, instrument sealed in two plastic bags</li> </ul>
<b>Industrial standard</b>	
<b>High industrial standard</b>	

## Materials

### Wetted parts

- Process connection from stainless steel 316L and 13-8 PH
- Sealing ring from FKM (if available)

### Non-wetted parts

- Case from stainless steel 316L
- Electrical connection from highly resistant, glass-fibre reinforced plastic PBT GF 30

## Dimensions in mm

### Pressure sensor



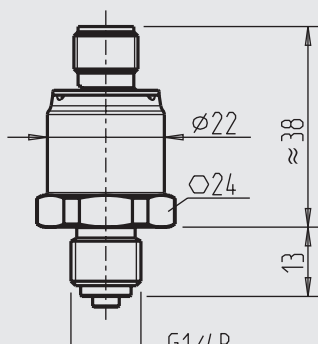

with M12 x 1 circular connector

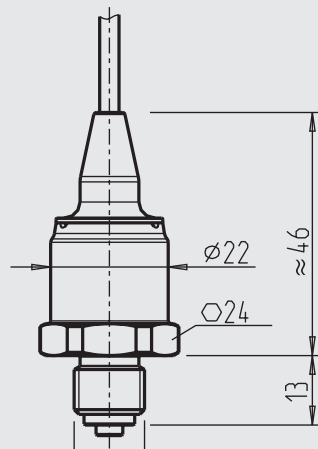

with cable outlet



## Approvals

Logo	Description	Country
	<b>EU declaration of conformity</b> <ul style="list-style-type: none"> <li>■ EMC directive, EN 61326 emission (group 1, class B) and immunity (industrial application)</li> <li>■ Pressure equipment directive</li> <li>■ RoHS directive</li> </ul>	European Union
	<b>EAC</b> EMC directive	Eurasian Economic Community
	<b>KazInMetr</b> Metrology, measurement technology	Kazakhstan
-	<b>MTSCHS</b> Permission for commissioning	Kazakhstan
	<b>Uzstandard</b> Metrology, measurement technology	Uzbekistan
-	<b>CRN</b> Safety (e.g. electr. safety, overpressure, ...)	Canada

## Process connections

DIN EN ISO 1179-2  
DIN EN ISO 9974-2  
(formerly DIN 3852-E)

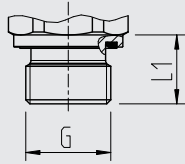

G	L1
G ¼ A	14

EN 837

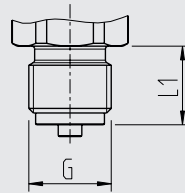

G	L1
G ¼ B	13

EN 837

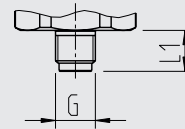

G	L1
G ½ B	10

ANSI/ASME B1.20.1  
KS  
ISO 7

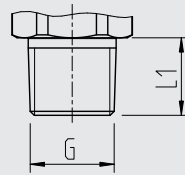

G	L1
½ NPT	10
¼ NPT	13
R ¼	13
PT ¼	13

SAE J514 E

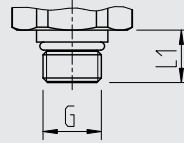

G	L1
7/16-20 UNF-2A	12.06

For information on tapped holes and welding sockets, see Technical information IN 00.14 at [www.wika.com](http://www.wika.com).

## Ordering information

Model / Measuring range / Output signal / Electrical connection / Process connection / Level of cleanliness / Type of packaging

© 2011 WIKA Alexander Wiegand SE & Co. KG, all rights reserved.  
The specifications given in this document represent the state of engineering at the time of publishing.  
We reserve the right to make modifications to the specifications and materials.

WIKA data sheet PE 81.44 · 07/2023

Page 6 of 6

Your WIKA Sales Partner



**ICS Schneider Messtechnik GmbH**  
Briesestrasse 59  
D-16562 Hohen Neuendorf / OT Bergfelde  
Tel.: +49 3303 5040-66  
Fax: +49 3303 5040-68  
E-Mail: [info@ics-schneider.de](mailto:info@ics-schneider.de)



**WIKAL Alexander Wiegand SE & Co. KG**  
Alexander-Wiegand-Straße 30  
63911 Klingenberg/Germany  
Tel. +49 9372 132-0  
Fax +49 9372 132-406  
[info@wika.de](mailto:info@wika.de)  
[www.wika.de](http://www.wika.de)