

Dual differential pressure sensor For ventilation and air-conditioning Model A2G-52

WIKA data sheet PE 88.03



for further approvals
see page 5



Applications

- For monitoring air, non-flammable and non-aggressive gases
- Fan, blower and filter monitoring
- Pressure and flow monitoring
- Monitoring and control of valves and air shutters
- Pressure monitoring in clean rooms

Special features

- Simple mounting
- Two differential pressure sensors in one instrument
- Two inputs for temperature sensors or analogue signal
- With Modbus® interface
- Two-line LC display for the direct reading of both pressure values



Dual differential pressure sensor, model A2G-52

Description

The model A2G-52 dual differential pressure sensor combines two differential pressure sensors in one instrument, so that pressure can be measured from two different control points.

The model A2G-52 has a Modbus® interface and an input interface. By using the input interface, up to two passive temperature sensors or an analogue 0 ... 10 V signal can be connected directly to the measuring instrument. Thus, the use of cost-intensive active temperature transmitters can be dispensed with and the costs for material and mounting can be reduced.

Specifications

Dual differential pressure sensor, model A2G-52	
Measuring element	Piezo measuring cell
Units of measure	Pa, mbar, inWC, mmWC, psi
Measuring range	-250 ... +2,500 Pa and -250 ... +7,500 Pa
Accuracy class	-250 ... +2,500 Pa = pressure < 125 Pa = ± 2 Pa + 1 % pressure > 125 Pa = ± 1 Pa + 1 % -250 ... +7,000 Pa = pressure < 125 Pa = ± 2 Pa + 1.5 % pressure > 125 Pa = ± 1 Pa + 1.5 % all data refer to the current measured value (of measured pressure)
Process connection	Connecting nozzle (copper alloy), lower mount, for hoses with inner diameter 4 mm
Power supply U_B	AC 24 V or DC 24 V ± 10 %
Electrical connection	Cable gland M20 2 x 4 spring-clip terminals, max. 1.5 mm ²
Output signal	Modbus®
Display	Two-line LC display (12 characters/line) Line 1: Active measurement, input A Line 2: Active measurement, input B
Case	Plastic (ABS) Cover: Polycarbonate (PC)
Permissible temperatures	■ Ambient temperature ■ Medium temperature
	-20 ... +70 °C -10 ... +50 °C
Relative humidity	0 ... 95 % r. h., non-condensing
Ingress protection	IP54
Weight	150 g

Modbus® communication	
Protocol	Modbus® via serial interface
Transfer mode	RTU
Interface	RS-485
Byte format	(11 bits) in RTU mode Coding system: 8 bits binary Bits per byte: - 1 Start bit - 8 data bits, lowest-order bit is sent first - 1 bit for parity - 1 stop bit
Baud rate	9,600, 19,200, 38,400 - adjustable in the configuration
Modbus® addresses	1 ... 247 addresses - adjustable in the configuration

Options

- 4 duct connectors
- 4 m PVC hose, inner diameter 4 mm

Modbus® register

FC04 - Read input register

Register	Parameter description	Data type	Value	Display
3x0001	Program version	16 bit	0 ... 1,000	0.00 ... 99.00
3x0002	Pressure measurement A	16 bit	-250 ... 2,500	-250 ... 2,500 (Pa)
3x0003	Pressure measurement B	16 bit	-250 ... 2,500	-250 ... 2,500 (Pa)
3x0004	Input 1: 0 ... 10 V	16 bit	0 ... 1,000	0 ... 100 %
3x0005	Input 1: Pt1000	16 bit	500 ... 500	-50 ... +50 °C
3x0006	Input 1: Ni1000	16 bit	-500 ... 500	-50 ... +50 °C
3x0007	Input 1: Ni1000-LG	16 bit	-500 ... 500	-50 ... +50 °C
3x0008	Input 1: NTC10k	16 bit	-500 ... 500	-50 ... +50 °C
3x0009	Input 2: 0 ... 10 V	16 bit	0 ... 1,000	0 ... 100 %
3x0010	Input 2: Pt1000	16 bit	-500 ... 500	-50 ... +50 °C
3x0011	Input 2: Ni1000	16 bit	-500 ... 500	-50 ... +50 °C
3x0012	Input 2: Ni1000-L	16 bit	-500 ... 500	-50 ... +50 °C
3x0013	Input 2: NTC10k	16 bit	-500 ... 500	-50 ... +50 °C

FC02 - Read input status

Register	Parameter description	Data type	Value	Display
1x0001	Input 1: BIN IN	Bit 0	0 ... 1	On - Off
1x0002	Input 2: BIN IN	Bit 0	0 ... 1	On - Off

FC05 - Write single coil

Register	Parameter description	Data type	Value	Display
0x0001	Zeroing	Bit 0	0 ... 1	On - Off

FC06 - Write single register

Register	Parameter description	Data type	Value	Display
4x0001	Beta value of NTC resistor	16 bit	0 ... 30,000	0 ... 30,000 (standard 4,220)

Electrical connection

Connection diagram

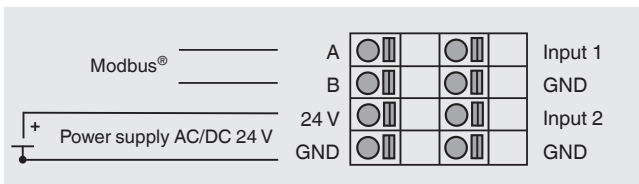

Connection diagram for input signals

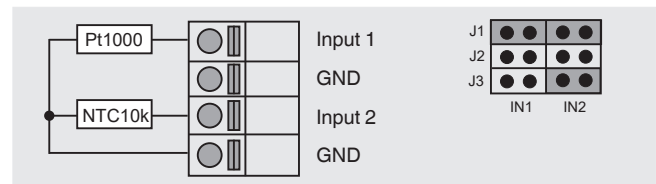

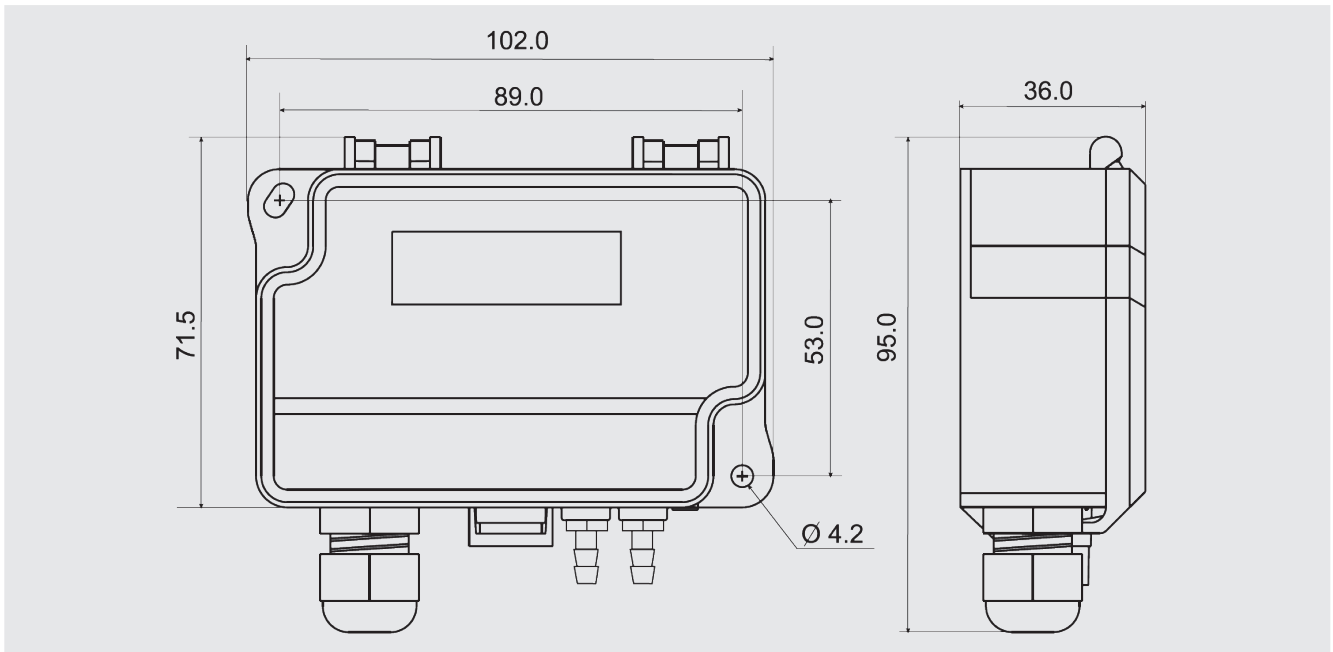

Input 1: Pt1000 temperature sensor
 Function 04: Read input value for register 3x0005
 Input 2: NTC10k temperature sensor
 Function 04: Read input value for register 3x0008

Dimensions in mm





Description	Order number
A2G-52 with measuring range -250 ... +2,500 Pa	40399907
A2G-52 with measuring range -250 ... +7,000 Pa	40399920

Accessories

Description	Order number
Measuring hoses	
 PVC hose, inner diameter 4 mm, roll at 25 m	40217841
PVC hose, inner diameter 6 mm, roll at 25 m	40217850
Silicone hose, inner diameter 4 mm, roll at 25 m	40208940
Silicone hose, inner diameter 6 mm, roll at 25 m	40208958
Duct connector for hose 4 and 6 mm	40217507
	

Approvals

Logo	Description	Country
	EU declaration of conformity <ul style="list-style-type: none">■ EMC directive■ RoHS conformity■ WEEE directive	European Union
	EAC (option) <ul style="list-style-type: none">■ EMC directive■ Import certificate	Eurasian Economic Community
	GOST (option) Metrology, measurement technology	Russia
-	MTSCHS (option) Permission for commissioning	Kazakhstan

Certificates (option)

2.2 test report

Approvals and certificates, see website

Scope of delivery

- Dual differential pressure sensor
- 2 mounting screws

Ordering information

To order the described product the order number is sufficient.

or

Model / Measuring range / Input signal / Accessories / Options

© 04/2015 WIKA Alexander Wiegand SE & Co. KG, all rights reserved.
The specifications given in this document represent the state of engineering at the time of publishing.
We reserve the right to make modifications to the specifications and materials.