

Miniature pressure switch, stainless steel

For the process industry

Model PXS

WIKA data sheet PV 34.36



for further approvals,
see page 5

Process Mini Series

Applications

- Pressure monitoring and control of processes
- Safety-critical applications in general process instrumentation, especially in the chemical and petrochemical industries, oil and gas industries, power generation incl. nuclear power plants, water/wastewater industries, mining
- For gaseous and liquid, aggressive and highly viscous or contaminated media, also in aggressive environments
- For measuring locations with limited space, e.g. control panels

Special features

- Compact and slimline design
- Robust switch enclosure from stainless steel 316, IP66, NEMA 4X
- Intrinsic safety Ex ia available
- Wide selection of setting ranges available, 1 ... 2.5 bar to 200 ... 1,000 bar
- High switching power and large selection of contact variants and electrical connections



Miniature pressure switch model PXS

Description

These high-quality mechanical pressure switches have been developed especially for safety-critical applications. The great advantage of mechanical pressure switches is that no supply voltage is required for the switching process.

In production, the switches are traced by quality assurance software at every step and subsequently are 100 % tested. Due to its compactness, the model PXS pressure switch can be installed in measurement environments with limited space. The robust switch enclosure from stainless steel 316 can withstand the rough and corrosive operating conditions of the process industry with working ranges of up to 1,000 bar.

The pressure switch is fitted with microswitches, which make it possible to switch an electrical load of up to AC 250 V, 5 A directly within a repeatability of 1 % of the set point.

Depending on the application, the appropriate variant for the contact version and the electrical connection can be selected; e.g., hermetically sealed microswitches are suitable for corrosive ambient conditions and DPDT contact versions for two separate circuits.

A Belleville spring provides for the simultaneous triggering of the DPDT contact and, through the snap-acting behaviour, increases the stability and vibration resistance.

For safety applications, the pressure switch is optionally available in a SIL 2 qualified or a SIL 3 qualified version.

Specifications

Basic information	
Version	Miniature pressure switch
Special design feature	<ul style="list-style-type: none"> ■ Version for hazardous areas (Ex ia) ■ For oxygen, oil- and grease-free ■ Per NACE ¹⁾ MR0175 / ISO 15156, use in H₂S-containing environments in oil and gas production ■ Per NACE ¹⁾ MR0103 / ISO 17945, metals resistant to sulphide stress cracking ■ Drying of wetted parts ■ Offshore version ■ Tropical version (suitable for environments with increased air humidity) ■ Version for ammonia applications ■ Geothermal version ■ Assembled as a diaphragm seal system
Contact version	<ul style="list-style-type: none"> ■ 1 x SPDT (single pole double throw) ■ 1 x DPDT (double pole double throw) Microswitch, hermetically sealed, with fixed dead band The DPDT function is realised with 2 simultaneously triggering SPDT microswitches. → See table "Contact version"
Dielectric strength	Safety class I (IEC 61298-2: 2008)
Switch enclosure	
Design	Tamper-proof due to access cover plate with lead seal option Laser-engraved product label from stainless steel
Material	Stainless steel 316
Mounting	<ul style="list-style-type: none"> ■ Direct mounting ■ Wall bracket from stainless steel ■ Mounting bracket for 2" pipe mounting

1) General information about NACE standards, see data sheet IN 00.21

Contact version		Electrical rating (resistive load)	
		AC	DC
E	1 x SPDT, silver, hermetically sealed	250 V, 5 A	24 V, 5 A
J	1 x SPDT, gold-plated, hermetically sealed	250 V, 0.5 A	24 V, 1 A
L	1 x DPDT, silver, hermetically sealed	250 V, 5 A	24 V, 5 A
M	1 x DPDT, gold-plated, hermetically sealed	250 V, 0.5 A	24 V, 1 A

Sensor element		Wetted parts		Permissible medium temperature ¹⁾
		Sensor element	Sealing	
M	1 = Welded diaphragm element with antagonist spring	Hastelloy C276	-	-40 ... +200 °C
	2 = Diaphragm element with antagonist spring and O-ring	Hastelloy C276	O-ring: FPM	-30 ... +200 °C
G	Piston with antagonist spring and welded diaphragm element	Hastelloy C276	-	-40 ... +140 °C
P	Piston with antagonist spring ²⁾ ³⁾	Stainless steel 316L	O-ring: FPM	0 ... 200 °C
			O-ring: NBR	-10 ... +110 °C
			O-ring: EPDM	-40 ... +110 °C

1) Permissible medium temperature range in the main process line. Depending on the measuring assembly, this may differ from the permissible temperature at the process connection. For further information, see operating instructions.

2) Particularly suited for liquid media.

3) Ignition protection type: Ex d IIC T6/T5 Gb and Ex tb IIIC T85/T135 Db IP66. → See Ex marking page 5

Accuracy specifications	
Set point repeatability	≤ 1 % of end of setting range
Dead band	→ See table "Setting range of set point"

Setting range of set point in bar	Sensor element	Setting range depending on the switching direction in bar		Working range in bar	Proof pressure in bar	Max. dead band	
		rising	falling			Start of setting range ⁴⁾ in bar	End of setting range ⁴⁾ in bar
-1 ... 1.5	M ⁵⁾	-0.7 ... 1.5	-0.9 ... 1.2	-1 ... 10	40	0.3	0.3
1 ... 2.5 ⁶⁾	M ⁵⁾	1.3 ... 2.5	1 ... 2.2	0 ... 10	16	0.3	0.3
1.6 ... 6	M ⁵⁾	2.1 ... 6	1.6 ... 5.8	0 ... 10	16	0.5	0.2
2 ... 6	M ⁷⁾	2.5 ... 6	2 ... 5.8	0 ... 207	315	0.5	0.2
3 ... 10	M ⁷⁾	4.5 ... 10	3 ... 9.2	0 ... 207	315	1.5	0.8
3 ... 10	M ⁵⁾	4.5 ... 10	3 ... 9.2	0 ... 10	16	1.5	0.8
6 ... 25 ⁶⁾	M ⁵⁾	8 ... 25	6 ... 24.2	0 ... 25	40	2	0.8
6 ... 25	M ⁷⁾	8 ... 25	6 ... 24.2	0 ... 207	315	2	0.8
14 ... 60	P, G	23 ... 60	14 ... 49	0 ... 500	750	9	11
25 ... 100	P, G	40 ... 100	25 ... 82	0 ... 500	750	15	18
50 ... 160	P, G	65 ... 160	50 ... 142	0 ... 500	750	15	18
70 ... 400	P, G	95 ... 400	70 ... 365	0 ... 500	750	25	35
150 ... 700 ⁸⁾	P	230 ... 700	150 ... 600	0 ... 1,000	1,500	80	100
200 ... 1,000 ⁸⁾	P	300 ... 1,000	200 ... 850	0 ... 1,000	1,500	100	150

4) The dead band depends on the set point adjustment. The indicated values are valid for start and end of the setting range. The dead band of other set points is proportional.

5) Sensor element "M" with welded diaphragm element (1)

6) With DPDT contact, simultaneous actuation occurs within 1 % of the end of the setting range

7) Sensor element "M" with O-ring: FPM (2)

8) Setting range is recommended for hydraulic systems

Other setting ranges on request

Set point adjustment

The set point can be specified by the customer or factory-set within the setting range.

The switch point and the switching direction need to be specified (e.g. switch point: 2 bar, rising).

The set point is selectable within the entire setting range. For optimal performance we suggest to adjust the set point between 25 ... 75 % of the setting range. In the following example, the maximum possible setting range is shown to be dependent upon the switching direction.

Example

Setting range: 1 ... 2.5 bar with one switch contact

Dead band = 0.3 bar (→ See table "Setting ranges")

Rising pressure: Set point can be adjusted between 1.3 ... 2.5 bar

Falling pressure: Set point can be adjusted between 1 ... 2.2 bar

Subsequent adjustment of the set point on-site is made using the adjustment screw, which is covered by the access cover plate with lead seal option.

→ See operating instructions for further details.

Process connection	
Standard	<ul style="list-style-type: none"> ■ ANSI/ASME B1.20.1 ■ DIN EN ISO 228
Size	
ANSI/ASME B1.20.1	<ul style="list-style-type: none"> ■ ¼ NPT, female thread ■ ½ NPT, female thread via adapter ■ ½ NPT, male thread via adapter
DIN EN ISO 228	<ul style="list-style-type: none"> ■ G ¼, female thread via adapter ■ G ½ A, male thread via adapter ■ G ¼ A, male thread via adapter
Material (wetted)	
Process connection	Stainless steel 316L Other materials on request
Sensor element	Depending on the selected sensor element → See table "Sensor element"

Other process connections on request

Electrical connection	
Connection type	<ul style="list-style-type: none"> ■ Threaded connection with connection cable, ½ NPT male thread ■ Threaded connection with connection cable, M20 x 1.5 via adapter ■ Threaded connection with connection cable, ½ NPT female thread via adapter ■ Threaded connection with connection cable, ¾ NPT female thread via adapter ■ Terminal box, 3 x female thread ½ NPT, IP65
Wire cross-section	0.5 mm ² (20 AWG)
Cable length	
Threaded connection with connection cable	<ul style="list-style-type: none"> ■ 1.5 m ■ 3 m ■ 5 m Other lengths on request
Terminal box	-
Pin assignment	Connection details are given on the product label of the instrument. Connection terminals and the ground terminal are appropriately marked.
Material	
Threaded connection with connection cable	Threaded connection: Stainless steel 316 Cable sheath: Silicone
Terminal box	Aluminium alloy, copper-free, epoxy resin coated









Operating conditions		
Medium temperature range	Ex version ¹⁾	T _M -30 ... +60 °C
	Other versions	→ See table "Sensor element"
Ambient temperature range	T6/T85°C	T _a -30 ... +60 °C
	T4/T135°C	T _a -30 ... +85 °C
	Other versions	T _a -30 ... +85 °C
Ingress protection of the complete instrument	IP66 per EN/IEC 60529 (NEMA 4X)	
Weight	<ul style="list-style-type: none"> ■ 0.6 kg, with cable outlet and 1.5 m connection cable ■ 1.1 kg, with terminal box 	

1) Further restriction possible depending on sensor element and sealing. → See table "Sensor element".

Approvals

Logo	Description	Region
	EU declaration of conformity	European Union
	Pressure equipment directive	
	EMC directive	
	Low voltage directive	
	RoHS directive	

Optional approvals

Logo	Description	Region
 	EU declaration of conformity	European Union
	ATEX directive ¹⁾ I M 1 II 1 GD	
 	IECEX ¹⁾ Ex ia I Ma Ex ia IIC T6/T4 ²⁾ Ga Ex ia IIIC T85°C/T135°C ²⁾ Da IP66	International
 	EAC	Eurasian Economic Community
	EMC directive	
	Pressure equipment directive	
	Low voltage directive Hazardous areas ¹⁾	
	Ex Ukraine Hazardous areas ¹⁾	Ukraine
	CCC Hazardous areas ¹⁾	China
	KOSHA Hazardous areas ¹⁾	South Korea

1) Double marking ATEX and IECEX on the same product label. Country-specific Ex marking according to selected option.

2) The temperature class is related to the ambient temperature range

Manufacturer's information and certificates

Logo	Description
	SIL 3-capable (option) Functional safety per IEC 61508 Contains performance level calculation per ISO 13849-1

Certificates (option)

Certificates	
Certificates	<ul style="list-style-type: none"> ■ 2.2 test report per EN 10204 (e.g. state-of-the-art manufacturing, indication accuracy) ■ 3.1 inspection certificate per EN 10204 (e.g. indication accuracy)
Recommended recalibration interval	1 year (dependent on conditions of use)

For approvals and certificates, see website

Safety-related characteristic values (only for Ex version)

Safety-related characteristic values (Ex)	
Voltage	$U_i = DC\ 30\ V$
Current	$I_i = 100\ mA$
Power	$P_i = 750\ mW$
Effective internal capacitance	$C_i \leq 0\ \mu F$
Effective internal inductance	$L_i = 0\ mH$

Dimensions in mm

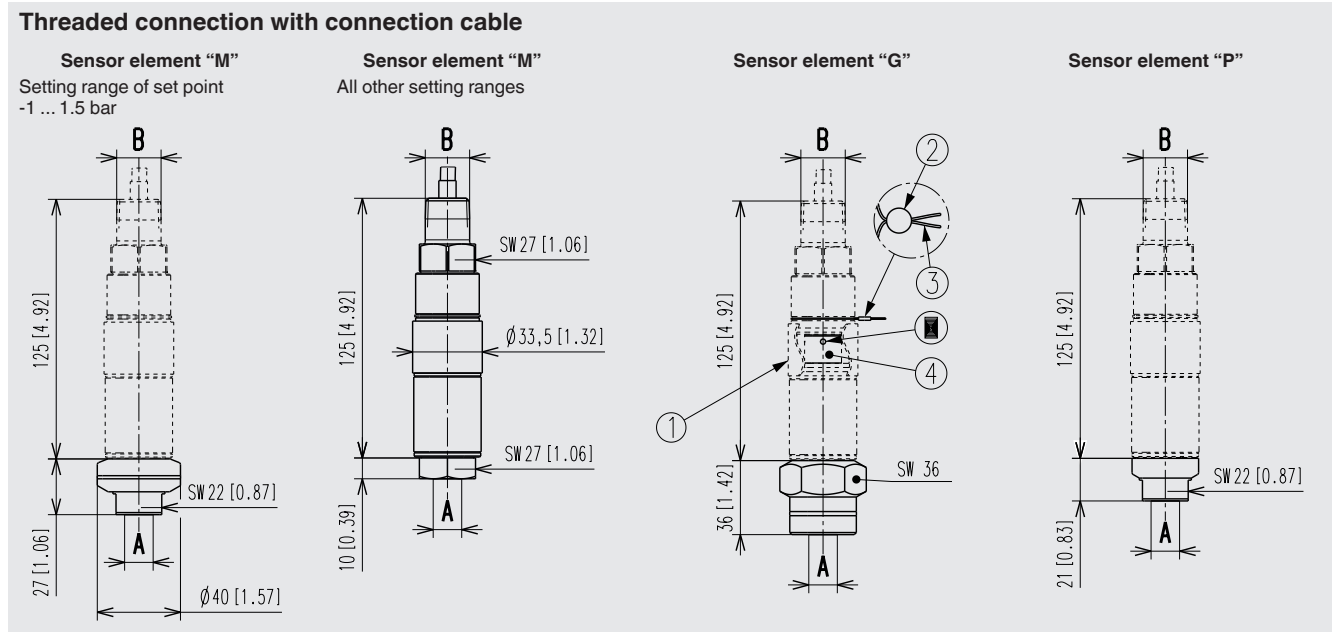





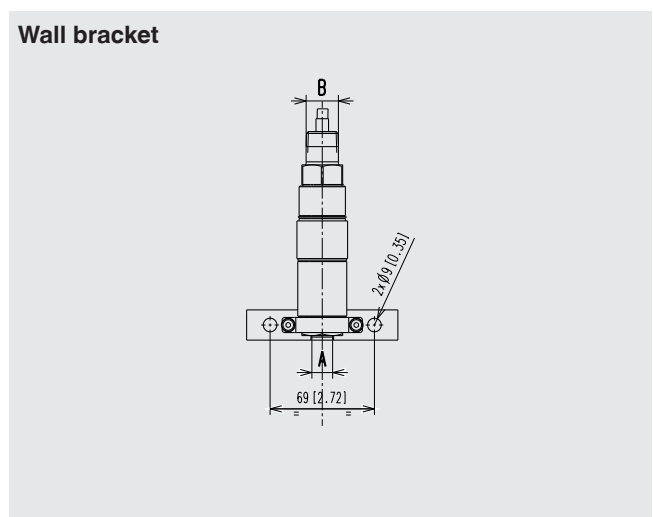
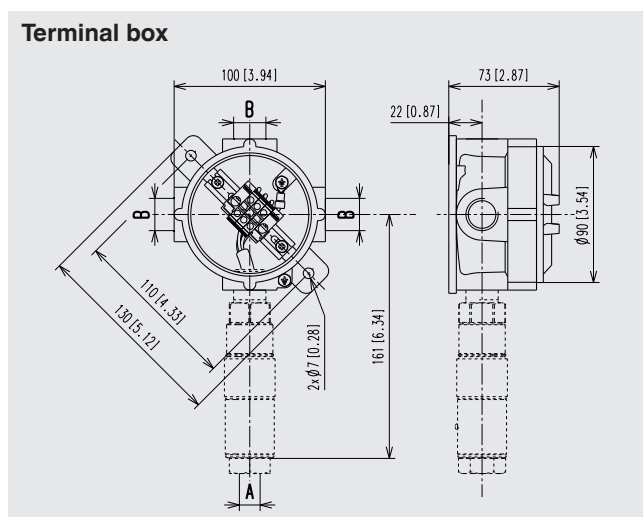

Legend

- ① Access cover plate
- ② Lead seal
- Bore $\varnothing\ 3\ mm$ (for adjustment)
- ③ Stainless steel wire
- ④ Adjustment screw
- A Process connection
- B Electrical connection



Accessories and spare parts

Model	Description
	910.15 Syphons → see data sheet AC 09.06
	910.13 Overpressure protector → see data sheet AC 09.04
	IV10, IV11 Needle valve and multiport valve → see data sheet AC 09.22
	IV20, IV21 Block-and-bleed valve → see data sheet AC 09.19
	IVM Monoflange, process and instrument version → see data sheet AC 09.17
	BV Ball valve, process and instrument version → see data sheet AC 09.28

Ordering information

Model / Sensor element / Contact version / Setting range / Process connection / Electrical connection / Options

© 12/2010 WIKA Alexander Wiegand SE & Co. KG, all rights reserved.
 The specifications given in this document represent the state of engineering at the time of publishing.
 We reserve the right to make modifications to the specifications and materials.

Your WIKA Sales Partner



ICS Schneider Messtechnik GmbH
 Briesestrasse 59
 D-16562 Hohen Neuendorf / OT Bergfelde
 Tel.: +49 3303 5040-66
 Fax: +49 3303 5040-68
 E-Mail: info@ics-schneider.de



WIKA Alexander Wiegand SE & Co. KG
 Alexander-Wiegand-Straße 30
 63911 Klingenberg/Germany
 Tel. +49 9372 132-0
 Fax +49 9372 132-406
 info@wika.de
 www.wika.de