

Differential pressure switch For very low setting ranges Model DW03UN

WIKA data sheet PV 35.50



Process Performance Series

Applications

- Differential pressure monitoring and control of processes
- Safety-critical applications in general process instrumentation, especially in HVAC and power generation incl. nuclear power plants
- For gaseous and dry media

Special features

- No power supply needed for switching of electrical loads
- Robust switch enclosure from stainless steel 316L, IP66, NEMA 4X
- Setting ranges from 0.3 ... 2.5 mbar to 0.7 ... 16 mbar with high working pressure and high static pressure up to 300 mbar
- Intrinsic safety Ex ia available
- 1 set point, SPDT, high switching power up to AC 250 V, 10 A

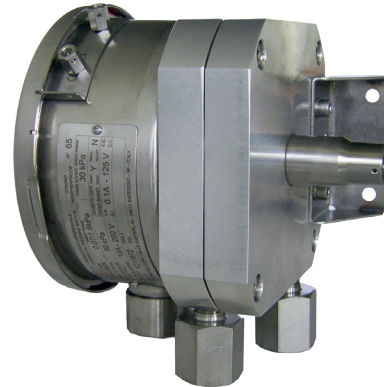

Differential pressure switch, model DW03UN

Description

These high-quality differential pressure switches have been developed especially for safety-critical applications. The high quality of the products and manufacturing in accordance with ISO 9001 ensure reliable monitoring of your plant. In production, the switches are traced by quality assurance software at every step and subsequently are 100 % tested.

In order to ensure as flexible operation as possible, the differential pressure switches are fitted with micro switches, which enable the switching of an electrical load of up to AC 250 V, 10 A directly.

By using a diaphragm measuring system, the model DW03UN differential pressure switch is extremely robust and guarantees optimal operating characteristics and the highest measuring performances, with repeatability lower than 1 % of span.

The process connection with a centre distance of 54 mm lower mount allows an easy and comfortable mounting of a standard valve manifold.

Standard version

Measuring system

Single diaphragm
For clean gas or non-condensing vapour only

Switch enclosure

Stainless steel 316L, tamper-proof. Laser-engraved product label from stainless steel.

Ingress protection

IP66 per EN/IEC 60529, NEMA 4X

Switch contact

Micro switches with fixed dead band
1 x SPDT (single pole double throw)

Permissible temperature

Ambient	T6/T85°C	T _a	-30 ... +60 °C
	T4/T135°C	T _a	-30 ... +85 °C
	Other versions	T _a	-30 ... +85 °C
Medium		T _M	-30 ... +85 °C

Ex marking (option)

- Ex ia I Ma
- Ex ia IIC T6/T4 ¹⁾ Ga
- Ex ia IIIC T85°C/T135°C ¹⁾ Da IP66

¹⁾ The temperature class is related to the ambient temperature range. See the type examination certificate for further details

Safety-related maximum values

(only for optional Ex ia versions)

Maximum values	
Voltage U _i	DC 30 V
Current I _i	100 mA
Power P _i	0.75 W
Internal capacitance C _i	0 µF
Internal inductance L _i	0 mH

Contact version	Electrical rating (resistive load)		Suitable for Ex ia option
	AC	DC	
UN 1 x SPDT, silver	250 V, 10 A	125 V, 0.1 A	Yes

Set point adjustment

The set point can be specified by the customer or factory-set within the setting range. Subsequent adjustment of the set point on site is made using the adjustment screw, which is fastened to the switch and thus secured against loss.

Repeatability of the set point

≤ 1 % of span

Please specify:

Set point, switching direction for the contact, e.g.:
Set point: 5 mbar, falling
For optimal performance we suggest to adjust the set point between 25 ... 75 % of the span.

Example

Setting range: 0.4 ... 10 mbar with one switch contact
Repeatability: 1 % of 9.6 mbar = 0.096 mbar
Dead band: (see table setting ranges)
2 x repeatability + dead band = 2 x 0.096 mbar + 0.3 mbar = 0.492 mbar.
Rising pressure: Adjust set point between 0.892 ... 10 mbar.
Falling pressure: Adjust set point between 0.4 ... 9.508 mbar.

Process connection

Lower mount (LM)

- ¼ NPT female (standard)
- ½ NPT, G ½ A, G ¼ A male via adapter
- ½ NPT, G ¼ female via adapter
- M20 x 1.5 male via adapter

Wetted parts

Diaphragm: Glass-fibre reinforced NBR
Process connection: Aluminium casting alloy, Anticorodal® UNI 3571
Other parts: Stainless steel, epoxy resin coated

Mounting

- Mounting fixture from stainless steel (AISI 304)
- Option: Mounting bracket for 2" pipe mounting (AISI 304)

Electrical connection

- ½ NPT female (standard)
- ¾ NPT, M20 x 1.5, G ½, G ¾ female
- Cable gland non-armoured, nickel-plated brass
- Cable gland non-armoured, stainless steel (AISI 304)
- Cable gland armoured, nickel-plated brass
- Cable gland armoured, stainless steel (AISI 304)
- MIL connector, 7-pin, DTL 5015

For cable connections to the internal terminal block use wire cross-sections between 0.5 ... 2.5 mm².

For the grounding cable connection to the protective conductor use max. 4 mm² for the internal and external screw.

Dielectric strength

Safety class I (IEC 61298-2: 2008)

Weight

- approx. 2.2 kg

Setting range

Setting range in mbar	Working range in mbar	One-sided pressure in mbar	Static pressure in mbar	Fixed dead band for contact version UN
0.3 ... 2.5	0 ... 2.5	≤ 6	≤ 300	≤ 0.2
0.4 ... 4	0 ... 4	≤ 10		≤ 0.3
0.4 ... 6	0 ... 6	≤ 25		≤ 0.3
0.4 ... 10	0 ... 10	≤ 25		≤ 0.3
0.7 ... 16	0 ... 16	≤ 40		≤ 0.5

For clean gas or non-condensing vapour only







Other Versions

Cleaned for oxygen service

Assembly

Valve manifold for differential pressure measuring instruments, models IV30, IV31 and IV50 und IV51 see data sheet AC 09.23

Approvals

Logo	Description	Country
	EU declaration of conformity <ul style="list-style-type: none"> ■ Pressure equipment directive ■ Low voltage directive ■ RoHS directive ■ ATEX directive ¹⁾ I M 1 II 1 GD 	European Community
	IECEx ¹⁾ Ex ia I Ma Ex ia IIC T6/T4 ²⁾ Ga Ex ia IIIC T85°C/T135°C ²⁾ Da IP66	International
	EAC (option) Hazardous areas ¹⁾	Eurasian Economic Community
	Ex-Ukraine (option) Hazardous areas ¹⁾	Ukraine
	CCC (option) Hazardous areas ¹⁾	China
	KOSHA (option) Hazardous areas ¹⁾	South Korea

1) Double marking ATEX and IECEx on the same product label. Country-specific Ex marking according to selected option.

2) The temperature class is related to the ambient temperature range

Manufacturer's information and certifications

Logo	Beschreibung
	SIL 3-capable (option) Functional safety per IEC 61508 Includes performance level calculation according to ISO 13849-1

Certificates (option)

- 2.2 test report per EN 10204
- 3.1 inspection certificate per EN 10204

Approvals and certificates, see website

Dimensions in mm

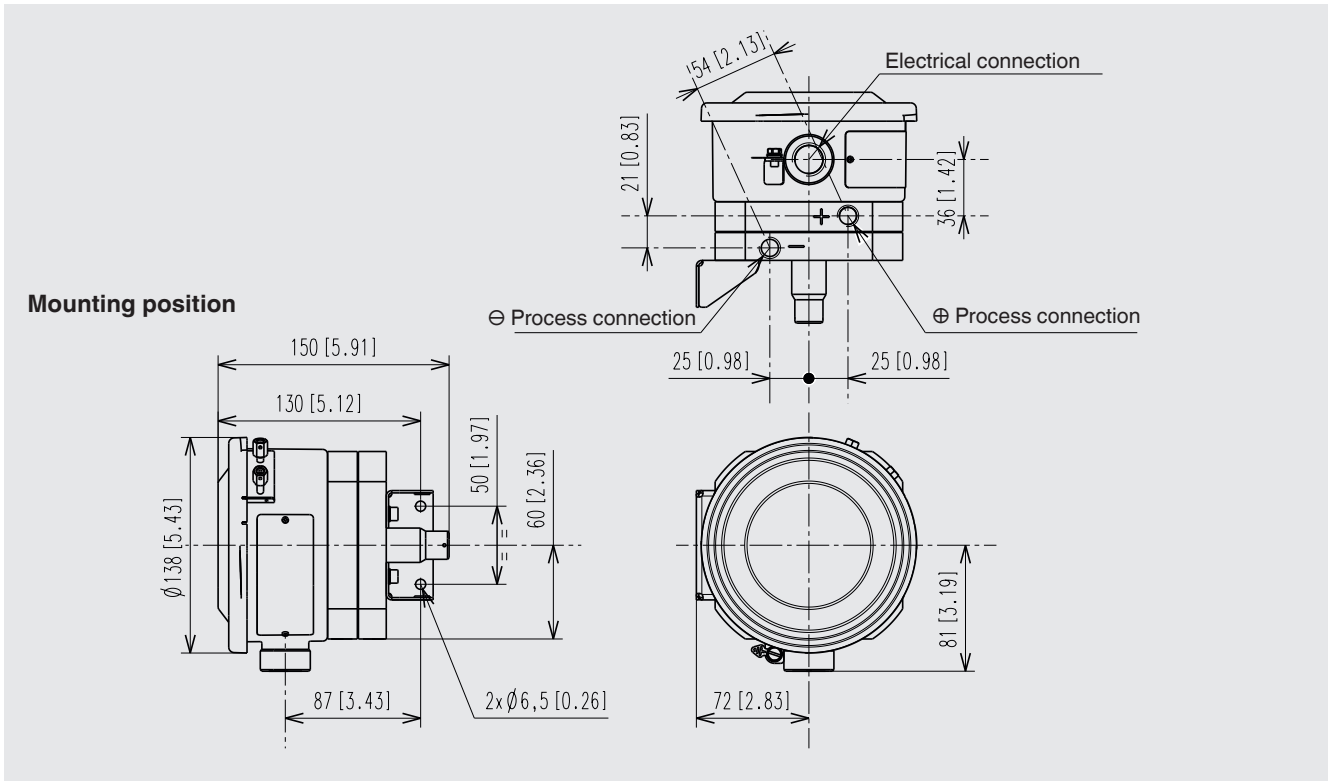

Ordering information

Model / Static - One-sided pressure / Setting range / Process connection / Electrical connection / Options

© 01/2011 WIKA Alexander Wiegand SE & Co. KG, all rights reserved.
The specifications given in this document represent the state of engineering at the time of publishing.
We reserve the right to make modifications to the specifications and materials.

WIKA data sheet PV 35.50 · 07/2021

Page 5 of 5

Your WIKA Sales Partner



ICS Schneider Messtechnik GmbH
Briesestrasse 59
D-16562 Hohen Neuendorf / OT Bergfelde
Tel.: +49 3303 5040-66
Fax: +49 3303 5040-68
E-Mail: info@ics-schneider.de



WIKAL Alexander Wiegand SE & Co. KG
Alexander-Wiegand-Straße 30
63911 Klingenberg/Germany
Tel. +49 9372 132-0
Fax +49 9372 132-406
info@wika.de
www.wika.de