

Digital temperature transmitter With HART® protocol, head and rail-mounted version Models T32.1S, T32.3S

WIKAI data sheet TE 32.04



for further approvals
see page 8



Applications

- Process industry
- Machine building and plant construction

Special features

- TÜV certified SIL version for protection systems developed per IEC 61508 (option)
- Operation in safety applications to SIL 2 (single instrument) and SIL 3 (redundant configuration)
- Configurable with almost all soft- and hardware tools
- Universal for the connection of 1 or 2 sensors
 - Resistance thermometer, resistance sensor
 - Thermocouple, mV sensor
 - Potentiometer
- Signalling per NAMUR NE43, sensor break monitoring per NE89, EMC per NE21



Fig. left: head-mounted version, model T32.1S
Fig. right: rail-mounted version, model T32.3S

Description

These temperature transmitters are designed for universal use in the process industry. They offer high accuracy, galvanic isolation and excellent protection against electromagnetic influences (EMI). Via HART® protocol, the T32 temperature transmitters are configurable (interoperable) with a variety of open configuration tools. In addition to the different sensor types, e.g. sensors in accordance with DIN EN 60751, JIS C1606, DIN 43760, IEC 60584 or DIN 43710, customer-specific sensor characteristics can also be defined, through the input of value pairs (user-defined linearisation).

Through the configuration of a sensor with redundancy (dual sensor), on a sensor failure it will automatically change over to the working sensor. Furthermore, there is the possibility to activate sensor drift detection. With this, an error signalling occurs when the magnitude of the temperature difference between sensor 1 and sensor 2 exceeds a user-selectable value.

The T32 transmitter also has additional sophisticated supervisory functionality such as monitoring of the sensor lead resistance and sensor break monitoring in accordance with NAMUR NE89 as well as monitoring of the measuring range. Moreover, these transmitters have comprehensive cyclic self-monitoring functionality.

The dimensions of the head-mounted transmitter match the form B DIN connection heads with extended mounting space, e.g. WIKAI model BSS.

The transmitters in rail mounting cases are suitable for all standard rails in accordance with IEC 60715. The transmitters are delivered with a basic configuration or configured according to customer specifications.

Specifications

Measuring element					
Sensor type	Max. configurable measuring range ¹⁾	Standard	Minimum measuring span ¹⁴⁾	Typical measuring deviation ²⁾	Temperature coefficient per °C typical ³⁾
Pt100	-200 ... +850 °C	IEC 60751:2008	10 K or 3.8 Ω (greater value applies)	≤ ±0.12 °C ⁵⁾	≤ ±0.0094 °C ^{6) 7)}
Pt(x) ⁴⁾ 10 ... 1000	-200 ... +850 °C	IEC 60751:2008		≤ ±0.12 °C ⁵⁾	≤ ±0.0094 °C ^{6) 7)}
JPt100	-200 ... +500 °C	JIS C1606: 1989		≤ ±0.12 °C ⁵⁾	≤ ±0.0094 °C ^{6) 7)}
Ni100	-60 ... +250 °C	DIN 43760: 1987		≤ ±0.12 °C ⁵⁾	≤ ±0.0094 °C ^{6) 7)}
Resistance sensor	0 ... 8,370 Ω	-	4 Ω	≤ ±1.68 Ω ⁸⁾	≤ ±0.1584 Ω ⁸⁾
Potentiometer ⁹⁾	0 ... 100 %	-	10 %	≤ 0.50 % ¹⁰⁾	≤ ±0.0100 % ¹⁰⁾
TC type J (Fe-CuNi)	-210 ... +1,200 °C	IEC 60584-1: 1995	50 K or 2 mV (greater value applies)	≤ ±0.91 °C ¹¹⁾	≤ ±0.0217 °C ^{7) 11)}
TC type K (NiCr-Ni)	-270 ... +1,300 °C	IEC 60584-1: 1995		≤ ±0.98 °C ¹¹⁾	≤ ±0.0238 °C ^{7) 11)}
TC type L (Fe-CuNi)	-200 ... +900 °C	DIN 43760: 1987		≤ ±0.91 °C ¹¹⁾	≤ ±0.0203 °C ^{7) 11)}
TC type E (NiCr-Cu)	-270 ... +1,000 °C	IEC 60584-1: 1995		≤ ±0.91 °C ¹¹⁾	≤ ±0.0224 °C ^{7) 11)}
TC type N (NiCrSi-NiSi)	-270 ... +1,300 °C	IEC 60584-1: 1995		≤ ±1.02 °C ¹¹⁾	≤ ±0.0238 °C ^{7) 11)}
TC type T (Cu-CuNi)	-270 ... +400 °C	IEC 60584-1: 1995		≤ ±0.92 °C ¹¹⁾	≤ ±0.0191 °C ^{7) 11)}
TC type U (Cu-CuNi)	-200 ... +600 °C	DIN 43710: 1985		≤ ±0.92 °C ¹¹⁾	≤ ±0.0191 °C ^{7) 11)}
TC type R (PtRh-Pt)	-50 ... +1,768 °C	IEC 60584-1: 1995	150 K	≤ ±1.66 °C ¹¹⁾	≤ ±0.0338 °C ^{7) 11)}
TC type S (PtRh-Pt)	-50 ... +1,768 °C	IEC 60584-1: 1995	150 K	≤ ±1.66 °C ¹¹⁾	≤ ±0.0338 °C ^{7) 11)}
TC type B (PtRh-Pt)	0 ... +1,820 °C ¹⁵⁾	IEC 60584-1: 1995	200 K	≤ ±1.73 °C ¹¹⁾	≤ ±0.0500 °C ^{7) 12)}
mV sensor ¹⁶⁾	-500 ... +1,800 mV	-	4 mV	≤ ±0.33 mV ¹³⁾	≤ ±0.0311 mV ^{7) 13)}

Further information on: Measuring element	
Measuring current during measurement	Max. 0.3 mA (Pt100)
Connection methods	
Resistance thermometer (RTD)	1 sensor in 2-/4-/3-wire connection or 2 sensors in 2-wire connection → for further information, see "Designation of connection terminals"
Thermocouples (TC)	1 sensor or 2 sensors → for further information, see "Designation of connection terminals"
Max. lead resistance	
Resistance thermometer (RTD)	50 Ω each wire, 3-/4-wire
Thermocouples (TC)	5 kΩ each wire
Cold junction compensation, configurable	Internal compensation or external with Pt100, with thermostat or switched off

- 1) Other units e.g. °F and K possible
- 2) Measuring deviations (input + output) at ambient temperature 23 °C ±3 K, without influence of lead resistances; for example calculations, see page 4
- 3) Temperature coefficients (input + output) per °C
- 4) x configurable between 10 ... 1,000
- 5) Based on 3-wire Pt100, Ni100, 150 °C MV
- 6) Based on 150 °C MV
- 7) In the ambient temperature range -40 ... +85 °C
- 8) Based on a sensor with max. 5 kΩ
- 9) R_{total}: 10 ... 100 kΩ
- 10) Based on a potentiometer value of 50 %
- 11) Based on 400 °C MV with cold junction compensation error
- 12) Based on 1000 °C MV with cold junction compensation error
- 13) Based on measuring range 0 ... 1 V, 400 mV MV
- 14) The transmitter can be configured below these limit values, but this is not recommended due to loss of accuracy.
- 15) Specifications valid only for measuring range between 450 ... 1,820 °C
- 16) This operating mode is not allowed for SIL option (T32.xS.xxx-S).

Accuracy specifications				
Input + output in accordance with DIN EN 60770				
Input sensor type	Mean temperature coefficient (TC) for each 10 K change in ambient temperature in the range -40 ... +85 °C ¹⁾	Measuring deviation at reference conditions in accordance with DIN EN 60770, NE 145, valid at 23 °C ±3 K	Lead resistance effects	Long-term stability after 1 year
Pt100 ²⁾ / JPt100 / Ni100	±(0.06 K + 0.015 % MV)	-200 °C ≤ MV ≤ 200 °C: ±0.10 K MV > 200 °C: ±(0.1 K + 0.01 % IMV-200 Kl) ³⁾	4-wire: no effect (0 ... 50 Ω per wire)	±60 mΩ or 0.05 % of MV, greater value applies
Resistance sensor ⁵⁾	±(0.01 Ω + 0.01 % MV)	≤ 890 Ω: 0.053 Ω ⁶⁾ or 0.015 % MV ⁷⁾ ≤ 2140 Ω: 0.128 Ω ⁶⁾ or 0.015 % MV ⁷⁾ ≤ 4390 Ω: 0.263 Ω ⁶⁾ or 0.015 % MV ⁷⁾ ≤ 8380 Ω: 0.503 Ω ⁶⁾ or 0.015 % MV ⁷⁾	3-wire: ±0.02 Ω / 10 Ω (0 ... 50 Ω per wire) 2-wire: Resistance of the connection leads ⁴⁾	
Potentiometer ⁵⁾	±(0.1 % MV)	R _{part} /R _{total} is max. ±0.5 %	-	±20 μV or 0.05 % of MV, greater value applies
TC type J (Fe-CuNi)	MV > -150 °C: ±(0.07 K + 0.02 % IMV)	-150 °C < MV < 0 °C: ±(0.3 K + 0.2 % IMV) MV > 0 °C: ±(0.3 K + 0.03 % MV)	6 μV / 1,000 Ω ⁸⁾	±20 μV or 0.05 % of MV, greater value applies
TC type K (NiCr-Ni)	-150 °C < MV < 1,300 °C: ±(0.1 K + 0.02 % IMV)	-150 °C < MV < 0 °C: ±(0.4 K + 0.2 % IMV) 0 °C < MV < 1,300 °C: ±(0.4 K + 0.04 % MV)	6 μV / 1,000 Ω ⁸⁾	±20 μV or 0.05 % of MV, greater value applies
TC type L (Fe-CuNi)	-150 °C < MV < 0 °C: ±(0.07 K + 0.02 % IMV) MV > 0 °C: ±(0.07 K + 0.015 % MV)	-150 °C < MV < 0 °C: ±(0.3 K + 0.1 % IMV) MV > 0 °C: ±(0.3 K + 0.03 % MV)	6 μV / 1,000 Ω ⁸⁾	±20 μV or 0.05 % of MV, greater value applies
TC type E (NiCr-Cu)	MV > -150 °C: ±(0.1 K + 0.015 % IMV)	-150 °C < MV < 0 °C: ±(0.3 K + 0.2 % IMV) MV > 0 °C: ±(0.3 K + 0.03 % MV)	6 μV / 1,000 Ω ⁸⁾	±20 μV or 0.05 % of MV, greater value applies
TC type N (NiCrSi-NiSi)	-150 °C < MV < 0 °C: ±(0.1 K + 0.05 % IMV) MV > 0 °C: ±(0.1 K + 0.02 % MV)	-150 °C < MV < 0 °C: ±(0.5 K + 0.2 % IMV) MV > 0 °C: ±(0.5 K + 0.03 % MV)	6 μV / 1,000 Ω ⁸⁾	±20 μV or 0.05 % of MV, greater value applies
TC type T (Cu-CuNi)	-150 °C < MV < 0 °C: ±(0.07 K + 0.04 % MV) MV > 0 °C: ±(0.07 K + 0.01 % MV)	-150 °C < MV < 0 °C: ±(0.4 K + 0.2 % IMV) MV > 0 °C: ±(0.4 K + 0.01 % MV)	6 μV / 1,000 Ω ⁸⁾	±20 μV or 0.05 % of MV, greater value applies
TC type U (Cu-CuNi)	-150 °C < MV < 0 °C: ±(0.07 K + 0.04 % MV) MV > 0 °C: ±(0.07 K + 0.01 % MV)	-150 °C < MV < 0 °C: ±(0.4 K + 0.2 % IMV) MV > 0 °C: ±(0.4 K + 0.01 % MV)	6 μV / 1,000 Ω ⁸⁾	±20 μV or 0.05 % of MV, greater value applies
TC type R (PtRh-Pt)	50 °C < MV < 1,600 °C: ±(0.3 K + 0.01 % IMV - 400 Kl)	50 °C < MV < 400 °C: ±(1.45 K + 0.12 % IMV - 400 Kl) 400 °C < MV < 1,600 °C: ±(1.45 K + 0.01 % IMV - 400 Kl)	6 μV / 1,000 Ω ⁸⁾	±20 μV or 0.05 % of MV, greater value applies
TC type S (PtRh-Pt)	50 °C < MV < 1,600 °C: ±(0.3 K + 0.015 % IMV - 400 Kl)	50 °C < MV < 400 °C: ±(1.45 K + 0.12 % IMV - 400 Kl) 400 °C < MV < 1,600 °C: ±(1.45 K + 0.01 % IMV - 400 Kl)	6 μV / 1,000 Ω ⁸⁾	±20 μV or 0.05 % of MV, greater value applies
TC type B (PtRh-Pt)	450 °C < MV < 1,000 °C: ±(0.4 K + 0.02 % IMV - 1,000 Kl) MV > 1,000 °C: ±(0.4 K + 0.005 % (MV - 1,000 K))	450 °C < MV < 1,000 °C: ±(1.7 K + 0.2 % IMV - 1,000 Kl) MV > 1,000 °C: ±1.7 K	6 μV / 1,000 Ω ⁸⁾	±20 μV or 0.05 % of MV, greater value applies

Accuracy specifications				
Input + output in accordance with DIN EN 60770				
Input sensor type	Mean temperature coefficient (TC) for each 10 K change in ambient temperature in the range -40 ... +85 °C ¹⁾	Measuring deviation at reference conditions in accordance with DIN EN 60770, NE 145, valid at 23 °C ±3 K	Lead resistance effects	Long-term stability after 1 year
mV sensor ⁵⁾	2 µV + 0.02 % IMVI 100 µV + 0.08 % IMVI	≤ 1,160 mV: 10 µV + 0.03 % IMVI > 1,160 mV: 15 µV + 0.07 % IMVI	6 µV / 1,000 Ω ⁸⁾	±20 µV or 0.05 % of MV, greater value applies
Cold junction (only with TC)	±0.1 K	±0.8 K	-	±0.2 K
Output	±0.03 % of measuring span	±0.03 % of measuring span	-	±0.05 % of span

Further information on: Accuracy specifications	
Measuring rate (only for single RTD/TC sensors)	Typical, measured value update approx. 6/s
Influence of supply voltage	Not measurable
Effect of load	Not measurable

MV = measured value (temperature measured values in °C)
Measuring span = configured end of measuring range - configured start of measuring range

- 1) T32.1S: with the extended ambient temperature (-50 ... -40 °C) the value is doubled
- 2) For sensor Pt_x (x = 10 ... 1,000) applies: for x ≥ 100: permissible error, as for Pt100
for x < 100: permissible error, as for Pt100 with a factor (100/x)
- 3) Additional error for resistance thermometers in a 3-wire configuration with zero-balanced cable: 0.05 K
- 4) The specified resistance value of the sensor wire can be subtracted from the calculated sensor resistance.
Dual sensor: Configurable for each sensor separately
- 5) This operating mode is not allowed for SIL option (T32.xS.xxx-S).
- 6) Double value at 3-wire
- 7) Greater value applies
- 8) Within a range of 0 ... 10 kΩ lead resistance

Example calculation

Pt100 / 4-wire / Measuring range 0 ... 150 °C / Ambient temperature 33 °C	
Input Pt100, MV < 200 °C	±0.100 K
Output ±(0.03 % of 150 K)	±0.045 K
TC _{input} ±(0.06 K + 0.015 % of 150 K)	±0.083 K
TC _{output} ±(0.03 % of 150 K)	±0.045 K
Measuring deviation (typical) $\sqrt{\text{input}^2 + \text{output}^2 + \text{TC}_{\text{input}}^2 + \text{TC}_{\text{output}}^2}$	±0.145 K
Measuring deviation (maximum) (input + output + TC _{input} + TC _{output})	±0.273 K

Pt1000 / 3-wire / Measuring range -50 ... +50 °C / Ambient temperature 45 °C	
Input Pt1000, MV < 200 °C	±0.100 K
Output ±(0.03 % of 100 K)	±0.03 K
TC _{input} ±(0.06 K + 0.015 % of 100 K) * 2	±0.15 K
TC _{output} ±(0.03 % of 100 K) * 2	±0.06 K
Measuring deviation (typical) $\sqrt{\text{input}^2 + \text{output}^2 + \text{TC}_{\text{input}}^2 + \text{TC}_{\text{output}}^2}$	±0.19 K
Measuring deviation (maximum) (input + output + TC _{input} + TC _{output})	±0.34 K

Thermocouple type K / measuring range 0 ... 400 °C / internal compensation (cold junction) / ambient temperature 23 °C	
Input type K, 0 °C < MV < 1,300 °C ±(0.4 K + 0.04 % of 400 K)	±0.56 K
Cold junction ±0.8 K	±0.80 K
Output ±(0.03 % of 400 K)	±0.12 K
Measuring deviation (typical) $\sqrt{\text{input}^2 + \text{cold junction}^2 + \text{output}^2}$	±0.98 K
Measuring deviation (maximum) (input + cold junction + output)	±1.48 K

Output signal		
Analogue output (configurable)	<ul style="list-style-type: none"> ■ 4 ... 20 mA, 2-wire ■ 20 ... 4 mA, 2-wire 	
Temperature linearity	For RTD	Linear to temperature per IEC 60751, JIS C1606, DIN 43760
	For TC	Linear to temperature per IEC 60584, DIN 43710
Load R_A	The permissible load depends on the loop supply voltage.	
With HART®	$R_A \leq (U_B - 11.5 \text{ V}) / 0.023 \text{ A}$ with R _A in Ω and U _B in V	
Without HART®	$R_A \leq (U_B - 10.5 \text{ V}) / 0.023 \text{ A}$ with R _A in Ω and U _B in V	
Load diagram (without HART®)		
Output limits (configurable)		
In accordance with NAMUR NE43	Lower limit	3.8 mA
	Upper limit	20.5 mA
Customer-specifically adjustable	Lower limit	3.6 ... 4.0 mA
	Upper limit	20.0 ... 21.5 mA
Option SIL (model T32.xS.xxx-S)	Lower limit	3.8 ... 4.0 mA
	Upper limit	20.0 ... 20.5 mA
Current value for signalling		
In accordance with NAMUR NE43	Downscale	< 3.6 mA (3.5 mA)
	Upscale	> 21.0 mA (21.5 mA)
Setting range	Downscale	3.5 ... 3.6 mA
	Upscale	21.0 ... 22.5 mA
PV, primary value (digital HART® measured value)	Signalling on sensor and hardware error through default value In simulation mode, independent from input signal, simulation value configurable from 3.5 ... 23.0 mA	
Dampening (configurable)	Configurable between 1 ... 60 s (0 = disabled)	
Factory configuration		
Sensor	1 sensor	
Connection method	3-wire connection	
Measuring range	0 ... 150 °C	
Dampening	Disabled	
Output limits	Lower limit	3.8 mA
	Upper limit	20.5 mA
Current value for signalling	Downscale	< 3.6 mA (3.5 mA)
Communication		
Communication protocol	HART® protocol rev. 5 ¹⁾ including burst mode, multidrop	
	→ for further information, see page 15	
Configuration software	WIKA_T32	
	→ free download from www.wika.com	

Output signal		
Configuration	→ For connection example, see page 16	
User linearisation	Store customer-specific sensor characteristics in the transmitter using software (other sensor types can be used in this way) Number of data points: min. 2 / max. 30	
Sensor functionality when 2 sensors have been connected (dual sensor)	Transmitter can be configured below these limit values. This is not recommended due to loss of accuracy.	
	Sensor 1, sensor 2 redundant	The 4 ... 20 mA output signal delivers the process value of sensor 1. If sensor 1 fails, the process value of sensor 2 is output (sensor 2 is redundant).
	Mean value	The 4 ... 20 mA output signal delivers the mean value of the two values from sensor 1 and sensor 2. If one sensor fails, the process value of the error-free sensor is output.
	Minimum value	The 4 ... 20 mA output signal delivers the lower of the two values from sensor 1 and sensor 2. If one sensor fails, the process value of the error-free sensor is output.
	Maximum value	The 4 ... 20 mA output signal delivers the higher of the two values from sensor 1 and sensor 2. If one sensor fails, the process value of the error-free sensor is output.
	Difference ²⁾	The 4 ... 20 mA output signal delivers the difference between sensor 1 and sensor 2. If one sensor fails, an error signalling will be activated.
Monitoring functions		
Test current for sensor monitoring ³⁾	Nom. 20 µA during test cycle, otherwise 0 µA	
Monitoring NAMUR NE89 (monitoring of input lead resistance)	Resistance thermometer (Pt100, 4-wire)	$R_{L1} + R_{L4} > 100 \Omega$ with hysteresis 5 Ω $R_{L2} + R_{L3} > 100 \Omega$ with hysteresis 5 Ω
	Thermocouple	$R_{L1} + R_{L4} + R_{\text{thermocouple}} > 10 \text{ k}\Omega$ with hysteresis 100 Ω
	3-wire	Monitoring of the resistance difference between lead 3 and 4; an error will be indicated if there is a difference of > 0.5 Ω between leads 3 and 4
Sensor break monitoring	Always active	
Sensor short circuit monitoring	Active (only for resistance thermometers)	
Self-monitoring	Active permanently, e.g. RAM/ROM test, logical program operating checks and validity check	
Measuring range monitoring	Monitoring of the set measuring range for upper/lower deviations Standard: deactivated	
Monitoring functionality by connection of 2 sensors (dual sensor)	Redundancy	In the case of a sensor error (sensor break, lead resistance too high or outside the measuring range of the sensor) of one of the two sensors, the process value will be only based on the error-free sensor. Once the error is rectified, the process value will again be based on the two sensors, or on sensor 1.
	Ageing control (sensor drift monitoring)	An error signalling on the output is activated if the value of the temperature difference between sensor 1 and sensor 2 is higher than a set value, which can be selected by the user. This monitoring only generates a signal if two valid sensor values can be determined and the temperature difference is higher than the selected limit value. (Cannot be selected for the "Difference" sensor function, since the output signal already indicates the difference value).
Voltage supply		
Supply voltage U_B	DC 10.5 ... 42 V ⁴⁾ Attention: Restricted auxiliary power ranges for explosion-protected versions (see "Safety-related characteristic values")	

Output signal

Time response

Rise time t_{90}	Approx. 0.8 s
Switch-on time (time to get the first measured value)	Max. 15 s
Warm-up time	After approx. 5 minutes the instrument will function to the specifications (accuracy) given in the data sheet

1) Optional: Rev. 7

2) This operating mode is not allowed for SIL option (T32.xS.xxx-S).

3) Only for thermocouple

4) Supply voltage input protected against reverse polarity; Load $R_A \leq (U_B - 10.5 \text{ V}) / 0.023 \text{ A}$ with R_A in Ω and U_B in V (without HART®)

On switching on, an increase in the supply voltage of 2 V/s is needed; otherwise the temperature transmitter will remain in a safe condition at 3.5 mA.

Electrical connections

Wire cross-section

T32.1S head-mounted version	Solid wire	0.14 ... 2.5 mm ² (24 ... 14 AWG)
	Strand with end splice	0.14 ... 1.5 mm ² (24 ... 16 AWG)
T32.3S rail-mounted version	Solid wire	0.14 ... 2.5 mm ² (24 ... 14 AWG)
	Strand with end splice	0.14 ... 2.5 mm ² (24 ... 14 AWG)

Lead resistance

With resistance sensors	50 Ω each wire, 3-/4-wire
With thermocouples	5 k Ω each wire

Insulation voltage (input to analogue output)

AC 1,200 V, (50 Hz / 60 Hz); 1 s

Designation of connection terminals

Analogue output
4 ... 20 mA loop

Identical dual sensors are supported for all sensor types, i. e. dual sensor combinations as for example Pt100/Pt100 or thermocouple type K/type K are possible.
A further rule is that both sensor values have the same unit and the same sensor range.

Input resistance sensor/thermocouple

Thermocouple	Resistance thermometer/ resistance sensor	Potentiometer	Dual thermocouple Dual mV sensor	Dual resistance thermometer/ dual resistance sensor
Cold junction with external Pt100	in 4-wire 3-wire 2-wire		Sensor 1 Sensor 2	in 2+2-wire Sensor 1 Sensor 2

For the HART® modem, connection terminals are available for the head-mounted case and additional terminals are available for the rail-mounted case.

11234547.0X

Materials	
Non-wetted parts	
T32.1S head-mounted version	Plastic, PBT, glass-fibre reinforced
T32.3S rail-mounted version	Plastic

Operating conditions	
Ambient temperature	-60 ¹⁾ / -50 ²⁾ / -40 ... +85 °C
Storage temperature	-60 ¹⁾ / -50 ²⁾ / -40 ... +85 °C
Relative humidity, condensation	
T32.1S head-mounted version (in accordance with IEC 60068-2-38: 1974)	Test max. temperature variation 65 °C and -10 °C, 93 % ±3 % r. h.
T32.3S rail-mounted version (in accordance with IEC 60068-2-30: 2005)	Test max. temperature 55 °C, 95 % r. h.
Climate class per IEC 654-1: 1993	Cx (-40 ... +85 °C, 5 ... 95 % r. h.)
Salt fog per IEC 60068-2-52	Severity level 1
Vibration resistance per IEC 60068-2-6:2007	Test Fc: 10 ... 2,000 Hz; 10 g, amplitude 0.75 mm
Shock resistance per IEC 68-2-27: 1987	Test Ea: Acceleration type I 30 g and type II 100 g
Free-fall test following IEC 60721-3-2: 1997	Drop height 1,500 mm
Ingress protection of the entire instrument (in accordance with IEC/EN 60529)	
T32.1S head-mounted version	IP00 (electronics completely potted)
T32.3S rail-mounted version	IP20
Service life	Max. service life of 20 years (in line with ISO 13849-1)

- 1) Special version on request (only available with specific approvals), not for rail-mounted version T32.3S, not for SIL version
2) Special version, not for rail-mounted version T32.3S

Model T32.1R (option)	
Higher measuring rate	Measured value update approx. 14/s
Limited accuracy	Multiply the specified accuracy limit values for the T32.xS model by a factor of 2
Limited sensor diagnostics	Limited self-monitoring function
Sensor input	Only for thermocouples
SIL certification	Without
External cold junction	Without
Dual sensor function	Without

Approvals

Approvals included in the scope of delivery



Logo	Description	Country
CE	EU declaration of conformity	European Union
	EMC directive ¹⁾	
	EN 61326 emission (group 1, class B) and immunity (industrial application), and also NAMUR NE21	
	RoHS directive	

- 1) During interference take into account an increased measuring deviation of up to 1 %.

Optional approvals

Logo	Description	Country
	EU declaration of conformity ATEX directive Hazardous areas	European Union
	IECEX Hazardous areas	International
	FM Hazardous areas	USA
	CSA Hazardous areas	Canada
	EAC EMC directive Hazardous areas	Eurasian Economic Community
	GOST Metrology, measurement technology	Russia
-	MTSCHS Permission for commissioning	Kazakhstan
	BelGIM Metrology, measurement technology	Belarus
	UkrSEPRO Metrology, measurement technology	Ukraine
	DNOP - MakNII Mining Hazardous areas	Ukraine
	Uzstandard Metrology, measurement technology	Uzbekistan
	INMETRO Hazardous areas	Brazil
	NEPSI Hazardous areas	China
	KCs - KOSHA Hazardous areas	South Korea

Manufacturer's information and certificates

Logo	Description
	SIL 2 (option) Functional safety
-	China RoHS directive
	NAMUR <ul style="list-style-type: none"> ■ EMC per NAMUR NE21 ■ Signalling per NAMUR NE43 ■ Sensor break monitoring per NAMUR NE89

Certificates (option)

Certificates	
Certificates	<ul style="list-style-type: none"> ■ 2.2 test report ■ 3.1 inspection certificate
Calibration	DKD/DakkS calibration certificate

Approvals and certificates, see website

Safety-relevant characteristic values (explosion-protected version)

T32.1S.0IS, T32.3S.0IS

ATEX approval, IEC

Safety-related characteristic values (Ex)		
Ex marking	BVS 08 ATEX E 019 X BVS 08.0018X (IECEx certificate)	
T32.1S head-mounted version	Zones 0, 1	II 1G Ex ia IIC T4/T5/T6 Ga
	Zones 20, 21	II 1D Ex ia IIIC T120 °C Da
T32.3S rail-mounted version	Zones 0, 1	II 2(1)G Ex ia [ia Ga] IIC T4/T5/T6 Gb
	Zones 20, 21	II 2(1)D Ex ia [ia Da] IIIC T120 °C Db
Connection values / Intrinsically safe supply and signal circuit (4 ... 20 mA current loop)		
Terminals	+ / -	
Supply voltage U_B ¹⁾	DC 10.5 ... 30 V	
Maximum voltage U_i	DC 30 V	
Maximum current I_i	130 mA	
Maximum power P_i (gas)	800 mW	
Maximum power P_i (dust)	750/650/550 mW	
Effective internal capacitance C_i	7.8 nF	
Effective internal inductance L_i	100 µH	
Sensor circuit connection values		
Terminals	1 - 4	
Maximum voltage U_0	DC 6.5 V	
Maximum current I_0	9.3 mA	
Maximum power P_0	15.2 mW	
Effective internal capacitance C_i	208 nF	
Effective internal inductance L_i	Negligible	
Maximum external capacitance C_0	Gas, category 1 and 2, group IIC	24 µF ²⁾
	Gas, category 1 and 2, group IIA	1,000 µF ²⁾
	Category 1 and 2, gas IIB, dust IIIC	570 mH ²⁾
Maximum external inductance L_0	Gas, category 1 and 2, group IIC	365 mH
	Gas, category 1 and 2, group IIA	3,288 mH
	Category 1 and 2, gas IIB, dust IIIC	1,644 mH
Maximum inductance/resistance ratio L_0/R_0	Gas, category 1 and 2, group IIC	1.44 mH/Ω
	Gas, category 1 and 2, group IIA	11.5 µH/Ω
	Category 1 and 2, gas IIB, dust IIIC	5.75 mH/Ω
Characteristic curve	Linear	

Application	Ambient temperature range	Temperature class	Power P_i
Group II Gas, category 1 and 2	-50 ³⁾ / -40 ... +85 °C	T4	800 mW
	-50 ³⁾ / -40 ... +75 °C	T5	800 mW
	-50 ³⁾ / -40 ... +60 °C	T6	800 mW
Group IIIC Dust, category 1 + 2	-50 ³⁾ / -40 ... +40 °C	N / A	750 mW
	-50 ³⁾ / -40 ... +75 °C	N / A	650 mW
	-50 ³⁾ / -40 ... +100 °C	N / A	550 mW

1) Supply voltage input protected against reverse polarity; Load $R_A \leq (U_B - 10.5 \text{ V}) / 0.023 \text{ A}$ with R_A in Ω and U_B in V (without HART®)

On switching on, an increase in the supply voltage of 2 V/s is needed; otherwise the temperature transmitter will remain in a safe condition at 3.5 mA.

2) C_i already considered

3) Special version, not for rail-mounted version T32.3S

CSA and FM approval

Safety-related characteristic values (Ex)	CSA	FM
Ex marking	70038032	3034620 / FM17US0333X
Intrinsically safe installation (in accordance with drawing 11396220)	Class I, zone 0, Ex ia IIC Class I, zone 0, AEx ia IIC	Class I, zone 0, AEx ia IIC Class I, division 1, group A, B, C, D (only FM approval AEx ia)
Non-sparking field terminal (in accordance with drawing 11396220)	Class I, division 2, group A, B, C, D	Class I, division 2, group A, B, C, D Class I, division 2, IIC
Connection values / Intrinsically safe supply and signal circuit (4 ... 20 mA current loop)		
Terminals	+ / -	+ / -
Supply voltage U_B ¹⁾	DC 10.5 ... 30 V	DC 10.5 ... 30 V
Maximum voltage U_i	DC 30 V	DC 30 V
Maximum current I_i	130 mA	130 mA
Maximum power P_i (gas)	800 mW	800 mW
Maximum power P_i (dust)	750/650/550 mW	-
Effective internal capacitance C_i	7.8 nF	7.8 nF
Effective internal inductance L_i	100 μ H	100 μ H
Sensor circuit connection values		
Terminals	-	1 - 4
Maximum voltage V_{OC}	-	6.5 V
Maximum current I_{SC}	-	9.3 mA
Maximum power P_{max}	-	15.2 mW
Maximum external capacitance C_a	-	24 μ F
Maximum external inductance L_a	-	365 μ H

Application	Ambient temperature range		Temperature class	Power P_i
	CSA	FM		
Class I	-50 ²⁾ / -40 ... +85 °C	-50 ²⁾ / -40 ... +85 °C	T4	800 mW
	-50 ²⁾ / -40 ... +75 °C	-50 ²⁾ / -40 ... +75 °C	T5	800 mW
	-50 ²⁾ / -40 ... +60 °C	-50 ²⁾ / -40 ... +60 °C	T6	800 mW
Class IIIC	-50 ²⁾ / -40 ... +40 °C	-50 ²⁾ / -40 ... +85 °C	T4	750 mW
	-50 ²⁾ / -40 ... +75 °C	-50 ²⁾ / -40 ... +75 °C	T5	650 mW
	-50 ²⁾ / -40 ... +100 °C	-50 ²⁾ / -40 ... +60 °C	T6	550 mW

1) Supply voltage input protected against reverse polarity; Load $R_A \leq (U_B - 10.5 \text{ V}) / 0.023 \text{ A}$ with R_A in Ω and U_B in V (without HART®)

On switching on, an increase in the supply voltage of 2 V/s is needed; otherwise the temperature transmitter will remain in a safe condition at 3.5 mA.

2) Special version, not for rail-mounted version T32.3S

Safety-related characteristic values (Ex)

Ex marking	RU C-DE.ГБ08.B.02485, intrinsically safe equipment 0 Ex ia IIC T4/T5/T6 1 Ex ib IIC T4/T5/T6 2 Ex ic IIC T4/T5/T6 Ex nA II T4/T5/T6 DIP A20 Ta 120 °C DIP A21 Ta 120 °C
-------------------	---

Connection values / Intrinsically safe supply and signal circuit (4 ... 20 mA current loop)

Terminals	+ / -
Supply voltage U_B ¹⁾	DC 10.5 ... 30 V
Maximum voltage V_{max}	DC 30 V
Maximum current I_{max}	130 mA
Maximum power P_i	800 mW
Effective internal capacitance C_i	7.8 nF
Effective internal inductance L_i	100 μ H

Sensor circuit connection values

Terminals	1 - 4
Maximum voltage V_{oc}	6.5 V
Maximum current I_{sc}	9.3 mA
Maximum power P_{max}	15.2 mW
Maximum external capacitance C_a	IIC 24 μ F
	IIB 570 μ F
Maximum external inductance L_a	IIC 365 μ H
	IIB 1,644 μ H

Application	Ambient temperature range	Temperature class
Class IIC	-60 ²⁾ / -50 ³⁾ / -40 ... +85 °C	T4
Class IIB	-60 ²⁾ / -50 ³⁾ / -40 ... +75 °C	T5
	-60 ²⁾ / -50 ³⁾ / -40 ... +60 °C	T6

1) Supply voltage input protected against reverse polarity; Load $R_A \leq (U_B - 10.5 \text{ V}) / 0.023 \text{ A}$ with R_A in Ω and U_B in V (without HART®)

On switching on, an increase in the supply voltage of 2 V/s is needed; otherwise the temperature transmitter will remain in a safe condition at 3.5 mA.

2) Special version on request (only available with specific approvals), not for rail-mounted version T32.3S, not for SIL version

3) Special version, not for rail-mounted version T32.3S

T32.1S.0NI, T32.3S.0NI

ATEX approval, IEC

Safety-related characteristic values (Ex)	
Ex marking	II 3G Ex nA IIC T4/T5/T6 Gc X
Connection values / Intrinsically safe supply and signal circuit (4 ... 20 mA current loop)	
Terminals	+ / -
Supply voltage U_B ¹⁾	DC 10.5 ... 40 V
Maximum voltage U_N	DC 40 V
Maximum current I_N	23 mA ²⁾
Maximum power P_{max}	1 W
Sensor circuit connection values	
Terminals	1 - 4
Maximum voltage U_{max}	DC 3.1 V
Maximum current I_{max}	0.26 mA
Maximum power P_{max}	15.2 mW

Application	Ambient temperature range	Temperature class
Group IIC	-50 ³⁾ / -40 ... +85 °C	T4
	-50 ³⁾ / -40 ... +75 °C	T5
	-50 ³⁾ / -40 ... +60 °C	T6

1) Supply voltage input protected against reverse polarity; Load $R_A \leq (U_B - 10.5 \text{ V}) / 0.023 \text{ A}$ with R_A in Ω and U_B in V (without HART®)

On switching on, an increase in the supply voltage of 2 V/s is needed; otherwise the temperature transmitter will remain in a safe condition at 3.5 mA.

2) The maximum operating current is limited by the T32. The maximum current of the associated energy-limited equipment should not be $\leq 23 \text{ mA}$.

3) Special version, not for rail-mounted version T32.3S

T32.1S.0IC, T32.3S.0IC

ATEX approval, IEC

Safety-related characteristic values (Ex)		
Ex marking	II 3G Ex ic IIC T4/T5/T6 Gc	
Connection values / Intrinsically safe supply and signal circuit (4 ... 20 mA current loop)		
Terminals	+ / -	
Supply voltage U_B ¹⁾	DC 10.5 ... 30 V	
Maximum voltage U_i	DC 30 V	
Maximum current I_i	130 mA	
Maximum power P_i	800 mW	
Effective internal capacitance C_i	7.8 nF	
Effective internal inductance L_i	100 μ H	
Sensor circuit connection values		
Terminals	1 - 4	
Maximum voltage U_0	DC 6.5 V	
Maximum current I_0	9.3 mA	
Maximum power P_0	15.2 mW	
Effective internal capacitance C_i	208 nF	
Effective internal inductance L_i	Negligible	
Maximum external capacitance C_0	Gas IIC	$\leq 325 \mu\text{F}$ ³⁾
	Gas IIA	$\leq 1,000 \mu\text{F}$ ³⁾
	Gas IIB, dust IIIC	$\leq 570 \mu\text{F}$ ³⁾
Maximum external inductance L_0	Gas IIC	$\leq 821 \text{ mH}$
	Gas IIA	$\leq 7,399 \text{ mH}$
	Gas IIB, dust IIIC	$\leq 3,699 \text{ mH}$
Maximum inductance/resistance ratio L_0/R_0	Gas IIC	$\leq 3.23 \text{ mH}/\Omega$
	Gas IIA	$\leq 25.8 \text{ mH}/\Omega$
	Gas IIB, dust IIIC	$\leq 12.9 \text{ mH}/\Omega$
Characteristic curve	Linear	

Application	Ambient temperature range	Temperature class	Power P_i
Group II Gas, category 1 and 2	-50 ³⁾ / -40 ... +85 °C	T4	800 mW
	-50 ³⁾ / -40 ... +75 °C	T5	800 mW
	-50 ³⁾ / -40 ... +60 °C	T6	800 mW

1) Supply voltage input protected against reverse polarity; Load $R_A \leq (U_B - 10.5 \text{ V}) / 0.023 \text{ A}$ with R_A in Ω and U_B in V (without HART®)
On switching on, an increase in the supply voltage of 2 V/s is needed; otherwise the temperature transmitter will remain in a safe condition at 3.5 mA.

2) Special version, not for rail-mounted version T32.3S

3) Ci already considered

Dimensions in mm

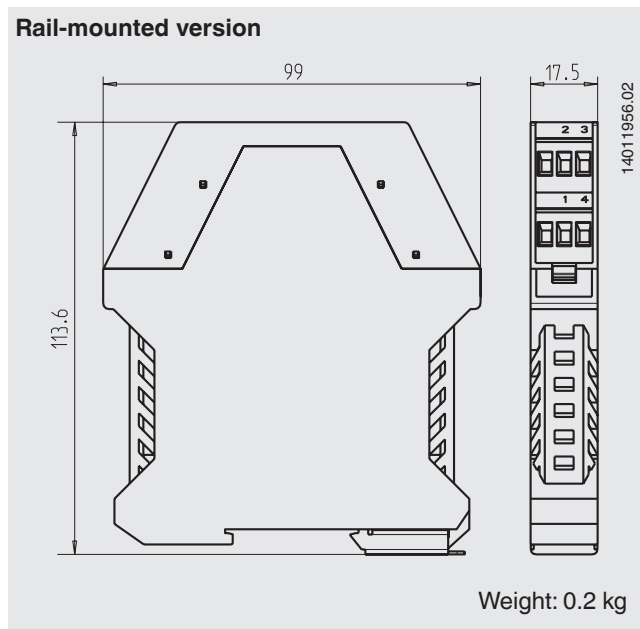
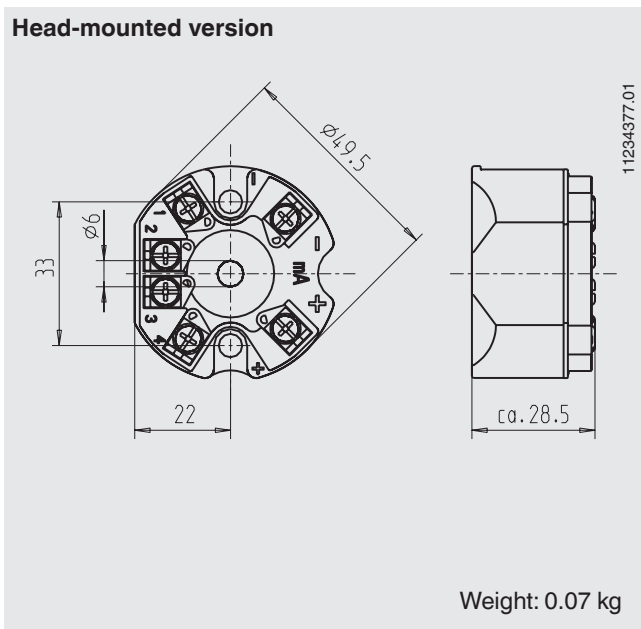

Communication

HART® protocol rev. 5 ¹⁾ including burst mode, multidrop

Interoperability (i.e. compatibility between components from different manufacturers) is a strict requirement of HART® instruments. The T32 transmitter is compatible with almost every open software and hardware tool; including:

1. User-friendly WIKA configuration software, free-of-charge download from www.wika.com
2. HART® communicator FC375, FC475, MFC4150, MFC5150, Trex:
T32 device description (device object file) is integrated and upgradable with old versions
3. Asset management systems
 - 3.1 AMS: T32_DD completely integrated and upgradable with old versions
 - 3.2 Simatic PDM: T32_EDD completely integrated from version 5.1, upgradable with version 5.0.2
 - 3.3 Smart Vision: DTM upgradable per FDT 1.2 standard from SV version 4
 - 3.4 PACTware: DTM completely integrated and upgradable as well as all supporting applications with FDT 1.2 interface
 - 3.5 Field Mate: DTM upgradeable

Attention:

For direct communication via the serial interface of a PC/notebook, a HART® modem is needed (see "Accessories"). As a general rule, parameters which are defined in the scope of the universal HART® commands (e.g. the measuring range) can, in principle, be edited with all HART® configuration tools.

1) Optional: Rev. 7

Configuration

Typical connection in hazardous area

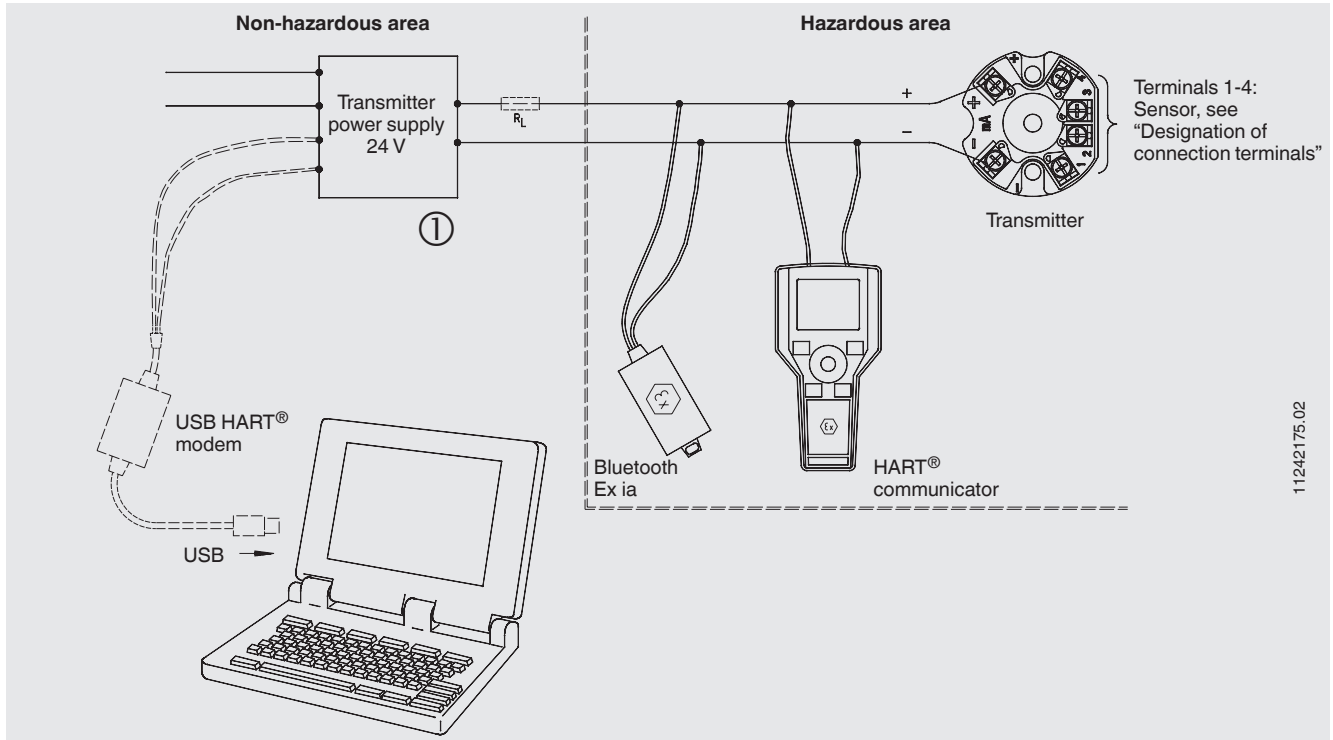

Typical connection in non-hazardous area

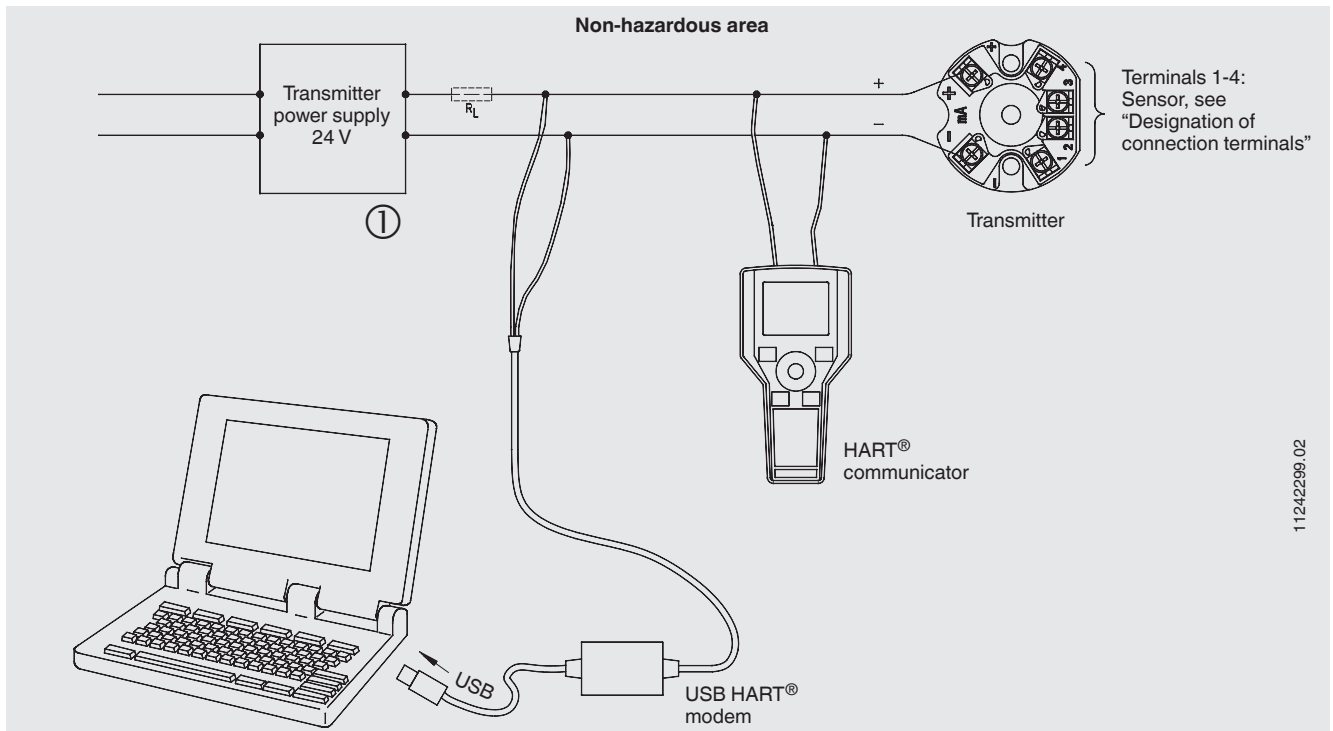





① RL = Load resistance for HART® communication
RL min. 250 Ω, max. 1,100 Ω

If RL is < 250 Ω in the respective electric circuit, RL must be increased to at least 250 Ω by connecting external resistors.





In the event of a fault, at very high ambient temperatures, with downscale error signaling and with unfavourable loads, communication may occasionally be impaired.

Accessories

DIH50-F with field case, adapter

Model	Description	Order number
	DIH50, DIH52 with field case DIH50 indication module without separate auxiliary supply voltage, automatically rescales on a change in measuring range and units via supervision of the HART® communication, 5-digit LC display, 20-segment bar graph display, display rotatable in 10° steps, with II 1G Ex ia IIC explosion protection; see data sheet AC 80.10 Material: Aluminium / stainless steel Dimensions: 150 x 127 x 138 mm	on request
	Adapter Suitable for TS 35 per DIN EN 60715 (DIN EN 50022) or TS 32 per DIN EN 50035 Material: Plastic / stainless steel Dimensions: 60 x 20 x 41.6 mm	3593789
	Adapter Suitable for TS 35 per DIN EN 60715 (DIN EN 50022) Material: Steel, tin-plated Dimensions: 49 x 8 x 14 mm	3619851
	Magnetic quick connector, model magWIK Replacement for crocodile clips and HART® terminals Fast, safe and tight electrical connection For all configuration and calibration processes	14026893

HART® modem

Model	Description	Order number
Programming unit, model PU-H		
	VIATOR® HART® USB HART® modem for USB interface	11025166
	VIATOR® HART® USB PowerXpress™ HART® modem for USB interface	14133234
	VIATOR® HART® RS-232 HART® modem for RS-232 interface	7957522
	VIATOR® HART® Bluetooth® Ex HART® modem for Bluetooth interface, Ex	11364254

Ordering information

Model / Explosion protection / SIL specifications / Configuration / Permissible ambient temperature / Certificates / Options

© 04/2008 WIKA Alexander Wiegand SE & Co. KG, all rights reserved.
The specifications given in this document represent the state of engineering at the time of publishing.
We reserve the right to make modifications to the specifications and materials.

WIKA data sheet TE 32.04 · 11/2020

Page 18 of 18

Your WIKA Sales Partner



ICS Schneider Messtechnik GmbH

Briesestrasse 59

D-16562 Hohen Neuendorf / OT Bergfelde

Tel.: +49 3303 5040-66

Fax: +49 3303 5040-68

E-Mail: info@ics-schneider.de



WIKA Alexander Wiegand SE & Co. KG

Alexander-Wiegand-Straße 30

63911 Klingenberg/Germany

Tel. +49 9372 132-0

Fax +49 9372 132-406

info@wika.de

www.wika.de