

Measuring insert For resistance thermometer with flameproof enclosure (TR10-L) Model TR10-K

WIKA data sheet TE 60.11



for further approvals
see page 2

Applications

- Replacement measuring insert for servicing

Special features

- Sensor ranges from -196 ... +600 °C [-320 ... +1,112 °F]
- Made of mineral-insulated sheathed measuring cable
- For all standard thermowell designs
- Spring-loaded design
- Explosion-protected versions are available for many approval types (see page 2)

Description

The measuring inserts for resistance thermometers described here are designed for installation in a thermometer model TR10-L. Operation without thermowell is appropriate only in special cases. The measuring insert is made of flexible, mineral-insulated sheathed cable. The sensor is located in the tip of the measuring insert. The measuring inserts are delivered with pressure springs to ensure that the measuring inserts are pressed down to the thermowell bottom.

The following versions are possible:

- With mounted sleeve to suit inner diameter of the thermowell
- Without terminal block
- With transmitter

Type and number of sensors, accuracy and connection method can each be selected to suit the respective application.



Measuring insert, model TR10-K

Only correct measuring insert length and correct measuring insert diameter ensure sufficient heat transfer from thermowell to the measuring insert.

A large number of different explosion-protected approvals are available for the TR10-K.

The range of applications is completed by designs without terminal block for direct transmitter installation. Optionally, analogue or digital transmitters from the WIKA range can be installed.











Explosion protection (option)



Attention:

The measuring insert model TR10-K is designed for use in resistance thermometer model TR10-L only.

The ignition protection type Ex d is guaranteed only if the measuring insert including the supplied threaded sleeve (flameproof joint) is built into the connection head with flameproof enclosure of the resistance thermometer model TR10-L.

Approvals (explosion protection, further approvals)

Logo	Description	Country
	EU declaration of conformity <ul style="list-style-type: none"> ■ EMC directive ¹⁾ EN 61326 emission (group 1, class B) and immunity (industrial application) ■ RoHS directive ■ ATEX directive (option) Hazardous areas - Ex i Zone 0 gas II 1G Ex ia IIC T1 ... T6 Ga Zone 1 gas II 2G Ex ia IIC T1 ... T6 Gb 	European Union
		
	IECEx (option) - in conjunction with ATEX Hazardous areas - Ex i Zone 0 gas Ex ia IIC T1 ... T6 Ga Zone 1 gas Ex ia IIC T1 ... T6 Gb	International
	EAC (option) Hazardous areas - Ex i Zone 0 gas 0Ex ia IIC T6 ... T1 Ga X	Eurasian Economic Community
	Ex Ukraine (option) Hazardous areas - Ex i Zone 0 gas II 1G Ex ia IIC T1 ... T6 Ga	Ukraine
	INMETRO (option) Hazardous areas - Ex i Zone 0 gas Ex ia IIC T3 ... T6 Ga Zone 1 gas Ex ia IIC T3 ... T6 Gb	Brazil
	CCC (option) ²⁾ Hazardous areas - Ex i Zone 0 gas Ex ia IIC T1 ~ T6 Ga - Ex e Zone 1 Gas Ex e IIC T1 ~ T6 Gb - Ex n Zone 2 Gas Ex nA IIC T1 ~ T6 Gc	China
	KCs - KOSHA (option) Hazardous areas - Ex i Zone 0 gas Ex ia IIC T4...T6 Zone 1 gas Ex ib IIC T4 ... T6	South Korea
-	PESO (option) Hazardous areas - Ex i Zone 0 gas Ex ia IIC T1...T6 Ga Zone 1 gas Ex ia IIC T1...T6 Gb	India
	GOST (option) Metrology, measurement technology	Russia
	KazInMetr (option) Metrology, measurement technology	Kazakhstan

Logo	Description	Country
-	MTSCHS (option) Permission for commissioning	Kazakhstan
	BelGIM (option) Metrology, measurement technology	Belarus
	UkrSEPRO (option) Metrology, measurement technology	Ukraine
	Uzstandard (option) Metrology, measurement technology	Uzbekistan

1) Only for built-in transmitter
2) Without transmitter

Instruments marked with “ia” may also be used in areas only requiring instruments marked with “ib” or “ic”.
If an instrument with “ia” marking has been used in an area with requirements in accordance with “ib” or “ic”, it can no longer be operated in areas with requirements in accordance with “ia” afterwards.

Approvals and certificates, see website

Sensor

Measuring element

Pt100 (measuring current: 0.1 ... 1.0 mA) ¹⁾

Connection method	
Single elements	1 x 2-wire 1 x 3-wire 1 x 4-wire
Dual elements	2 x 2-wire 2 x 3-wire 2 x 4-wire ²⁾

Validity limits of class accuracy per EN 60751		
Class	Sensor construction	
	Wire-wound	Thin-film
Class B	-196 ... +600 °C	-50 ... +500 °C
Class A ³⁾	-100 ... +450 °C	-30 ... +300 °C
Class AA ³⁾	-50 ... +250 °C	0 ... 150 °C

1) For detailed specifications for Pt100 sensors, see Technical information IN 00.17 at www.wika.de.

2) Not with 3 mm diameter

3) Not with 2-wire connection method

The table shows the temperature ranges listed in the respective standards, in which the tolerance values (class accuracies) are valid.

Electrical connection (colour code per IEC/EN 60751)

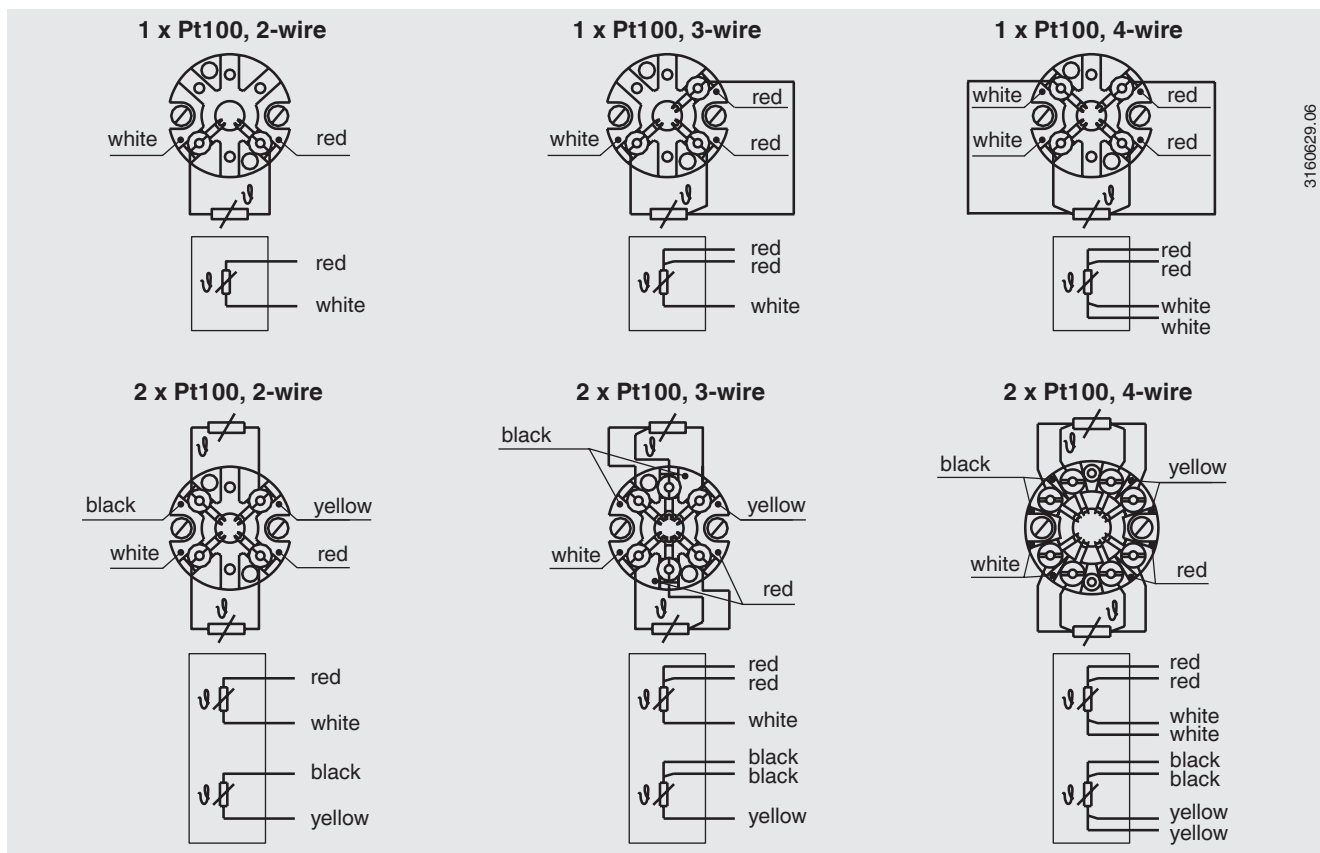

For the electrical connections of built-in temperature transmitters see the corresponding data sheets or operating instructions.

Transmitter (option)

A transmitter can be built upon the measuring insert. In this case, the transmitter replaces the terminal block and is directly attached to the terminal plate of the measuring insert.



Output signal 4 ... 20 mA, HART® protocol			
Transmitter (selectable versions)	Model T15	Model T32	Model T91.10
Data sheet	TE 15.01	TE 32.04	TE 91.01
Output			
4 ... 20 mA	x	x	x
HART® protocol	-	x	-
Connection method			
1 x 2-wire, 3-wire or 4-wire	x	x	x
Measuring current	< 0.2 mA	< 0.3 mA	0.8 ... 1 mA
Explosion protection	Optional	Optional	-

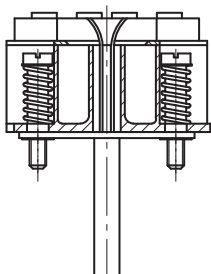

Measuring insert with mounted transmitter
(here: Model T32)

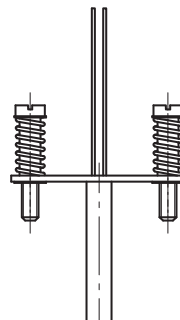

Measuring insert prepared for transmitter mounting

Functional safety (option) with temperature transmitter model T32



In safety-critical applications, the entire measuring chain must be taken into consideration in terms of the safety parameters. The SIL classification allows the assessment of the risk reduction achieved by the safety installations.

Selected TR10-K measuring inserts in combination with a suitable temperature transmitter (e.g. model T32.1S, TÜV certified SIL version for protection systems developed in accordance with IEC 61508) are suitable as sensors for safety functions to SIL 2.

Suitable thermowells allow easy dismantling of the measuring insert for calibration. The optimally matched measuring point consists of a thermowell, a thermometer with built-in TR10-K measuring insert and a T32.1S transmitter developed in accordance with IEC 61508. Thus, the measuring point provides maximum reliability and a long service life.

Dimensions in mm

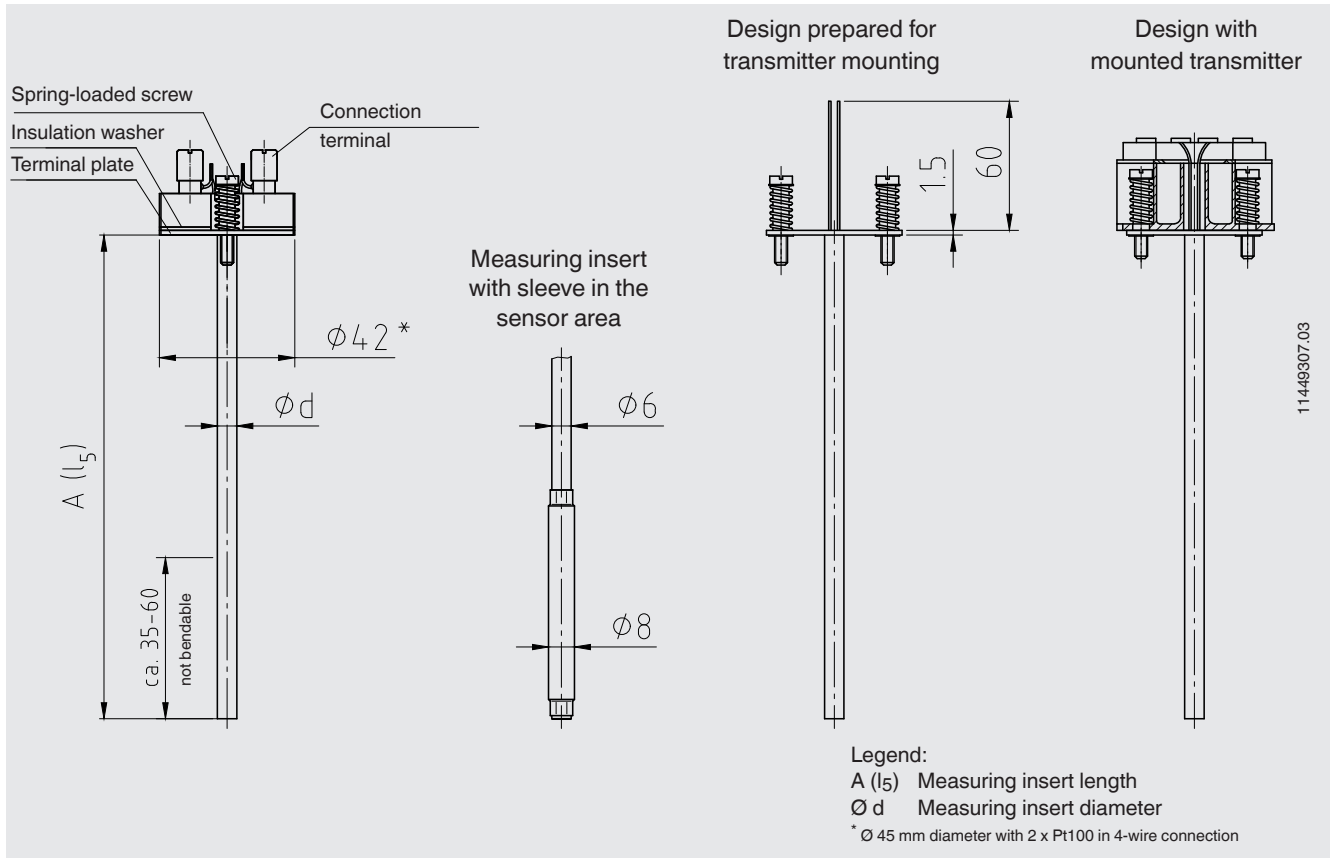

Measuring insert length l_5 in mm	Tolerance in mm
75 ... 825	+2 0
> 825	+3 0

Please note:

Max. measuring insert length = 1,100 mm

Only on explicit request do we deliver measuring inserts with lengths of greater than 1,100 mm in a stretched, straight form.

To specify this in the order, please contact your WIKA contact person.

Measuring insert diameter ϕd in mm	Index per DIN 43735	Tolerance in mm
3 ¹⁾	Standard	30
3	Standard	3 ± 0.05
6	Standard	60
6	Standard	$6 \begin{smallmatrix} 0 \\ -0,1 \end{smallmatrix}$
8 (6 mm with sleeve)	Standard	-
8	Standard	$8 \begin{smallmatrix} 0 \\ -0,1 \end{smallmatrix}$
8	Standard	$8 \begin{smallmatrix} 0 \\ -0,1 \end{smallmatrix}$
1/8 in [3.17 mm] ¹⁾ 1/4 in [6.35 mm] 3/8 in [9.53 mm]	On request	-

1) Not possible with 2 x Pt100, 4-wire

Measuring insert

The measuring insert is made of a vibration-resistant, sheathed measuring cable (MI cable).
The measuring insert diameter should be approx. 1 mm smaller than the bore diameter of the thermowell.
Gaps of more than 0.5 mm between thermowell and the measuring insert will have a negative effect on the heat transfer, and they will result in unfavourable response behaviour of the thermometer.

Using two screws and springs, the measuring insert can be mounted into a connection head (with flameproof enclosure, models 1/4000, 7/8000), replaceable and mounted spring-loaded.

When fitting the measuring insert into a thermowell, it is very important to determine the correct insertion length (= thermowell length for bottom thicknesses of ≤ 5.5 mm). In order to ensure that the measuring insert is firmly pressed down onto the bottom of the thermowell, the insert must be spring-loaded (spring travel: max 10 mm).

The standard material used for the measuring insert sheath is stainless steel. Other materials on request.

Besides twistability, this series is characterised by a high vibration resistance of the probe tip (6 g peak-to-peak¹⁾).

1) In combination with TR10-L, vibration resistance data of the TR10-L apply.

Attention:

Operation of the model TR10-K measuring instrument is not permitted in hazardous areas without flame path and connection head with flameproof enclosure!

Flame path

A flame path is built into the connection head which, in conjunction with the measuring insert, generates a flameproof joint.

If servicing is required, we recommend replacing the flame path together with the measuring insert.

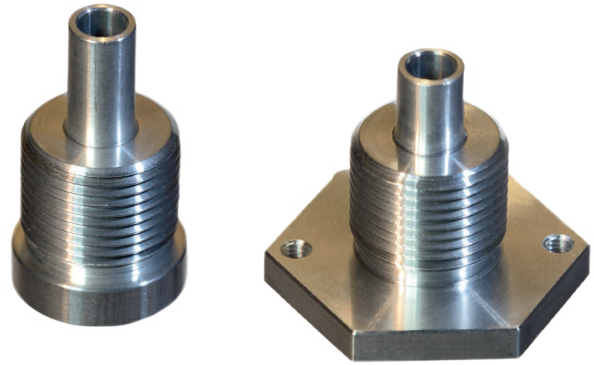

Fig. left: Flame path for model 1/4000 connection head
Fig. right: Flame path for model 7/8000 connection head and 7/8000 with DIH50

Certificates (option)

Certification type	Measurement accuracy	Material certificate
2.2 test report	x	x
3.1 inspection certificate	x	x
DKD/DAkkS calibration certificate	x	-

The different certifications can be combined with each other.

The minimum length for carrying out a measurement accuracy test 3.1 or DKD/DAkkS is 100 mm.
Calibration of shorter lengths on request.

Ordering information

Model / Explosion protection / Measuring insert design / Terminal block, transmitter / Measuring element / Sensor connection method / Connection head / Temperature range / Probe tip design / Probe diameter / Sheath, tube material / Measuring insert length / Certificates / Options

© 03/2013 WIKA Alexander Wiegand SE & Co. KG, all rights reserved.
The specifications given in this document represent the state of engineering at the time of publishing.
We reserve the right to make modifications to the specifications and materials.

WIKA data sheet TE 60.11 · 02/2021

Page 7 of 7

Your WIKA Sales Partner



ICS Schneider Messtechnik GmbH
Briesestrasse 59
D-16562 Hohen Neuendorf / OT Bergfelde
Tel.: +49 3303 5040-66
Fax: +49 3303 5040-68
E-Mail: info@ics-schneider.de



WIKAL
WIKAL Alexander Wiegand SE & Co. KG
Alexander-Wiegand-Straße 30
63911 Klingenberg/Germany
Tel. +49 9372 132-0
Fax +49 9372 132-406
info@wika.de
www.wika.de