

Thermocouple For additional thermowell Model TC10-B

WIKA data sheet TE 65.02



for further Approvals,
see page 15

Applications

- Machine building, plant and vessel construction
- Energy and power plant technology
- Chemical industry
- Food and beverage industry
- Sanitary, heating and air-conditioning technology

Special features

- Sensor ranges from $-40 \dots +1,200 \text{ }^{\circ}\text{C}$ [$-40 \dots +2,192 \text{ }^{\circ}\text{F}$]
- For mounting in all standard thermowell designs
- Spring-loaded measuring insert (replaceable)
- Explosion-protected versions are available for many approval types

Description

Thermocouples in this series can be combined with a large number of thermowell designs. Operation without thermowell is only recommended in certain applications.

A wide variety of possible combinations of sensor, connection head, insertion length, neck length, connection to thermowell etc. are available for the thermometers; suitable for any thermowell dimension and any application.

A large number of different explosion-protected approvals are available for the TC10-B.

Optionally we can fit analogue or digital transmitters from the WIKA range into the connection head of the TC10-B.



Fig. left: Model TC10-B with BSZ connection head
Fig. right: Model TC10-B with 1/4000 connection head

Representation of the components

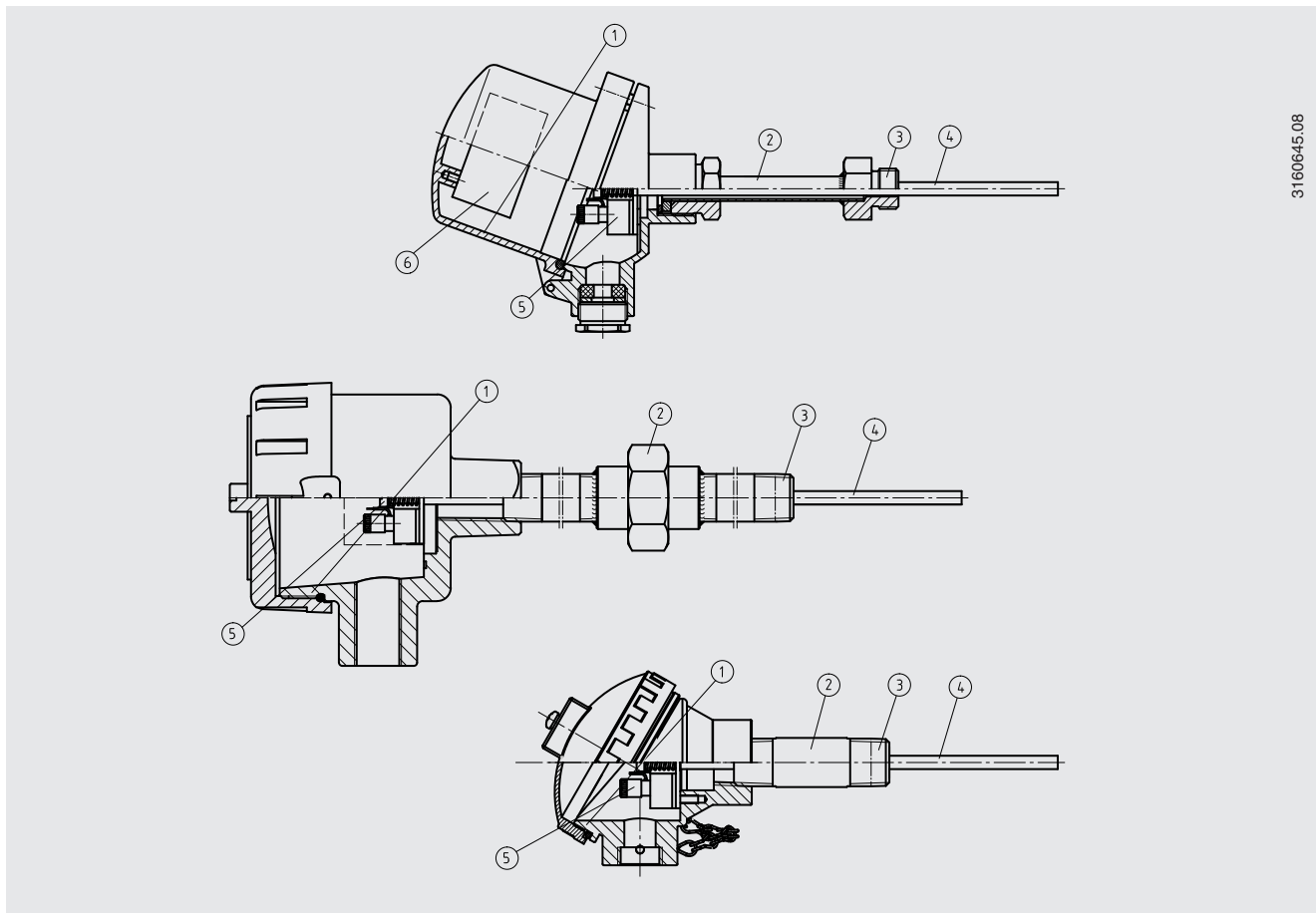

3160645.08

Legend:

- ① Connection head
- ② Neck tube
- ③ Connection to thermowell
- ④ Measuring insert (TC10-A)
- ⑤ Terminal block/transmitter (option)
- ⑥ Transmitter (option)

Overview of approvals for explosion protection

Approval	Explosion protection				
	Ex i (gas) Zone 0, 1, 2	Ex i (dust) Zone 20, 21, 22	Ex e (gas) Zone 1, 2	Ex t (dust) Zone 21, 22	Ex nA (gas) Zone 2
ATEX	x	x	x	x	x
IECEX	x	x	x	x	x
EAC	x	x	-	-	x
Ex Ukraine	x	x	-	-	-
INMETRO	x	x	-	-	-
CCC	x	x	x	-	-
KCs	x	-	-	-	-
PESO	x	-	-	-	-

→ For detailed information, see „Approvals“ on page 15

Measuring element

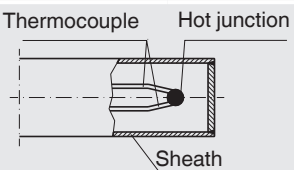
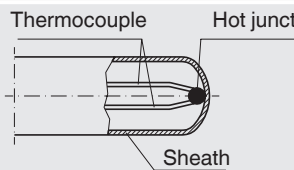
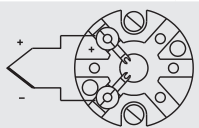
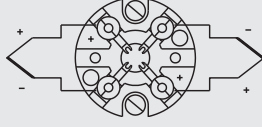
Measuring element		
Type of measuring element	Thermocouple per IEC 60584-1 or ASTM E230 Types K, J, E, N, T	
Probe tip design (hot junction)	Ungrounded (hot junction welded isolated, standard)	Grounded (hot junction not isolated, welded to the bottom)
		
Marking of the polarity	The colour coding at the positive poles of the instrument decides the correlation of polarity and terminal	
Single thermocouple		
Dual thermocouple		
Validity limits of the class accuracy in accordance with IEC 60584-1		
Type K	Class 2	-40 ... +1,200 °C [-40 ... +2,192 °F]
	Class 1	-40 ... +1,000 °C [-40 ... +1,832 °F]
Type J	Class 2	-40 ... +750 °C [-40 ... +1,382 °F]
	Class 1	-40 ... +750 °C [-40 ... +1,382 °F]
Type E	Class 2	-40 ... +900 °C [-40 ... +1,652 °F]
	Class 1	-40 ... +800 °C [-40 ... +1,472 °F]
Type N	Class 2	-40 ... +1,200 °C [-40 ... +2,192 °F]
	Class 1	-40 ... +1,000 °C [-40 ... +1,832 °F]
Type T	Class 2	-40 ... +350 °C [-40 ... +662 °F]
	Class 1	-40 ... +350 °C [-40 ... +662 °F]
Validity limits of the class accuracy in accordance with ASTM-E230		
Type K	Standard	0 ... 1,260 °C [32 ... 2,300 °F]
	Special	0 ... 1,260 °C [32 ... 2,300 °F]
Type J	Standard	0 ... 760 °C [32 ... 1,400 °F]
	Special	0 ... 760 °C [32 ... 1,400 °F]
Type E	Standard	0 ... 870 °C [32 ... 1,598 °F]
	Special	0 ... 870 °C [32 ... 1,598 °F]
Type N	Standard	0 ... 1,260 °C [32 ... 2,300 °F]
	Special	0 ... 1,260 °C [32 ... 2,300 °F]
Type T	Standard	0 ... 370 °C [32 ... 698 °F]
	Special	0 ... 370 °C [32 ... 698 °F]

→ For detailed specifications for thermocouples, see IEC 60584-1 or ASTM E230 and Technical information IN 00.23 at www.wika.com.



The table shows the temperature ranges listed in the respective standards, in which the tolerance values (class accuracies) are valid.

The actual operating temperature of the thermometer is limited both by the maximum permissible operating temperature and the diameter of the thermocouple and the sheathed cable, as well as by the maximum permissible working temperature of the thermowell material.

For the tolerance value of thermocouples, a cold junction temperature of 0 °C [32 °F] has been taken as the basis.

Connection head

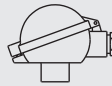
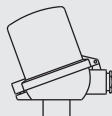
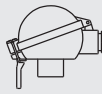
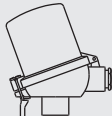
■ European designs per EN 50446 / DIN 43735

Model	Material	Cable inlet thread size	Ingress protection (max.) ¹⁾ IEC/EN 60529	Cap	Surface	Connection to neck tube	
 BS	Aluminium	■ M20 x 1.5 ■ ½ NPT	IP65 ³⁾	Flat cover with 2 screws	Blue, painted (RAL 5022)	■ M24 x 1.5 ■ ½ NPT	
 BSZ	Aluminium	■ M20 x 1.5 ■ ½ NPT	IP65 ³⁾	Spherical hinged cover with cylinder head screw	Blue, painted (RAL 5022)	■ M24 x 1.5 ■ ½ NPT	
	BSZ-K	Plastic	■ M20 x 1.5 ■ ½ NPT	IP65	Spherical hinged cover with cylinder head screw	Black	M24 x 1.5
 BSZ-H	Aluminium	■ M20 x 1.5 ■ ½ NPT	IP65 ³⁾	Raised hinged cover with cylinder head screw	Blue, painted (RAL 5022)	■ M24 x 1.5 ■ ½ NPT	
	BSZ-H (2 x cable outlet)	Aluminium	■ 2 x M20 x 1.5 ■ 2 x ½ NPT	IP65 ³⁾	Raised hinged cover with cylinder head screw	Blue, painted (RAL 5022)	M24 x 1.5
	BSZ-H / DIH10²⁾	Aluminium	■ M20 x 1.5 ■ ½ NPT	IP65	Raised hinged cover with cylinder head screw	Blue, painted (RAL 5022)	■ M24 x 1.5 ■ ½ NPT
	BSZ-HK	Plastic	■ M20 x 1.5 ■ ½ NPT	IP65	Raised hinged cover with cylinder head screw	Black	M24 x 1.5
 BSS	Aluminium	■ M20 x 1.5 ■ ½ NPT	IP65	Spherical hinged cover with clamping lever	Blue, painted (RAL 5022)	■ M24 x 1.5 ■ ½ NPT	
 BSS-H	Aluminium	■ M20 x 1.5 ■ ½ NPT	IP65	Raised hinged cover with clamping lever	Blue, painted (RAL 5022)	■ M24 x 1.5 ■ ½ NPT	
 BVS	Stainless steel	M20 x 1.5	IP65	Precision-cast screw-on lid	Natural finish, electropolished	M24 x 1.5	

Further thread sizes on request

Model	Explosion protection					
	Without	Ex i (gas) Zone 0, 1, 2	Ex i (dust) Zone 20, 21, 22	Ex e (gas) Zone 1, 2	Ex t (dust) Zone 21, 22	Ex nA (gas) Zone 2
BS	x	x	x	-	-	-
BSZ	x	x	x	x ⁴⁾	x ⁴⁾	x ⁵⁾
BSZ-H	x	x	x	x ⁴⁾	x ⁴⁾	x ⁵⁾
BSZ-H (2 x cable outlet)	x	x	x	x ⁴⁾	x ⁴⁾	x ⁵⁾
BSZ-H / DIH10²⁾	x	x	-	-	-	-
BSS	x	x	-	-	-	-
BSS-H	x	x	-	-	-	-
BVS	x	x	-	-	-	-
BSZ-K	x	x	-	-	-	-
BSZ-HK	x	x	-	-	-	-

1) IP ingress protection of the connection head. The IP ingress protection of the complete TC10-B instrument does not necessarily have to correspond to the connection head.







2) LED display DIH10

3) Ingress protections, describing temporary or permanent immersion, on request

4) Only ATEX

5) Only ATEX and EAC

■ International connection heads

Model	Material	Cable inlet thread size	Ingress protection (max.) ¹⁾ IEC/EN 60529	Cap	Surface	Connection to neck tube	
	KN4-A	Aluminium	■ ½ NPT ■ M20 x 1.5	IP65 ³⁾	Screw-on lid	Blue, painted (RAL 5022)	■ M24 x 1.5 ■ ½ NPT
	KN4-P ²⁾	Polypropylene	½ NPT	IP65 ³⁾	Screw-on lid	White	½ NPT
	1/4000 F	Aluminium	■ ½ NPT ■ ¾ NPT ■ M20 x 1.5	IP66 ³⁾	Screw-on lid	Blue, painted (RAL 5022)	½ NPT
	1/4000 S	Stainless steel	■ ½ NPT ■ ¾ NPT ■ M20 x 1.5	IP66 ³⁾	Screw-on lid	Natural finish	½ NPT
	7/8000 W	Aluminium	■ ½ NPT ■ ¾ NPT ■ M20 x 1.5	IP66 ³⁾	Screw-on lid	Blue, painted (RAL 5022)	½ NPT
	7/8000 S	Stainless steel	■ ½ NPT ■ ¾ NPT ■ M20 x 1.5	IP66 ³⁾	Screw-on lid	Natural finish	½ NPT
	7/8000 W / DIH50 ⁴⁾	Aluminium	■ ½ NPT ■ ¾ NPT ■ M20 x 1.5	IP66 ³⁾	Screw-on lid	Blue, painted (RAL 5022)	½ NPT
	7/8000 S / DIH50 ⁴⁾	Stainless steel	■ ½ NPT ■ ¾ NPT ■ M20 x 1.5	IP66 ³⁾	Screw-on lid	Natural finish	½ NPT
	PIH-L ⁵⁾	Aluminium	■ ½ NPT / closed ■ M20 x 1.5 / closed ■ 2 x ½ NPT ■ 2 x M20 x 1.5	IP66 ³⁾	Screw-on lid, flat	Blue upper body, painted (RAL 5022) Grey lower body, painted (RAL 7032)	■ ½ NPT ■ M20 x 1.5
	PIH-H ⁵⁾	Aluminium	■ ½ NPT ■ M20 x 1.5 ■ 2 x ½ NPT ■ 2 x M20 x 1.5	IP66 ³⁾	Screw-on lid, high	Blue upper body, painted (RAL 5022) Grey lower body, painted (RAL 7032)	■ ½ NPT ■ M20 x 1.5

Model	Explosion protection					
	Without	Ex i (gas) Zone 0, 1, 2	Ex i (dust) Zone 20, 21, 22	Ex e (gas) Zone 1, 2	Ex t (dust) Zone 21, 22	Ex nA (gas) Zone 2
KN4-A	x	x	-	-	-	-
KN4-P ²⁾	x	-	-	-	-	-
1/4000 F	x	x	x	x	x	x
1/4000 S	x	x	x	x	x	x
7/8000 W	x	x	x	x	x	x
7/8000 S	x	x	x	x	x	x
7/8000 W / DIH50 ⁴⁾	x	x	x	-	-	-
7/8000 S / DIH50 ⁴⁾	x	x	x	-	-	-
PIH-L / PIH-H ⁵⁾	x	x	x	x	x	x

1) IP ingress protection of the connection head. The IP ingress protection of the complete TC10-B instrument does not necessarily have to correspond to the connection head.

2) On request

3) Suitable sealing/cable gland required

4) LC display DIH50

5) Available from Q2/2023

Connection head with digital display













Connection head BSZ-H with LED display model DIH10
→ see data sheet AC 80.11



Connection head 7/8000 W with LC display model DIH50
→ see data sheet AC 80.10

To operate the digital displays, a transmitter with a 4 ... 20 mA output is always required.

Cable inlet

Cable inlet	Colour	Ingress protection (max.) IEC/EN 60529 ¹⁾	Cable inlet thread size	Min./max. ambient temperature
	Natural finish	IP65	<ul style="list-style-type: none"> ■ M20 x 1.5 ■ ½ NPT 	-40 ... +80 °C [-40 ... +176 °F]
	<ul style="list-style-type: none"> ■ Black ■ Grey 	IP66 ³⁾	<ul style="list-style-type: none"> ■ M20 x 1.5 ■ ½ NPT 	-40 ... +80 °C [-40 ... +176 °F]
	<ul style="list-style-type: none"> ■ Light blue ■ Black 	IP66 ³⁾	<ul style="list-style-type: none"> ■ M20 x 1.5 ■ ½ NPT 	<ul style="list-style-type: none"> ■ -20 ... +80 °C [-4 ... +176 °F] ■ -40 ... +70 °C [-40 ... +158 °F]
	Natural finish	IP66 ³⁾	<ul style="list-style-type: none"> ■ M20 x 1.5 ■ ½ NPT 	-60 ⁴⁾ / -40 ... +80 °C [-76 / -40 ... +176 °F]
	Natural finish	IP66 ³⁾	<ul style="list-style-type: none"> ■ M20 x 1.5 ■ ½ NPT 	-60 ⁴⁾ / -40 ... +80 °C [-76 / -40 ... +176 °F]
	Natural finish	IP66 ³⁾	<ul style="list-style-type: none"> ■ M20 x 1.5 ■ ½ NPT 	-60 ⁴⁾ / -40 ... +80 °C [-76 / -40 ... +176 °F]
	Natural finish	IP66 ³⁾	<ul style="list-style-type: none"> ■ M20 x 1.5 ■ ½ NPT 	-60 ⁴⁾ / -40 ... +80 °C [-76 / -40 ... +176 °F]
	-	IP00	<ul style="list-style-type: none"> ■ M20 x 1.5 ■ ½ NPT 	-
	-	IP00	<ul style="list-style-type: none"> ■ 2 x M20 x 1.5 ■ 2 x ½ NPT 	-
	-	IP65	M20 x 1.5	-40 ... +80 °C [-40 ... +176 °F]
	Transparent	-	<ul style="list-style-type: none"> ■ M20 x 1.5 ■ ½ NPT 	-40 ... +80 °C [-40 ... +176 °F]

- 1) IP ingress protection of the cable gland. The IP protection of the complete TC10-B instrument does not necessarily have to correspond to the cable gland.
- 2) Not available for BVS connection head
- 3) Ingress protections, describing temporary or permanent immersion, on request
- 4) Special version on request (explosion-protected versions only available with specific approvals)
- 5) Only for BSZ-H connection head
- 6) Not available for ½ NPT thread size cable entry

Cable inlet	Explosion protection					
	With-out	Ex i (gas) Zone 0, 1, 2	Ex i (dust) Zone 20, 21, 22	Ex e (gas) Zone 1, 2	Ex t (dust) Zone 21, 22	Ex nA (gas) Zone 2
Standard cable inlet ¹⁾	x	x	-	-	-	-
Plastic cable gland ¹⁾	x	x	-	-	-	-
Plastic cable gland (light blue), Ex e ¹⁾	x	x	x	-	-	-
Plastic cable gland (black), Ex e ¹⁾	x	x	x	x	x	x
Brass cable gland, nickel-plated	x	x	x	-	-	-
Brass cable gland, nickel-plated, Ex e	x	x	x	x	x	x
Stainless steel cable gland	x	x	x	-	-	-
Stainless steel cable gland, Ex e	x	x	x	x	x	x
Plain threaded	x	x	x ⁵⁾	x ⁵⁾	x ⁵⁾	x ⁵⁾
2 x plain threaded ²⁾	x	x	x ⁵⁾	x ⁵⁾	x ⁵⁾	x ⁵⁾
Junction socket M12 x 1 (4-pin) ³⁾	x	x ⁴⁾	x ⁴⁾	-	-	-
Sealing plugs for shipping	Not applicable, transport protection ⁵⁾					

- 1) Not available for BVS connection head
2) Only for BSZ-H connection head
3) Not available for ½ NPT thread size cable entry
4) With appropriate mating connector connected
5) Suitable cable gland required for operation

Measuring insert

Measuring insert		
Versions	Vibration-resistant sheathed mineral insulated cable (MI cable, MIMS)	
Standard	Standard soldering lugs	
Option	Recessed soldering lugs	
Optimal heat transfer	Requirement <ul style="list-style-type: none"> ■ Correct measuring insert length ■ Correct measuring insert diameter 	
	Bore diameter of the thermowell	Max. 1 mm [0.039 in] larger than the measuring insert diameter
	Gap width	With gap widths > 0.5 mm [0.020 in] between thermowell and measuring insert: → Negative impact on heat transfer → Unfavourable response behaviour of the thermometer
Insertion length	When fitting the measuring insert into a thermowell, it is very important to determine the correct insertion length (= thermowell length for bottom thicknesses of ≤ 5.5 mm [0.217 in]). In order to ensure that the measuring insert is firmly pressed down onto the bottom of the thermowell, the insert must be spring-loaded (spring travel: max. 10 mm [0.394 in]).	
Spring travel	Max. 10 mm [0.394 in]	

Dimensions in mm [in]

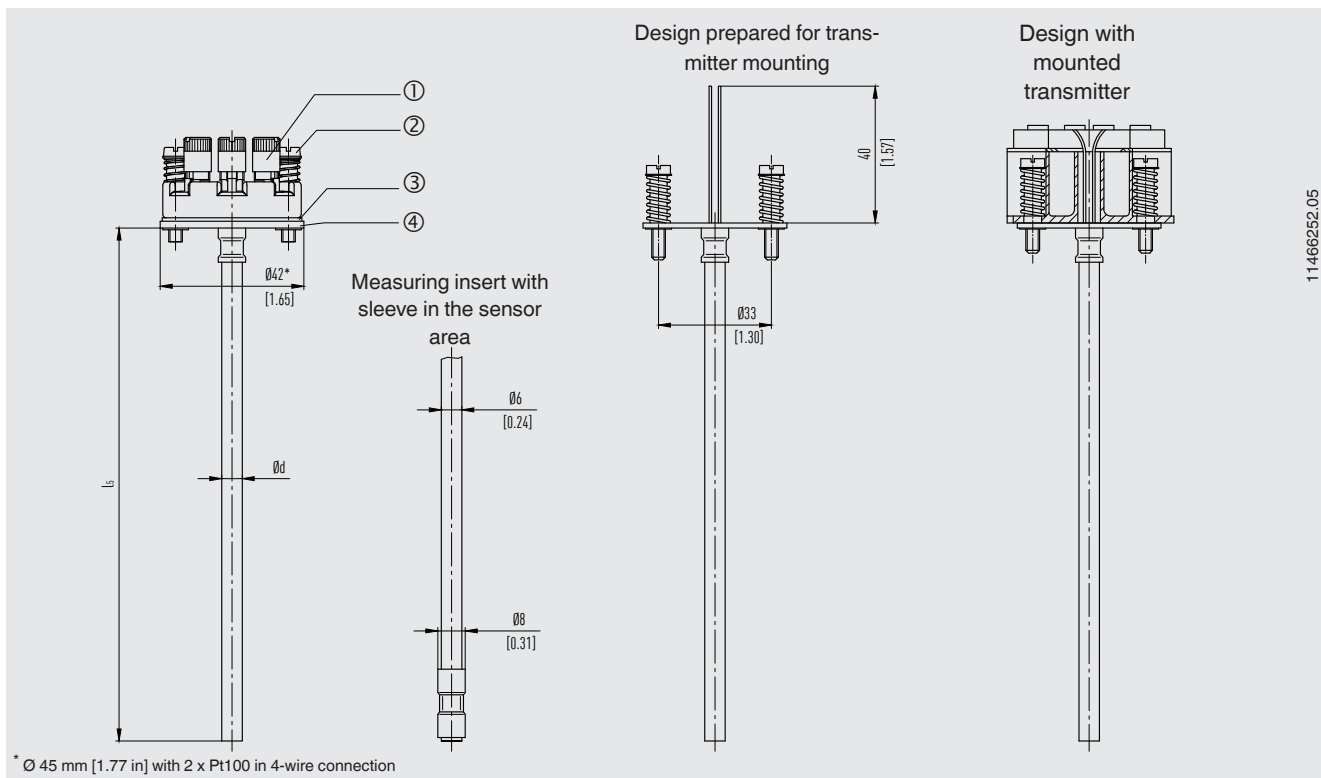

11466252.05

Legend



- ① Connection terminal
- ② Spring-loaded screw
- ③ Insulation washer
- ④ Terminal plate

Measuring insert diameter Ø d in mm		Index per DIN 43735	Tolerance in mm	Sheath material
3 [0.118 in]	Standard	30	3 ±0.05	<ul style="list-style-type: none"> ■ Alloy 600 ■ 1.4571 ■ 316L
6 [0.236 in]	Standard	60	6 ⁰ / _{-0.1}	
8 [0.315 in] (6 mm [0.236 in] with sleeve)	Standard	-	8 ⁰ / _{-0.1}	<ul style="list-style-type: none"> ■ Alloy 600 ■ 1.4571
8 [0.315 in]	Standard	80	8 ⁰ / _{-0.1}	<ul style="list-style-type: none"> ■ Alloy 600 ■ 1.4571 ■ 316L

Legend:

- l₅ Measuring insert length
- Ø d Measuring insert diameter

Transmitter

Transmitter models	Model T16	Model T32
Transmitter data sheet	TE 16.01	TE 32.04
Figure		
Output		
4 ... 20 mA	x	x
HART® protocol	-	x
Input	<ul style="list-style-type: none"> ■ Type K ■ Type J ■ Type E ■ Type N ■ Type T 	<ul style="list-style-type: none"> ■ Type K ■ Type J ■ Type E ■ Type N ■ Type T
Explosion protection	Option	Option
Mounting types		
Mounting onto the measuring insert	With mounting on the measuring insert, the transmitter replaces the terminal block and is fixed directly to the terminal plate of the measuring insert.	
Mounted within the cover of the connection head	Mounting the transmitter in the cover of the connection head is preferable to mounting it on the measuring insert. With this type of mounting, for one, a better thermal insulation is ensured, and in addition, exchange and mounting for servicing is simplified.	

Mounting types

Mounting onto the measuring insert



Measuring insert with mounted transmitter (here: Model T32)

Measuring insert prepared for transmitter mounting

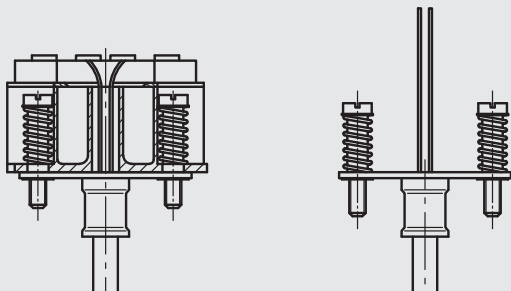

Mounted within the cover of the connection head

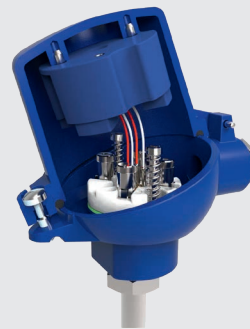

When using dual sensors in conjunction with a single transmitter, sensor 1 is connected to the transmitter. The connection leads of sensor 2 (insulated against short circuits) protrude loosely into the connection head.

The exception is the combination of a double thermocouple in conjunction with a T32 transmitter in the “redundancy” configuration. In this case, both sensors are connected to the T32.

Possible mounting positions for transmitters	Model T16	Model T32
BS	○	-
BSZ	○	○
BSZ-H	●	●
BSZ-H (2x cable outlet)	●	●
BSZ-H / DIH10	○	○
BSS	○	○
BSS-H	●	●
BVS	○	○
BSZ-K	○	○
BSZ-HK	●	●
KN4-A	○	○
KN4-P	○	○
1/4000	○	○
7/8000	○	○
7/8000 / DIH50	○	○
PIH-L / PIH-H	○	○

Legend:

- Mounted instead of terminal block
- Mounted within the cover of the connection head
- Mounting not possible

The mounting of a transmitter on the measuring insert is possible with all the connection heads listed here. The fitting of a transmitter in the (screw) cap of a connection head is not possible. Mounting of 2 transmitters on request.

For a correct determination of the overall measuring deviation, the sensor and transmitter measuring deviations must be added.

Functional safety with model T32 temperature transmitter (option)



In safety-critical applications, the entire measuring chain must be taken into consideration in terms of the safety parameters. The SIL classification allows the assessment of the risk reduction achieved by the safety installations.

Selected TC10-B resistance thermometers, in combination with a suitable temperature transmitter (e.g. model T32.1S, TÜV certified SIL version for protection systems developed in accordance with IEC 61508), are suitable as sensors for safety functions to SIL 2.

For SIL 3 applications, WIKA recommends the use of two individual TC10-B with one SIL-certified T32 transmitter connected to each.

→ Functional safety: Safety-relevant temperature measurement per IEC 61508 available at www.wika.de.

Neck tube

Versions

Neck tube design	Diameter	Connection to head	Connection to thermowell	Material
Neck tube per DIN 43772	<ul style="list-style-type: none"> ■ 12 x 1.5 mm [0.472 x 0.059 in] ■ 12 x 2.5 mm [0.472 x 0.098 in] 	M24 x 1.5 (swivel connection)	<ul style="list-style-type: none"> ■ Mounting thread ■ Compression fitting ■ Union nut ■ Male nut ■ Without threaded connection, plain 	1.4571
	14 x 2.5 mm [0.551 x 0.098 in]	M24 x 1.5 (swivel connection)	<ul style="list-style-type: none"> ■ Mounting thread ■ Union nut ■ Male nut 	1.4571
Neck tube with counter nut to head	14 x 2.5 mm [0.551 x 0.098 in]	M20 x 1.5 (with counter nut)	Mounting thread	1.4571
Double threaded hex bushing (with hexagonal spanner flats)	-	M24 x 1.5, ½ NPT	Mounting thread	1.4571
“Nipple-union-nipple” neck tube (nipple-union-nipple)	~ 22 mm [~ 0.9 in]	½ NPT	Mounting thread	316
	~ 27 mm [~ 1.1 in]	¾ NPT	Mounting thread	316
Double threaded hex bushing (tube section)	~ 22 mm [~ 0.9 in]	½ NPT	Mounting thread	316
	~ 27 mm [~ 1.1 in]	¾ NPT	Mounting thread	316

Thread sizes

Neck tube design	Diameter	Thread to the thermowell
Neck tube per DIN 43772	<ul style="list-style-type: none"> ■ 12 x 1.5 mm [0.472 x 0.059 in] ■ 12 x 2.5 mm [0.472 x 0.098 in] 	<ul style="list-style-type: none"> ■ G ½ B ■ G ¾ B ■ G ¼ B ■ M20 x 1.5 ■ M18 x 1.5 ■ M14 x 1.5 ■ ½ NPT ■ ¾ NPT ■ G ½ B compression fitting (metal ferrule) ■ G ¾ B compression fitting (metal ferrule) ■ M18 x 1.5 compression fitting (metal ferrule) ■ M20 x 1.5 compression fitting (metal ferrule) ■ G ½ B union nut ■ G ¾ B union nut ■ M20 x 1.5 union nut ■ G ½ B male nut ■ G ¾ B male nut ■ M20 x 1.5 male nut ■ Without threaded connection, plain
Neck tube per DIN 43772	14 x 2.5 mm [0.551 x 0.098 in]	<ul style="list-style-type: none"> ■ G ½ B ■ G ¾ B ■ G ¼ B ■ M20 x 1.5 ■ M18 x 1.5 ■ M14 x 1.5 ■ ½ NPT ■ ¾ NPT ■ G ½ B union nut ■ G ¾ B union nut ■ M20 x 1.5 union nut ■ G ½ B male nut ■ G ¾ B male nut ■ M20 x 1.5 male nut

Neck tube design	Diameter	Thread to the thermowell
Neck tube with counter nut to head	14 x 2.5 mm [0.551 x 0.098 in]	<ul style="list-style-type: none"> ■ ½ NPT ■ ¾ NPT ■ G ½ B ■ G ¾ B ■ G ¼ B ■ M14 x 1.5 ■ M18 x 1.5 ■ M20 x 1.5
Double threaded hex bushing (with hexagonal spanner flats)	-	<ul style="list-style-type: none"> ■ G ½ B ■ G ¾ B ■ G ¼ B ■ ½ NPT ■ ¾ NPT ■ M14 x 1.5 ■ M18 x 1.5 ■ M20 x 1.5
“Nipple-union-nipple” neck tube	~ 22 mm [~ 0.9 in]	½ NPT
	~ 27 mm [~ 1.1 in]	¾ NPT
Double threaded hex bushing (tube section)	~ 22 mm [~ 0.9 in]	½ NPT
	~ 27 mm [~ 1.1 in]	¾ NPT

Neck lengths

Neck tube design	Neck length	Min. / Max. neck length
Neck tube per DIN 43772	150 mm [~ 6 in]	<ul style="list-style-type: none"> ■ 30 mm [~ 1.2 in] ■ 500 mm [~ 20 in]
Neck tube per DIN 43772, plain	150 mm [~ 6 in]	<ul style="list-style-type: none"> ■ 75 mm [~ 3 in] ■ 900 mm [~ 35 in]
Neck tube with counter nut to head	150 mm [~ 6 in]	<ul style="list-style-type: none"> ■ 75 mm [~ 3 in] ■ 250 mm [~ 10 in]
Double threaded hex bushing (with hexagonal spanner flats)		
M24 x 1.5 to connection head, parallel thread to thermowell	13 mm [0.512 in]	-
1/2 NPT to connection head, parallel thread to thermowell	~ 25 mm [1 in]	-
M24 x 1.5 to connection head, tapered thread to thermowell	~ 25 mm [1 in]	-
1/2 NPT to connection head, tapered thread to thermowell	~ 25 mm [1 in]	-
“Nipple-union-nipple” neck tube	~ 150 mm [6 in]	<ul style="list-style-type: none"> ■ ~ 75 mm [3 in] ■ ~ 250 mm [10 in]
Double threaded hex bushing (tube section)	~ 50 mm [2 in]	<ul style="list-style-type: none"> ■ ~ 50 mm [2 in] ■ ~ 250 mm [10 in]

The neck tube is screwed into the connection head. The neck length depends on the intended use. Usually an isolation is bridged by the neck tube. Also, in many cases, the neck tube serves as a cooling element between the connection head and the medium, in order to protect a possible built-in transmitter from high medium temperatures.

Other versions on request.

Operating conditions

Operating conditions	
Ambient and storage temperature	-60 ¹⁾ / -40 ... +80 °C
Vibration resistance	50 g (probe tip)
	The information on vibration resistance refers to the tip of the measuring insert.

IP ingress protection per IEC/EN 60529

First index number	Degree of protection / Short description	Test parameters
Degrees of protection against solid foreign bodies (defined by the 1st index number)		
5	Dust-protected	Per IEC/EN 60529
6	Dust-tight	Per IEC/EN 60529
Degrees of protection against water (defined by the 2nd index number)		
4	Protected against splash water	Per IEC/EN 60529
5	Protected against water jets	Per IEC/EN 60529
6	Protected against strong water jets	Per IEC/EN 60529
7 ²⁾	Protected against the effects of temporary immersion in water	Per IEC/EN 60529
8 ²⁾	Protected against the effects of permanent immersion in water	As agreed upon

1) Special version on request (explosion-protected versions only available with specific approvals)







2) Ingress protections, describing temporary or permanent immersion, on request

Standard ingress protection of the model TC10-B is IP65.

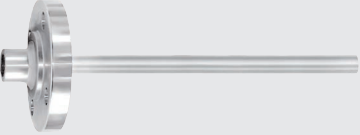
The specified degrees of protection apply under the following conditions:

- Use of a suitable thermowell
(without suitable thermowell: IP40)
- Use of a suitable cable gland
- Use of a cable cross-section appropriate for the gland or select the appropriate cable gland for the available cable
- Adhere to the tightening torques for all threaded connections

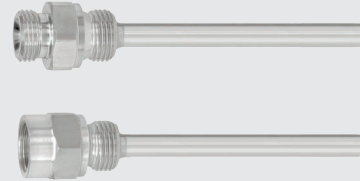
Thermowell (option)

Thermowell selection		
Illustration	Model	Data sheet
	TW10	<ul style="list-style-type: none"> ■ TW 95.10 ■ TW 95.11 ■ TW 95.12
	TW15	TW 95.15
	TW20	TW 95.20
	TW25	TW 95.25
	TW30	TW 95.30
	TW45	TW 95.45
	TW50	TW 95.50
	TW55	TW 95.55

Special thermowells on request.





Approvals









Approvals included in the scope of delivery

Logo	Description	Country
	EU declaration of conformity	European Union
	EMC directive ¹⁾ EN 61326 emission (group 1, class B) and immunity (industrial application)	
	RoHS directive	

1) Only for built-in transmitter

Optional approvals

Logo	Description	Country
	EU declaration of conformity ATEX directive Hazardous areas - Ex i Zone 0 gas II 1G Ex ia IIC T1 ... T6 Ga Zone 1 gas II 2G Ex ia IIC T1 ... T6 Gb Zone 1 mounting to zone 0 gas II 1/2G Ex ia IIC T1 ... T6 Ga/Gb Zone 20 dust II 1D Ex ia IIIC T125 ... T65 °C Da Zone 21 dust II 2D Ex ia IIIC T125 ... T65 °C Db Zone 21 mounting to zone 20 dust II 1/2D Ex ia IIIC T125 ... T65 °C Da/Db - Ex e ¹⁾ Zone 1 gas II 2G Ex eb IIC T1 ... T6 Gb ³⁾ Zone 2 gas II 3G Ex ec IIC T1 ... T6 Gc X Zone 21 dust II 2D Ex tb IIIC TX °C Db ³⁾ Zone 22 dust II 3D Ex tc IIIC TX °C Dc X - Ex n ¹⁾ Zone 2 gas II 3G Ex nA IIC T1 ... T6 Gc X - Ex t ¹⁾ Zone 22 dust II 3D Ex tc IIIC TX °C Dc X	European Union
	IECEx Hazardous areas - Ex i Zone 0 gas Ex ia IIC T1 ... T6 Ga Zone 1 gas Ex ia IIC T1 ... T6 Gb Zone 1 mounting to zone 0 gas Ex ia IIC T1 ... T6 Ga/Gb Zone 20 dust Ex ia IIIC T125 ... T65 °C Da Zone 21 dust Ex ia IIIC T125 ... T65 °C Db Zone 21 mounting to zone 20 dust Ex ia IIIC T125 ... T65 °C Da/Db - Ex e ²⁾ Zone 1 gas Ex eb IIC T1 ... T6 Gb ³⁾ Zone 2 gas Ex ec IIC T1 ... T6 Gc Zone 21 dust Ex tb IIIC TX °C Db ³⁾ Zone 22 dust Ex tc IIIC TX °C Dc - Ex n ²⁾ Zone 2 gas Ex nA IIC T1 ... T6 Gc - Ex t ²⁾ Zone 22 dust Ex tc IIIC TX °C Dc	International
	Ex Ukraine Hazardous areas - Ex i Zone 0 gas II 1G Ex ia IIC T1 ... T6 Ga Zone 1 gas II 2G Ex ia IIC T1 ... T6 Gb Zone 1 mounting to zone 0 gas II 1/2G Ex ia IIC T1 ... T6 Ga/Gb Zone 20 dust II 1D Ex ia IIIC T65°C Da Zone 21 dust II 2D Ex ia IIIC T65°C Db Zone 21 mounting to zone 20 dust II 1/2D Ex ia IIIC T65°C Da/Db	Ukraine
	INMETRO Hazardous areas - Ex i Zone 0 gas Ex ia IIC T3 ... T6 Ga Zone 1 mounting to zone 0 gas Ex ia IIC T3 ... T6 Ga/Gb Zone 20 dust Ex ia IIIC T125 ... T65 °C Da Zone 21 mounting to zone 20 dust Ex ia IIIC T125 ... T65 °C Da/Db	Brazil

Logo	Description	Country
	CCC³⁾ Hazardous areas - Ex i Zone 0 gas Ex ia IIC T1 ... T6 Ga Zone 1 gas Ex ia IIC T1 ... T6 Gb Zone 1 mounting to zone 0 gas Ex ia IIC T1 ... T6 Ga/Gb Zone 20 dust Ex ia IIIC T ₂₀₀ 65°C/T ₂₀₀ 95°C/T ₂₀₀ 125°C Da Zone 21 dust Ex ia IIIC T65°C/T95°C/T125°C Db Zone 21 mounting to zone 20 dust Ex ia IIIC T ₂₀₀ 65°C/T ₂₀₀ 95°C/T ₂₀₀ 125°C Da/Db Zone 21 dust Ex ib IIIC T65°C/T95°C/T125°C Db - Ex e ²⁾ Zone 1 gas Ex eb IIC T1 ... T6 Gb Zone 2 gas Ex ec IIC T1 ... T6 Gc	China
	NEPSI⁴⁾ Hazardous areas - Ex i Zone 0 gas Ex ia IIC T1 ~ T6 Gb Zone 1 gas Ex ia IIC T1 ~ T6 Ga/Gb Zone 1 mounting to zone 0 gas Ex iaD 20 T65/T95/T125°C Zone 20 dust Ex iaD 21 T65/T95/T125°C Zone 21 dust Ex iaD 20/21 T65/T95/T125°C Zone 21 mounting to zone 20 dust Ex nA IIC T1 ~ T6 Gc - Ex n ²⁾ Zone 2 gas	China
	KCs Hazardous areas - Ex i Zone 0 gas Ex ia IIC T4 ... T6 Zone 1 gas Ex ib IIC T4 ... T6	South Korea
-	PESO Hazardous areas - Ex i Zone 0 gas Ex ia IIC T1 ... T6 Ga Zone 1 gas Ex ia IIC T1 ... T6 Gb Zone 1 mounting to zone 0 gas Ex ia IIC T1 ... T6 Ga/Gb	India
	EAC Hazardous areas - Ex i Zone 0 gas 0 Ex ia IIC T6 ... T1 Ga X Zone 1 gas 1 Ex ia IIC T6 ... T1 Gb X Zone 20 dust Ex ia IIIC T80 ... T440 °C Da X Zone 21 dust Ex ia IIIC T80...T440 °C Db X - Ex n ¹⁾ Zone 2 gas 2 Ex nA IIC T6 ... T1 Gc X	Eurasian Economic Community
	PAC Ukraine Metrology, measurement technology	Ukraine
	PAC Kazakhstan Metrology, measurement technology	Kazakhstan
-	MchS Permission for commissioning	Kazakhstan
	PAC Uzbekistan Metrology, measurement technology	Uzbekistan
	DNV GL Type approval for the shipbuilding industry - Maximum insertion length l ₁ : 435 mm - Connection head: Model BSZ - Neck tube: Ø 11 x 2 mm or Ø 12 x 2.5 mm, max. 150 mm long - Measuring insert: Ø 6 mm - Optional with TW10-P (see data sheets TW 95.10, TW 95.12) <i>Location classification:</i> Temperature D (ambient temperature: -25 ... +70 °C) Humidity B (relative humidity: up to 100 %) Vibration B (frequency: 3 ... 25 Hz; amplitude: 1.6 mm peak; frequency: 25 ... 100 Hz; amplitude: 4 g) EMC Not relevant Case Required protection according to DNV rules shall be provided upon installation on board. For use on open deck a connection head IP68 is required. ⁵⁾ (for "open deck")	International

1) Only for connection head model BSZ, BSZ-H, 1/4000, 5/6000 or 7/8000 (see "Connection head")

2) Only with connection head, model 1/4000, 5/6000 or 7/8000 (see "Connection head")

3) Only without transmitter

4) Only with transmitter

5) Suitable cable gland required

Instruments marked with “ia” may also be used in areas only requiring instruments marked with “ib” or “ic”. If an instrument with “ia” marking has been used in an area with requirements in accordance with “ib” or “ic”, it can no longer be operated in areas with requirements in accordance with “ia” afterwards.



Explosion protection (option)

The permissible power, P_{max} , as well as the permissible ambient temperature, for the respective category can be seen on the Ex certificate or the operating instructions.

The transmitter have their own Ex certificates. The permissi-

ble ambient temperature ranges of the built-in transmitters can be taken from the corresponding transmitter operating instructions and approvals.

Manufacturer's information and certificates

Logo	Description
	SIL 2, SIL 3 see page 10 Functional safety
	NAMUR NE 024 Hazardous areas (Ex i)

Certificates (option)

Certification type	Measurement accuracy	Material certificate ¹⁾
2.2 test report	x	x
3.1 inspection certificate	x	x
DAkkS calibration certificate	x	-

1) Thermowells have their own material certificates for selected components

For calibration, the measuring insert is removed from the thermometer. The minimum length (metal part of the probe) for carrying out a 3.1 measurement accuracy test or DAkkS is 100 mm [~ 4 in].
Calibration of shorter lengths on request.

The different certifications can be combined with each other.

→ For approvals and certificates, see website

Dimensions

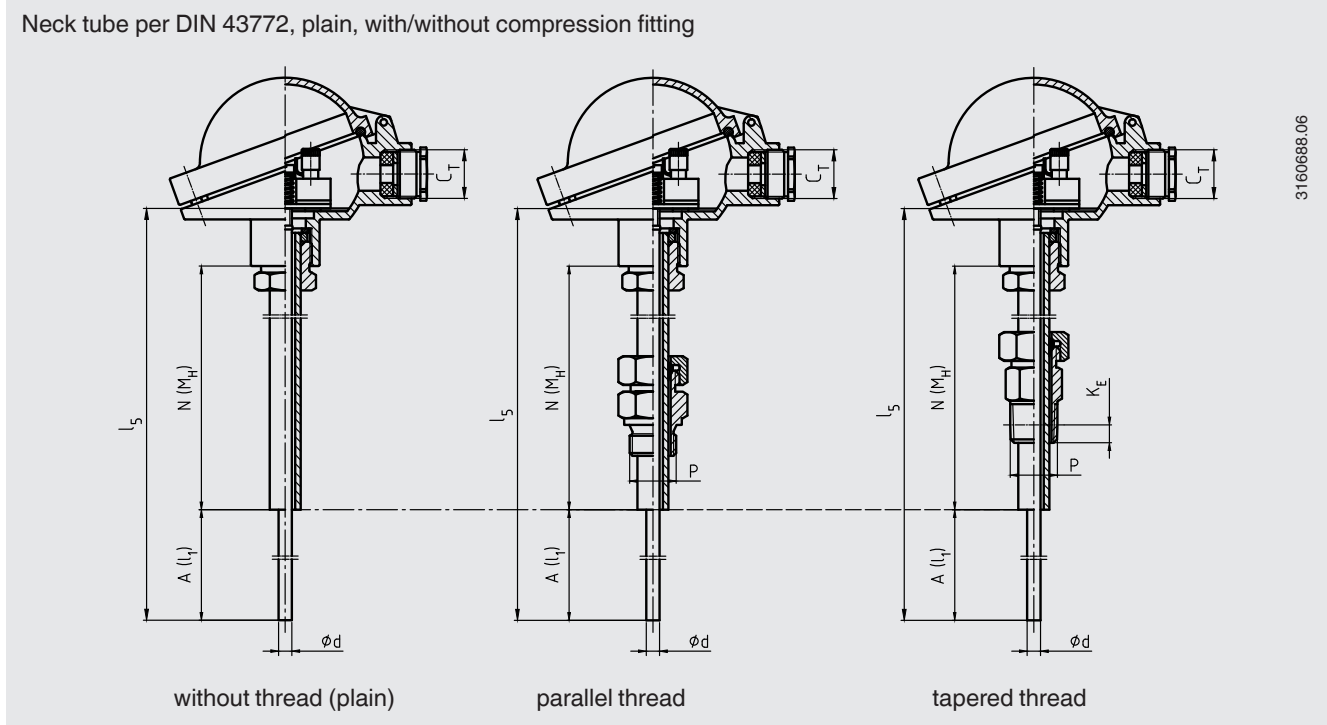
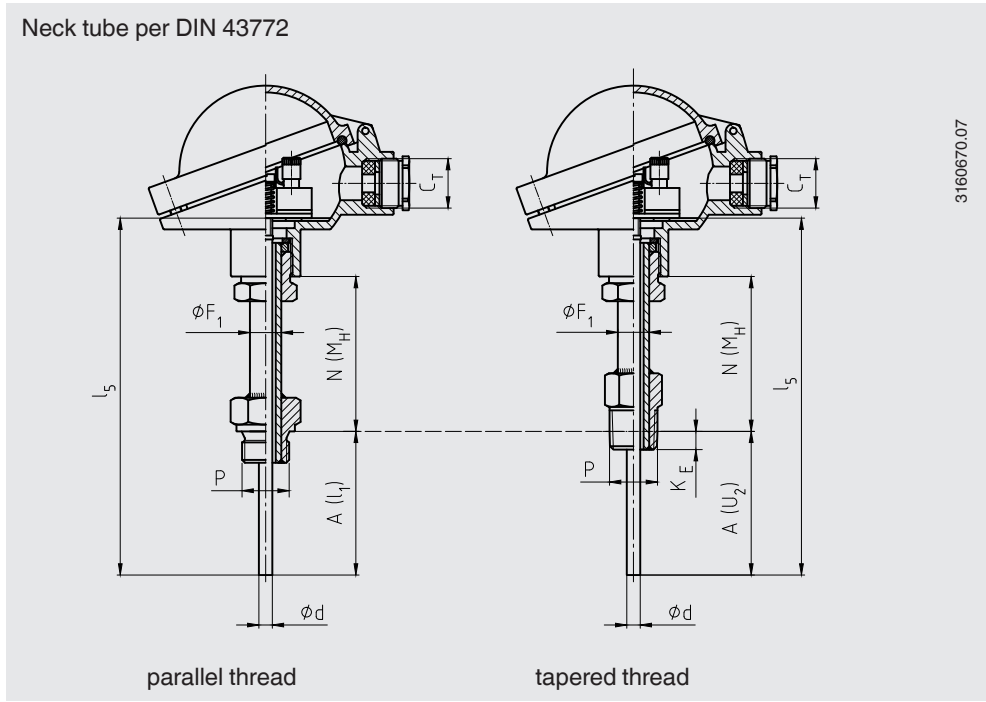

Legend:

- | | | | |
|-----------|--|------------|---------------------------|
| $A (I_1)$ | Insertion length (parallel threads) | C_T | Thread cable inlet |
| $A (U_2)$ | Insertion length (tapered threads) | ϕF_1 | Neck tube diameter |
| l_5 | Measuring insert length | P | Thread to the thermowell |
| $N (M_H)$ | Neck length | ϕd | Measuring insert diameter |
| K_E | 1/2 NPT: 8.13 mm [0.320 in]
3/4 NPT: 8.61 mm [0.339 in] | | |

The figures show examples of connection heads.

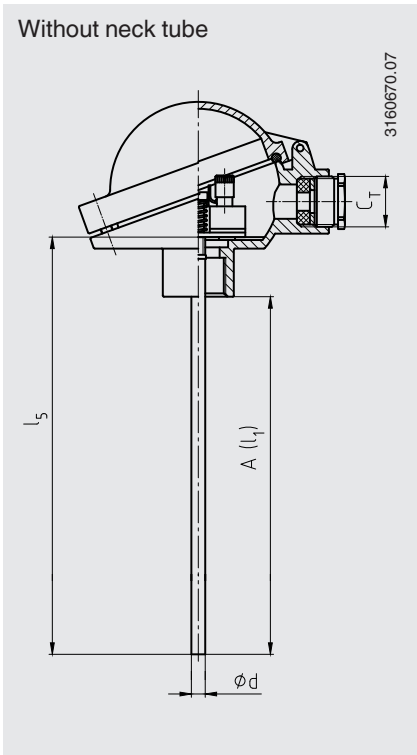
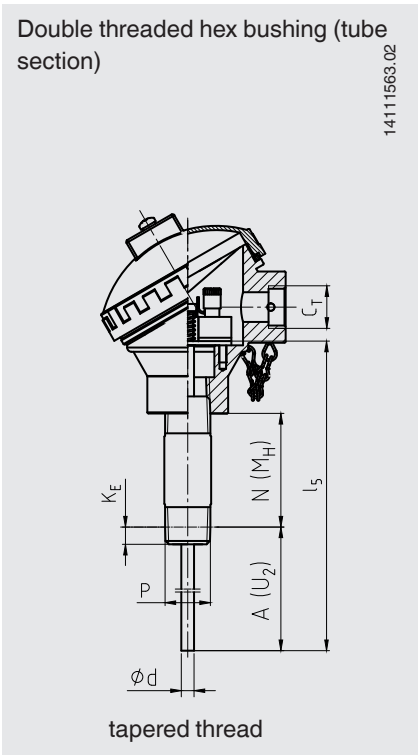
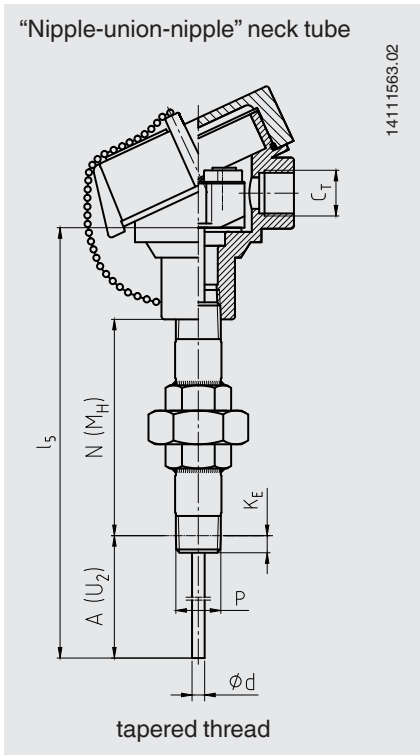
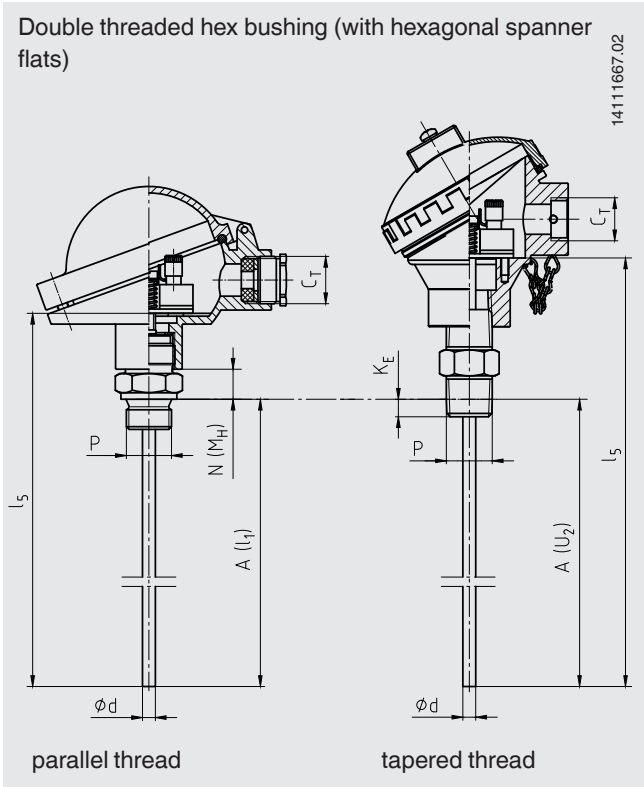
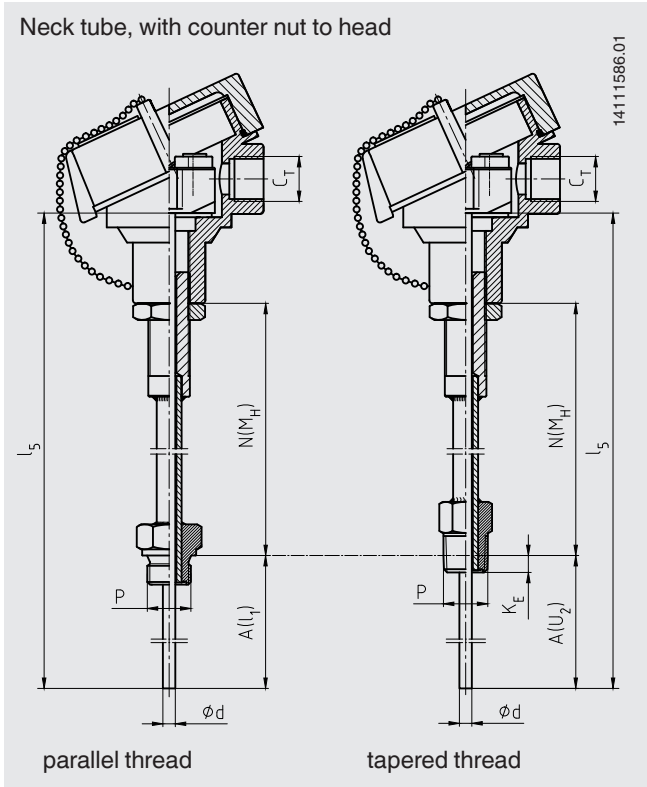

Legend:

- $A(l_1)$ Insertion length (parallel threads)
- $A(U_2)$ Insertion length (tapered threads)
- l_5 Measuring insert length
- $N(M_H)$ Neck length
- K_E $\frac{1}{2}$ NPT: 8.13 mm [0.320 in]
- $\frac{3}{4}$ NPT: 8.61 mm [0.339 in]

- C_T Thread cable inlet
- ϕF_1 Neck tube diameter
- P Thread to the thermowell
- ϕd Measuring insert diameter

The figures show examples of connection heads.

Ordering information

Model / Explosion protection / Further approvals, certificates / Sensor / Accuracy class, range of use of the sensor / Connection housing / Cable entry / Transmitter / Connection to neck tube / Neck tube / Thread size / Neck length N (M_H) / Insertion length A (I₁), A (U₂) / Measuring insert diameter Ø d / Measuring insert sheath material / Certificates / Options

© 04/2003 WIKA Alexander Wiegand SE & Co. KG, all rights reserved.
The specifications given in this document represent the state of engineering at the time of publishing.
We reserve the right to make modifications to the specifications and materials.

WIKA data sheet TE 65.02 · 02/2023

Seite 20 von 20

Your WIKA Sales Partner



ICS Schneider Messtechnik GmbH

Briesestrasse 59
D-16562 Hohen Neuendorf / OT Bergfelde
Tel.: +49 3303 5040-66
Fax: +49 3303 5040-68
E-Mail: info@ics-schneider.de



WIKA Alexander Wiegand SE & Co. KG
Alexander-Wiegand-Straße 30
63911 Klingenberg/Germany
Tel. +49 9372 132-0
info@wika.de
www.wika.de