

Threaded thermometer With integrated transmitter Model TFT35

WIKA data sheet TE 67.18



for further approvals
see page 4

Applications

- Machine building, plant and vessel construction
- Propulsion technology, hydraulics
- Heating and cooling circuits, air-conditioning technology

Special features

- Measuring ranges from -50 ... +200 °C [-58 ... +392 °F]
- Electrical connection via plug connection
- Output signal 4 ... 20 mA or 0 ... 10 V
- Factory configured
- Measuring insert exchangeable

Description

The model TFT35 threaded thermometer is used for temperature measurement of liquid and gaseous media in the range -50 ... +200 °C [-58 ... +392 °F].

It can be used for pressures up to 100 bar. All electrical components are protected against splash water and are designed to withstand vibration.

The thermowell with fixed threaded connection or adjustable compression fitting enables direct installation into the process. All wetted parts and also the case are from stainless steel.

The case and the exchangeable measuring insert are screwed together using a knurled nut. This enables the exchange of the measuring insert without having to remove the instrument from the process.



Fig. left: Angular connector DIN EN 175301-803
Fig. centre: Angular connector DIN EN 175301-803, compression fitting
Fig. right: Circular connector M12 x 1

Through the plug connection, simple installation of the transmitter is ensured.

The integrated electronics convert the temperature-dependent resistance signal of the measuring element into a linear unit signal. For the signal outputs, 4 ... 20 mA as well as 0 ... 10 V are available.

Specifications

Threaded thermometer, model TFT35		
Output signals	4 ... 20 mA	0 ... 10 V
Standard measuring ranges	<ul style="list-style-type: none"> ■ -50 ... +200 °C ■ -20 ... +120 °C ■ 0 ... 50 °C ■ 0 ... 100 °C ■ 0 ... 120 °C ■ 0 ... 150 °C ■ 0 ... 200 °C 	
Special measuring ranges		
Start of measuring range	-50 ... +50 °C	
End of measuring range	0 ... 200 °C	
Minimum span	50 K	
Accuracy		
Measuring element	±(0.3 + 0.005 * t) °C (class B per IEC 60751)	
Electronics	±0.5 % of measuring span	
	Overall accuracy = accuracy of measuring element + accuracy of electronics	
	Example: Medium temperature t = 150 °C, measuring range 0 ... 200 °C Accuracy: ±(0.3 + 0.005 * 150) + 0.5/100 * 200 = ±2.05 °C	
Power supply U_B	DC 10 ... 30 V	DC 12 ... 30 V
Max. permissible residual ripple	< 10 %	< 10 %
Error signalling		
Sensor break	> 20.5 mA	> 10.5 V
Sensor short-circuit	< 3.8 A	0 V

Thermowell		
Material	Stainless steel	
Diameter	<ul style="list-style-type: none"> ■ 6 mm ■ 8 mm 	
Process connection	Mounting thread, fixed Material: Stainless steel <ul style="list-style-type: none"> ■ G ¼ ■ G ⅜ ■ G ½ ■ G ¾ ■ M14 x 1.5 ■ ¼ NPT ■ ½ NPT 	Compression fitting, sliding Material: Stainless steel Material of ferrule: Stainless steel <ul style="list-style-type: none"> ■ G ¼ ■ G ½ ■ ¼ NPT ■ ½ NPT
Insertion length U₁	25, 50, 75, 100, 150, 200, 250, 300, 400, 500 mm	100, 150, 200, 250, 300, 400, 500 mm
Static operating pressure	Thermowell diameter 6 mm: max. 50 bar Thermowell diameter 8 mm: max. 100 bar	Max. 50 bar
Neck tube	<p>In order to protect the electronics from unacceptably high temperatures at higher temperatures and unfavourable installation situations, it is possible to separate the probe case from the process connection by means of a neck tube.</p> <p>With the version with compression fitting, the neck tube is 40 mm as standard so that the desired insertion length can be realised. The version with fixed mounting thread is delivered, as standard, without a neck tube. Here, a neck tube of 50 mm or 100 mm can be selected optionally.</p>	

Ambient conditions	
Working temperature	-50 ... +200 °C [-58 ... +392 °F]
Ambient temperature	-40 ... +85 °C [-40 ... +185 °F]
Storage temperature	-20 ... +70 °C [-4 ... +158 °F]
Vibration resistance ¹⁾	To 10 g per EN 60068-2-6
Shock resistance ¹⁾	To 100 g

Transmitter case	
Materials	Stainless steel
Diameter	27 mm
Electrical connection	<ul style="list-style-type: none"> ■ Angular connector DIN EN 175301-803, form A ■ Circular connector M12 x 1
Ingress protection	IP65

¹⁾ The values for vibration resistance and shock resistance apply for instruments with fixed, welded mounting threads.
Depending on the installation situation, medium, temperature and thermowell geometry, the vibration resistance and shock resistance can vary strongly.
We recommend, for increased demands, that the instrument is first tested in the application.

Dimensions in mm

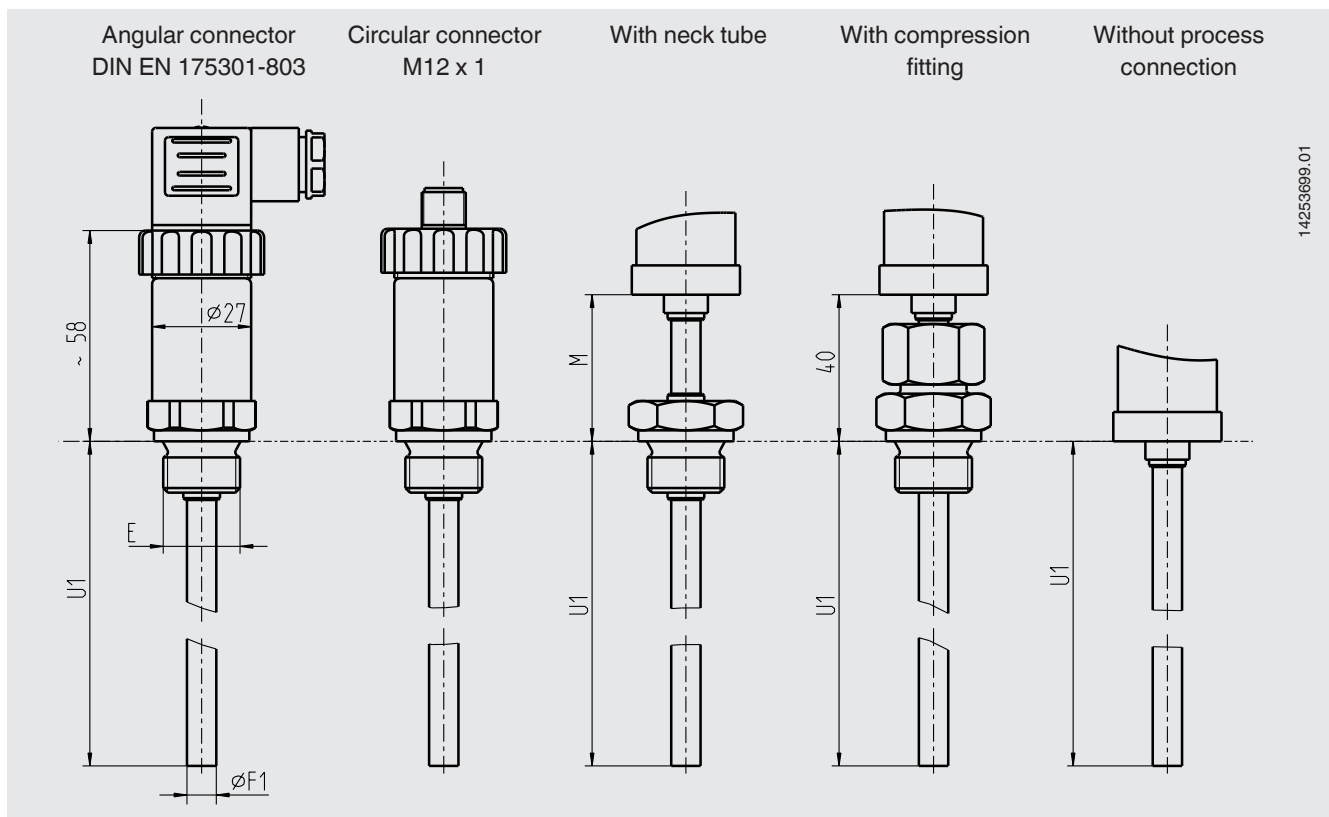

14256699.01

Legend:

- U₁ Insertion length
- ØF₁ Thermowell diameter
- M Neck tube length
- E Process connection

Electrical connection

■ Circular connector M12 x 1

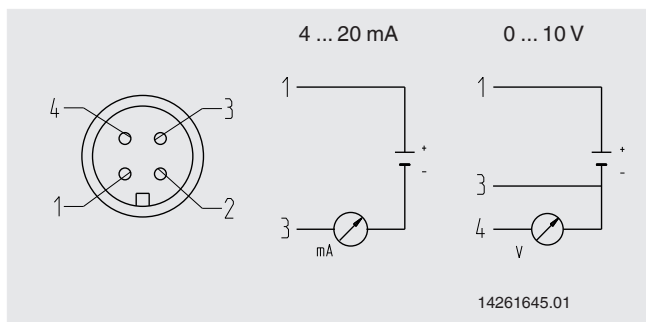

■ Angular connector DIN EN 175301-803, form A

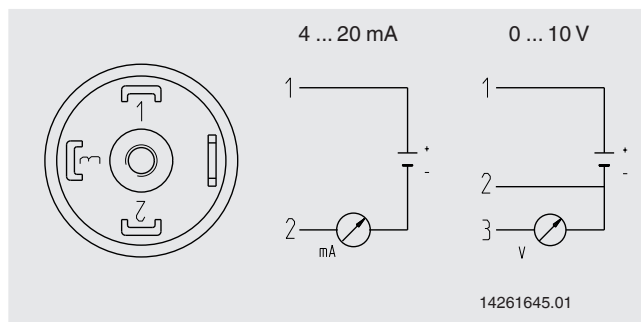

Approvals

Logo	Description	Country
	EU declaration of conformity <ul style="list-style-type: none"> ■ EMC directive EN 61326 emission (group 1, class B) and immunity (industrial application) ■ RoHS directive 	European Union
	EAC (option) <ul style="list-style-type: none"> ■ Import certificate ■ Pressure equipment directive ■ Machinery directive 	Eurasian Economic Community
	UkrSEPRO (option) Metrology, measurement technology	Ukraine

1) Use threaded thermometers with shielded cable, and, if the lines are longer than 30 m or leave the building, ground the shield on at least one end of the lead.

Approvals and certificates, see website

Ordering information

Model / Output signal / Start of measuring range / End of measuring range / Thermowell material / Thermowell diameter F_1 / Process connection E / Insertion length U_1 / Electrical connection / Neck length N / Options

© 01/2018 WIKA Alexander Wiegand SE & Co. KG, all rights reserved.
The specifications given in this document represent the state of engineering at the time of publishing.
We reserve the right to make modifications to the specifications and materials.