

Bimetal thermometer Process version per EN 13190 Model TG54

WIKA data sheet TM 54.02



for further approvals
see page 9

Applications

- General process instrumentation in the chemical and petrochemical industries, oil and gas industries, power generation and water/wastewater industries
- Temperature measurement in harsh and aggressive environments
- Suitable for applications with high vibrations

Special features

- Nominal sizes 63, 80, 100, 160 mm
- Robust, hermetically sealed case
- External reset for setting the reference temperature
- Dished dial (anti-parallax) for ease of reading
- Adjustable stem and dial version enables optimal process connection



Fig. left: Back mount (axial)

Fig. right: Back mount, adjustable stem and dial

Description

The model TG54 bimetal thermometer has been developed and is manufactured in accordance with the EN 13190 standard. The thermometer meets the high requirements of the process industries.

Especially in the chemical and petrochemical, oil and gas, power engineering and shipbuilding industries, the temperature measuring instrument manufactured from stainless steel is used successfully. The robust, hermetically sealed case with IP65 ingress protection enables use with harsh external conditions and high vibration.

With a count of four different nominal sizes, an optimal matching to the available space and mounting conditions is possible.

At an easily accessible point on the back of the case, the zero point can be easily corrected.

The model TG54 meets the high requirements for resistance against aggressive media. As an option, the case, the stem and the process connection can be made from 316L.

Specifications

Detailed views

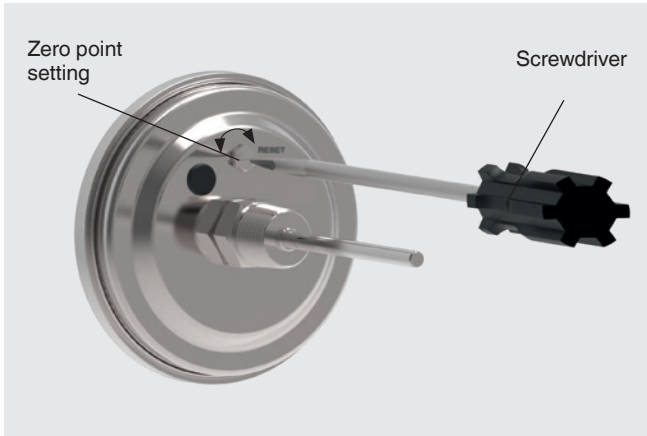
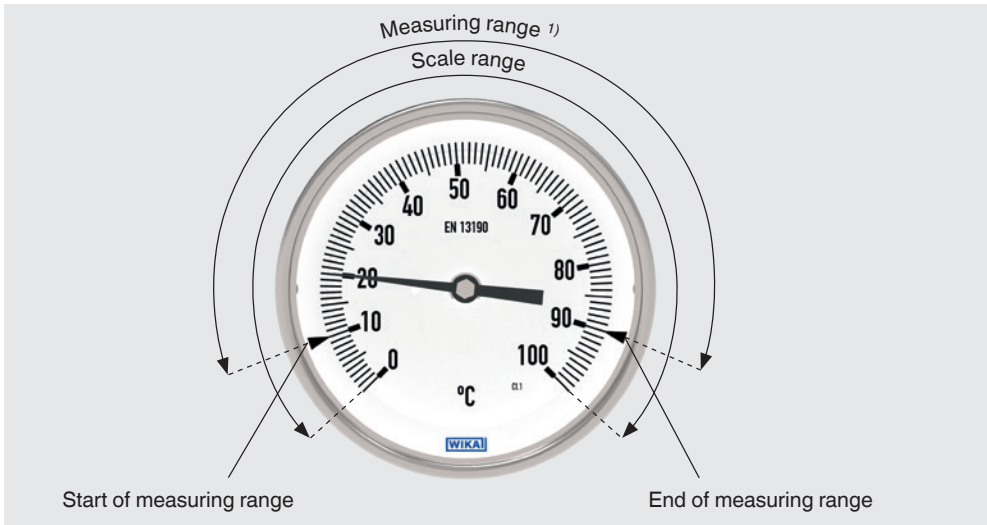

1) Only within the measuring range will the printed accuracy class (class 1 or 2) be guaranteed.

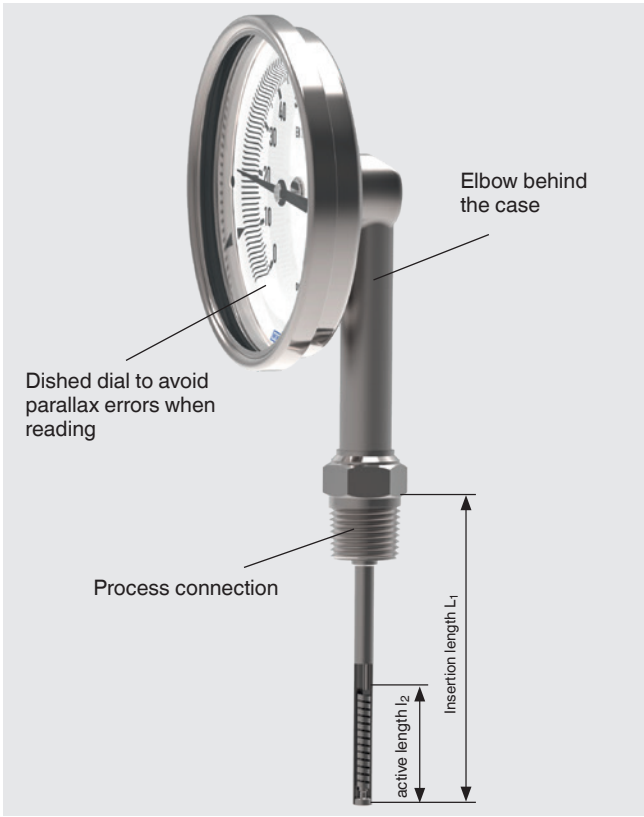

Basic information	
Standard	EN 13190
Nominal size in mm [in]	<ul style="list-style-type: none"> ■ 63 [2"] ■ 80 [3"] ■ 100 [4"] ■ 160 [6"]
Window	<ul style="list-style-type: none"> ■ Instrument glass ■ Laminated safety glass ■ Polycarbonate (shatterproof)
Connection location	<ul style="list-style-type: none"> ■ Back mount (axial) ■ Lower mount (radial) ■ Back mount, adjustable stem and dial
Connection design	→ For drawings, see page 10
S	Standard (male threaded connection)
1	Plain stem (without thread)
2	Male nut
3	Union nut
4	Compression fitting (sliding on stem)
4.1	Compression fitting with support tube sliding on stem
Versions	<ul style="list-style-type: none"> ■ Standard version ■ Oil- and grease-free version ■ Silicone-oil-less version
Dampening, case filling	<ul style="list-style-type: none"> ■ Without ■ With silicone oil case filling, up to max. 250 °C [482 °F] (at the probe)
Material (in contact with the environment)	
Case, ring	<ul style="list-style-type: none"> ■ Stainless steel 304 ■ Stainless steel 316L
Elbow behind the case (only with lower mount)	<ul style="list-style-type: none"> ■ Stainless steel 304 ■ Stainless steel 316L

Measuring element	
Type of measuring element	Bimetal coil
Nominal effective range	
Continuous load (1 year)	Measuring range (EN 13190)
Short time (max. 24 h)	Scale range (EN 13190)

Accuracy specifications	
Accuracy	Class 1 per EN 13190



Scale range in °C	Measuring range ¹⁾ in °C	Scale interval in °C
-70 ... +70	-50 ... +50	2
-70 ... +30	-60 ... +20	1
-60 ... +50	-50 ... +40	1
-50 ... +50	-40 ... +40	1
-50 ... +100	-30 ... +80	2
-50 ... +200	-20 ... +170	5
-50 ... +300	0 ... 250	5
-50 ... +400	0 ... 350	5
-50 ... +500	0 ... 450	10
-40 ... +40	-30 ... +30	1
-40 ... +60	-30 ... +50	1
-40 ... +80	-20 ... +60	2
-40 ... +160	-20 ... +140	2
-30 ... +30	-20 ... +20	1
-30 ... +50	-20 ... +40	1
-30 ... +70	-20 ... +60	1
-20 ... +40	-10 ... +30	1
-20 ... +60	-10 ... +50	1
-20 ... +80	-10 ... +70	1
-20 ... +100	0 ... 80	2
-20 ... +120	0 ... 100	2
-20 ... +140	0 ... 120	2
-10 ... +50	0 ... 40	1
0 ... 60	10 ... 50	1
0 ... 80	10 ... 70	1
0 ... 100	10 ... 90	1
0 ... 120	10 ... 110	2
0 ... 160	20 ... 140	2
0 ... 200	20 ... 180	2
0 ... 250	30 ... 220	5
0 ... 300	30 ... 270	5
0 ... 400	50 ... 350	5
0 ... 500	50 ... 450	5
0 ... 600	100 ... 500	5

Scale range in °F	Measuring range ¹⁾ in °F	Scale spacing in °F
-100 ... +150	-70 ... +120	5
-80 ... +120	-40 ... +100	2
-80 ... +240	-50 ... +210	5
-40 ... +120	-20 ... +100	2
0 ... 140	20 ... 120	2
0 ... 200	20 ... 180	2
0 ... 250	30 ... 220	5
30 ... 300	60 ... 270	2
30 ... 400	80 ... 350	5
50 ... 400	100 ... 350	5
100 ... 800	200 ... 700	10
150 ... 750	200 ... 700	5
200 ... 1,000	300 ... 900	10

1) The measuring range is indicated on the dial by two triangular marks. Only within this range is the stated error limit valid per EN 13190.

Further details on: Scale range		
Unit	<ul style="list-style-type: none"> ■ °C ■ °F ■ °C/°F (dual scale) ■ °F/°C (dual scale) 	
Overtemperature stability ¹⁾		
Scale range -70 ... +120 °C [-94 ... +250 °F]	100 % overload safety of scale range	
Scale range 120 ... 280 °C [250 ... 550 °F]	50 % overload safety of scale range	
Scale range 280 ... 400 °C [550 ... 750 °F]	max. 430 °C [800 °F] of scale range	
Scale range 400 ... 600 °C [750 ... 1,000 °F]	max. full scale value	
Dial		
Scale graduation	<ul style="list-style-type: none"> ■ Single scale ■ Dual scale 	
Scale colour	Single scale	Black
	Dual scale	Red
		Others on request
Material	Aluminium	
Pointer		
Version	Adjustable pointer	
Pointer colour	Black	
Material	Aluminium	

1) Overtemperature stability only in non-hazardous areas

Process connection	
Thread size	<ul style="list-style-type: none"> ■ Plain, without thread ■ G ½ B ■ ½ NPT ■ G ½ B female ■ ½ NPT female ■ M20 x 1.5 ■ M24 x 1.5 female <p>Others on request</p>
Material (wetted)	<ul style="list-style-type: none"> ■ Stainless steel 304 ■ Stainless steel 316L
Stem	
Diameter	<ul style="list-style-type: none"> ■ 6 mm [0.24 in] ■ 8 mm [0.31 in]
Material (wetted)	<ul style="list-style-type: none"> ■ Stainless steel 304 ■ Stainless steel 316L
Thermowell/protection tube	<p>In principle, the operation of a mechanical thermometer is possible without a thermowell/protection tube with low process-side loading (low pressure, low viscosity and low flow velocities).</p> <p>However, in order to enable exchanging the thermometer during operation (e.g. instrument replacement or calibration) and to ensure a better protection of the instrument and also the plant and the environment, it is advisable to use a thermowell/protection tube from the extensive WIKA portfolio.</p> <p>→ For further information on the wake frequency calculation, see Technical information IN 00.15.</p>
Model TW10	 <ul style="list-style-type: none"> → see data sheet TW 95.10 → see data sheet TW 95.11 → see data sheet TW 95.12
Model TW15	 <ul style="list-style-type: none"> → see data sheet TW 95.15

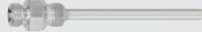
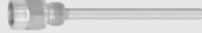
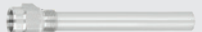
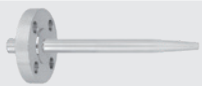
Process connection		
Model TW25		→ see data sheet TW 95.25
Model TW45	 	→ see data sheet TW 95.45
Model TW50		→ see data sheet TW 95.50
Model TW55		→ see data sheet TW 95.55
Special thermowells on request		

Operating conditions			
Ambient temperature range (at the case)	unfilled	filled	Option
Instrument glass	-40 ... +100 °C ¹⁾ [-40 ... +212 °F]	-40 ... +70 °C [-40 ... +160 °F]	-50 ... +70 °C [-60 ... +160 °F]
Laminated and polycarbonate window	-40 ... +70 °C ¹⁾ [-40 ... +160 °F]	-40 ... +70 °C [-40 ... +160 °F]	-50 ... +70 °C [-60 ... +160 °F]
Storage temperature range			
Without liquid dampening	-50 ... +70 °C [-60 ... +160 °F]		
With liquid dampening	-40 ... +70 °C [-40 ... +160 °F]		
Max. operating pressure at stem	Max. 25 bar, static		
Ingress protection (IP code) per IEC/EN 60529	<ul style="list-style-type: none"> ■ IP65 ■ IP66 ■ IP67 ■ IP68 (continuous immersion to 5 m) 		
Insertion length L ₁	63 ... 1,000 mm [2.5 ... 39 in]		
	Minimum/maximum length is dependent on the measuring range and diameter → see table on page 7		

1) With ambient temperatures < 0 °C [< 32 °F] the measuring system and the window can fog and possibly even frost up.

Minimum insertion length in mm						
Scale range in °C	Connection location					
	Back mount		Lower mount		Back mount, adjustable stem and dial	
	Ø 6	Ø 8	Ø 6	Ø 8	Ø 6	Ø 8
-70 ... +70	80	63	80	80	80	80
-70 ... +30	90	80	100	90	100	90
-60 ... +50	90	80	100	90	100	90
-50 ... +50	90	80	90	80	90	80
-50 ... +100	80	63	90	80	90	80
-50 ... +200	80	80	90	80	90	80
-50 ... +300	125	125	125	125	125	125
-50 ... +400	125	125	125	125	125	125
-50 ... +500	125	125	125	125	125	125
-40 ... +40	100	90	125	100	125	100
-40 ... +60	90	80	90	80	90	80
-40 ... +80	90	80	90	80	90	80
-40 ... +160	80	63	80	63	80	63
-30 ... +30	125	100	125	125	125	125
-30 ... +50	90	80	100	90	100	90
-30 ... +70	90	80	100	90	100	90
-20 ... +40	125	90	125	100	125	100
-20 ... +60	90	80	100	90	100	90
-20 ... +80	80	80	90	80	90	80
-20 ... +100	80	63	80	80	80	80
-20 ... +120	80	63	80	80	80	80
-20 ... +140	80	63	80	80	80	80
-10 ... +50	125	90	125	100	125	100
0 ... 60	125	90	125	100	125	100
0 ... 80	90	80	100	90	100	90
0 ... 100	80	63	100	80	100	80
0 ... 120	80	63	80	80	80	80
0 ... 160	63	63	80	63	80	63
0 ... 200	63	63	63	63	63	63
0 ... 250	80	80	90	80	90	80
0 ... 300	125	125	125	125	125	125
0 ... 400	125	125	125	125	125	125
0 ... 500	125	125	125	125	125	125
0 ... 600	125	125	125	125	125	125

Notes:

- Optionally with 2nd scale °C/°F or °F/°C
- The minimum insertion lengths of 100 mm [3.94 in] and 125 mm [4.92 in] are valid for ≤ 15 pieces per order.
For larger lot sizes (> 15 pieces), as a variation to the standard minimum insertion lengths, other lengths can be requested.







Minimum insertion length in mm						
Scale range in °F	Connection location					
	Back mount		Lower mount		Back mount, adjustable stem and dial	
	Ø 6	Ø 8	Ø 6	Ø 8	Ø 6	Ø 8
-100 ... +150	90	80	90	90	90	90
-80 ... +120	90	80	100	90	100	90
-80 ... +240	90	80	90	80	90	80
-40 ... +120	100	90	125	100	125	100
0 ... 140	90	80	100	90	100	90
0 ... 200	125	125	125	125	125	125
0 ... 250	80	63	80	80	80	80
30 ... 300	80	63	80	80	80	80
30 ... 400	63	63	63	63	63	63
50 ... 400	63	63	63	63	63	63
100 ... 800	125	125	125	125	125	125
150 ... 750	125	125	125	125	125	125
200 ... 1,000	125	125	125	125	125	125

Notes:

- Optionally with 2nd scale °C/°F or °F/°C
- The minimum insertion lengths of 100 mm [3.94 in] and 125 mm [4.92 in] are valid for ≤ 15 pieces per order.
For larger lot sizes (> 15 pieces), as a variation to the standard minimum insertion lengths, other lengths can be requested.

Approvals

Optional approvals

Logo	Description	Country
	EU declaration of conformity ATEX directive Hazardous areas - Ex h Zone 1 gas II 2G Ex h IIC T6 ... T1 Gb X Zone 20 dust II 2D Ex h IIIC T85 ... T450 °C Db X	European Union
	GOST Metrology, measurement technology	Russia
	KazInMetr Metrology, measurement technology	Kazakhstan
-	MTSCHS Permission for commissioning	Kazakhstan
	BelGIM Metrology, measurement technology	Belarus
	Uzstandard Metrology, measurement technology	Uzbekistan
-	CRN Safety (e.g. electr. safety, overpressure, ...)	Canada
	DNV GL Type approval for the shipbuilding industry - Nominal size: 63 mm [2"], 80 mm [3"], 100 mm [4"] - Dampening: With liquid dampening - Maximum insertion length: 500 mm [19.69 in] Location classification: Humidity DNVGL-CG-0339, section 3, class B Salt fog DNVGL-CG-0339, section 3, class D Vibration DNVGL-CG-0339, section 3, class B Use of a thermowell/protection tube is mandatory.	International

Certificates (option)

Certificates	
Certificates	<ul style="list-style-type: none"> ■ 2.2 test report ■ 3.1 inspection certificate with 3 test points (optionally with 5 test points)

Approvals and certificates, see website

Connection designs

Standard design (male threaded connection)

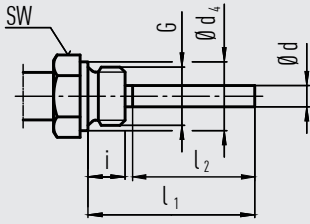

Standard insertion length $l_1 = 100, 160, 200, 250$ mm
 Recommendation: For applications with vibration on the process side

Nominal size	Process connection		Dimensions in mm		
	G	i	SW	d_4	$\varnothing d$
NS	G	i	SW	d_4	$\varnothing d$
63, 80, 100, 160	G ½ B	14	27	26	■ 6 ■ 8
	½ NPT	19	22	-	■ 6 ■ 8

Design 1, plain stem (without thread)

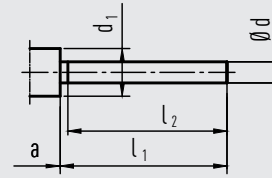

Standard insertion length $l_1 = 100, 140, 160, 200, 240, 290$ mm
 Basis for design 4, compression fitting

Nominal size	Dimensions in mm			
NS	d_1	$\varnothing d$	a for axial	a for adjustable stem and dial
63, 80, 100, 160	18	8	28	30

3073050.06

Design 2, male nut

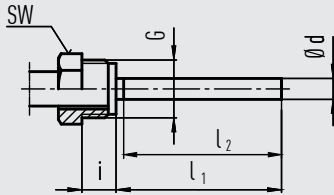

Standard insertion length $l_1 = 140, 180, 230$ mm
 Non-sealing process connection, thus use with thermowell/ protection tube.

Nominal size	Process connection		Dimensions in mm	
	G	i	SW	$\varnothing d$
NS	G	i	SW	$\varnothing d$
63, 80, 100, 160	G ½ B	20	27	■ 6 ■ 8
	M18 x 1.5	17	22	■ 6 ■ 8

Design 3, union nut

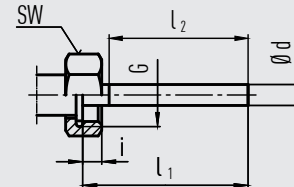

Standard insertion length $l_1 = 126, 186, 226, 276$ mm

Nominal size	Process connection		Dimensions in mm	
NS	G	i	SW	$\varnothing d$
63, 80, 100, 160	G ½ B	8.5	27	■ 6 ■ 8
	M24 x 1.5	13.5	32	■ 6 ■ 8

3073050.06

Design 4, compression fitting (sliding on stem)

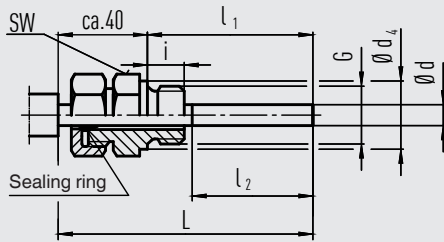

Insertion length l_1 = variable
 Length $L = l_1 + 40$ mm

Nominal size	Process connection		Dimensions in mm			
	G	i	SW	d ₄	Ø d	
NS						
63, 80, 100, 160	G ½ B	14	27	26	■ 6 ■ 8	
	½ NPT	19	22	-	■ 6 ■ 8	

Design 4.1, compression fitting with support tube sliding on stem

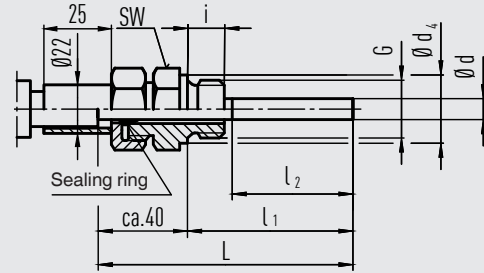

Standard insertion length $l_1 = 63, 100, 160, 200, 250$ mm
 Length $L = l_1 + 40$ mm

Nominal size	Process connection		Dimensions in mm			
	G	i	SW	d ₄	Ø d	
NS						
63, 80, 100, 160	G ½ B	14	27	26	■ 6 ■ 8	
	½ NPT	19	22	-	■ 6 ■ 8	

Legend:

- G Male thread
- G₁ Female thread
- i Thread length (incl. collar)
- a Distance to the case/articulated joint
- Ø d₄ Diameter of the sealing collar
- SW Spanner width
- Ø d Stem diameter
- l₂ Active length

Dimensions in mm

Back mount (axial)

G thread

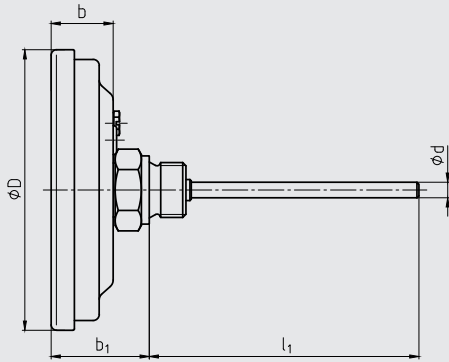

14183333.01

NPT thread

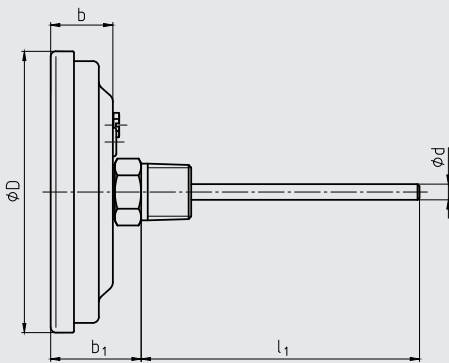

Lower mount (radial)

G thread

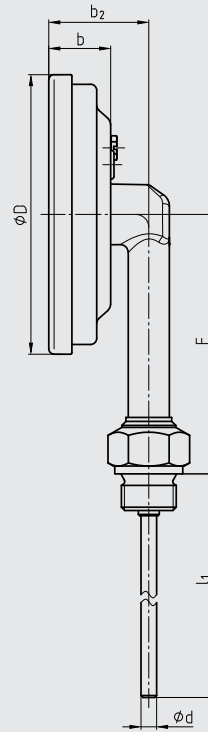

NPT thread

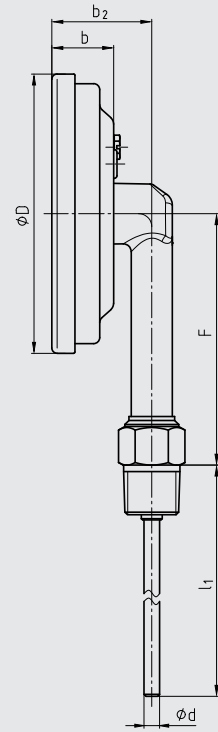

14183334.02

Nominal size	Dimensions in mm								
	NS	Ø D	Ø d	b	b ₁ ¹⁾		b ₂	F	
					G thread	NPT thread		G thread	NPT thread
63	70	6	24	45	38	39	81	77	
			8						
80	83	6	23	44	37	38	88	84	
		8							
100	107	6	24	45	38	39	100	95	
		8							
160	167	6	24	45	38	39	130	125	
		8							

1) With scale ranges $\geq 0 \dots 300$ °C the dimensions increase by 40 mm

Back mount, adjustable stem and dial

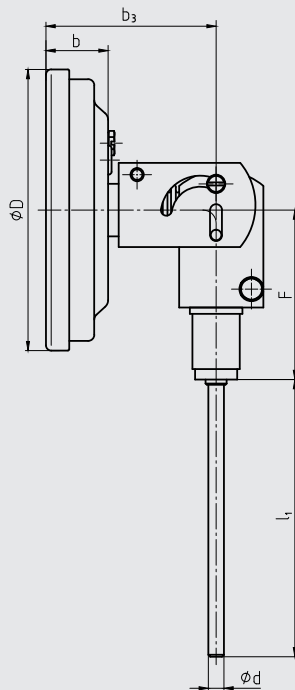

14183335.02

Nominal size	Dimensions in mm				
NS	Ø D	Ø d	b	b ₃	F
63	70	■ 6	24	65	67
		■ 8			
80	83	■ 6	23	64	67
		■ 8			
100	107	■ 6	24	65	67
		■ 8			
160	167	■ 6	24	65	67
		■ 8			

Ordering information

Model / Nominal size / Connection location / Connection design / Unit / Scale range / Process connection / Stem diameter / Insertion length l_1 / Approvals / Certificates / Options

© 10/2018 WIKA Alexander Wiegand SE & Co. KG, all rights reserved.
The specifications given in this document represent the state of engineering at the time of publishing.
We reserve the right to make modifications to the specifications and materials.